

A collection of wireframe illustrations of various tools, including wrenches, sockets, and a screwdriver, arranged diagonally across the page. One wrench handle has '19' written on it, and another has 'DINABETA ZERO-RESET' and 'LORDS' written on it. A screwdriver handle in the foreground has 'PIBETA' written on it.

PRIJSLIJST 2024

Geldig tot 28/02/2025
Excl. BTW



Beta
Benelux B.V.

BELDER 9-B
4704 RK ROOSENDAAL
TEL: 0165.534761
FAX: 0165.534791
E-MAIL: info@betabenelux.nl

BETA BETEKENT
DURF. BETROKKENHEID. HARMONIE. TALENT.



Bij Beta is er maar één manier om de dingen te doen: doe ze goed.

Dit is de wereld van Beta, dit is het principe dat ons dagelijks werk over de hele wereld leidt, gedreven door vier waarden:

DURF om te investeren en te vernieuwen. Een onderneming gecreëerd door een Italiaanse vakman in 1923, die zich wereldwijd heeft laten gelden en na vier generaties nog steeds groeit;

BETROKKENHEID omdat elke verkoper weet dat hij kan rekenen op een betrouwbare en tijdige service en elke gebruiker weet dat hij kan vertrouwen op de precisie, kwaliteit en weerstand van Beta-producten

HARMONIE Niet standaard, maar met een design van uitmuntendheid, want als iets goed is gedaan, creëert het een perfecte balans tussen functie en design.

TALENT het is onze meest waardevolle hulpbron, degene die al onze mensen en elke professional onderscheidt die Beta kiest om niets aan het toeval over te laten, in de boeiende en gepassioneerde vervulling van hun ideeën en dromen.



INDEX



Index.....	4
Verklaring van de symbolen	8
Gebruiksmogelijkheden voor momentsleutels en torsiesleutels	58-59
Overzicht gereedschapswagens en assortimenten	351, 479-480
Verwijderd artikel – Vervangend/ aanbevolen artikel	727÷729
Alfabetische index.....	730÷734
Index automobiel gereedschappen	735÷737
Alfanumerische index	738÷753
Beta-groep – belangrijkste feiten	754
De geschiedenis van Italiaanse gereedschappen	755
Certified quality	756
Controle en kwaliteit	757
Logistiek.....	758
Werkplaats inrichting	759
Effectieve aanwezigheid.....	760

INDEX

WERKPLAATSINRICHTING **RSC55**



RSC55

410÷435; 475÷478

WERKPLAATSINRICHTING **RSC50**



Beta
RSC50

436÷453; 475÷478

WERKPLAATSINRICHTING **C45PRO**



Beta
C45PRO

454÷478

OPBERGSSYSTEEMEN EN ASSORTIMENTEN



351÷370



371÷400



383; 401÷409



479÷561

SLEUTELS



11÷17

23÷27

112÷117

DOPSLEUTELS EN TOEBEHOREN



69÷78

85÷112

MOMENTSLEUTELS EN KRACHTVERMEERAAERS



54÷56

57÷69

SCHROEVENDRAIERS, STIFSLEUTELS EN BITS



18÷23

78÷85

114÷117

145÷159

TANGEN EN KNIPTANGEN

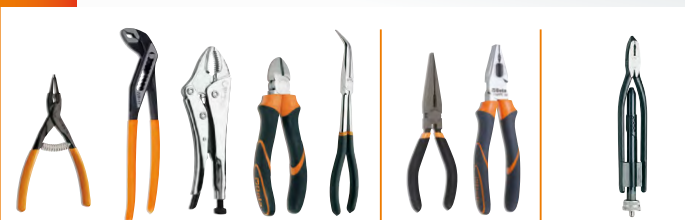

127÷134

139÷142

236

HAMERS EN BEITELS



9-10

166÷170

217÷218

VERLICHTING



242÷247

BOREN EN TAPPEN



36÷41

41÷43

44÷51

51÷53

HASPELS



247÷249; 347

TREKKERS

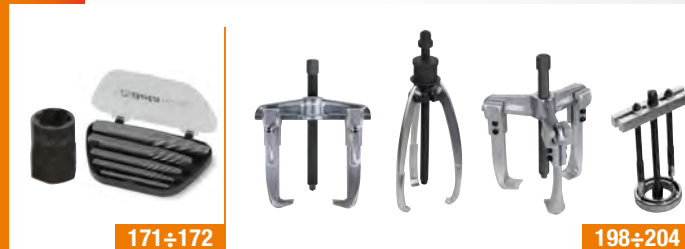

171÷172

198÷204

LOODGIETER EN INSTALLATEUR GEREEDSCHAPPEN



27÷35

MEET EN MARKEER GEREEDSCHAPPEN



210÷217

ELEKTRONICA EN MICRO-ELEKTROTECHNIEK



126-127

142÷144

148÷151

ALGEMENE EN SNIJGEREEDSCHAPPEN



122÷123

134÷136

158÷159

184

ELEKTRO TECHNIEK



136÷139

150

585÷587

232÷236

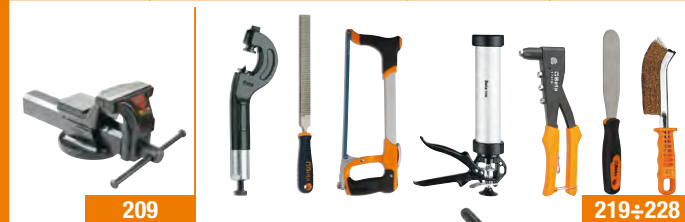

209

219÷228

LASGEREEDSCHAPPEN



250÷254



238÷241

325÷326

GEISOLEERD GEREEDSCHAP 1000V



285÷291

GEREEDSCHAPPEN VERVAARDIGD UIT ROESTVAST STAAL



299÷303

VONKVRIJE GEREEDSCHAPPEN



304÷312

GARAGE EN AUTOHERSTEL GEREEDSCHAP



118÷125

160÷166



170÷198; 204÷208

229÷232

232÷238

WERKPLAATS EQUIPMENT



254÷273

MOTORFIETS GEREEDSCHAP



274÷279

FIETS GEREEDSCHAP



280÷284

ACCU GEREEDSCHAP



313÷324

PERSLUCHTGEREEDSCHAP EN TOEBEHOREN



327÷350

GEREEDSCHAP MET VALBEVEILIGING



292÷298

BETA CHEMICALS



562÷567

VEILIGHEIDSSCHOENEN (EN SOKKEN)



624÷649

BETA ABRASIVES



568÷584

WERKKLEDING



650÷670

PRODUCTEN ONDER DE MERKNAMEN BM



588÷594

ASSORTIMENT IN BLISTER VERPAKKING



595÷609

ROBUR TOEBEHOREN VOOR DRAAD EN KABEL

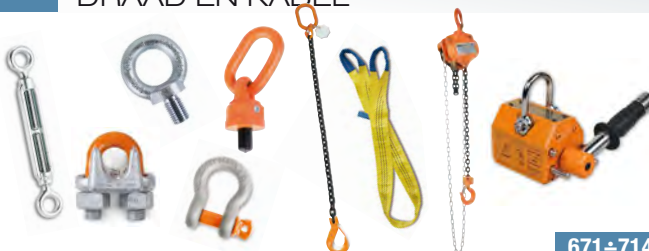

671÷714

VERKOOPWANDEN EN TOEBEHOREN

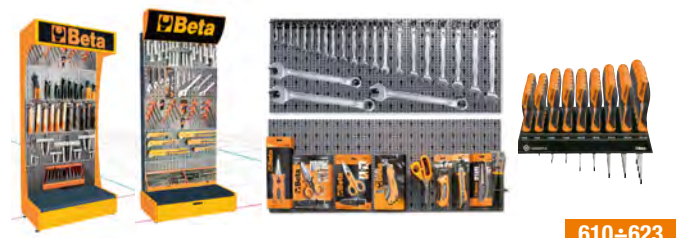

610÷623

BETA COLLECTION



715÷726

VERKLARING VAN DE SYMBOLEN

Artikel nummer **951GP**

Klucze trzpieniowe typu T z jedną końcówką sześciokątną
 Klucz 951GP Beta oznacza szybkość pracy i dokładność dopasowania do śruby. Zaprojektowany tak, aby spełniać kluczowe wymagania świata wyścigów: przenoszenie wysokich momentów i zapewnienie szybkiego dokręcania.

gereedschap profiel 

prijs per stuk

★ item is leverbaar op verzoek
 • belangrijkste afmeting
 ○ zeskant aandrijfkant

afmeting

mm	L mm	L1 mm	Ø mm	€	code nummer
3	185	130	5	19,00	3 009511530
4	214	150	5	20,00	3 009511540
5	240	165	6	23,00	3 009511550
6	271	180	7	27,00	3 009511560
8	300	200	10	34,00	3 009511580
10	310	200	12	42,00	3 009511610

verpakkingseenheid

aantal stuks

samenstellingsteken

set bevat

951GP/S6
 3-4-5-6-8-10 mm € 165,00 1 009511687

code nummer

nieuwe artikelen 2024



In blisterverpakking

Motorfiets gereedschap



Fiets gereedschap



Meest gebruikte symbolen

Meest gebruikte symbolen	Voorbeeld
Sets	
B = in kunststof etui	42/B9N
BV = lege etui	2002/BV9
C = in metalen kist	900/C11
D = verpakking om op te hangen	1293/D6
S = in doos	42/S17
SP = met display	42/SP25
SPV = leeg display	42/SPV7
SC = geleverd met compacte houder	96/SC9
SCV = compacte houder, leeg	96/SCV

Meest gebruikte symbolen	Voorbeeld
Assortimenten	
AS = gereedschap in inch maten	5915VU/AS
E = Elektrotechniek/Elektronica	5980ET/A
I = Loodgieters gereedschap	5980ID
MT = Grondverzet	5902MT
U = Universeel gereedschap	5915VU/3
SBK = onderhoud aan wegmotoren	5940SBK
VG = Automobiel techniek	5904VG/5T
VI = Industrie	5902VI

Meest gebruikte symbolen	Voorbeeld
Dopsleutels	
A = Zeskant profie	910A
B = Twaalfkant profiel	910B
ES = speciaal groefprofiel	920ES
FTX = voor TORX® profiel	910FTX

Meest gebruikte symbolen

Meest gebruikte symbolen	Voorbeeld
PT = voor 5 ster kopschroeven	910PT
X = Omschakelbare ratel in kist	920A/C12X

Meest gebruikte symbolen	Voorbeeld
Schroevendraaiers en bits	
LP = voor sleufschroeven	920LP
PE = voor binnenzeskant schroeven	920PE
PH = voor kruiskopschroeven PHILLIPS®	920PH
PZ = voor kruiskopschroeven POZIDRIV® - SUPADRIV® schroeven	1299PZ
RTX = voor TAMPER RESISTANT TORX® schroeven	1298RTX
SP = voor SPANNER schroeven	861SP
TRW = voor TRI-WING® schroeven	861TRW
TQS = voor TORQ-SET® schroeven	861TQS
TX = voor TORX® schroeven	920TX
XZN = voor XZN® schroeven	920XZN

Meest gebruikte symbolen	Voorbeeld
Algemeen	
AS = inch maatvoering	42AS
BA = vonkvrij gereedschap	42BA
BM = 2 componenten handgreep	1150BM
C = lege metalen kist	C25
HS = gereedschap met valbeveiliging	42HS
INOX = gereedschappen vervaardigd uit roestvast staal	42 INOX
L = lange uitvoering	952L
MQ = 1000V geïsoleerd gereedschap	1150MQ
MP = hoogglanzend verchromd	42MP
R = onderdeel	338R

De afbeeldingen dienen uitsluitend als voorbeeld.

Beta utensili behoudt zich het recht voor de producten te wijzigen en te verbeteren zonder voorafgaand bericht.



Beta Wij adviseren U de gereedschappen op de juiste wijze te gebruiken overeenkomstig met de normen ter bescherming van de gebruiker.



PENDRIJVERS

Beta's slaggereedschap is ontworpen om optimale prestaties te leveren en de veiligheid van de gebruiker te garanderen.

Voor de productie wordt een speciale staalsoort gebruikt die chroom, molybdeen en vanadium (65CrMoV2-2) bevat, wat resulteert in opmerkelijk harde en taai gereedschappen. De producten worden gemaakt - indien dit door hun geometrie is toegestaan - uit getrokken staven; anders worden ze heet gesmeed in een gecontroleerde atmosfeer om slakvorming te voorkomen.

1

De zeshoekige profielen voorkomen dat het gereedschap weg rolt

2

de pendrijvers zijn voorzien van extreem lange maar perfect rechte schachten om toegang tot kleine ruimtes mogelijk te maken.

3

Om er zeker van te zijn dat de pendrijvers de juiste maat hebben, wordt elk stuk met de voorkant gefreesd, zodat een uniform cilindrisch deel en een perfect vlak uiteinde kan worden verkregen, voor een grotere efficiëntie.

4

Alle zijden worden onderworpen aan inductie-ontlaten om versplintering te voorkomen; de vervorming van het slagpunt is een natuurlijk gevolg, zodat de veiligheid van de bediener kan worden gewaarborgd.

5



De centerpunten en doorslagen zijn geslepen nadat ze zijn verchroomd, om betere markeer- en snijprestaties te bieden en om de galvanische aanslag van de punten te verwijderen. Overmatige afzettingen moeten worden verwijderd om "afronding" van de hoeken en broosheid als gevolg van de hoeveelheid waterstof die tijdens het galvaniseren wordt geproduceerd, te voorkomen. De bewerkte delen zijn beschermd met een roestwerende laag.



30

Doorslagen



Ø mm	L mm	€	Hand	Computer
2	125	7,20	10	000300020
3	125	7,20	10	000300030
4	150	9,75	10	000300040
5	150	9,75	10	000300050
6	150	10,30	10	000300060

31

Pendrijvers



Ø mm	L mm	L1 mm	€	Hand	Computer
2	110	22	7,20	10	000310002
3	128	35	7,50	10	000310003
4	146	45	9,30	10	000310004
5	164	55	9,90	10	000310005
6	182	65	12,20	5	000310006
8	200	80	13,10	5	000310008
10	220	95	16,90	5	000310010



Model	€	Hand	Computer
31/B6N 2-3-4-5-6-8 mm	69,50	1	000310024
2002/BV6	10,20	1	020020000
31/SP6 2-3-4-5-6-8 mm	73,00	1	000310030
31/SPV	19,30	1	000310031

31BM

Pendrijvers met handvat



Ø mm	L mm	L1 mm	€	Hand	Computer
2	168	42	14,90	2	000310402
3	180	52	15,40	2	000310403
4	191	62	17,10	2	000310404
5	200	72	18,00	2	000310405
6	221	82	20,70	2	000310406
8	235	94	22,00	2	000310408



Model	€	Hand	Computer
31BM/D6 2-3-4-5-6-8 mm	108,00	1	000310420

31L

Pendrijvers lange uitvoering



Ø mm	L mm	L1 mm	€	Hand	Computer
4	175	80	11,10	5	000310104
5	175	80	11,70	5	000310105
6	175	80	14,00	5	000310106

31SE

Pendrijvers met geleidingspunt

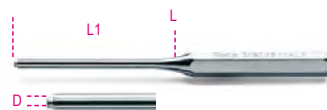

Ø mm	D mm	L mm	L1 mm	€	Hand	Computer
4	2,4	175	80	10,90	5	000310204
5	3,0	175	80	11,50	5	000310205
6	3,6	175	80	13,80	5	000310206



Model	€	Hand	Computer
31/B6N-LSE 31L: 4-5-6 mm 31SE: 4-5-6 mm	83,00	1	000310324
2002/BV6	10,20	1	020020000

32

Centerpunten



Ø mm	L mm	L1 mm	€	Hand	Computer
3	100	44	6,70	10	000320100
4	125	52	8,20	10	000320125
5	150	62	10,50	10	000320150

32AU

Automatische centerpunt

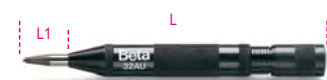

Ø mm	L mm	L1 mm	€	Hand	Computer
3	150	23	56,50	2	000320160

32AUR

Reserve punt voor automatische centerpunt



∅ mm	€	5	000320170
3	10,00		

33IT

Set letter pensen

- Voor het graven van staal met weerstand R tot 80 kg/mm²
- Kit van 27 pensen: letters A tot Z + &

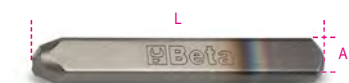

H mm	L mm	A mm	€	1	000330023
3	60	6,35	53,00		
4	63	7,93	62,00		
5	61	7,93	62,00		
6	68	9,52	76,00		
8	70	12,7	114,00		

33NR

Set cijfer pensen

- Voor het graven van staal met weerstand R tot 80 kg/mm²
- Kit van 9 pensen: cijfers 0 tot 9



H mm	L mm	A mm	€	1	000330003
3	61	6,35	22,00		
4	62	7,93	24,00		
5	62	7,93	24,00		
6	68	9,52	29,00		
8	71	12,7	41,00		

34

Koudbeitels



L mm	A mm	L1 mm	€	5	000340001
125	14,5	45	11,00		
150	17,0	58	14,80		
175	21,5	68	21,00		

35

Koudbeitels, geprofileerd model



L mm	A mm	€	5	000350001
100	14,5	12,90		
125	17,0	14,90		
150	20,5	18,60		
200	23,0	28,50		
250	28,5	40,50		
300	34,0	55,50		

35PM

Koudbeitels, geprofileerd model met handbescherming



L mm	A mm	€	2	000350014
200	23,0	43,00		
250	28,5	55,00		
300	34,0	72,00		

35PMR

Handbeschermer



L mm	€	1	000350024
200	14,60		
250	14,60		
300	16,50		

36

Ritsbeitels



L mm	A mm	L1 mm	€	5	000360001
125	4	44	12,20		
150	6	53	14,40		

37

Ritsbeitels, geprofileerd model



L mm	A mm	L1 mm	€	5	000370001
150	6	45	21,10		
200	8	55	30,00		

37PM

Ritsbeitels, geprofileerd model met handbescherming



L mm	A mm	€	2	000370012
200	8	46,50		

37PMR

Handbeschermer



L mm	€	1	000370022
200	16,50		



38/B6N



38/SP6

€	1	000380016
73,00		
38/B6N		
30: 2-3 mm		
32: 4 mm		
34: 125-150 mm		
36: 150 mm		
2002/BV6	10,20	1 020020000
38/SP6	79,00	1 000380009
30: 2-3 mm		
32: 4 mm		
34: 125-150 mm		
36: 150 mm		
38/SPV	20,70	1 000380019



BETA'S ICONISCHE RINGSTEEKSLEUTEL

Onze baanbrekende sleutel 42 heeft een nieuwe vorm.

Een stijlvolle, slanke vorm versterkt door een slank profiel, lichter aanvoelend.

De sterkte, veerkracht en het ergonomische ontwerp van de Beta-sleutel bereiken nog hogere waarden, om gebruikers het best mogelijke gereedschap te bieden.

Het fabricageproces vindt plaats in onze fabrieken in Sovico en Sulmona, op basis van de modernste automatiseringstechnologie en de best opgeleide arbeiders..

SNEL

Een hoek van 15 graden ten opzichte van de as, om de opneemhoek te verkleinen

VEERKRACHTIG

Opmerkelijke sterkte: bij oneigenlijk gebruik slaat de sleutel vast, zonder plotseling en gevaarlijk te breken

HOMOGEEN

Het smeden is gebaseerd op een halffabricaat met ronde doorsnede dat resulteert in homogeen verdeelde vezels, waardoor gevaarlijke interne spanningsvorming wordt voorkomen

TOEGANKELIJK

Verminderde dikte voor verbeterde toegankelijkheid

BESCHERMD

Nikkel-verchromen biedt blijvende weerstand tegen invloeden van buitenaf en voldoet aan de strenge eisen van hechtingstests onder ISO 2819

GEOPTIMALISEERD

De sleutel, die langer is dan die van de meeste concurrenten, maakt hoge koppels mogelijk door minder inspanning



ERGONOMISCH

De offset-ring heeft een hoek van 15 graden om de hand te beschermen. De vorm wordt verkregen uit een matrijs; het wordt later niet gebogen



42

Ringsteeksleutels

Koppelwaarden zijn meer dan verdubbeld in vergelijking met de vereisten waaraan moet worden voldaan onder ISO 1711



DIN 3113 UNI-ISO 7738

mm	L mm	S1 mm	€	5	10
5,5x5,5	95	3,4	7,75	5	000421005
6x6	95	3,4	7,85	5	000421006
7x7	105	3,6	8,00	5	000421007
8x8	116	3,9	8,15	5	000421008
9x9	127	4,2	8,60	5	000421009
10x10	137	4,5	8,80	5	000421010
11x11	148	4,8	9,50	5	000421011
12x12	158	5,1	9,60	5	000421012
13x13	169	5,6	9,70	5	000421013
14x14	180	5,7	11,10	5	000421014
15x15	190	6,0	12,20	5	000421015
16x16	201	6,3	12,60	5	000421016
17x17	212	6,8	13,30	5	000421017
18x18	222	7,0	14,30	5	000421018
19x19	233	7,5	14,60	5	000421019
20x20	243	7,7	16,40	3	000421020
21x21	254	7,9	17,70	3	000421021
22x22	264	8,3	18,30	3	000421022
23x23	275	8,5	19,70	3	000421023
24x24	285	8,7	20,60	3	000421024
25x25	296	8,7	21,90	2	000421025
26x26	307	8,9	23,50	2	000421026
27x27	317	9,1	25,50	2	000421027
28x28	328	9,3	26,00	2	000421028
29x29	338	9,5	29,00	2	000421029
30x30	349	9,7	30,00	2	000421030
32x32	370	10,1	33,00	2	000421032
34x34	391	10,5	65,00	1	000421034
35x35	412	10,7	67,50	1	000421035
36x36	412	10,7	70,00	1	000421036
38x38	433	11,3	78,50	1	000421038
41x41	465	12,0	85,00	1	000421041



	€	5	10
42/B9N 6-7-8-10-11-13-14-17-19 mm	104,00	1	000421074
2002/BV9	13,00	1	020020030



OPGELET!

De vorm van ringsteeksleutel 42 is volledig compatibel met alle gereedschapswagens en modules van de oude versie ringsteeksleutel 42





	€		
42/S14	164,50	1	000421067
6-7-8-10-11-12-13-14 -15-16-17-19-22-24 mm			
42/S17	200,50	1	000421065
6-7-8-9-10-11-12-13-14-15 16-17-18-19-20-21-22 mm			
42/S15	228,00	1	000421066
6-7-8-10-11-12-13-14 17-19-22-24-27-30-32 mm			
42/S17X	237,50	1	000421068
6-7-8-10-11-12-13-14- 15-16-17-19-21-22- 24-27-30 mm			
42/S26	430,00	1	000421070
6-7-8-9-10-11-12-13-14 15-16-17-18-19-20-21 22-23-24-25-26-27-28 29-30-32 mm			

42/SC9I-E

9 delig set ringsteeksleutels in compacte houder

Koppelwaarden zijn meer dan verdubbeld in vergelijking met de vereisten waaraan moet worden voldaan onder ISO 1711



	€		
42/SC9I	105,50	1	000421087
8-10-11-12-13-14-15-17-19 mm			
142/SCV9I	10,30	1	001420103
42/SC9E	109,00	1	000421088
8-10-11-12-13-16-17-18-19 mm			
142/SCV9E	10,30	1	001420104



	€		
42/SP25	453,00	1	000421085
6-7-8-9-10-11-12-13-14 15-16-17-18-19-20-21 22-23-24-25-26-27-28 30-32 mm			
42/SPV2	52,00	1	000420090



42/SP15

42/SPV...

	€		
42/SP15	179,00	1	000421078
6-7-8-9-10-11-12-13-14-15 16-17-19-22-24 mm			
42/SPV7	7,20	1	000420097
42: 8-10-11-13-14-17-19 mm 55: 6x7-8x9-10x11-12x13 14x15-16x17-18x19 mm			
42/SPV11	10,20	1	000420100
42MP: 8-9-10-11-12-13 14-15-16-17-19 mm			
142-142SN: 8-9-10-11-12-13 14-15-16-17-19 mm			
42/SPV15	14,10	1	000420102
42: 6-7-8-9-10-11-12-13-14 15-16-17-19-22-24 mm			

42AS

Ringsteeksleutels



"	L mm	€		
1/4x1/4	95	9,70	2	000420106
9/32x9/32	106	9,90	2	000420107
5/16x5/16	116	10,00	2	000420108
3/8x3/8	137	11,00	2	000420110
7/16x7/16	148	11,70	2	000420111
1/2x1/2	169	12,10	2	000420113
9/16x9/16	180	13,20	2	000420114
19/32x19/32	191	14,50	2	000420115
5/8x5/8	201	15,30	2	000420116
11/16x11/16	212	16,40	2	000420117
3/4x3/4	233	17,40	2	000420119
13/16x13/16	254	21,00	2	000420121
7/8x7/8	264	21,70	2	000420122
15/16x15/16	285	25,50	2	000420124
1x1	296	26,00	2	000420125
1.1/16x1.1/16	317	30,00	2	000420127
1.1/8x1.1/8	338	32,50	2	000420129
1.1/4x1.1/4	370	39,50	2	000420132
1.5/16x1.5/16	391	66,50	1	000420133
1.3/8x1.3/8	412	74,50	1	000420135
1.7/16x1.7/16	412	77,50	1	000420136
1.1/2x1.1/2	433	83,00	1	000420138



	€		
42AS/B9N	130,00	1	000420159
1/4-5/16-3/8-7/16-1/2 9/16-5/8-11/16-3/4			
2002/BV9	13,00	1	020020030



	€		
42AS/13	211,00	1	000420163
1/4-5/16-3/8-7/16-1/2-9/16-5/8 11/16-3/4-13/16-7/8-15/16-1			
42AS/16	313,00	1	000420166
1/4-5/16-3/8-7/16-1/2-9/16-5/8 11/16-3/4-13/16-7/8-15/16-1- 1.1/16-1.1/8-1.1/4			
42AS/17	298,00	1	000420168
1/4-9/32-5/16-3/8-7/16-1/2- 9/16-19/32-5/8-11/16-3/4- 13/16-7/8-15/16-1-1.1/16-1.1/8			

42MP

Ringsteeksleutels hoogglanzend verchromd



DIN 3113 UNI-ISO 7738

"	L mm	€		
6x6	95	14,40	5	000420606
7x7	105	14,70	5	000420607
8x8	116	14,70	5	000420608
9x9	127	15,00	5	000420609
10x10	137	15,10	5	000420610
11x11	148	15,30	5	000420611
12x12	158	15,40	5	000420612
13x13	169	15,70	5	000420613
14x14	180	16,30	5	000420614
15x15	190	17,60	5	000420615
16x16	201	18,60	5	000420616
17x17	212	19,50	5	000420617
18x18	222	20,60	5	000420618
19x19	233	21,40	5	000420619
20x20	243	24,40	3	000420620
21x21	254	25,50	3	000420621
22x22	264	26,00	3	000420622
24x24	285	30,50	3	000420624
27x27	317	36,00	3	000420627
30x30	349	44,50	3	000420630
32x32	370	46,50	3	000420632



	€		
42MP/B9N	160,00	1	000420661
6-7-8-10-11-13-14-17-19 mm			
2002/BV9	13,00	1	020020030



	€		
42MP/S17	310,00	1	000420652
6-7-8-9-10-11-12-13-14-15 16-17-18-19-20-21-22 mm			
42MP/S21	468,00	1	000420653
6-7-8-9-10-11-12-13-14 15-16-17-18-19-20-21-22 24-27-30-32 mm			

42LMP

Ringsteeksleutels, lange uitvoering
hoogglanzend verchromd



Ø mm	L mm	€	Hand	Computer
8x8	148	14,00	2	000420508
9x9	167	14,60	2	000420509
10x10	172	14,60	2	000420510
11x11	186	15,10	2	000420511
12x12	197	15,30	2	000420512
13x13	207	15,70	2	000420513
14x14	223	16,60	2	000420514
15x15	233	18,20	2	000420515
16x16	243	19,60	2	000420516
17x17	261	20,70	2	000420517
18x18	270	22,70	2	000420518
19x19	280	23,20	2	000420519
21x21	301	26,50	2	000420521
22x22	318	27,50	2	000420522
24x24	338	32,50	2	000420524
27x27	376	36,50	2	000420527
30x30	409	46,50	2	000420530
32x32	435	50,50	2	000420532



42LMP/S14	264,00	1	000420551
8-9-10-11-12-13-14 15-16-17-18-19-21-22 mm			
42LMP/S18	430,00	1	000420552
8-9-10-11-12-13-14 15-16-17-18-19-21-22 24-27-30-32 mm			

42SLIM

Ringsteeksleutels met dunne bekken



DIN 3113 UNI-ISO 7738

Ø mm	L mm	S1 mm	€	Hand	Computer
8x8	116	3,4	9,05	5	000420408
10x10	137	3,8	9,80	5	000420410
11x11	148	3,8	10,40	5	000420411
12x12	158	4,2	10,60	5	000420412
13x13	169	4,4	10,70	5	000420413
14x14	180	4,6	12,20	5	000420414
15x15	190	4,7	13,20	5	000420415
16x16	201	4,7	13,70	5	000420416
17x17	212	5,1	14,40	5	000420417
18x18	222	5,1	15,30	5	000420418
19x19	233	5,6	15,60	5	000420419



42SLIM/B8NI	110,00	1	000420478
10-11-12-13-14-15-17-19 mm			
42SLIM/B8NE	113,50	1	000420479
10-11-12-13-16-17-18-19 mm			
2002/BV8	13,00	1	020020020



42SLIM/S11	135,00	1	000420471
8-10-11-12-13-14-15- 16-17-18-19 mm			

45

Ringsteeksleutels, extra zware
uitvoering



DIN 3113 UNI-ISO 7738

Ø mm	L mm	€	Hand	Computer
46x46	500	126,50	1	000450046
50x50	540	155,00	1	000450050
55x55	560	194,00	1	000450055
60x60	600	266,00	1	000450060
65x65	675	456,00	1	000450065
70x70	675	488,00	1	000450070
75x75	720	571,00	1	000450075
80x80	720	608,00	1	000450080

52

Enkele steeksleutels



UNI 6733 DIN 3114

Ø mm	L mm	€	Hand	Computer
10	119	9,80	5	000520010
11	119	10,00	5	000520011
12	119	10,40	5	000520012
13	145	11,50	5	000520013
14	145	11,80	5	000520014
15	145	12,70	5	000520015
16	159	13,30	5	000520016
17	159	13,40	5	000520017
18	159	14,20	5	000520018
19	175	15,50	5	000520019
20	175	16,50	5	000520020
21	175	17,00	5	000520021
22	196	19,00	2	000520022
23	196	19,60	2	000520023
24	196	20,00	2	000520024
25	215	22,50	2	000520025
26	215	22,90	2	000520026
27	215	23,40	2	000520027
28	240	27,00	2	000520028
30	240	27,00	2	000520030
32	270	32,50	2	000520032
34	270	36,00	1	000520034
35	295	41,50	1	000520035
36	295	41,50	1	000520036
38	295	45,50	1	000520038
40	335	57,00	1	000520040
41	335	57,00	1	000520041
42	335	62,50	1	000520042
45	370	73,00	1	000520045
46	370	73,00	1	000520046
48	370	82,00	1	000520048
50	415	96,00	1	000520050
52	415	106,50	1	000520052
55	415	111,00	1	000520055
60	490	140,50	1	000520060
65	490	142,50	1	000520065
70	490	161,50	1	000520070

53

Enkele steeksleutels DIN 894



Ø mm	L mm	€	Hand	Computer
36	317	31,50	1	000530036
38	320	34,50	1	000530038
41	342	39,50	1	000530041
46	396	49,00	1	000530046
50	412	73,50	1	000530050
55	457	85,00	1	000530055
60	492	104,00	1	000530060
65	528	123,00	1	000530065
70	572	142,50	1	000530070
75	608	179,00	1	000530075
80	645	218,50	1	000530080
85	690	268,00	1	000530085
90	690	314,00	1	000530090
95	847	439,00	1	000530095
100	847	463,00	1	000530100
105	1000	582,00	1	000530105
110	1000	627,00	1	000530110
115	1000	701,00	1	000530115
120	1000	791,00	1	000530120
125	1000	916,00	1	000530125
130	1000	981,00	1	000530130
135	1000	1.052,00	1	000530135

55

Dubbele steeksleutels



UNI-ISO 10102 DIN 3110

Ø mm	L mm	€	Hand	Computer
4x5	101	5,80	5	000550003
5x5,5	101	6,60	5	000550006
5,5x7	120	6,50	5	000550009
6x7	120	5,10	5	000550012
7x8	140	6,55	5	000550018
8x9	140	5,30	5	000550021
8x10	140	6,55	5	000550024
10x11	155	5,70	5	000550030
10x12	155	7,60	5	000550033
10x13	170	8,30	5	000550035
12x13	170	6,45	5	000550042
12x14	170	8,50	5	000550045
13x14	185	9,60	5	000550047
13x17	189	10,20	5	000550051
14x15	185	8,05	5	000550054
14x17	189	11,10	5	000550057
16x17	202	9,35	5	000550060
17x19	220	12,20	2	000550063
18x19	220	11,20	2	000550066
19x22	236	14,00	2	000550069
20x22	236	12,90	2	000550075
21x23	245	14,10	2	000550078
22x24	245	15,20	2	000550081
24x26	262	15,80	2	000550087
24x27	262	17,40	2	000550090
25x28	272	17,90	2	000550096
27x29	284	20,00	2	000550099
27x30	284	22,80	2	000550102
27x32	297	25,50	2	000550105
30x32	297	22,80	2	000550108
32x36	325	69,00	1	000550114
34x36	325	69,00	1	000550117
35x38	375	75,50	1	000550120
36x41	375	78,50	1	000550123
41x46	425	89,50	1	000550129
46x50	475	111,50	1	000550132
50x55	500	131,00	1	000550135
55x60	500	129,00	1	000550138



	€	🔧	📦
55/B8N	77,00	1	000550160
6x7-8x9-10x11-12x13 14x15-16x17-18x19 20x22 mm			
2002/BV8	13,00	1	020020020
55/B12N	156,50	1	000550164
6x7-8x9-10x11-12x13 14x15-16x17-18x19 20x22-21x23-24x26 25x28-30x32 mm			
2002/BV12	21,70	1	020020040



	€	🔧	📦
55/S8	64,00	1	000550174
6x7-8x9-10x11-12x13 14x15-16x17-18x19 20x22 mm			
55/S12	134,50	1	000550178
6x7-8x9-10x11-12x13 14x15-16x17-18x19 20x22-21x23-24x26 25x28-30x32 mm			
55/S12X	136,00	1	000550179
6x7-8x9-10x11-12x13 14x15-16x17-18x19 20x22-21x23-24x27 25x28-30x32 mm			
55/S13	154,50	1	000550182
6x7-8x9-10x11-12x13 14x15-16x17-18x19 20x22-21x23-24x26 25x28-27x29-30x32 mm			



55/SP7



55/SP13

	€	🔧	📦
55/SP7	54,00	1	000550167
6x7-8x9-10x11-12x13 14x15-16x17-18x19 mm			
42/SPV7	7,20	1	000420097
42: 8-10-11-13-14-17-19 mm			
55: 6x7-8x9-10x11-12x13			
14x15-16x17-18x19 mm			
55/SP13	192,50	1	000550186
6x7-8x9-10x11-12x13 14x15-16x17-18x19 20x22-21x23-24x26 25x28-27x29-30x32 mm			
55/SPV	38,00	1	000550190

55AS

Dubbele steeksleutels



🔧	L	€	🔧	📦
mm	mm			
1/4x9/32	120	7,05	2	000550203
1/4x5/16	120	7,05	2	000550206
5/16x11/32	140	7,50	2	000550209
5/16x3/8	140	7,60	2	000550212
3/8x7/16	155	8,00	2	000550215
7/16x1/2	170	8,95	2	000550218
1/2x9/16	170	9,50	2	000550221
9/16x5/8	185	10,80	2	000550224
19/32x11/16	189	12,90	2	000550227
5/8x11/16	202	13,20	2	000550230
5/8x3/4	202	14,40	2	000550233
11/16x13/16	220	15,00	2	000550242
3/4x7/8	236	16,50	2	000550245
25/32x13/16	236	16,50	2	000550244
7/8x15/16	245	17,40	2	000550251
15/16x1	262	22,90	1	000550257
1x1.1/8	272	24,30	1	000550259
1.1/16x1.1/4	284	31,50	1	000550267
1.1/8x1.5/16	297	31,50	1	000550266
1.5/16x1.1/2	325	80,00	1	000550269
1.3/8x1.1/2	375	87,00	1	000550272
1.7/16x1.5/8	375	87,00	1	000550275



	€	🔧	📦
55AS/5	54,50	1	000550290
5/16x11/32-3/8x7/16 1/2x9/16-5/8x11/16 3/4x7/8			
55AS/8	87,50	1	000550296
1/4x9/32-5/16x11/32-3/8x7/16- 1/2x9/16-9/16x5/8-5/8x11/16- 11/16x13/16-3/4x7/8			
55AS/12	182,50	1	000550298
1/4x9/32-5/16x11/32-3/8x7/16-1 1/2x9/16-9/16x5/8-5/8x11/16- 11/16x13/16-25/32x13/16-3/4x7/8- 15/16x1-1x1.1/8-1.1/16x1.1/4			

55MP

Dubbele steeksleutels hoogglanzend verchromd



UNI-ISO 10102 DIN 3110

🔧	L	€	🔧	📦
mm	mm			
6x7	120	7,40	2	000550603
8x9	140	8,15	2	000550606
10x11	155	8,60	2	000550609
12x13	170	9,80	2	000550612
14x15	185	11,50	2	000550615
16x17	202	13,50	2	000550618
18x19	220	15,70	2	000550621
20x22	236	17,60	2	000550624
21x23	245	19,70	2	000550627
24x26	262	23,80	1	000550630
25x28	272	25,00	1	000550633
27x29	284	28,00	1	000550636
30x32	297	32,00	1	000550639

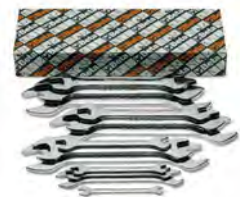

	€	🔧	📦
55MP/S8	92,00	1	000550650
6x7-8x9-10x11-12x13 14x15-16x17-18x19 20x22 mm			
55MP/S13	220,50	1	000550651
6x7-8x9-10x11-12x13 14x15-16x17-18x19 20x22-21x23-24x26 25x28-27x29-30x32 mm			
55MP/S12	192,50	1	000550653
6x7-8x9-10x11-12x13-14x15- 16x17-18x19-20x22-21x23-24x26- 25x28-30x32 mm			

58

Steekslagsleutel



DIN 133

🔧	L	€	🔧	📦
mm	mm			
24	177	34,00	1	000580024
27	180	36,00	1	000580027
30	190	39,50	1	000580030
32	190	40,50	1	000580032
34	200	53,00	1	000580034
36	215	54,50	1	000580036
41	235	63,50	1	000580041
46	255	85,00	1	000580046
50	275	94,00	1	000580050
55	300	112,50	1	000580055
60	320	123,50	1	000580060
65	342	164,50	1	000580065
70	375	214,50	1	000580070
75	375	237,50	1	000580075
80	408	340,00	1	000580080
85	408	385,00	1	000580085
90	445	445,00	1	000580090
95	445	457,00	1	000580095
100	485	619,00	1	000580100
105	485	690,00	1	000580105
110	510	759,00	1	000580110
115	510	867,00	1	000580115
120	545	882,00	1	000580120
125	545	1.002,00	1	000580125
130	575	1.465,00	1	000580130
135	575	1.540,00	1	000580135
*140	575	1.690,00	1	000580140
*145	640	2.180,00	1	000580145
*150	640	2.355,00	1	000580150
*155	640	2.750,00	1	000580155
*160	640	2.880,00	1	000580160
*165	715	3.110,00	1	000580165
*170	715	4.220,00	1	000580170
*175	715	4.430,00	1	000580175
*180	715	4.780,00	1	000580180
*185	715	4.940,00	1	000580185
*190	800	5.440,00	1	000580190
*195	800	5.760,00	1	000580195
*200	800	6.010,00	1	000580200
*210	800	7.380,00	1	000580210
*220	800	9.560,00	1	000580220
*230	800	11.550,00	1	000580230

73

Kleine dubbele steeksleutels



UNI 6737

mm	L mm	€		
4x4	78	8,90	5	000730040
4,5x4,5	78	8,90	5	000730045
5x5	78	8,90	5	000730050
5,5x5,5	86	9,70	5	000730055
6x6	86	9,70	5	000730060
7x7	86	9,70	5	000730070
8x8	97	9,90	5	000730080
9x9	97	9,90	5	000730090
10x10	108	10,90	5	000730100
11x11	108	10,90	5	000730110
12x12	124	12,80	5	000730120
13x13	124	12,80	5	000730130
14x14	124	12,80	5	000730140



	€		
73/B13N 4-4,5-5-5,5-6-7-8-9 10-11-12-13-14 mm	149,00	1	000730202
2002/BV13	13,00	1	020020050



	€		
73/S13 4-4,5-5-5,5-6-7-8-9 10-11-12-13-14 mm	136,00	1	000730210

78

Ringslagsleutel



DIN 7444

mm	L mm	€		
24	162	35,50	1	000780024
27	180	42,00	1	000780027
30	190	50,00	1	000780030
32	190	51,00	1	000780032
34	200	59,00	1	000780034
36	205	63,50	1	000780036
41	225	83,50	1	000780041
46	235	93,00	1	000780046
50	250	113,50	1	000780050
55	265	131,00	1	000780055
60	275	161,00	1	000780060
65	295	193,00	1	000780065
70	325	203,00	1	000780070
75	325	241,50	1	000780075
80	350	373,00	1	000780080
85	350	395,00	1	000780085
90	390	477,00	1	000780090
95	390	560,00	1	000780095
100	420	630,00	1	000780100
105	420	708,00	1	000780105
110	450	764,00	1	000780110
115	450	888,00	1	000780115
120	490	1.188,00	1	000780120
125	480	1.630,00	1	000780125
130	520	1.930,00	1	000780130
135	520	2.065,00	1	000780135
*140	520	2.385,00	1	000780140
*145	580	2.990,00	1	000780145
*150	580	3.040,00	1	000780150
*155	580	3.630,00	1	000780155
*160	650	3.740,00	1	000780160
*165	650	3.960,00	1	000780165
*170	650	4.760,00	1	000780170
*175	650	5.180,00	1	000780175
*180	650	5.580,00	1	000780180
*185	695	5.810,00	1	000780185
*190	695	6.370,00	1	000780190
*195	695	6.430,00	1	000780195
*200	695	6.430,00	1	000780200
*210	740	6.860,00	1	000780210
*215	740	7.740,00	1	000780215
*220	740	8.550,00	1	000780220
*230	740	10.660,00	1	000780230

78AS

Ringslagsleutels



mm	L mm	€		
*1.1/16	180	49,50	1	000780327
*1.1/8	190	49,50	1	000780329
*1.3/16	190	49,50	1	000780330
*1.1/4	197	54,00	1	000780332
*1.5/16	197	55,00	1	000780333
*1.3/8	223	60,50	1	000780335
*1.7/16	223	72,00	1	000780336
*1.1/2	223	74,00	1	000780338
*1.5/8	223	83,50	1	000780341
*1.11/16	225	86,50	1	000780343
*1.13/16	240	99,00	1	000780346
*1.7/8	250	100,00	1	000780348
*2	250	113,00	1	000780350
*2.1/16	250	117,50	1	000780352
*2.3/16	275	123,00	1	000780355
*2.3/8	270	166,50	1	000780360
*2.9/16	302	184,00	1	000780365

mm	L mm	€		
*2.3/4	350	198,00	1	000780370
*2.15/16	350	229,50	1	000780375
*3.1/8	354	379,00	1	000780380

80

Kniegewrichtsleutels



mm	L mm	€		
6x7	170	38,50	3	000800006
8x9	176	39,00	3	000800008
8x10	179	39,00	3	000800009
10x11	182	41,50	3	000800010
12x13	228	47,50	3	000800012
14x15	232	48,00	3	000800014
13x17	231	50,50	3	000800015
16x17	234	50,50	2	000800016
18x19	285	64,00	2	000800018
19x22	287	67,00	2	000800019
20x22	289	67,00	2	000800020
21x23	289	68,50	2	000800021
24x27	405	113,00	2	000800024
30x32	413	119,00	2	000800030

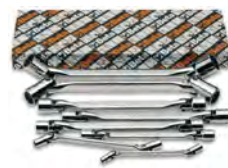

	€		
80/S8 6x7-8x9-10x11-12x13-14x15 16x17-18x19-20x22 mm	396,00	1	000800051
80/S11 6x7-8x9-10x11-12x13 14x15-16x17-18x19-20x22 21x23-24x27-30x32 mm	696,00	1	000800056

83

Startersleutels, speciaal ontwikkeld voor startmotoren



ISO 3318

mm	L mm	€		
8x10	126	19,30	3	000830008
10x12	137	20,30	3	000830010
11x13	138	21,40	3	000830011
14x17	183	27,00	3	000830014
15x17	184	30,50	2	000830015
16x18	196	33,00	2	000830016
19x22	231	42,50	2	000830019



	€		
83/S3 11x13-14x17-19x22 mm	91,00	1	000830081
83/S5 10x12-11x13-15x17 16x18-19x22 mm	147,50	1	000830085

Beta

83AS

Startersleutels, speciaal ontwikkeld voor startmotoren



mm	L mm	€	U	PC
7/16x1/2	138	25,00	2	000830111
9/16x5/8	183	30,00	2	000830114
3/4x7/8	230	47,00	2	000830119



mm	L mm	€	U	PC
83AS/3		102,00	1	000830181
7/16x1/2-9/16x5/8 3/4x7/8				

88

Dubbele platte ringsleutels, extra-lange uitvoering



mm	L mm	€	U	PC
8x10	235	21,90	2	000880008
12x14	330	25,50	2	000880012
13x15	330	25,50	2	000880013
16x18	405	36,00	2	000880016
17x19	405	36,00	2	000880017
21x23	435	41,50	2	000880021
22x24	435	41,50	2	000880022



mm	L mm	€	U	PC
88/S7		228,00	1	000880107
8x10-12x14-13x15-16x18- 17x19-21x23-22x24 mm				

90

Ringsleutels, diep gebogen



DIN 838 ISO 10104

mm	L mm	€	U	PC
6x7	165	10,40	5	000900006
8x9	180	11,50	5	000900012
8x10	180	13,40	5	000900015
10x11	195	12,70	5	000900018
10x12	195	13,70	5	000900021
11x13	215	15,10	5	000900024
12x13	215	13,90	5	000900027
12x14	215	15,70	5	000900030
14x15	230	15,40	5	000900033
14x17	250	19,30	5	000900036
16x17	250	17,50	5	000900039
17x19	265	22,80	5	000900042
18x19	265	20,50	5	000900045
19x22	285	25,50	3	000900048
20x22	285	23,90	3	000900051
21x23	305	26,50	2	000900057
22x24	305	28,00	2	000900060
24x26	325	30,50	2	000900063
24x27	325	33,50	2	000900067
25x28	340	37,00	2	000900070
27x29	355	39,50	2	000900073
27x30	355	43,50	2	000900076
27x32	375	47,50	2	000900078
30x32	375	44,50	2	000900080
32x36	395	64,50	1	000900088
34x36	415	77,00	1	000900089
35x38	415	79,00	1	000900091
36x41	435	88,00	1	000900094
41x46	460	124,50	1	000900097
46x50	500	159,00	1	000900100



mm	L mm	€	U	PC
90/B8N		139,00	1	000900156
6x7-8x9-10x11-12x13 14x15-16x17-18x19 20x22 mm				
2002/BV8		13,00	1	020020020



mm	L mm	€	U	PC
90/S8		126,00	1	000900162
6x7-8x9-10x11-12x13 14x15-16x17-18x19 20x22 mm				
90/S12		264,00	1	000900166
6x7-8x9-10x11-12x13 14x15-16x17-18x19 20x22-21x23-24x26 25x28-30x32 mm				
90/S12X		267,00	1	000900167
6x7-8x9-10x11-12x13 14x15-16x17-18x19 20x22-21x23-24x27 25x28-30x32 mm				
90/S13		304,00	1	000900170
6x7-8x9-10x11-12x13 14x15-16x17-18x19 20x22-21x23-24x26 25x28-27x29-30x32 mm				



mm	L mm	€	U	PC
90/SP13		342,00	1	000900174
6x7-8x9-10x11-12x13 14x15-16x17-18x19 20x22-21x23-24x26 25x28-27x29-30x32 mm				
55/SPV		38,00	1	000550190

90AS

Ringsleutels, diep gebogen



mm	L mm	€	U	PC
1/4x5/16	165	12,80	2	000900203
5/16x11/32	180	13,60	2	000900206
5/16x3/8	180	14,10	2	000900209
3/8x7/16	195	14,40	2	000900212
7/16x1/2	215	16,10	2	000900215
1/2x9/16	230	18,50	2	000900218
9/16x5/8	230	18,50	2	000900221
19/32x11/16	250	20,10	2	000900222
5/8x11/16	250	20,90	2	000900224
5/8x3/4	265	24,80	2	000900227
11/16x3/4	265	24,80	1	000900230
11/16x13/16	265	24,80	1	000900233
3/4x25/32	265	27,50	1	000900235
3/4x7/8	285	27,50	1	000900237
13/16x7/8	285	28,50	1	000900240
7/8x15/16	305	28,50	1	000900243
15/16x1	325	35,00	1	000900252
1.1/16x1.1/4	375	50,50	1	000900258
1.1/8x1.5/16	375	50,50	1	000900261



mm	L mm	€	U	PC
90AS/8		168,50	1	000900298
1/4x5/16-5/16x11/32 3/8x7/16-1/2x9/16 5/8x11/16-11/16x3/4 13/16x7/8-15/16x1				
90AS/10		269,00	1	000900300
1/4x5/16-5/16x11/32 3/8x7/16-1/2x9/16 5/8x11/16-11/16x3/4 13/16x7/8-15/16x1 1.1/16x1.1/4-1.1/8x1.5/16				



91

Opzetrijnsleutels



Ø mm	Ø mm	€		
24	38	60,50	1	000910024
27	41	63,00	1	000910027
30	48	70,00	1	000910030
32	49	74,00	1	000910032
36	54	84,00	1	000910036
41	62	101,50	1	000910041
46	69	117,00	1	000910046
50	76	134,00	1	000910050
55	81	145,00	1	000910055
60	90	185,00	1	000910060
65	98	204,00	1	000910065
70	105	230,50	1	000910070
75	110	269,00	1	000910075
80	125	300,00	1	000910080
85	125	319,00	1	000910085
90	140	557,00	1	000910090
95	140	613,00	1	000910095
100	143	644,00	1	000910100
105	146	736,00	1	000910105

92

Handgreep voor model 91



	L mm	91 mm	Ø mm	€		
92/1	460	24÷30	19	37,50	1	000920010
92/2	610	32÷41	22	59,50	1	000920020
92/3	760	46÷55	25	87,00	1	000920030
92/4	860	60÷105	30	116,50	1	000920040

93

Dubbele ringsleutel
voor verzonken moeren



Ø mm	L mm	€		
21x22	310	49,50	3	000930021

93C

Dubbele dopratelsleutel.



Ø mm	L mm	€		
17x19	310	54,00	1	000930117
19x22	310	57,00	1	000930119
19x24	365	70,50	1	000930120
21x22	310	64,50	1	000930121
36x38	445	107,00	1	000930136

94

Open ringsleutels



DIN 3118

Ø mm	L mm	€		
8x10	140	19,10	2	000940008
9x11	153	20,00	2	000940009
10x11	153	20,70	2	000940010
11x13	175	21,40	2	000940011
12x14	175	22,30	2	000940012
13x15	175	22,30	2	000940013
14x15	175	26,50	2	000940014
14x17	195	27,00	2	000940015
17x19	212	27,50	2	000940017
19x22	228	30,50	2	000940019
22x24	242	36,50	2	000940022
24x27	260	39,50	2	000940024
30x32	300	50,50	2	000940030
36x41	320	88,00	1	000940036



	€		
94/S6	141,50	1	000940050
8x10-10x11-11x13-12x14 17x19-19x22 mm			
94/S10	288,00	1	000940052
8x10-9x11-10x11-11x13 12x14-17x19-19x22 22x24-24x27-30x32 mm			

95

Ringsleutels, plat model



DIN 837 ISO 10103

Ø mm	L mm	€		
6x7	120	12,50	3	000950161
8x9	135	13,50	3	000950162
10x11	150	15,40	3	000950163
12x13	165	16,60	3	000950164
14x15	185	17,90	3	000950165
16x17	210	19,10	3	000950166
17x19	225	21,30	3	000950167
18x19	225	21,80	2	000950168
20x22	240	24,70	2	000950169
21x23	255	25,50	2	000950170
24x26	270	26,50	2	000950171
25x28	285	32,50	2	000950172
27x29	315	33,50	2	000950173
30x32	335	37,50	2	000950174



	€		
95/S8	141,50	1	000950177
6x7-8x9-10x11-12x13 14x15-16x17-18x19 20x22 mm			
95/S13	297,00	1	000950179
6x7-8x9-10x11-12x13 14x15-16x17-18x19 20x22-21x23-24x26 25x28-27x29-30x32 mm			

95FTX

Dubbele platte ringsleutels
voor uitwendige Torx® bouten.



	L mm	€		
E6xE8	115	13,00	2	000950306
E10xE12	143	13,80	2	000950310
E14xE18	177	15,70	2	000950314
E20xE24	224	20,90	2	000950320



	€		
95FTX/S4	63,50	1	000950325
E6xE8-E10xE12 E14xE18-E20xE24			



Beta

HAakse ZESKANT STIFTSLEUTELS

De haakse zeskant stiftsleutels van Beta zijn ontworpen voor langdurig, nauwkeurig gebruik. Het brede assortiment dekt alle gebruiksvereisten: de extra korte, korte, lange, extra lange, kogelkop- en T-sleutels, evenals de sleutels met handgrepen met hoog koppel behoren tot de vlaggenschipproducten van Beta en zijn ongeëvenaard op de markt.

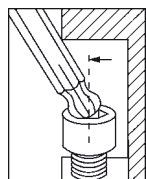

De haakse stiftsleutels met kogelkop maken bediening onder een hoek van maximaal 30° ten opzichte van de schroefas mogelijk.



De sleutels zijn verpakt in een houder voor snelle identificatie van de vereiste maat.

In gesloten toestand voorkomt het dat de sleutels, inclusief de kleinere, per ongeluk naar buiten komen.

De Color-versie combineert de uitstekende eigenschappen van de standaard sleutels met onmiddellijke identificatie van de vereiste maat om het dagelijkse werk te versnellen.

96

Haakse stiftsleutels



ISO 2936

mm	L mm	L1 mm	€		
0,9	35	8	1,09	20	000960013
1,3	39	10	1,09	20	000960014
1,5	45	15	1,09	20	000960015
2	50	17	1,14	20	000960020
2,5	57	20	1,14	20	000960025
3	64	22	1,31	20	000960030
3,5	68	25	1,53	20	000960035
4	72	28	1,65	20	000960040
4,5	78	30	1,77	20	000960045
5	83	32	1,83	20	000960050
5,5	88	35	2,29	20	000960055
6	94	37	2,35	20	000960060
7	99	40	2,86	10	000960070
8	105	43	3,35	10	000960080
9	111	46	3,80	10	000960090
10	119	49	4,60	10	000960100
11	126	52	5,65	10	000960110
12	134	56	6,80	10	000960120
13	142	62	8,80	10	000960130
14	151	69	10,10	10	000960140
16	165	75	15,20	5	000960160
17	174	79	16,10	5	000960170
19	196	88	22,20	5	000960190
22	216	100	34,50	3	000960220
24	242	112	46,50	1	000960240
27	271	125	60,00	1	000960270
30	309	140	83,00	1	000960300
32	341	155	107,00	1	000960312
36	385	174	152,50	1	000960316



96/ST6
2,5-3-4-5-6-8 mm € 15,80 3 000960370



96/BGS7
1,5-2-2,5-3-4-5-6 mm € 33,00 1 000960367



96/BG7
2,5-3-4-5-6-8-10 mm € 35,00 1 000960368



96/B8
2-2,5-3-4-5-6-8-10 mm € 19,60 5 000960386

96/B10
1,5-2-2,5-3-4-5-6-8-10-12 mm € 27,50 5 000960380

96N/BV € 2,25 1 000960651



96/SC9
1,5-2-2,5-3-4-5-6-8-10 mm € 23,50 1 000960374

96/SCV € 5,00 1 000960985



96/SC12
2-2,5-3-3,5-4-4,5-5-6-7-8-9-10 mm € 33,50 1 000960395

96/SCV12 € 6,00 1 000960975

96N

Haakse stiftsleutels gebruneerd



ISO 2936

mm	L mm	L1 mm	€		
0,9	32	10	0,53	20	000960409
1,3	44	12	0,53	20	000960413
1,5	46	15	0,59	20	000960415
2	51	17	0,59	20	000960420
2,5	57	20	0,62	20	000960425
3	64	22	0,70	20	000960430
3,5	68	25	0,82	20	000960435
4	72	28	0,95	20	000960440
4,5	78	30	1,00	20	000960445
5	83	32	1,09	20	000960450
6	94	37	1,40	20	000960460
7	99	40	1,90	10	000960470
8	105	43	2,29	10	000960480
9	111	46	2,86	10	000960490
10	119	49	3,45	10	000960500
11	126	52	4,25	10	000960510
12	134	56	4,95	10	000960520
13	142	62	6,60	10	000960530
14	151	69	7,75	10	000960540
16	165	72	11,30	5	000960560
17	174	79	12,70	5	000960570
19	194	88	17,30	5	000960590
22	216	99	31,50	1	000960592
24	242	111	41,50	1	000960594



96N/ST6
2,5-3-4-5-6-8 mm

€ 11,20 3 000960640



96N/G7
2,5-3-4-5-6-8-10 mm

€ 26,00 3 000960645

96N/G7A
1,5-2-2,5-3-4-5-6 mm

€ 18,50 3 000960643



96N/B10
1,5-2-2,5-3-4-5-6
8-10-12 mm

€ 18,90 5 000960650

96N/BV
€ 2,25 1 000960651



96N/SC9
1,5-2-2,5-3-4-5-6-8-10 mm

€ 16,70 1 000960644

96N/SCV
€ 5,00 1 000960986



96N/SC12
2-2,5-3-3,5-4-4,5-5
6-7-8-9-10 mm

€ 23,70 1 000960661

96N/SCV12
€ 6,00 1 000960976

96C/AS

Zeskant haakse stiftsleutels,
verchroomd



"	L mm	L1 mm	i g	€		
1/16	46	16	1,01	1,95	20	000961702
3/32	53	19	2,70	2,73	20	000961706
1/8	60	22	5,33	2,86	20	000961710
5/32	67	25	9,33	3,40	20	000961714
3/16	74	28	14,87	3,75	20	000961716
7/32	81	32	22,00	4,25	20	000961718
1/4	89	35	31,40	4,80	20	000961720
5/16	103	40	56,16	5,40	10	000961724
3/8	117	45	91,31	6,55	10	000961728



96C-AS/SC9
1/16-3/32-1/8-5/32-3/16-
7/32-1/4-5/16-3/8

€ 40,50 1 000961753

96AS

Haakse stiftsleutels gebruneerd



"	L mm	L1 mm	€		
1/30 (0,035")	44	14	0,95	20	000960698
1/20 (0,050")	44	15	0,95	20	000960701
1/16	46	16	1,08	20	000960702
5/64	50	18	1,29	20	000960704
3/32	53	19	1,46	20	000960706
7/64	57	21	1,52	20	000960708
1/8	60	22	1,52	20	000960710
9/64	64	24	1,83	20	000960712
5/32	68	25	1,88	20	000960714
3/16	75	29	2,10	20	000960716
7/32	82	32	2,42	20	000960718
1/4	89	35	2,78	20	000960720
5/16	103	40	3,45	10	000960724
3/8	117	44	4,35	10	000960728
7/16	132	49	6,05	10	000960730
1/2	149	54	7,75	10	000960732
9/16	151	69	12,90	2	000960734



96AS/SC9
1/16-3/32-1/8-5/32-3/16
7/32-1/4-5/16-3/8

€ 26,00 1 000960743

96AS/SCV
€ 5,00 1 000960744



96AS/T7
3/32-1/8-5/32
3/16-7/32-1/4-5/16

€ 20,80 3 000960740



96AS/BG7
3/32-1/8-5/32-3/16
1/4-5/16-3/8

€ 35,00 1 000960747



96AS/B11
1/20-1/16-5/64-3/32
1/8-5/32-3/16-7/32
1/4-5/16-3/8

€ 25,50 1 000960749

96N/BV
€ 2,25 1 000960651



96LC

Haakse stiftsleutels,
lange uitvoering verchroomd



ISO 2936

mm	L mm	L1 mm	€		
2	101	17	2,02	20	000960320
2,5	113	20	2,16	20	000960321
3	127	22	2,35	20	000960322
3,5	138	25	2,48	20	000960323
4	142	28	2,67	20	000960324
4,5	154	28	3,20	20	000960325
5	163	32	3,45	20	000960326
6	184	37	3,70	20	000960327
7	194	40	4,25	10	000960328
8	205	43	5,20	10	000960329
9	216	46	5,80	10	000960330
10	231	49	7,70	10	000960331
12	259	56	9,95	10	000960332





96LC/SC8 2-2,5-3-4-5-6-8-10 mm	€ 34,00	1	000960334
96LC/SCV	5,00	1	000960983



96LC/SC12 2-2,5-3-3,5-4-4,5-5-6-7-8-9-10 mm	€ 51,00	1	000960337
96LC/SCV12	6,00	1	000960977

96L

Haakse stiftsleutels, lange uitvoering gebruneerd



ISO 2936

mm	L mm	L1 mm	€		
2	99	15	1,46	20	000960820
2,5	110	17	1,52	20	000960825
3	124	19	1,71	20	000960830
3,5	135	21	1,77	20	000960835
4	138	24	2,11	20	000960840
4,5	150	25	2,42	20	000960845
5	158	27	2,54	20	000960850
6	178	31	2,86	20	000960860
7	187	33	3,65	10	000960870
8	197	35	4,55	10	000960880
9	207	37	5,15	10	000960890
10	221	39	6,80	10	000960900
12	247	44	9,00	10	000960920



96L/SC8 2-2,5-3-4-5-6-8-10 mm	€ 28,50	1	000960924
96L/SCV	5,00	1	000960987



96L/SC12 2-2,5-3-3,5-4-4,5-5-6-7-8-9-10 mm	€ 42,50	1	000960929
96L/SCV12	6,00	1	000960978

96BP-CL

Haakse zeskant stiftsleutels met kogelkop, verchroomd, gekleurd



mm	L mm	L1 mm	€		
1,5	91	16	3,15	5	000961600
2	102	17	3,50	5	000961601
2,5	113	21	3,85	5	000961602
3	128	23	4,30	5	000961603
4	143	28	4,75	5	000961604
5	163	33	5,20	5	000961605
6	185	37	6,60	5	000961606
8	206	43	9,00	2	000961608
10	231	50	11,90	2	000961610



96BP-CL/SC9 1,5-2-2,5-3-4-5-6-8-10 mm	€ 57,00	1	000961619
96BP-CL/SCV	4,85	1	000961629

96BPC

Haakse stiftsleutels met kogelkop verchroomd

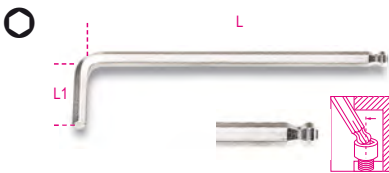

mm	L mm	L1 mm	€		
1,5	79	13	2,49	10	000960340
2	84	15	2,52	10	000960341
2,5	89	17	2,73	10	000960342
3	99	19	2,84	10	000960343
4	108	24	3,35	10	000960344
5	126	27	4,00	10	000960345
6	148	31	5,65	10	000960346
7	157	33	7,50	5	000960353
8	168	35	7,85	5	000960347
10	187	39	12,50	5	000960348
12	220	55	15,70	5	000960352



96BPC/SC9 1,5-2-2,5-3-4-5-6-8-10 mm	€ 49,00	1	000960354
96BPC/SCV	5,00	1	000960984

96BP

Haakse stiftsleutels met kogelkop gebruneerd

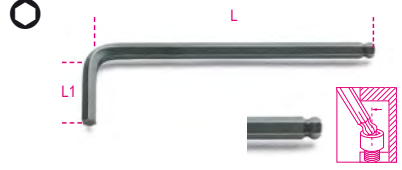

mm	L mm	L1 mm	€		
1,5	79	13	1,80	10	000960960
2	84	15	1,91	10	000960961
2,5	89	17	2,02	10	000960962
3	99	19	2,10	10	000960963
4	108	24	2,54	10	000960965
5	126	27	3,25	10	000960967
6	148	31	4,65	10	000960968
8	168	35	6,75	5	000960970
10	187	39	11,20	5	000960972
12	220	55	16,20	5	000960973



96BP/SC9 1,5-2-2,5-3-4-5-6-8-10 mm	€ 41,00	1	000960974
96BP/SCV	5,00	1	000960988

96LBP

Haakse zeskant stiftsleutel met kogelkop, extra-lang model

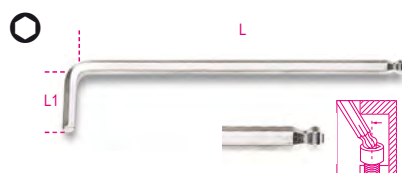

mm	L mm	L1 mm	€		
1,5	90	15	2,67	5	000961340
2	100	17	2,80	5	000961341
2,5	112	20	3,05	5	000961342
3	127	22	3,20	5	000961343
4	144	27	3,90	5	000961344
5	163	32	4,65	5	000961345
6	184	37	6,50	5	000961346
8	204	44	8,95	2	000961348
10	230	49	14,60	2	000961350



96LBP/SC9 1,5-2-2,5-3-4-5-6-8-10 mm	€ 55,50	1	000961354
96LBP/SCV	5,00	1	000961984

96BP/AS

Haakse stiftsleutels met kogelkop gebruneerd

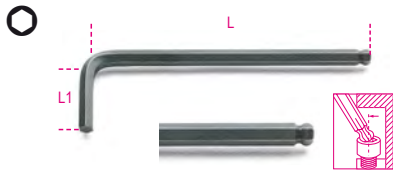

"	L mm	L1 mm	€		
3/32	89	17	2,35	10	000960989
1/8	98	18	2,53	10	000960990
5/32	108	24	3,05	10	000960991
3/16	126	26	3,50	10	000960992
7/32	139	28	4,85	10	000960993
1/4	152	31	5,40	10	000960994
5/16	168	34	7,10	5	000960995
3/8	190	39	11,60	5	000960996



96BP-AS/SC9	46,50	1	000961000
1/16-3/32-1/8-5/32-3/16			
7/32-1/4-5/16-3/8			
96BP-AS/SCV	5,00	1	000961001



96BP-AS/8	42,50	1	000960997
3/32-1/8-5/32-3/16-7/32			
1/4-5/16-3/8			
96BP-AS/BV	2,25	1	000960998

96BPA

Haakse zeskant stiftsleutels met kogelkop, 110°, extra-korte uitvoering aan een zijde



mm	L mm	L1 mm	€		
1,5	71	9	2,68	5	000961960
2	86	11	2,78	5	000961961
2,5	96	13	2,91	5	000961962
3	104	15	3,35	5	000961963
4	116	17	3,80	5	000961964
5	132	19	4,50	5	000961965
6	155	21	6,40	5	000961966
8	176	24	8,90	2	000961968
10	200	27	13,60	2	000961970



96BPA/SC9	54,00	1	000961974
1,5-2-2,5-3-4-5-6-8-10 mm			
96BPA/SCV	5,00	1	000961988

96T

HAAKSE ZESKANT STIFTSLEUTEL

met krachthandgreep

Snel en gemakkelijk te hanteren

De kleine handgreep is perfect uitgebalanceerd om snel in de handpalm te draaien.

Door de ergonomische vorm kunnen extreem hoge draaimomenten worden toegepast.

De zeskantige uiteinden zijn ontworpen om het maximaal mogelijke koppel op de schroef over te brengen.

De ronde stift heeft een homogeen frame ten opzichte van het zeskant uiteinde en zorgt voor extra stevigheid.



Stift loopt door in de handgreep

96T

Haakse stiftsleutels met kracht handgreep

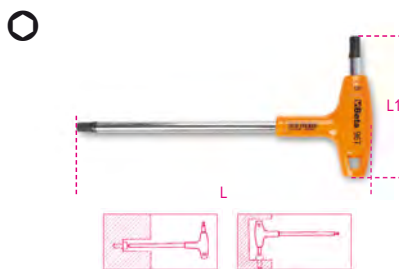

mm	L mm	L1 mm	€		
2	139	52	11,80	5	000960934
2,5	153	55	11,80	5	000960935
3	153	55	12,40	5	000960936
3,5	179	70	12,70	5	000960937
4	179	70	12,70	5	000960938
4,5	200	84	13,20	5	000960939
5	200	84	13,20	5	000960940
6	221	103	14,90	5	000960941
7	236	106	16,60	3	000960942
8	255	117	18,90	3	000960943
10	285	132	22,30	3	000960945



96T/S5P	65,00	1	000960946
2,5-3-4-5-6			
96T/S6	77,00	1	000960952
2-2,5-3-4-5-6 mm			
96T/S8	118,00	1	000960933
2-2,5-3-4-5-6-8-10 mm			
96T/S11	160,50	1	000960951
2-2,5-3-3,5-4-4,5-5-6-7-8-10 mm			



96T/SP11	194,50	1	000960957
2-2,5-3-3,5-4-4,5-5-6-7-8-10 mm			
96T/SPV	35,00	1	000960958
96T/S11			
97TTX/S11			

96T/AS

Haakse stiftsleutel met kracht handgreep

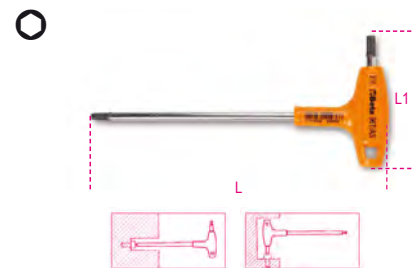

"	L mm	L1 mm	€		
3/32	153	55	14,20	2	000960669
7/64	153	55	14,20	2	000960670
1/8	179	70	14,40	2	000960671
9/64	179	70	15,40	2	000960672
5/32	200	84	15,40	2	000960673
3/16	200	84	15,40	2	000960674
7/32	221	103	17,40	2	000960675
1/4	236	106	19,80	2	000960676
5/16	255	117	21,80	2	000960678
3/8	285	132	27,00	2	000960680



96T/AS8	142,00	1	000960682
3/32-7/64-1/8-5/32-3/16-1/4-5/16-3/8			
96T/AS10	175,00	1	000960683
3/32-7/64-1/8-9/64-5/32-3/16-7/32-1/4-5/16-3/8			

96TBP

Zeskant stiftsleutels met kogelkop en kunststof handgreep



mm	L mm	L1 mm	€	🔧	📄
2,5	153	55	12,10	3	000960685
3	153	55	12,60	3	000960686
4	179	70	13,70	3	000960687
5	200	84	14,10	3	000960688
6	221	103	15,40	3	000960689
8	255	117	20,10	2	000960690
10	285	132	22,10	2	000960692



96TBP/S6
2,5-3-4-5-6-8 mm

€ 88,00 1 000960694

97TX

Haakse stiftsleutels voor Torx® schroeven



mm	L mm	L1 mm	€	🔧	📄
T6	42	16	6,95	5	000970006
T7	48	16	6,95	5	000970007
T8	48	16	6,95	5	000970008
T9	48	16	7,85	5	000970009
T10	51	17	8,15	5	000970010
T15	54	18	8,15	5	000970015
T20	57	19	8,55	5	000970020
T25	60	20	8,90	5	000970025
T27	64	21	9,45	5	000970027
T30	70	24	9,45	5	000970030
T40	76	26	10,90	5	000970040
T45	83	29	13,20	5	000970045
T50	95	32	14,80	5	000970050
T55	108	35	18,50	5	000970055
T60	120	38	24,40	5	000970060



97TX/ST8
T9-T10-T15-T20-T25
T27-T30-T40

€ 77,50 1 000970640



97TX/G8
T9-T10-T15-T20-T25
T27-T30-T40

€ 55,00 1 000970645



97TX/BG8
T9-T10-T15-T20-T25-T27-T30-T40

€ 43,00 1 000970368



97TX/SC8
T9-T10-T15-T20-T25
T27-T30-T40

€ 76,50 1 000970064

97TX/SCV 5,00 1 000970985



97TX/B13
T6-T7-T8-T9-T10-T15-T20
T25-T27-T30-T40-T45-T50

€ 122,50 1 000970650

96N/BV 2,25 1 000960651

97BTX

Haakse stiftsleutels met kogelkop en voor Torx(R) schroeven

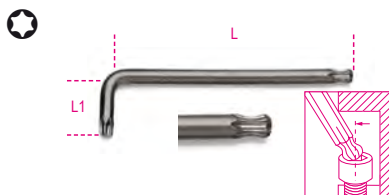

mm	L mm	L1 mm	€	🔧	📄
T9	62	16	9,55	5	000970109
T10	71	17	9,55	5	000970110
T15	81	18	9,55	5	000970115
T20	92	19	10,40	5	000970120
T25	94	20	11,10	5	000970125
T27	105	21	11,80	5	000970127
T30	114	24	12,00	5	000970130
T40	129	26	13,50	5	000970140
T45	133	28	16,20	5	000970145



97BTX/SC8
T9-T10-T15-T20-T25-T27-T30-T40

€ 92,50 1 000970164

97BTX/SCV 5,00 1 000970983



97BTX/B8
T9-T10-T15-T20-T25
T27-T30-T40

€ 89,50 1 000970159

96N/BV 2,25 1 000960651

97BTX-C

Haakse stiftsleutels met kogelkop, voor Torx® profiel schroeven, gekleurd



mm	L mm	L1 mm	€	🔧	📄
T9	80	16	9,70	5	000971609
T10	86	17	9,70	5	000971610
T15	90	18	9,70	5	000971615
T20	95	19	10,60	5	000971620
T25	100	20	11,40	5	000971625
T27	105	21	11,90	5	000971627
T30	114	24	12,30	5	000971630
T40	124	26	13,40	5	000971640



97BTX-C/SC8
T9-T10-T15-T20-T25-T27-T30-T40

€ 93,50 1 000971658

97BTX-C/SCV 5,00 1 000971659



97BTXL

Haakse stiftsleutels met kogelkop, lang model, voor Torx® schroeven



	L mm	L1 mm	€		
T9	80	15	10,10	3	000970309
T10	86	17	10,10	3	000970310
T15	100	18	10,10	3	000970315
T20	110	19	11,20	3	000970320
T25	126	20	13,00	3	000970325
T27	140	24	14,30	3	000970327
T30	160	28	14,90	3	000970330
T40	176	32	17,50	3	000970340



97BTXL/SC8 T9-T10-T15-T20- T25-T27-T30-T40	€ 106,00	1	000970364
97BTXL/SCV	€ 5,00	1	000970982

97RTX

Haakse stiftsleutels met Tamper Resistant Torx® profiel



	L mm	L1 mm	€		
T6	40	15	8,90	5	000970206
T7	45	15	8,90	5	000970207
T8	50	16	8,90	5	000970208
T9	56	16	8,90	5	000970209
T10	62	17	8,90	5	000970210
T15	72	17	9,00	5	000970215
T20	83	18	9,20	5	000970220
T25	90	18	9,35	5	000970225
T27	100	20	10,70	5	000970227
T30	105	24	10,60	5	000970230
T40	112	26	11,70	5	000970240
T45	118	26	13,00	5	000970245
T50	122	28	16,80	3	000970250
T55	128	30	19,40	3	000970255



97RTX/SC8 T9-T10-T15-T20-T25 T27-T30-T40	€ 83,50	1	000970263
97RTX/SCV	€ 5,00	1	000970984



97RTX/B8 T9-T10-T15-T20-T25 T27-T30-T40	€ 80,50	1	000970260
96N/BV	€ 2,25	1	000960651

97BRTXL/SC8

8-delige set haakse stiftsleutels, lang model, met Tamper Resistant Torx® profiel



97BRTXL/SC8 T9-T10-T15-T20- T25-T27-T30-T40	€ 105,00	1	000970464
97BRTXL/SCV	€ 5,00	1	000970986

97TTX

Haakse stiftsleutels voor Torx® schroeven en krachthandgreep

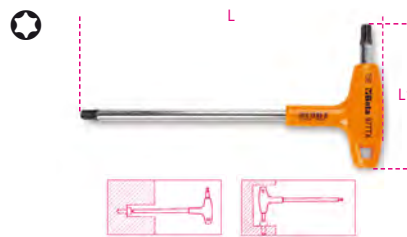

	L mm	L1 mm	€		
T6	130	52	11,90	3	000970706
T7	130	52	11,90	3	000970707
T8	139	52	12,00	3	000970708
T9	139	52	12,40	3	000970709
T10	179	70	12,50	3	000970710
T15	179	70	13,30	3	000970715
T20	179	70	13,70	3	000970720
T25	179	70	14,40	3	000970725
T27	200	84	15,40	3	000970727
T30	200	84	16,30	3	000970730
T40	221	103	19,50	3	000970740
T45	236	106	22,50	2	000970745
T50	255	117	28,50	2	000970750



97TTX/S6 T10-T15-T20-T25-T30-T40	€ 89,50	1	000970791
97TTX/S8 T8-T10-T15-T20-T25- T27-T30-T40	€ 117,00	1	000970808
97TTX/S11 T8-T9-T10-T15-T20-T25 T27-T30-T40-T45-T50	€ 180,50	1	000970800
97TTX/S13 T6-T7-T8-T9-T10-T15-T20-T25 T27-T30-T40-T45-T50	€ 204,50	1	000970813



97TTX/SP11 T8-T9-T10-T15-T20-T25 T27-T30-T40-T45-T50	€ 214,50	1	000970840
96T/SPV 96T/S11 97TTX/S11	€ 35,00	1	000960958

98XZN

Haakse stiftsleutels met XZN® profiel



DIN 65253

	L mm	L1 mm	€		
M5	83	25	6,05	5	000980005
M6	89	30	7,05	5	000980006
M8	97	32	9,10	5	000980008
M10	106	35	11,90	5	000980010
M12	116	37	14,60	5	000980012



98XZN/B5 M5-M6-M8-M10-M12	€ 51,00	1	000980650
96N/BV	€ 2,25	1	000960651

99

Haaksleutels met haak voor moeren UNI/ISO 2982, 2983



UNI 6752

	A mm	€		
12-14	1,5	11,80	3	000990012
16-18-20	1,8	11,80	3	000990016
22-25-28	1,8	15,70	3	000990022
30-32	2,1	15,70	3	000990030
34-36-38	2,4	18,80	3	000990034
40-42	2,4	18,80	3	000990040
45-50	2,5	23,50	3	000990045
52-55-58	2,5	23,50	3	000990052
62-65	3,1	30,00	3	000990062
68-70-75	3,1	30,00	3	000990068
80-85-90	3,8	41,00	2	000990080
92-95	4,3	41,00	2	000990092
98-100	4,3	41,00	2	000990098
105-110-115	4,4	63,00	1	000990105
120-125-130	4,9	63,00	1	000990120
135-145	6,0	90,00	1	000990135
155-165	6,0	90,00	1	000990155

99SQ

Haaksleutels met scharnierende haak



Ø mm	B mm	€	🔧	📄
15-35	2,7	32,00	2	000990215
35-50	3,5	36,00	2	000990235
50-80	4,7	48,50	2	000990250
80-120	6,2	67,50	2	000990280
120-180	7,8	89,50	2	000990290

99ST

Haaksleutels met scharnierende haak en pen



Ø mm	Ø mm	B mm	€	🔧	📄
15-35	3,0	2,5	34,00	2	000990315
35-50	4,0	4,5	38,50	2	000990335
50-80	5,0	5,0	51,50	2	000990350
80-120	6,0	7,0	70,00	2	000990380
120-180	8,0	9,0	92,00	2	000990390

99 VN/...

Reserve pen voor artikel 99ST

	Ø mm	€	🔧	📄
99ST VN/15	15-35	9,10	1	000990295
99ST VN/35	35-50	10,50	1	000990296
99ST VN/50	50-80	12,70	1	000990297
99ST VN/80	80-120	15,20	1	000990298
99ST VN/120	120-180	20,10	1	000990299

100

Pengatsleutels



Ø mm	L mm	Ø min-max mm	€	🔧	📄
4,8-5,8 6,9-7,9	250	18÷100	169,00	1	001000001

100/KIT

Reserve pennen voor model 100



	€	🔧	📄
100/KIT	45,00	1	001000010

111E VERSTELBARE MOERSLEUTEL MET SCHAALVERDELING

Met de nieuwe verstelbare moersleutels met schaal, Beta 111E kunnen bouten en moeren van verschillende grootte worden vastgedraaid en losgemaakt via de verstelbare bekken die je kunt instellen via de centrale rollen.

Kop 15° gebogen, waardoor moeilijk bereikbare plaatsen kunnen worden bereikt, zoals het geval is bij onze iconische ringsteeksleutels, "42"



Brede sleutelopening

Compacte kop met volledig open bekken

Dubbele lasermarkering in mm/inch

Op basis van de nieuwe ergonomische eigenschappen is het gewicht met 20% verminderd. Gemaakt van hoogwaardig gelegeerd staal voor verhoogde mechanische torsiesterkte. Speciale warmtebehandeling voor uitstekende slijtvastheid. Gat in handvat voor het ophangen van de sleutel.

111E

Verstelbare moersleutels met schaalverdeling, verchroomd

- Rechts draaiend van de pen
- Mm/inch-schaal



DIN 3117 ISO 6787

L mm	L "	A max mm	€	🔧	📄
100	4	15	27,00	3	001110110
150	6	24	29,00	3	001110115
200	8	29	35,00	3	001110120
250	10	34	42,00	3	001110125
300	12	40	56,00	3	001110130
380	15	45	109,50	3	001110138
450	18	54	182,50	2	001110145
600	24	62	252,00	1	001110160

111EN

verstelbare moersleutels met schaalverdeling, gefosfateerd

- Linksom draaien van pin
- Mm/inch-schaal



DIN 3117 ISO 6787

L mm	L "	A max mm	€	🔧	📄
100	4	15	25,00	3	001110410
150	6	24	27,00	3	001110415
200	8	29	31,00	3	001110420
250	10	34	38,00	3	001110425
300	12	40	51,00	3	001110430
380	15	45	101,00	3	001110438
450	18	54	172,00	2	001110445

111ER

Omkeerbare steeksleutels met schaalverdeling, verchroomd

- Omkeerbare haak
- Rechts draaien van pen
- Mm/inch-schaal



L mm	L "	A max mm	Ø max mm	€	🔧	📄
200	8	29	3/4	36,50	3	001110520
250	10	34	1	45,00	3	001110525
300	12	40	1.1/4	58,50	2	001110530

111CM

Verstelbare moersleutel met extra brede opening, verchroomd, korte uitvoering

- Brede opening
- Rechtsom draaien
- Mm/inch-schaal



L mm	L "	A max mm	€	🔧	📄
170	6	32	41,50	2	001110770
220	8	38	50,50	3	001110722
270	10	46	66,50	3	001110727

120

Open ringratelsleutels

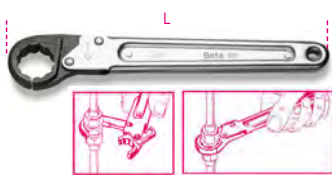

Ø mm	L mm	€	Hand	Computer
10	135	53,00	1	001200010
11	135	53,00	1	001200011
12	135	53,00	1	001200012
13	135	53,00	1	001200013
14	135	59,00	1	001200014
17	185	65,00	1	001200017
19	185	69,50	1	001200019
22	230	95,50	1	001200022
24	230	105,00	1	001200024
27	230	129,50	1	001200027
30	320	150,00	1	001200030
32	320	159,50	1	001200032



Code	€	Hand	Computer
120/B6N 10-11-13 17-19-22 mm	402,00	1	001200060
2002/BVL6	13,00	1	020020010

123E1/4

Bithouder, 1/4" passend in ringratelsleutel 10 mm



Ø mm	L mm	€	Hand	Computer
10	20,6	7,05	1	001230010

123Q1/4

Dophouder 1/4" passend in ringratelsleutel 10 mm



Ø mm	L mm	€	Hand	Computer
10	17,5	9,50	1	001230310

123Q3/8

Dophouder 3/8" passend in ringratelsleutel 13 mm



Ø mm	L mm	€	Hand	Computer
13	22,5	9,65	1	001230313

123Q1/2

Dophouder 1/2" passend in ringratelsleutel 19 mm



Ø mm	L mm	€	Hand	Computer
19	30,5	10,30	1	001230319

123/K4

4 delig set adapters voor ringratelsleutels:
1 bit adapter
3 dopsleutelhouders met vergrendelingsdop



Code	€	Hand	Computer
123/K4	36,50	1	001230504

141

Ratel ringsteeksleutels, platte uitvoering



ISO 21982:2020

Ø mm	L mm	€	Hand	Computer
8x8	136	17,30	3	001410008
9x9	143	18,40	3	001410009
10x10	160	18,90	3	001410010
11x11	168	19,40	3	001410011
12x12	174	19,90	3	001410012
13x13	180	21,70	3	001410013
14x14	193	22,60	2	001410014
15x15	200	23,50	2	001410015
16x16	216	26,00	2	001410016
17x17	233	26,50	2	001410017
18x18	239	29,50	2	001410018
19x19	250	30,00	2	001410019



Code	€	Hand	Computer
141/B6 8-10-13-14-17-19 mm	147,00	1	001410066
141/B9 8-10-11-12-13-14-15-17-19 mm	211,50	1	001410069



Code	€	Hand	Computer
141/S12 8-9-10-11-12-13-14-15-16-17-18-19 mm	274,00	1	001410072

142

RATELRINGSTEEKSLEUTELS

De snelle ratel met 72 tanden biedt een opneemhoek van niet meer dan 5°, wat resulteert in een snelle, nauwkeurige aanhalen.

1 De vaste bek maakt een sterke aanhaling mogelijk, gebaseerd op de lengte van de greep.

2 De ingebouwde omschakelhendel voorkomt elk risico van onbedoeld omkeren.



3 Het twaalfkant ringuiteinde heeft een hoek van 15° om de hand te beschermen en gemakkelijker toegang te bieden.

4 De vaste kop staat onder een hoek van 15° ten opzichte van de as, wat resulteert in een verminderde terugstelhoek.



142

Omschakelbare ratelringsteeksleutels



ISO 21982:2020

Ø mm	L mm	€	Hand	Computer
6x6	136	20,00	3	001420006
7x7	136	20,00	3	001420007
8x8	136	20,30	3	001420008
9x9	143	21,50	3	001420009
10x10	159	22,20	3	001420010
11x11	168	22,90	3	001420011
12x12	174	23,70	3	001420012
13x13	180	25,50	3	001420013
14x14	190	26,50	2	001420014
15x15	200	28,00	2	001420015
16x16	216	29,50	2	001420016
17x17	233	31,50	2	001420017
18x18	239	33,00	2	001420018
19x19	248	34,00	2	001420019
21x21	285	44,50	1	001420021
22x22	285	46,00	1	001420022
24x24	325	53,50	1	001420024
27x27	355	74,50	1	001420027
30x30	420	89,50	1	001420030
32x32	420	92,50	1	001420032
34x34	482	125,00	1	001420034
36x36	482	127,50	1	001420036
38x38	482	130,50	1	001420038



142/B6	€ 170,00	1	001420066
8-10-13-14-17-19 mm			
142/BV6	€ 10,00	1	001420076
142/B9	€ 246,50	1	001420069
8-10-11-12-13-14-15-17-19 mm			
142/BV9	€ 11,90	1	001420079



142/S15	€ 405,00	1	001420074
6-7-8-9-10-11-12-13 14-15-16-17-18-19-22 mm			
142/S17	€ 556,00	1	001420068
6-7-8-10-11-12-13-14-15- 16-17-18-19-21-22-24-27 mm			
142/S19	€ 715,00	1	001420075
6-7-8-9-10-11-12 13-14-15-16-17-18 19-22-24-27-30-32 mm			

142/SC9I-E

9-delig set ratelringsteeksleutels, in compacte houder



142/SC9I	€ 243,00	1	001420087
8-10-11-12-13-14-15-17-19 mm			
142/SCV9I	€ 10,30	1	001420103
142/SC9E	€ 251,00	1	001420088
8-10-11-12-13-16-17-18-19 mm			
142/SCV9E	€ 10,30	1	001420104

142MC

Omschakelbare ratelringsteeksleutels, gekleurd



ISO 21982:2020

mm	L mm	€		
8x8	136	21,50	3	001422008
10x10	159	23,30	3	001422010
11x11	168	24,00	3	001422011
12x12	174	24,90	3	001422012
13x13	180	26,50	3	001422013
14x14	190	27,50	2	001422014
15x15	200	29,50	2	001422015
16x16	216	31,50	2	001422016
17x17	233	33,00	2	001422017
18x18	239	35,00	2	001422018
19x19	248	36,00	2	001422019



142MC/SC9I	€ 255,00	1	001422087
8-10-11-12-13-14-15-17-19 mm			
142MC/SC9E	€ 264,00	1	001422088
8-10-11-12-13-16-17-18-19 mm			

142AS

Omschakelbare ratelringsteeksleutel



mm	L mm	€		
5/16x5/16	136	23,80	2	001420308
3/8x3/8	159	24,40	2	001420310
7/16x7/16	168	26,50	2	001420311
1/2x1/2	180	28,50	2	001420313
9/16x9/16	190	30,00	2	001420314
5/8x5/8	216	33,00	2	001420316
11/16x11/16	233	34,00	2	001420317
3/4x3/4	248	38,00	2	001420319



142AS/8	€ 238,00	1	001420330
5/16-3/8-7/16-1/2 9/16-5/8-11/16-3/4			

142C

Omschakelbare ratelringsteeksleutels, recht kort model



ISO 21982:2020

mm	L mm	€		
8x8	88	14,60	2	001420108
9x9	96	14,60	2	001420109
10x10	96	15,00	2	001420110
11x11	100	15,70	2	001420111
12x12	104	16,90	2	001420112
13x13	108	17,70	2	001420113
14x14	114	18,50	2	001420114
15x15	118	19,10	2	001420115
16x16	122	20,00	2	001420116
17x17	128	21,50	2	001420117
18x18	132	23,10	2	001420118
19x19	138	23,80	2	001420119



142C/A12	€ 249,00	1	001420175
8-9-10-11-12-13-14 15-16-17-18-19 mm			

142SN

Omschakelbare ratelringsteeksleutel met kniegewricht



ISO 21982:2020

mm	L mm	€		
7x7	136	24,30	2	001420207
8x8	136	24,60	2	001420208
9x9	143	26,00	2	001420209
10x10	160	27,50	2	001420210
11x11	168	27,00	2	001420211
12x12	174	28,00	2	001420212
13x13	180	31,50	2	001420213
14x14	193	32,50	2	001420214
15x15	200	35,00	2	001420215
16x16	216	36,00	2	001420216
17x17	233	37,00	2	001420217
18x18	239	39,50	2	001420218
19x19	250	39,50	2	001420219
22x22	285	48,00	1	001420222
24x24	325	56,00	1	001420224



142SN/S13	€ 408,00	1	001420263
7-8-9-10-11-12-13-14 15-16-17-18-19 mm			



142SN/SC9	€ 291,00	1	001420259
8-10-11-12-13-14-15-17-19 mm			

186

Zelfklemmende sleutel met automatische positionering voor zeskant moeren, 8 tot 32 mm

Ideaal voor moeren met zeskant, Spline, vierkant en Torx® aansluiting, alsmede beschadigde moeren.



L mm	€	Stuks	Art. No.
260	57,00	1	001860008

187

Te openen knik-ringsleutels



mm	L mm	€	Stuks	Art. No.
8x9	125	36,00	1	001870008
10x11	155	39,50	1	001870010
12x13	175	41,00	1	001870012
14x15	205	44,00	1	001870014
16x17	235	50,00	1	001870016



Art. No.	€	Stuks	Art. No.
187/B5	222,00	1	001870050

8x9-10x11-12x13
14x15-16x17 mm

188

Twaalkant ratel ringsleutels voor vliegwheels van dynamo



mm	L mm	€	Stuks	Art. No.
10	240	26,00	2	001880010
15	322	35,50	2	001880015

192

Omschakelbare ringratelsleutels, dubbele twaalkant ring, verchromd



mm	L mm	€	Stuks	Art. No.
8x10/12x13	160	33,00	1	001920008
16x17/18x19	230	42,50	1	001920016

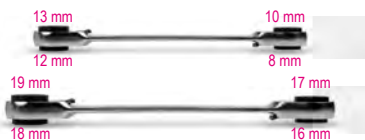

Art. No.	€	Stuks	Art. No.
192/S2	75,50	1	001920070

8x10/12x13 mm
16x17/18x19 mm

194

Omschakelbare ratelsleutel voor bits



mm	L mm	€	Stuks	Art. No.
1/4x5/16	128	41,50	2	001940006

195

Ringratelsleutel twaalkant ring



mm	L mm	€	Stuks	Art. No.
8x10	128	22,50	2	001950010
12x13	170	26,00	2	001950013
14x15	190	27,00	2	001950015
16x18	230	32,50	2	001950018
17x19	230	33,50	2	001950019



Art. No.	€	Stuks	Art. No.
195/B5	153,00	1	001950066

8x10-12x13-14x15
16x18-17x19 mm
195/BV5 11,30 1 001950070

195AS

Ringratelsleutels, plat met twaalkantring



mm	L mm	€	Stuks	Art. No.
5/16x3/8	128	23,20	2	001950606
7/16x1/2	170	26,00	2	001950611
9/16x5/8	190	28,50	2	001950614
11/16x3/4	230	33,00	2	001950617



Art. No.	€	Stuks	Art. No.
195AS/B4	122,00	1	001950654

5/16x3/8 - 7/16x1/2 -
9/16x5/8 - 11/16x3/4
195FTX/BV4 11,30 1 001950520

195P

Ringratelsleutels twaalkant met 15° gebogen uiteinden



mm	L mm	€	Stuks	Art. No.
8x10	128	35,00	2	001950210
12x13	170	36,50	2	001950213
14x15	190	38,00	2	001950215
16x18	230	42,00	2	001950218
17x19	230	44,00	2	001950219



Art. No.	€	Stuks	Art. No.
195P/B5	207,00	1	001950266

8x10-12x13-14x15
16x18-17x19 mm
195/BV5 11,30 1 001950070

310

Moflasapparaat voor PE, PP, PVC en PVDF pijpen en fittingen



mm	€	Stuks	Art. No.
310/2	464,00	1	003100002

230V-650 Watt
50 Hz=60Hz
Schuko (CEE 7/7)

310B

Bussen voor lasapparaat model 310

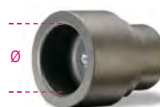

mm	€	Stuks	Art. No.
16	79,50	1	003100016
20	87,00	1	003100020
25	94,00	1	003100025
32	102,00	1	003100032
40	123,50	1	003100040
50	158,00	1	003100050
63	177,00	1	003100063



310/C8

Moflasapparaat met een 7-delig assortiment busen



310/C8
310/2+310B: Ø 16-20-25
32-40-50-63

€ 1.029,00
1 003100108

440x270x120 mm - 7,7 kg

311

Lasspiegel voor het recht en stomplassen van PE pijpen



CE

	Ø mm	Watt	€		
311/1	120	300	416,00	1	003110001
311/2	190	900	461,00	1	003110002

TOEPASSINGSGEBIED VAN DE PIJPSNIJDERS VAN BETA

De pijpsnijders van Beta zijn geschikt voor een breed scala aan toepassingen. Ze vertrouwen op nauwkeurige, soepele rollen en schroef- of telescopische aanzet om nauwkeurige, zuivere sneden mogelijk te maken op alle materialen die voor buizen worden gebruikt.

De onderstaande tabel toont de combinaties van pijpsnijder / snijwiel voor elk materiaal.

	STALEN GASLEIDINGEN			ROESTVAST STALEN GASBUIZEN		
	10 mm 1/8"	60 mm 2"	115 mm 4"	10 mm 1/8"	60 mm 2"	115 mm 4"
330/2						
330/4						
				330/2+330R/12		
				330/4+330R/14		

	KOPER EN LICHT GELEGERDE BUIZEN							
	3 mm 1/8"	6 mm 1/4"	8 mm 5/16"	16 mm 5/8"	28 mm 1 1/8"	30 mm 1 1/2"	38 mm 1 1/2"	67 mm 2 5/8"
332								
334								
336								
338								

	DUNWANDIGE ROESTVAST STALEN BUIZEN							
	3 mm 1/8"	6 mm 1/4"	8 mm 5/16"	16 mm 5/8"	28 mm 1 1/8"	30 mm 1 1/2"	38 mm 1 1/2"	67 mm 2 5/8"
332 + 334R/1								
334 + 334R/1								
336 + 338R/1								
338 + 338R/1								

	KUNSTSTOF BUIZEN							
	6 mm 1/4"	8 mm 5/16"	16 mm 5/8"	30 mm 1 1/8"	38 mm 1 1/2"	50 mm 2"	67 mm 2 5/8"	127 mm 5"
336 + 338RP								
338 + 338RP								
339A								

330

Pijpsnijders voor stalen gaspijp



	Ø mm -"	L mm	€		
330/2	10÷60 1/8"÷ 2"	380	181,00	1	003300002
330/4	60÷115 2"÷ 4"	585	423,00	1	003300004

330R/A

Reserve snijwiel voor model 330 voor staal pijpen



	Ø mm	S mm	€		
330R/A2	32	7	17,80	1	003300012
330R/A4	42	9	47,00	1	003300014

330R/1

Reserve snijwiel voor model 330 voor roestvast staal pijp



	Ø mm	S mm	€		
330R/12	32	7	40,00	1	003300024
330R/14	32	9	114,00	1	003300034

331C

Dragbare C-vormige pijpsnijder voor koperen en lichte legering buizen



	Ø mm	L mm	€		
15÷22	15÷22	78	66,50	1	003310050

Beta

332

Mini-pijpsnijder voor koperen en licht metalen pijp



Ø mm - "	L mm	€		
3÷16 1/8"±5/8"	59	26,00	2	003320001
3÷28 1/8"±1"1/8"	63	29,50	2	003320003

334

Pijpsnijder voor koperen en licht metalen pijp



Ø mm - "	L mm	€		
3÷30 1/8"±1"1/8"	150	35,00	1	003340001

334R

Reserve snijwiel voor model 332 en 334 voor koperen en licht metalen pijpen

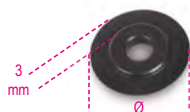

Ø mm	€		
334R 18	8,30	1	003340021

334R/I

Reserve snijwiel voor model 332 en 334 voor roestvast stalen pijpen



Ø mm	€		
334R/I 18	22,60	1	003340023

336

Pijpsnijder met telescopische schroefspindel voor koperen en zachtstalen pijp



Ø mm - "	L mm	€		
6÷38 1/4"±1"1/2"	160	57,50	1	003360001

338

Pijpsnijder met telescopische schroefspindel, snelinstelling voor koperen, licht metalen en kunststof pijpen



Ø mm - "	L mm	€		
6÷67 1/4"±2"5/8"	290	148,00	1	003380001

338R

Reserve snijwiel voor model 331L, 336 en 338 voor koperen en licht metalen pijpen



Ø mm	€		
338R 18,5	8,35	1	003380022

338R/I

Reserve snijwiel voor model 336 en 338 voor roestvast stalen pijpen

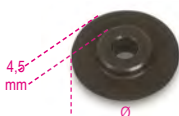

Ø mm	€		
338R/I 21,8	24,30	1	003380023

338RP

Reserve snijwiel voor model 336 en 338 voor kunststof pijpen



Ø mm	€		
338RP 21,9	9,10	1	003380025

339A

Pijpsnijder met telescopische schroefspindel, snelinstelling voor kunststof pijpen



Ø mm - "	L mm	€		
50÷127 2"±5"	345	335,00	1	003390011

339A/R

Reserve snijwiel voor artikel 339A

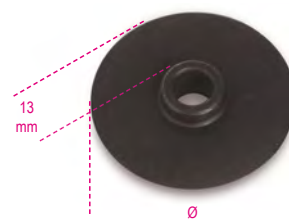

339A/R	Ø mm	€		
	42	23,90	1	003390061

340

Meerlaags pijpsnijtang, max. Ø 26 mm

Messen voorzien van PTFE-coating
4 ondersteunende rollen vereenvoudigen het draaien van de pijp tijdens het snijden.
Draai systeem voor het snijden van geribbelde slangen in de handgreep.
Lichtgewicht, vervaardigd uit magnesium



Ø max mm	€		
340 26	130,50	1	003400001

340RL

Reserve mes voor artikel 340



340RL	€		
	36,50	1	003400010

340C

Pijpsnijder voor mantelbuis

tang gemaakt van gelegeerd aluminium en magnesium

- compact, zakformaat, lichtgewicht
- extra mes voor snijden in de lengte



Ø mm	L mm	€		
14-45	134	62,50	1	003400050

340C/KRL

set van 3 reservemesjes voor 340C



340C/KRL	€		
	38,00	1	003400055

341

Pijpsnijdtang voor kunststof pijpen



Ø mm	L mm	€		
0÷25	190	44,00	1	003410001

341RL

Reserve mes voor model 341



341RL	€		
	21,40	1	003410010

341B

Pijpsnijder met ratel voor kunststof pijpen



Ø mm	L mm	€		
0÷35	195	80,00	1	003410051

341B/RM

Reserve veer voor model 341B

341B/RM	€		
	3,25	1	003410061

341B/RL

Reserve mes voor model 341B



341B/RL	€		
	31,00	1	003410060

342

Pijpsnijder met ratel voor kunststof pijpen



Ø mm - "	L mm	€		
0÷42 1"5/8	200	58,50	1	003420030

342MOL

Reserve veer voor item 342

342MOL	€		
	4,25	1	003420033

342RL

Reserve mes voor item 342



342RL	€		
	27,00	1	003420032

342A

Pijpsnijder met ratel voor kunststof pijpen



Ø mm - "	L mm	€		
0÷50 2"	270	125,00	1	003420101

342A/MOL

Reserve veertje voor artikel 342A

342A/MOL	€		
	2,68	1	003420111

342A/RL

Reserve mes voor model 342A



342A/RL	€		
	66,50	1	003420110

342P

Pijpsnijder met ratel voor kunststof pijpen, vervaardigd uit magnesium legering



Ø mm - "	L mm	€		
0÷50 2"	260	141,00	1	003420121

342P/RL

Reserve mes voor item 342P



342P/RL	€		
	58,50	1	003420130

Beta

345

Pijpruimer metalen huis



Ø mm - "	L mm	€	🔧	📄
3÷42 1/8"÷1"5/8	58	33,00	5	003450001

345U

Pijpruimer voor roestvaststaal, staal, koper en lichte legeringen



Ø mm - "	L mm	€	🔧	📄
4÷36 5/32÷1"7/16	60	89,50	1	003450050

345U/A

adapter voor pijpruimer 345U, 1/4" zeshoekige aandrijving, voor powerdrivers



L mm	€	🔧	📄
90	23,10	3	003450055

345C

Radiator sleutel met handvat



Ø mm	L mm	€	🔧	📄
16-20-26-32		54,50	1	003450032

345SB

Ontbramer met vervangbare messen



L mm	€	🔧	📄
150	28,00	5	003450010

345SB/R

Reserve mes voor model 345SB



345SB/R	€	🔧	📄
	9,90	3	003450015

345SB2

ontbramer met vast mes



L mm	€	🔧	📄
140	14,10	5	003450022

345SC

4-in-1 borstel voor binnen- en buitendiameters, 1/2" en 3/4"



L mm	L1 mm	L2 mm	€	🔧	📄
195	28	32	16,50	2	003450060

345SI

ontbramer voor intern gebruik, met draaiend reservemes



L mm	Ø mm	€	🔧	📄
168	16,5	54,00	1	003450040

345SI/R

reservemes voor artikel 345SI



345SI/R	€	🔧	📄
	37,50	1	003450045

349

Felsapparaat met boormachine aansluiting, voor koperen en zacht metalen pijpen



Ø mm - "	€	🔧	📄
6-8-10-12-14-15-16-18 (1/8-3/16-1/4-5/16 3/8-1/2-5/8-3/4)	332,00	1	003490001

270x200x50 mm - 2,7 kg

349/SMM

Matrijs in metrisch voor item 349



Ø mm	€	🔧	📄
6-8-10-12-14-15-16-18	96,50	1	003490011

349/SMAS

Matrijs in inch voor item 349



Ø mm	€	🔧	📄
1/8-3/16-1/4-5/16 3/8-1/2-5/8-3/4	93,50	1	003490012

350

Felsapparaat voor koperen en zacht metalen pijpen



Ø mm	L mm	A mm	€	1	003500001
4-4,75-6-8	175	104	94,00		
10-12-14					

351C

Pijpsnijder en felsapparaat



351C	€	1	003510010
	166,50		

334	Ø 3+30 mm (1/8"+1"1/8)
350	Ø 4+14 mm
351P	Ø 4-4,75-6-8-10-12-14 mm

225x150x45 mm - 1,6 kg

351P

Stempels voor felsapparaat model 350



351P	Ø mm	€	3	003510101
4	4	7,95		
4,75	4,75	7,95		
6	6	7,95		
8	8	7,95		
10	10	7,95		
12	12	7,95		
14	14	7,95		

352U

Verstelbaar felsapparaat voor koperen en zacht metalen pijpen



Ø mm - "	A mm	€	1	003520101
5÷16	130	109,00		
3/16÷5/8				

352C/U

Pijpsnijder, ontbramer en verstelbaar felsapparaat



352C/U	€	1	003520110
	216,50		

334	Ø 3+30 mm (1/8"+1"1/8)
345SB	
352U	Ø 5+16 mm (3/16"+5/8")

335x145x60 mm - 2120 g

355

Radiatorsleutel, 5 stappen



Ø"	L mm	€	2	003550001
3/8"-1/2"	90	42,00		
3/4"-1"				

357F3

Waterpas met drie libellen

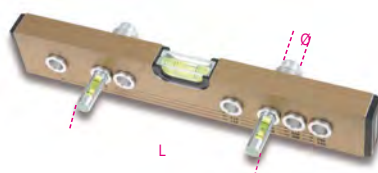

Ø"	L mm	€	1	003570100
3/8" / 1/2"	90÷220	146,00		

357R/F3

Reserve libel voor artikel 357F3



357R/F3	€	1	003570101
	23,00		

358

Ontbraamapparaten voor kunststof pijpen



358/1	Ø mm	€	1	003580001
	16÷110	203,00		
358/2	Ø mm	€	1	003580002
	40÷250	203,00		

358RL

Reserve mes voor modellen 358/1 en 358/2



358RL	€	1	003580011
	38,00		

359

Universele afvoersleutel



Ø"	L mm	A mm	€	1	003590001
1"÷1"1/4	160	140	103,00		

Beta

359CH

Afvoer hulpstuk, kruisvorm vervaardigd voor model 359



Ø mm	L mm	€		
1"1/2	74	58,00	1	003590005

360

Pijptangen, Stillson model



L mm	Ø max"	Ø max mm	€		
250	1" gas	34	40,00	1	003600025
350	1"1/2 gas	49	54,00	1	003600035
450	2" gas	60	73,00	1	003600045
600	2"1/2 gas	76	112,00	1	003600060
900	3"1/2 gas	102	312,00	1	003600090

360R/...

Onderdelen kit voor artikel 360 met beweegbare bek en draaimoer.

	€		
360R 250	15,50	1	003600025
360R 350	21,10	1	003600035
360R 450	31,00	1	003600045
360R 600	45,50	1	003600060
360R 900	80,50	1	003600090

361N

Verstelbare pijptang



L mm	Ø max"	Ø max mm	€		
350	1" 1/2	49	89,00	1	003610014

362

Pijptangen, Amerikaans model



L mm	Ø max"	Ø max mm	€		
200	1" gas	34	35,00	1	003620020
250	1"1/2 gas	49	44,00	1	003620025
300	2" gas	60	53,50	1	003620030
350	2" gas	60	62,00	1	003620035
450	2"1/2 gas	76	91,00	1	003620045
600	3" gas	90	138,00	1	003620060
900	5" gas	140	168,00	1	003620090

362R/...

Onderdelen kit voor artikel 362 met vaste bek, beweegbare bek en draaimoer en borgpen.

	€		
362R 200	8,10	1	003620220
362R 225	10,90	1	003620225
362R 300	13,40	1	003620230
362R 350	16,00	1	003620235
362R 450	21,90	1	003620245
362R 600	28,50	1	003620260
362R 900	70,50	1	003620290

363

Pijptangen, Amerikaans model, met smeedstalen bekken



L mm	Ø max"	Ø max mm	€		
350	2" gas	60	77,00	1	003630035
450	2"1/2 gas	76	104,50	1	003630045
600	3" gas	90	185,50	1	003630060
900	5" gas	140	323,00	1	003630090
1200	6" gas	165	351,00	1	003630120

363R/...

Onderdelen kit voor artikel 363 met: vaste bek, beweegbare bek, draaimoer en borgpen.

	€		
363R 350	17,10	1	003630035
363R 450	23,00	1	003630045
363R 600	32,50	1	003630060
363R 900	63,50	1	003630090
363R 1200	98,50	1	003630320

365

Pijptangen, zware uitvoering, haaks model met smeedstalen bekken

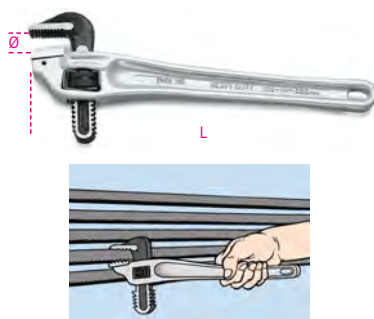

L mm	Ø max"	Ø max mm	€		
350	2" gas	60	101,00	1	003650035
450	2"1/2 gas	76	140,50	1	003650045

365R/...

Onderdelen kit voor artikel 365 met: vaste bek, beweegbare bek, draaimoer en borgpen.

	€		
365R 350	73,00	1	003650235
365R 450	112,50	1	003650245

366

Pijptangen, licht model



L mm	Ø max"	Ø max mm	€		
175	1" gas	34	37,50	1	003660017
225	1"1/2 gas	49	42,50	1	003660022
275	2" gas	60	53,50	1	003660027
300	2"1/2 gas	76	57,50	1	003660030
350	3" gas	90	63,00	1	003660035

374

Pijptangen, Zweeds model, 45° gebogen dunne bekken



DIN 5234

L mm	Ø max"	Ø max mm	€		
240	1/2" gas	21	42,50	1	003740024
320	1" gas	34	58,00	1	003740032
410	1"1/2 gas	49	76,00	1	003740041
550	2" gas	60	118,00	1	003740055
630	3" gas	90	213,50	1	003740063

375

Pijptang, Zweeds model, 45° gebogen platte bekken



DIN 5234

L mm	Ø max"	Ø max mm	€		
320	1" gas	34	58,00	1	003750032
410	1"1/2 gas	49	76,00	1	003750041
550	2" gas	60	118,00	1	003750055

376

Pijptangen, Zweeds model, 90° gebogen rechte bekken



DIN 5234

L mm	Ø max"	Ø max mm	€		
320	1" gas	34	58,00	1	003760032
410	1"1/2 gas	49	76,00	1	003760041
550	2" gas	60	117,50	1	003760055
630	3" gas	90	216,00	1	003760063

378

Pijpentangen, Zweeds model,
45° gebogen dunne bekken



DIN 5234

L mm	Ø max " gas	Ø max mm	€	1	003780025
250	1/2"	21	44,50	1	003780025
320	1" gas	34	60,00	1	003780032
410	1 1/2" gas	49	79,00	1	003780041
550	2" gas	60	127,50	1	003780055
650	3" gas	90	222,00	1	003780065

374R/...

complete onderdelen kits voor artikelen 374
- 375 - 376 - 378
met draaimoer en borgring

	€	1	003740724
374R 240 x 374/240-378/250	2,57	1	003740724
374R 320 x 374/320-376/320-378/320	3,10	1	003740732
374R 410 x 374/410-375/410-376/410-378/410	3,90	1	003740741
374R 550 x 374/550-376/550-378/550	4,45	1	003740755
374R 630 x 374/630-378/650	6,40	1	003740763

383

Spanbandsleutel smeedstalen arm



383/1	383/2
Ø max " gas	Ø max mm
3"	8" gas
90	220
300	300
€ 61,50	€ 65,00
1 003830001	1 003830002

383R

Reserve banden voor model 383

383R/1	383R/2
S mm	S mm
27	27
€ 25,50	€ 27,50
1 003830010	1 003830015

384

Dubbelwerkende kettingtang.



Ø max " gas	Ø max mm	L mm	€	1	003840032
4"	115	300	81,50	1	003840032

384RC

Reserve ketting voor 384



384RC	€	1	003840033
	49,50	1	003840033

386A

Dubbelwerkende kettingtangen



386A/1	386A/2	386A/5	386A/6
Ø max " gas	Ø max " gas	Ø max " gas	Ø max " gas
4"	6"	8"	12"
115 mm	168 mm	220 mm	324 mm
L mm 900	L mm 900	L mm 1100	L mm 1300
€ 249,00	€ 439,00	€ 652,00	€ 1.127,00
1 003860001	1 003860002	1 003860005	1 003860006

386A/RC

Reserve ketting voor artikel 386A



386A1/RC	386A2/RC	386A5/RC	386A6/RC
€ 75,00	€ 105,00	€ 165,00	€ 292,00
1 003860011	1 003860012	1 003860015	1 003860016

Beta

387

pijpenbuiger voor koperen en non-ferro
metalen buizen,
met verwisselbare vormen
3/16"-1/4"-5/16"-3/8"



L mm	Ø mm	€	1	003870001
255	3/16"-1/4"-5/16"-3/8"	57,00	1	003870001

387R

reserve wielen voor item 387



Ø "	€	1	003870010
3/16"-1/4"	14,20	1	003870010
5/16"-3/8"	15,10	1	003870015

388

Pijpenbuigtangen voor dunwandige koperen
pijp, lichte legering en zacht stalen pijpen



Ø mm	L mm	R mm	€	1	003880006
6	305	18,0	68,50	1	003880006
8	315	23,5	74,50	1	003880008
10	350	31,0	87,00	1	003880010
12	360	31,0	91,00	1	003880012
14	455	46,5	119,50	1	003880014
15	465	46,5	126,50	1	003880015
16	465	46,5	135,50	1	003880016

388A

Pijpenbuigtang voor dunwandig
koperen, zacht metalen en zacht
stalen pijp



388A/1	388A/2
Ø mm 6-8-10	Ø mm 1/4"-5/16"-3/8"
L mm 220	L mm 220
€ 77,00	€ 77,00
1 003880051	1 003880055

388C/C8

Pijpenbuigtang met 7 vormen voor dunwandige koperen en lichtstalen legering pijpen.



388C/C8	∅ mm 10-12-14-16 18-20-22	€ 550,00	1	003880200
---------	---------------------------------	-------------	---	-----------

400x330x110 mm - 3,6 kg

389/K4

set pijpbuigveren voor koperen leidingen voor extern gebruik



1/4-3/8-1/2-5/8	L mm 290	€ 23,50	1	003890001
-----------------	-------------	------------	---	-----------

392C

Verstelbare sifontang



∅ mm 25+65	L mm 260	€ 55,00	1	003920100
---------------	-------------	------------	---	-----------

392RG/C

Reserve bekbechermers voor artikel 392C, paar



392RG/C	€ 7,25	1	003920101
---------	-----------	---	-----------

Beta

393

Wastafelmoertang



L mm 270	€ 81,00	1	003930001
-------------	------------	---	-----------

395

Wastafelmoersleutel

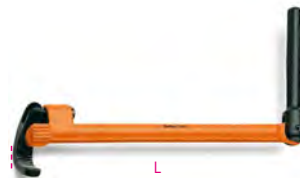

∅ mm 15+32 mm 5/8"±1"1/4	L mm 240	€ 52,50	1	003950001
--------------------------------	-------------	------------	---	-----------

395T

Wastafelmoersleutel, telescopische model



∅ mm 10+32 mm 3/8"±1"1/4	L mm 250+430	€ 68,50	1	003950100
--------------------------------	-----------------	------------	---	-----------

398

Werkbank kettingklem



∅ mm 1/2+8"	L mm 250	€ 358,00	1	003980008
----------------	-------------	-------------	---	-----------

399

Pijpenklemmen



∅ mm 10+60 mm 1/8+2"	L min mm 220	€ 223,00	1	003990005
10+89 mm 1/8+3"	290	409,00	1	003990010

399R/...

Reserve bekken voor artikel 399 samengesteld uit twee onderste bekken en een bovenste bek



399RG 1/8-2"	€ 28,00	1	003990105
399RG 1/8-3"	44,00	1	003990110

Beta

Beta

GRAFIEK VOOR METALEN SPIRAAL BOREN

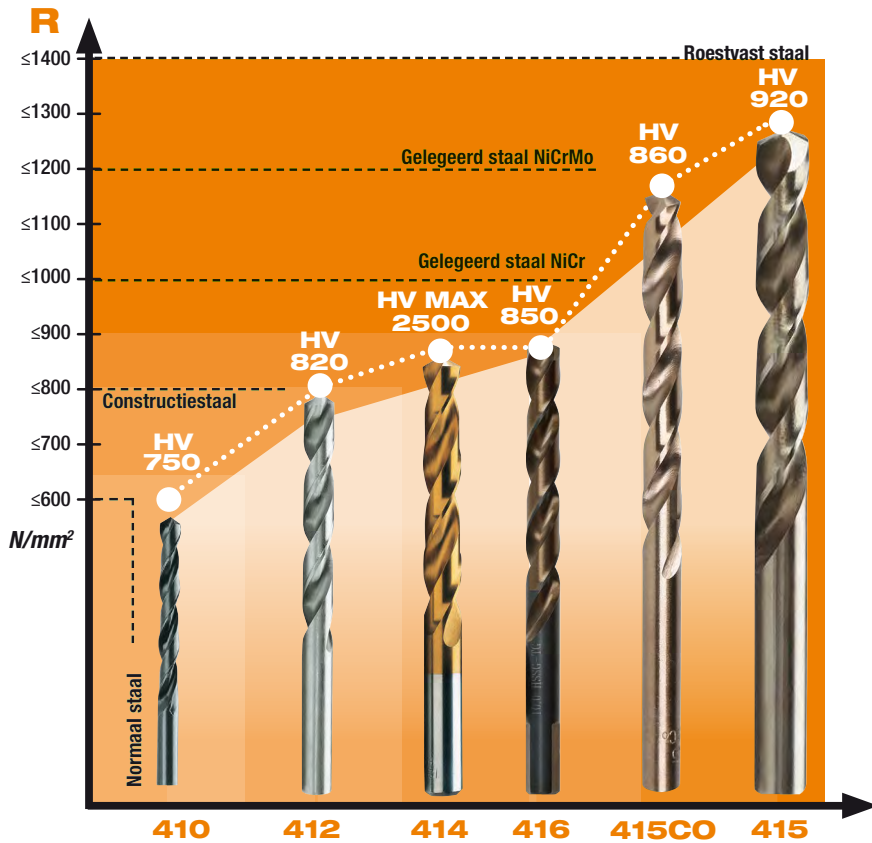

R N / mm² - Mechanische weerstand van het te boren materiaal.

HV - Spiraalboorhardheid volgens de Vickers-schaal: hoe hoger de waarde, hoe hoger de hardheid van het materiaal.

GIDS VOOR TWISTBOREN MET CILINDRISCHE SCHACHTEN

Gewalste spiraalboren - Spiraalboren verkregen uit een warmgewalst fabricageproces. Kwalitatief hoogwaardige spiraalboren, voor gebruik voor lichte klussen, bijv. boren van ijzer, zacht staal, lichte legeringen en non-ferrometalen in het algemeen.

Geslepen spiraalboren - Spiraalboren die volledig zijn verkregen door slijpen uit een warme behandelde stalen staaf. Krachtige spiraalboren, voor het boren van staal en lichte legeringen: constant rendement, uitstekende spaanafvoer en boorprecisie.

HSS - staal voor hoge snelheden, extreem hard en bestand tegen hoge temperaturen; het beste materiaal voor snij-, tap- en draadsnijgereedschap.

Kobalt (Co) - Een basis legeringselement, dat staal een verbeterde hittebestendigheid geeft en de spiraalboorslijtage vermindert, b.v. bij hoge temperaturen. Hoe hoger het kobaltgehalte, hoe beter de prestaties van het gereedschap. De meest gebruikte legeringen hebben een kobaltgehalte van 5% of 8%.

HSS-Co - staal met een kobaltgehalte van 5% of 8%.

TiN - Ultradunne coating van titaniumnitride; op basis van zijn hoge hardheid en lage wrijvingsfactor, biedt het een verhoogde weerstand tegen slijtage en oxidatie en een verbeterde verwijdering van boorspanen.

Chroomstaal - Gereedschappen gemaakt van chroomstaal zijn geschikt voor handmatig gebruik voor het draadsnijden van ijzer, lichte legeringen, onbehandeld staal en staal met warmtebehandeling bij lage hardheid. Ze worden veel gebruikt voor het reinigen en repareren van beschadigde schroefdraden bij alle professionele klussen in het algemeen en in de automobielsector in het bijzonder.

Hardmetaal - Materiaal met hoge slijtvastheid, gebruikt voor platen in betonboren.

118 ° geslepen - Standaard slijphoek van spiraalboren voor metaal, waardoor snel in metalen kan worden geboord, voor eenvoudiger centreren en uitstekende warmteafvoer.

130 ° geslepen - Brede slijphoek, voor meer precisie bij eerste boorbewerkingen en waarbij minder boorkracht nodig is.

Dubbele 115 ° / 135 ° geslepen - Gecombineerde voordelen van de twee hoeken, plus spaanbrekingsfunctie; de beste keuze voor materialen met lange spanen.

SDS-Plus - Snelle, veilige schacht aansluiting voor hamerboren.

410

Spiraalboren, korte uitvoering
HSS gewalst

$R \leq 650$ N/mm²
 $HV \sim 750-820$



DIN 338 ISO 235

Ø mm	L mm	L1 mm	€	U	U
0,50	22	6	1,85	10	004100030
1,00	34	12	1,07	10	004100040
1,25	38	16	0,84	10	004100043
1,50	40	18	0,83	10	004100046
1,75	46	22	0,83	10	004100049
2,00	49	24	0,74	10	004100052
2,25	53	27	0,83	10	004100055
2,50	57	30	0,83	10	004100058
2,75	61	33	0,83	10	004100061
3,00	61	33	0,83	10	004100064
3,20	65	36	1,13	10	004100066
3,25	65	36	1,13	10	004100067
3,50	70	39	1,10	10	004100070
3,75	70	39	1,20	10	004100073
4,00	75	43	1,13	10	004100076
4,20	75	43	1,42	10	004100078
4,25	75	43	1,42	10	004100079
4,50	80	47	1,22	10	004100082
4,75	80	47	1,48	10	004100085
5,00	86	52	1,39	10	004100088
5,25	86	52	1,97	10	004100091
5,50	93	57	1,85	10	004100094
5,75	93	57	2,04	10	004100097
6,00	93	57	1,85	10	004100100
6,25	101	63	2,49	10	004100103
6,50	101	63	2,24	10	004100106
6,75	109	69	2,88	10	004100109
7,00	109	69	2,57	10	004100112
7,50	109	69	2,77	10	004100118
8,00	117	75	3,35	10	004100124
8,50	117	75	3,45	10	004100130
9,00	125	81	4,25	5	004100136
9,50	125	81	4,50	5	004100142
10,00	133	87	5,15	5	004100148
10,50	133	87	6,20	5	004100172
11,00	142	94	7,20	5	004100184
11,50	142	94	7,50	5	004100196
12,00	151	101	8,10	5	004100210
12,50	151	101	9,10	5	004100222
13,00	151	101	9,75	5	004100234
14,00	160	108	12,70	5	004100242
15,00	169	114	14,90	5	004100250
16,00	178	120	18,60	5	004100258
17,00	184	125	20,10	3	004100262
18,00	191	130	24,00	3	004100266
19,00	198	135	26,50	3	004100270
20,00	205	140	33,00	3	004100274



	€	U	U
410/SP19 Ø 1÷10 x 0,5 mm	49,00	1	004100419
410/SPVP1	29,00	1	004100421
410/SP25 Ø 1÷13 x 0,5 mm	99,00	1	004100425
410/SPVP2	39,00	1	004100427



410/SEL19 € 39,00 1 004100418
 Ø 1÷10 x 0,5 mm

410MIX/SEL19

13-delig borensset item 410
 en 6 steenboren hardmetaal



410MIX/SEL19 € 37,00 1 004100417



Ø 1 - 1,5 - 2 - 2,5 - 3 - 3,5 - 4
 4,5 - 5 - 5,5 - 6 - 8 - 10 mm

Ø 4 - 5 - 6 - 8 - 9 - 10 mm

410A

Spiraalboren,
 korte uitvoering, HSS, gewalst,
 met gereduceerde schacht

R ≤ 650 N/mm²
 HV ~ 750+820



DIN 338 ISO 235

Ø mm	L mm	L1 mm	€		
13,50	160	108	14,90	5	004100281
14,00	160	108	14,90	5	004100283
14,50	169	114	17,30	5	004100285
15,00	169	114	17,30	5	004100287
15,50	178	120	20,90	5	004100289
16,00	178	120	20,90	5	004100291
16,50	184	125	22,40	3	004100292
17,00	184	125	22,40	3	004100293
17,50	191	130	26,00	3	004100294
18,00	191	130	26,00	3	004100295
18,50	198	135	31,00	3	004100296
19,00	198	135	31,00	3	004100297
19,50	205	140	35,00	3	004100298
20,00	205	140	35,00	3	004100299

410AS

Spiraalboren,
 korte uitvoering, HSS, gewalst,
 in inches

R ≤ 650 N/mm²
 HV ~ 750+820



ANSI B94

Ø"	L mm	L1 mm	€		
1/16	48	22	0,70	10	004100371
5/64	51	25	0,79	10	004100372
3/32	57	32	0,92	10	004100373
7/64	67	38	1,00	10	004100374
1/8	70	41	1,13	10	004100375
9/64	73	44	1,26	10	004100376
5/32	79	51	1,33	10	004100377
11/64	83	54	1,48	10	004100378
3/16	89	59	1,65	10	004100379
13/64	92	62	1,72	10	004100380
7/32	95	64	1,92	10	004100381
15/64	98	67	2,18	10	004100382
1/4	102	70	2,50	10	004100383
17/64	105	73	2,82	10	004100384
9/32	108	75	3,05	10	004100385
19/64	111	78	3,55	10	004100386
5/16	114	81	4,20	10	004100387
21/64	117	84	4,35	10	004100388
11/32	121	87	5,30	5	004100389
23/64	124	89	5,35	5	004100390
3/8	127	92	5,65	5	004100391



410AS/SP21 € 72,00 1 004100429
 Ø 1/16-5/64-3/32-7/64
 1/8-9/64-5/32-11/64-3/16
 13/64-7/32-15/64-1/4
 17/64-9/32-19/64-5/16
 21/64-11/32-23/64-3/8
 410AS/SPV1 29,50 1 004100430



410AS/SEL21 € 57,00 1 004100433
 Ø 1/16-5/64-3/32-7/64
 1/8-9/64-5/32-11/64-3/16
 13/64-7/32-15/64-1/4
 17/64-9/32-19/64-5/16
 21/64-11/32-23/64-3/8

412

Spiraalboren, korte uitvoering HSS
 volledig geslepen glimmende afwerking

R ≤ 800 N/mm²
 HV ~ 750+820



DIN 338 ISO 235

Ø mm	L mm	L1 mm	€		
0,50	22	6	3,20	10	004120030
1,00	34	12	2,05	10	004120040
1,25	38	16	2,25	10	004120043
1,50	40	18	1,85	10	004120046
1,75	46	22	1,50	10	004120049
2,00	49	24	1,56	10	004120052
2,25	53	27	1,97	10	004120055
2,50	57	30	1,69	10	004120058
2,75	61	33	2,07	10	004120061
3,00	61	33	1,79	10	004120064
3,25	65	36	2,43	10	004120067
3,50	70	39	2,15	10	004120070
3,75	70	39	2,62	10	004120073
4,00	75	43	2,43	10	004120076
4,25	75	43	2,94	10	004120079
4,50	80	47	2,79	10	004120082
4,75	80	47	3,30	10	004120085
5,00	86	52	2,94	10	004120088
5,25	86	52	4,15	10	004120091
5,50	93	57	4,00	10	004120094
5,75	93	57	4,70	10	004120097
6,00	93	57	4,05	10	004120100
6,25	101	63	5,80	10	004120103
6,50	101	63	5,05	10	004120106
6,75	109	69	6,65	10	004120109
7,00	109	69	5,95	10	004120112
7,25	109	69	7,35	5	004120115
7,50	109	69	6,25	5	004120118
7,75	117	75	8,20	5	004120121
8,00	117	75	7,65	5	004120124
8,25	117	75	9,10	5	004120127
8,50	117	75	9,30	5	004120130
8,75	125	81	10,40	5	004120133
9,00	125	81	9,85	5	004120136
9,25	125	81	11,30	5	004120139
9,50	125	81	10,20	5	004120142
9,75	133	87	12,70	5	004120145
10,00	133	87	11,40	5	004120148
10,25	133	87	17,40	5	004120149
10,50	133	87	15,40	5	004120150
10,75	142	94	20,40	5	004120151
11,00	142	94	18,20	5	004120152
11,25	142	94	22,00	5	004120153
11,50	142	94	19,20	5	004120154
11,75	142	94	23,60	5	004120155
12,00	151	101	21,10	5	004120156
12,25	151	101	25,50	5	004120157
12,50	151	101	22,50	5	004120158
12,75	151	101	29,00	5	004120159
13,00	151	101	24,20	5	004120160



412/SP19 € 99,00 1 004120419
 Ø 1÷10 x 0,5 mm
 410/SPVP1 29,00 1 004100421
 412/SP25 205,00 1 004120425
 Ø 1÷13 x 0,5 mm
 410/SPVP2 39,00 1 004100427
 412/SP49 495,00 1 004120449
 Ø 1÷13 x 0,25 mm
 412/SPV4 115,00 1 004120451



412/C150



412/C150 € 629,00 1 004120450

412 Ø 3 mm n.
Ø 1 - 1,5 - 2 - 2,5 - 3 - 3,5 - 4 - 4,5 - 5 mm 20
Ø 5,5 - 6 - 6,5 - 7 - 7,5 - 8 - 8,5 - 9 - 9,5 - 10 mm 5

365x230x47 mm - 3,3 kg



412/SP91 € 625,00 1 004120452

Ø 1÷10 x 0,10 mm

412A

Spiraalboren , korte uitvoering,
HSS, volledig geslepen, gebruneerd,
met gereduceerde schacht

R ≤ 800 N/mm²
HV ~ 750÷820



DIN 338 ISO 235

Ø mm	L mm	L1 mm	€	U	U
13,50	160	108	37,50	3	004120202
14,00	160	108	37,50	3	004120204
14,50	169	114	41,00	3	004120206
15,00	169	114	43,50	3	004120208
15,50	178	120	50,50	3	004120210
16,00	178	120	53,50	3	004120212
16,50	184	125	53,50	1	004120213
17,00	184	125	56,50	1	004120214
17,50	191	130	60,00	1	004120215
18,00	191	130	65,50	1	004120216
18,50	198	135	70,00	1	004120217
19,00	198	135	72,00	1	004120218
19,50	205	140	81,00	1	004120219
20,00	205	140	83,00	1	004120220

412L

Spiraalboren, lange uitvoering HSS
volledig geslepen gebruneerd

R ≤ 800 N/mm²
HV ~ 750÷820



DIN 340

Ø mm	L mm	L1 mm	€	U	U
2,00	85	56	4,20	10	004120232
2,50	95	62	4,40	10	004120234
3,00	100	66	4,60	10	004120236
3,50	112	73	5,45	10	004120238
4,00	119	78	5,85	10	004120240
4,50	126	82	7,20	10	004120242
5,00	132	87	7,65	10	004120244
5,50	139	91	9,30	10	004120246
6,00	139	91	10,10	10	004120248
6,50	148	97	12,10	5	004120250
7,00	156	102	14,00	5	004120252
8,00	165	109	18,50	5	004120256
9,00	175	115	21,70	5	004120260
10,00	184	121	23,80	5	004120264

412XL

Spiraalboren met ronde schacht,
extra-lange uitvoering, HSS,
volledig geslepen

R ≤ 800 N/mm²
HV ~ 750÷820



DIN 1869/1

Ø mm	L mm	L1 mm	€	U	U
3,00	150	100	15,30	1	004120520
3,50	165	115	16,80	1	004120522
4,00	175	120	16,80	1	004120524
4,50	185	125	17,30	1	004120526
5,00	195	135	17,30	1	004120528
5,50	205	140	21,00	1	004120530
6,00	205	140	21,00	1	004120532
6,50	215	150	25,00	1	004120534
7,00	225	155	29,00	1	004120536
7,50	225	155	33,50	1	004120538
8,00	240	165	36,00	1	004120540
8,50	240	165	37,50	1	004120542
9,00	250	175	49,50	1	004120544
9,50	250	175	52,00	1	004120546
10,00	265	185	52,00	1	004120548
10,50	265	185	52,00	1	004120550
11,00	280	195	52,00	1	004120552
12,00	295	205	66,50	1	004120556
13,00	295	205	69,50	1	004120560



414

Spiraalboren, korte uitvoering HSS-TiN
volledig geslepen

R ≤ 900 N/mm²
HV 0,05 ~ 2500



DIN 338 ISO 235

Ø mm	L mm	L1 mm	€	U	U
1,00	34	12	2,63	10	004140040
1,25	38	16	3,20	10	004140042
1,50	40	18	2,50	10	004140046
1,75	46	22	3,20	10	004140048
2,00	49	24	2,62	10	004140052
2,25	53	27	3,30	10	004140054
2,50	57	30	2,68	10	004140058
2,75	61	33	3,75	10	004140060
3,00	61	33	3,05	10	004140064
3,25	65	36	3,75	10	004140066
3,50	70	39	3,55	10	004140070
3,75	70	39	4,15	10	004140072
4,00	75	43	3,55	10	004140076
4,25	75	43	4,60	10	004140078
4,50	80	47	4,15	10	004140082
4,75	80	47	5,10	10	004140084
5,00	86	52	4,75	10	004140088
5,25	86	52	6,75	10	004140090
5,50	93	57	5,75	10	004140094
5,75	93	57	7,20	10	004140096
6,00	93	57	6,50	10	004140100
6,25	101	63	8,35	10	004140102
6,50	101	63	7,45	10	004140106
6,75	109	69	9,90	10	004140108
7,00	109	69	8,00	10	004140112
7,25	109	69	11,00	5	004140114
7,50	109	69	9,65	5	004140118
7,75	117	75	12,60	5	004140120
8,00	117	75	11,20	5	004140124
8,25	117	75	13,20	5	004140125
8,50	117	75	11,50	5	004140130
8,75	125	81	16,40	5	004140132
9,00	125	81	14,40	5	004140136
9,25	125	81	18,30	5	004140138
9,50	125	81	16,40	5	004140142
9,75	133	87	19,10	5	004140144
10,00	133	87	17,00	5	004140148
10,50	133	87	20,20	5	004140150
11,00	142	94	22,20	5	004140152
11,50	142	94	23,70	5	004140154
12,00	151	101	26,00	5	004140156
12,50	151	101	30,00	5	004140158
13,00	151	101	31,00	5	004140160



€	U	U
149,00	1	004140419
29,00	1	004100421
309,00	1	004140425
39,00	1	004100427
665,00	1	004140429
119,00	1	004140430

414/C116



414/C116 € 609,00 1 004140450

414	Ø 1 - 1,5 - 2 - 2,5 - 3 - 3,5 - 4 - 4,5 - 5 mm	n.
	Ø 5,5 - 6 - 6,5 - 7 - 7,5 - 8 mm	3
	Ø 8,5 - 9 - 9,5 - 10 mm	2

365x230x47 mm - 2,7 Kg

415

Spiraalboren, korte uitvoering HSS-CO 8% volledig geslepen

R ≤ 1400 N/mm²
HV ~ 850+920

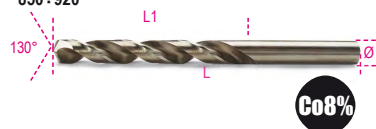

Co8%

DIN 338 ISO 235

Ø mm	L mm	L1 mm	€	Hand	Machine
0,50	22	6	7,70	10	004150029
1,00	34	12	3,80	10	004150040
1,25	38	16	4,25	10	004150043
1,50	40	18	3,80	10	004150046
1,75	46	22	4,05	10	004150049
2,00	49	24	3,75	10	004150052
2,25	53	27	4,60	10	004150055
2,50	57	30	4,25	10	004150058
2,75	61	33	4,60	10	004150061
3,00	61	33	4,20	10	004150064
3,25	65	36	5,85	10	004150067
3,50	70	39	5,55	10	004150070
3,75	70	39	6,40	10	004150073
4,00	75	43	5,85	10	004150076
4,25	75	43	7,25	10	004150079
4,50	80	47	6,65	10	004150082
4,75	80	47	7,70	10	004150085
5,00	86	52	7,20	10	004150088
5,25	86	52	10,60	10	004150091
5,50	93	57	9,55	10	004150094
5,75	93	57	11,00	10	004150097
6,00	93	57	10,00	10	004150100
6,25	101	63	14,10	10	004150103
6,50	101	63	12,60	10	004150106
6,75	109	69	16,00	10	004150109
7,00	109	69	14,80	10	004150112
7,25	109	69	17,20	5	004150115
7,50	109	69	15,50	5	004150118
7,75	117	75	20,30	5	004150121
8,00	117	75	18,30	5	004150124
8,25	117	75	22,10	5	004150127
8,50	117	75	20,50	5	004150130
8,75	125	81	27,00	5	004150133
9,00	125	81	24,50	5	004150136
9,25	125	81	28,00	5	004150139
9,50	125	81	25,50	5	004150142
9,75	133	87	30,50	5	004150145
10,00	133	87	28,00	5	004150148
10,25	133	87	37,00	5	004150149
10,50	133	87	32,00	5	004150150
10,75	142	94	42,50	5	004150151
11,00	142	94	36,50	5	004150152
11,25	142	94	46,50	5	004150153
11,50	142	94	42,00	5	004150154
11,75	142	94	48,50	5	004150155

Ø mm	L mm	L1 mm	€	Hand	Machine
12,00	151	101	45,00	5	004150156
12,25	151	101	56,00	5	004150157
12,50	151	101	47,50	5	004150158
12,75	151	101	60,50	5	004150159
13,00	151	101	53,50	5	004150160
14,00	160	108	90,50	3	004150164
15,00	169	114	106,00	3	004150168
16,00	178	120	132,00	3	004150172
17,00	186	125	148,00	1	004150174
18,00	194	130	165,00	1	004150176
19,00	202	135	188,00	1	004150178
20,00	210	140	209,00	1	004150180



Co8%

415/SP19	€	Hand	Machine
Ø 1÷10 x 0,5 mm	205,00	1	004150419
410/SPVP1	29,00	1	004100421
415/SP25	425,00	1	004150425
Ø 1÷13 x 0,5 mm			
410/SPVP2	39,00	1	004100427
415/SP49	1.099,00	1	004150431
Ø 1÷13 x 0,25 mm			
415/SPV4	125,00	1	004150432

415/C116



415/C116 € 940,00 1 004150450

415	Ø 1 - 1,5 - 2 - 2,5 - 3 - 3,5 - 4 - 4,5 - 5 mm	n.
	Ø 5,5 - 6 - 6,5 - 7 - 7,5 - 8 mm	3
	Ø 8,5 - 9 - 9,5 - 10 mm	2

365x230x47 mm - 2,7 kg



415/SP91 € 1.275,00 1 004150460
Ø 1÷10 x 0,10 mm

415CO

Spiraalboren met ronde schacht, korte uitvoering, HSS-CO 5%, volledig geslepen

R ≤ 1200 N/mm²
HV ~ 800+860



Co5%

DIN 338 ISO 235

Ø mm	L mm	L1 mm	€	Hand	Machine
1,00	34	12	1,92	10	004150310
1,50	40	18	1,92	10	004150312
2,00	49	24	1,92	10	004150314
2,50	57	30	1,98	10	004150316
3,00	61	33	1,98	10	004150320
3,50	70	39	2,37	10	004150322
4,00	75	43	2,82	10	004150324
4,50	80	47	3,25	10	004150326
5,00	86	52	3,35	10	004150328
5,50	93	57	4,15	10	004150330
6,00	93	57	4,75	10	004150332
6,50	101	63	5,55	10	004150334
7,00	109	69	6,80	10	004150336
7,50	109	69	7,65	5	004150338
8,00	117	75	8,90	5	004150340
8,50	117	75	9,40	5	004150342
9,00	125	81	11,40	5	004150344
9,50	125	81	12,20	5	004150346
10,00	133	87	13,90	5	004150348
10,50	133	87	17,10	5	004150350
11,00	142	94	18,60	5	004150352
11,50	142	94	20,40	5	004150354
12,00	151	101	22,20	5	004150356
12,50	151	101	25,00	5	004150358
13,00	151	101	26,50	5	004150360

415CO-A

Spiraalboren met ronde schacht, korte uitvoering, HSS-CO 5%, volledig geslepen

R ≤ 1200 N/mm²
HV ~ 800+860



Co5%

DIN 338

Ø mm	L mm	L1 mm	€	Hand	Machine
14,00	160	108	52,00	3	004150364
15,00	169	114	60,00	3	004150366
16,00	178	120	72,50	3	004150368
17,00	184	125	74,50	1	004150370
18,00	191	130	95,50	1	004150372
19,00	198	135	110,50	1	004150374
20,00	205	140	126,00	1	004150376



Co5%

DIN 338

415CO/SP19	€	Hand	Machine
Ø 1÷10 x 0,5 mm	99,00	1	004150421
410/SPVP1	29,00	1	004100421

415L

Spiraalboren, lange uitvoering, HSS-CO 5%, volledig geslepen

R ≤ 1200 N/mm²
HV ~ 800+860



DIN 340

Ø mm	L mm	L1 mm	€	🔧	🚚
3,00	100	66	5,15	10	004150236
3,50	112	73	5,55	10	004150238
4,00	119	78	6,95	10	004150240
4,50	126	82	8,65	10	004150242
5,00	132	87	8,80	10	004150244
5,50	139	91	11,00	10	004150246
6,00	139	91	12,20	10	004150248
6,50	148	97	14,10	5	004150250
7,00	156	102	17,10	5	004150252
8,00	165	109	21,50	5	004150256
9,00	175	115	26,50	5	004150260
10,00	184	121	34,50	5	004150264

416

Cylindrische boren, speciaal geslepen met dubbele penetratiekegel

R ≤ 900 N/mm²
HV ~ 820+850



DIN 338

Ø mm	L mm	L1 mm	€	🔧	🚚
1,00	34	12	3,15	10	004160010
1,50	40	18	3,15	10	004160015
2,00	49	24	3,15	10	004160020
2,50	57	30	3,30	10	004160025
3,00	61	33	3,55	10	004160030
3,50	70	39	3,90	10	004160035
4,00	75	43	4,35	10	004160040
4,50	80	47	4,60	10	004160045
5,00	86	52	5,40	10	004160050
5,50	93	57	6,95	10	004160055
6,00	93	57	7,45	10	004160060
6,50	101	63	8,85	10	004160065
7,00	109	69	10,30	10	004160070
7,50	109	69	11,20	5	004160075
8,00	117	75	13,40	5	004160080
8,50	117	75	14,70	5	004160085
9,00	125	81	16,90	5	004160090
9,50	125	81	18,30	5	004160095
10,00	133	87	20,80	5	004160100



Product	€	🔧	🚚
416/SP19 Ø 1÷10 x 0,5 mm	145,00	1	004160419
410/SPVP1	29,00	1	004100421

416P/SP19

Set van 19 spiraalboren met cilindrische schacht, gemaakt van HSS, AISI M2, volledig geslepen, met kleinere boor voor zeer nauwkeurig centreren en sneller boren

Ø 1÷10 x 0,5 mm
HOGERE BOORSNELHEID
R ≤ 900 N/mm²
HV ~ 820+850

HOGERE BOORCAPACITEIT



Product	€	🔧	🚚
416P/SP19 Ø 1÷10 x 0,5 mm	155,00	1	004160469

115x170x40 mm

417

Steenboren, korte uitvoering vervaardigd uit gefreesd staal met hardmetalen snijplaten



DIN 8039

Ø mm	L mm	€	🔧	🚚
3	70	4,05	10	004170003
4	75	4,20	10	004170004
5	85	4,35	10	004170005
5L	150	9,80	5	004170105
6	100	4,35	10	004170007
6L	150	9,80	5	004170106
7	120	5,15	10	004170009
8	120	5,70	10	004170010
8L	200	10,40	5	004170113
9	120	6,30	10	004170011
10	120	7,55	10	004170012
10L	200	12,60	5	004170120
12	150	9,70	10	004170014
12L	200	13,90	5	004170125
14	150	13,50	5	004170016
16	150	16,50	5	004170018



Product	€	🔧	🚚
417/SP8 Ø 3-4-5-6-8-9-10-12 mm	59,00	1	004170100

419

Hamerboren met SDS plus aansluiting gefreesde schacht en hard metalen snijplaten
HVA ~ 1650



Ø mm	L mm	€	🔧	🚚
4	110	8,75	10	004190002
5	110	8,90	10	004190004
5	160	9,40	10	004190006
6	110	8,65	10	004190012
6	160	8,95	10	004190014
6	210	12,40	10	004190016
7	160	10,30	10	004190028
8	110	9,35	10	004190030
8	160	9,55	10	004190032
8	210	11,80	10	004190034
8	260	16,00	10	004190036
8	310	18,20	10	004190038
8	460	36,00	10	004190042
9	160	12,00	5	004190044
10	160	12,30	5	004190050
10	210	14,30	5	004190052
10	260	17,50	5	004190054
10	310	24,60	5	004190056
10	460	39,50	5	004190060
12	160	13,90	5	004190064
12	210	18,60	5	004190066
12	260	20,40	5	004190068
12	460	42,50	5	004190074
14	160	18,50	3	004190086
14	260	22,20	3	004190090
14	310	31,50	3	004190092
14	460	42,50	3	004190096
16	210	27,00	3	004190112
16	260	29,00	3	004190114
16	310	35,00	3	004190116
16	460	46,50	3	004190120
18	260	37,00	1	004190124
20	310	37,00	1	004190128



Product	€	🔧	🚚
419/SP7 Ø 5 - 6 - 8 x 110 mm Ø 6 - 8 - 10 - 12 x 160 mm	72,00	1	004190507



419T

Hamerboren met SDS plus aansluiting
4 spiraal en 4 snijvlakken

HVA~ 1650

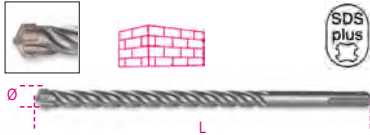

Ø mm	L mm	€		
5	110	5,25	5	004190604
5	160	5,85	5	004190606
6	110	5,55	5	004190612
6	160	6,55	5	004190614
6	210	8,75	5	004190616
7	160	6,50	5	004190628
8	110	5,95	5	004190630
8	160	6,80	5	004190632
8	210	9,05	5	004190634
8	260	10,30	5	004190636
8	310	12,70	5	004190638
9	160	7,35	3	004190644
10	160	7,25	3	004190650
10	210	9,70	3	004190652
10	260	10,50	3	004190654
10	310	15,00	3	004190656
10	460	20,40	3	004190660
12	160	8,05	3	004190664
12	210	10,70	3	004190666
12	260	11,30	3	004190668
12	460	21,00	3	004190674
14	160	11,00	2	004190686
14	260	12,70	2	004190690
14	310	18,20	2	004190692
14	460	20,40	2	004190696
16	210	15,00	2	004190712
16	260	19,50	2	004190714
16	310	21,00	2	004190716
16	460	21,70	2	004190720
18	260	23,70	1	004190724
20	310	28,00	1	004190728

421

Verzinkboren met geleiderpin,
fijne spoed,
vervaardigd uit HSS

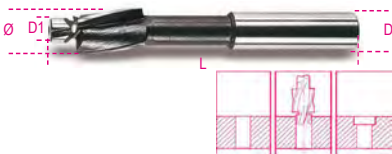

DIN 373

M	L mm	Ø mm	D1 mm	D mm	€		
3	71	6	3,2	5	30,50	1	004210003
4	71	8	4,3	5	30,50	1	004210004
5	80	10	5,3	8	30,50	1	004210005
6	80	11	6,4	8	32,00	1	004210006
8	100	15	8,4	12,5	50,50	1	004210008
10	100	18	10,5	12,5	59,50	1	004210010
12	100	20	13,0	12,5	65,50	1	004210012



	€		
421/SP6	249,00	1	004210019
M 3-4-5-6-8-10			
421/SPV	19,20	1	004210020

422

Geslepen centreerboren,
60°
verzinkhoek,
vervaardigd uit HSS

• Voor snel en veilig boren van centreer gaten



DIN 333/A

Ø mm	D mm	L mm	€		
1,60	4,0	35,5	9,20	1	004220116
2,50	6,3	45,0	10,40	1	004220125
3,15	8,0	50,0	11,90	1	004220131

423

Puntlasboor HSS geslepen



Ø mm	L mm	€		
6	66	19,10	5	004230006
7	74	23,70	5	004230007
8	79	25,50	5	004230008
10	89	30,00	5	004230010

423A

Speciaal frees voor puntlassen,
met centreerpunt HSS geslepen



DIN 1412/E

Ø mm	L mm	€		
6,5	40	27,00	1	004230015
8,0	40	30,00	1	004230020

424

Conische frees HSS

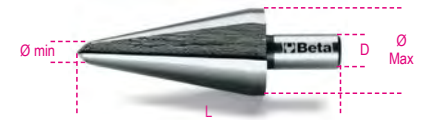

L mm	Ø mm	D mm	€		
424/1	58	3÷14	6	35,00	2 004240001
424/2	63	6÷20	8	58,00	2 004240002
424/3	60	16÷30	10	102,50	2 004240003
424/4	80	3÷22	8	124,50	1 004240004
424/5	102	3÷31	10	170,50	1 004240005
424/6	86	26÷40	13	213,00	1 004240006
424/7	89	36÷50	13	317,00	1 004240007
424/8	90	40÷61	13	523,00	1 004240008



	€		
424/SP3	199,00	1	004240019
424/1+424/2+424/3			
Ø 3÷30 mm			
424/SPV	27,50	1	004240020

425

Trapboren HSS

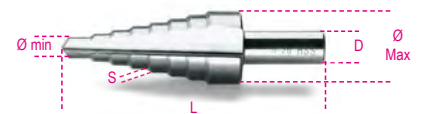

L mm	Ø mm	S mm	D mm	€		
425/1	70	4÷12	1 6	58,00	2	004250010
425/2	55	4÷12	2 6	59,50	2	004250012
425/3	85	4÷20	2 10	92,00	2	004250015
425/4	85	12÷20	1 10	131,50	1	004250016
425/5	97	20÷30	1 10	263,00	1	004250017
425/6	75	4÷30	2 10	191,00	1	004250020
425/7	97	30÷40	1 13	376,00	1	004250025
425/8	100	40÷50	1 13	524,00	1	004250029



	€		
425/SP3	329,00	1	004250030
425/1+425/3+425/6			
Ø 4÷30 mm			
425/SPV	30,00	1	004250035

426

Verzinkfrezen
met drie snijkanten,
HSS



DIN 335-C

GR	Ø mm	L mm	Ø1 mm	€		
1	4,3	44	4	19,70	3	004260001
2	5,3	44	4	19,70	3	004260002
3	6,3	44	5	20,40	3	004260003
4	7,3	44	6	23,60	3	004260004
5	8,3	50	6	23,60	3	004260005
6	9,4	50	6	26,00	3	004260006
7	10,4	54	6	30,00	3	004260007
8	12,4	54	8	32,50	3	004260008
9	15,0	56	10	36,00	3	004260009
10	16,5	60	10	38,50	3	004260010
11	20,5	63	10	53,50	3	004260011
12	25,0	66	10	83,00	3	004260012
13	28,0	71	12	112,00	3	004260013
14	31,0	71	12	117,50	3	004260014



DIN 335-C

	€		
426/SP6	199,00	1	004260030
GR 3-5-7-8-10-11			
Ø 6,3÷20,5 mm			
426/SPV	28,00	1	004260035

426A/SP6

set van 6 verzinkfrezen,
met drie asymmetrische spiraalmessen,
gemaakt van HSS

Ø 6.3 - 8.3 - 10.4 - 12.4 - 16.5 - 20.5 mm



	€		
426A/SP6	215,00	1	004260060
Ø 6,3-8,3-10,4-12,4-16,5-20,5 mm			
100x145x40 mm			

426T

Conische verzink frezen
met drie snijkanten,
HSS + TiN



DIN 335-C

GR	Ø mm	L mm	Ø1 mm	€		
1	4,3	44	4	24,40	3	004260061
2	5,3	44	4	24,40	3	004260062
3	6,3	44	5	24,90	3	004260063
4	7,3	44	6	27,50	3	004260064
5	8,3	50	6	27,50	3	004260065
6	9,4	50	6	30,00	3	004260066
7	10,4	54	6	34,50	3	004260067
8	12,4	54	8	36,00	3	004260068
9	15,0	56	10	40,50	3	004260069
10	16,5	60	10	45,00	3	004260070
11	20,5	63	10	58,00	3	004260071
12	25,0	66	10	89,00	3	004260072
13	28,0	71	12	112,00	3	004260073
14	31,0	71	12	119,50	3	004260074



DIN 335-C

	€		
426T/SP6	225,00	1	004260080
GR 3-5-7-8-10-11			
Ø 6,3÷20,5 mm			
426/SPV	28,00	1	004260035

426SB

Conische frezen HSS



GR	Ø mm	D mm	L mm	€			
426/SB1	1	2÷5	6	45	27,00	1	004260101
426/SB2	2	5÷10	8	48	32,50	1	004260102
426/SB3	3	10÷15	10	65	58,50	1	004260103
426/SB4	4	15÷20	12	85	113,00	1	004260104
426/SB5	5	20÷25	15	102	189,50	1	004260105
426/SB6	6	25÷30	15	115	329,00	1	004260106



	€		
426SB/SP4	269,00	1	004260130
426/SB1-426/SB2			
426/SB3-426/SB4			
Ø 2÷20 mm			
426SB/SPV1	29,00	1	004260135

426MD-3/CP3

Mini hardmetalen frezen

• Gladde vertanding met spaanbreker



L mm	Ø mm	€		
38,1	3	13,60	1	004260332

426MD-3/CT3

Mini hardmetalen frezen

• Gladde vertanding met spaanbreker



L mm	Ø mm	€		
37,8	3	13,60	1	004260333

426MD-3/F3

Mini hardmetalen frezen

• Gladde vertanding met spaanbreker



L mm	Ø mm	€		
38,3	3	13,60	1	004260334

426MD-3/FA3

Mini hardmetalen frezen

• Gladde vertanding met spaanbreker



L mm	Ø mm	€		
38,2	3	13,60	1	004260339

426MD-3/OG3

Mini hardmetalen frezen

• Gladde vertanding met spaanbreker



L mm	Ø mm	€		
38,1	3	13,60	1	004260337

426MD-3/OV3

Mini hardmetalen frezen

- Gladde vertanding met spaanbreker



L mm	Ø mm	€	🔧	📄
38,2	3	13,60	1	004260331

426MD-3/S3

Mini hardmetalen frezen

- Gladde vertanding met spaanbreker



L mm	Ø mm	€	🔧	📄
38,0	3	13,60	1	004260338

426MD-3/T3

Mini hardmetalen frezen

- Gladde vertanding met spaanbreker



L mm	Ø mm	€	🔧	📄
38,3	3	13,60	1	004260336

426MD-3/TA3

Mini hardmetalen frezen

- Gladde vertanding met spaanbreker



L mm	Ø mm	€	🔧	📄
38,3	3	13,60	1	004260335



€	🔧	📄
122,50	1	004260349

426MD-3/A9
426MD-3/OV3 - 426MD-3/CP3
426MD-3/CT3 - 426MD-3/F3
426MD-3/TA3 - 426MD-3/T3
426MD-3/OG3 - 426MD-3/S3
426MD-3/FA3

426MD/CP

Hardmetalen frezen

kruissnede HM4



L mm	Ø mm	€	🔧	📄
50	6	38,50	1	004260532
63	8	44,00	1	004260512
63	9,5	49,00	1	004260542
69	12	70,50	1	004260522
69	16	97,00	1	004260552

426MD/CT

Hardmetalen frezen

kruissnede HM4



L mm	Ø mm	€	🔧	📄
50	6	38,50	1	004260533
63	8	44,00	1	004260513
63	9,5	49,00	1	004260543
69	12	70,50	1	004260523
69	16	95,00	1	004260553

426MD/F

Hardmetalen frezen

kruissnede HM4



L mm	Ø mm	€	🔧	📄
50	6	38,50	1	004260534
63	8	44,00	1	004260514
63	9,5	49,00	1	004260544
69	12	70,50	1	004260524
69	16	76,00	1	004260554

426MD/FA

Hardmetalen frezen

kruissnede HM4



L mm	Ø mm	€	🔧	📄
50	6	38,50	1	004260539
63	8	44,00	1	004260519
63	9,5	49,00	1	004260549
69	12	70,50	1	004260529
69	16	89,00	1	004260559

426MD/OG

Hardmetalen frezen

kruissnede HM4



L mm	Ø mm	€	🔧	📄
50	6	38,50	1	004260537
63	8	44,00	1	004260517
70	10	49,00	1	004260547
76	12	70,50	1	004260527
81	16	98,50	1	004260557

426MD/OV

Hardmetalen frezen

kruissnede HM4



L mm	Ø mm	€	🔧	📄
50	6	38,50	1	004260531
61	9,5	49,00	1	004260541
67	12	70,50	1	004260521
69	16	89,00	1	004260551

426MD/S

Hardmetalen frezen

kruissnede HM4



L mm	Ø mm	€	🔧	📄
50	6	38,50	1	004260538
51	8	44,00	1	004260518
53	9,5	49,00	1	004260548
56	12	70,50	1	004260528
59	16	76,00	1	004260558

426MD/T

Hardmetalen frezen

kruissnede HM4



L mm	Ø mm	€	🔧	📄
50	6	38,50	1	004260535
63	8	44,00	1	004260515
63	9,5	49,00	1	004260545
69	12	70,50	1	004260525
70	16	76,00	1	004260555

426MD/TA

Hardmetalen frezen

kruissnede HM4



L mm	Ø mm	€	🔧	📄
50	6	38,50	1	004260535
67	8	44,00	1	004260515
72	9,5	49,00	1	004260545
73	12	70,50	1	004260525
78	16	97,00	1	004260555



€	🔧	📄
475,00	1	004260510

426MD/SP10
426MD/CP-426MD/CT-426MD/F
426MD/T-426MD/S
Ø 8-12 mm

427

Conusdoorslag gehard en geslepen staallegering



DIN 317

GR	L mm	A mm	€	1	004270000
0	92	13	13,30	3	004270000
1-2	140	19	19,40	3	004270002
3	190	25	23,20	3	004270003
4	225	30	39,00	3	004270004
5-6	260	35	71,50	3	004270006

428FP

Machinetappen voor doorlopende gaten HSS



ISO 529

M	mm	L mm	L1 mm	€	10	004280003
3x0,5	2,7	56	11	19,70	10	004280003
4x0,7	3,4	63	13	19,70	10	004280004
5x0,8	4,9	70	16	19,70	10	004280005
6x1	4,9	80	19	21,00	10	004280006
8x1,25	6,2	90	22	25,00	10	004280008
10x1,5	8,0	100	24	29,00	10	004280010
12x1,75	9,0	110	29	38,00	5	004280012
14x2	7,0	110	30	47,50	5	004280014
16x2	9,0	110	30	56,50	5	004280016
18x2,5	11,0	125	34	74,00	3	004280018
20x2,5	12,0	140	34	82,50	3	004280020
22x2,5	14,5	140	34	99,00	3	004280022
24x3	14,5	160	38	106,50	3	004280024

428FC

Machinetappen voor blinde gaten HSS



ISO 529

M	mm	L mm	L1 mm	€	10	004280103
3x0,5	2,7	56	11	23,50	10	004280103
4x0,7	3,4	63	13	23,50	10	004280104
5x0,8	4,9	70	16	23,50	10	004280105
6x1	4,9	80	19	24,60	10	004280106
8x1,25	6,2	90	22	27,00	10	004280108
10x1,5	8,0	100	24	32,00	10	004280110
12x1,75	9,0	110	29	41,50	5	004280112
14x2	7,0	110	30	54,50	5	004280114
16x2	9,0	110	30	64,00	5	004280116
18x2,5	11,0	125	34	86,00	3	004280118
20x2,5	12,0	140	34	92,00	3	004280120
22x2,5	14,5	140	34	111,50	3	004280122
24x3	14,5	160	38	117,50	3	004280124

428/C14

14-delig assortiment machinetappen 428FP+428FC



428/C14	€	1	004280201
428FP M3÷12	439,00	1	004280201
428FC M3÷12			
428/SPV	24,40	1	004280202

429FP

Machinetappen voor doorlopende gaten HSS-CO 5%



ISO 529

M	mm	L mm	L1 mm	€	5	004290003
3x0,5	2,7	56	11	25,50	5	004290003
4x0,7	3,4	63	13	25,50	5	004290004
5x0,8	4,9	70	16	25,50	5	004290005
6x1	4,9	80	19	27,00	5	004290006
8x1,25	6,2	90	22	30,50	5	004290008
10x1,5	8,0	100	24	37,00	5	004290010
12x1,75	9,0	110	29	46,00	5	004290012
14x2	9,0	110	30	59,00	5	004290014

429FC

Machinetappen voor blinde gaten HSS-CO 5%



ISO 529

M	mm	L mm	L1 mm	€	5	004290103
3x0,5	2,7	56	11	31,00	5	004290103
4x0,7	3,4	63	13	31,00	5	004290104
5x0,8	4,9	70	16	31,00	5	004290105
6x1	4,9	80	19	33,00	5	004290106
8x1,25	6,2	90	22	37,50	5	004290108
10x1,5	8,0	100	24	45,50	5	004290110
12x1,75	9,0	110	29	54,50	5	004290112
14x2	9,0	110	30	71,50	5	004290114

429/C14

14-delig assortiment machinetappen 429FP+429FC



429/C14	€	1	004290201
429FP M3÷12	475,00	1	004290201
429FC M3÷12			
428/SPV	24,40	1	004280202

430

Handtappen, grove spoed, metrische draad verchromd staal

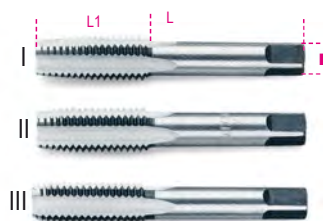

DIN 352 UNI 4535

M	mm	L mm	L1 mm	€	5	004300002
2x0,4	2,5	36	11	17,10	5	004300002
3x0,5	2,5	40	12	12,30	5	004300003
4x0,7	3,0	45	14	12,30	5	004300004
5x0,8	4,0	48	16	12,80	5	004300005
6x1	5,0	50	18	12,80	5	004300006
7x1	4,5	50	18	16,30	5	004300007
8x1,25	5,0	56	22	16,50	3	004300008
9x1,25	5,5	63	22	22,70	3	004300009
10x1,5	6,0	70	25	21,80	3	004300010
11x1,5	7,0	70	25	27,50	3	004300011
12x1,75	7,0	75	30	27,50	3	004300012
14x2	8,0	80	32	33,50	3	004300014
16x2	10,0	80	32	39,50	3	004300016
18x2,5	11,0	95	40	53,50	1	004300018
20x2,5	12,0	95	40	65,50	1	004300020
22x2,5	14,5	100	40	78,00	1	004300022
24x3	14,5	110	50	91,50	1	004300024



430/SP21	€	1	004300201
M 3-4-5-6-8-10-12	147,50	1	004300201
430/SPV	28,00	1	004300202

430ASW

Handtappen, Whitworth draad
verchroomd staal



DIN 352

BSW	mm	L	L1	€		
1/8x40	2,7	40	12	11,80	5	004300031
5/32x32	3,4	45	14	11,80	5	004300032
3/16x24	4,3	48	18	11,80	5	004300033
1/4x20	4,9	50	22	13,90	5	004300034
5/16x18	4,9	56	25	17,00	3	004300035
3/8x16	5,5	70	28	21,70	3	004300036
7/16x14	6,2	70	30	24,40	3	004300037
1/2x12	7,0	75	32	27,00	3	004300038
9/16x12	9,0	80	32	33,00	1	004300039
5/8x11	9,0	80	38	39,00	1	004300040
3/4x10	11,0	95	40	57,00	1	004300041
7/8x9	14,5	100	40	71,50	1	004300042
1"x8	16,0	110	50	93,50	1	004300043

430ASC

Handtappen, UNC draad
verchroomd staal



ANSI B1.1

UNC	mm	L	L1	€		
1/4x20	4,9	70	30	17,50	5	004300051
5/16x18	4,9	70	30	22,50	5	004300052
3/8x16	5,5	75	35	25,00	3	004300053
7/16x14	6,2	80	40	32,50	3	004300054
1/2x13	7,0	85	45	41,00	3	004300055
9/16x12	9,0	90	45	52,50	3	004300056
5/8x11	9,0	100	47	58,50	3	004300057
3/4x10	11,0	110	50	78,50	3	004300058
7/8x9	14,5	120	60	91,50	1	004300059
1"x8	16,0	130	60	103,50	1	004300060

431

Handtappen, grove spoed,
metrische draad HSS



DIN 352 UNI 4535

M	mm	L	L1	€		
3x0,5	2,5	40	12	23,10	5	004310003
4x0,7	3,0	45	14	23,10	5	004310004
5x0,8	4,0	48	16	24,90	5	004310005
6x1	5,0	50	18	24,90	5	004310006
7x1	5,0	50	18	31,50	5	004310007

M	mm	L	L1	€		
8x1,25	5,0	56	22	28,00	3	004310008
10x1,5	6,0	70	25	35,50	3	004310010
12x1,75	7,0	75	30	51,50	3	004310012
14x2	9,0	80	32	70,00	1	004310014
16x2	9,0	80	32	81,50	1	004310016
18x2,5	11,0	95	40	122,00	1	004310018
20x2,5	12,0	95	40	131,00	1	004310020
22x2,5	12,0	100	40	191,00	1	004310022
24x3	14,5	110	50	207,00	1	004310024



	€		
431/SP21	241,00	1	004310201
M 3-4-5-6-8-10-12			
431/SPV	28,00	1	004310202

433

Handtappen, fijne spoed, metrische draad
verchroomd staal



DIN 2181 UNI 4535

M	mm	L	L1	€		
6x0,75	4,5	48	16	10,80	5	004330201
7x0,75	4,5	56	18	13,30	5	004330202
8x0,75	5,0	50	16	13,30	5	004330203
8x1	5,0	56	16	13,30	5	004330204
9x0,75	6,0	63	22	17,10	5	004330205
9x1	6,0	63	22	17,10	5	004330206
10x0,75	6,5	63	18	17,10	5	004330207
10x1	6,5	63	18	17,10	5	004330208
10x1,25	6,5	63	18	17,10	5	004330209
11x0,75	7,0	70	25	23,10	3	004330210
11x1	7,0	70	25	23,10	3	004330211
11x1,25	7,0	70	25	23,10	3	004330212
12x0,75	7,0	70	20	22,50	3	004330213
12x1	7,0	70	20	22,50	3	004330214
12x1,25	7,0	70	20	22,50	3	004330215
12x1,5	7,0	70	20	22,50	3	004330216
14x1	8,0	80	32	29,00	1	004330217
14x1,25	8,0	80	32	29,00	1	004330218
14x1,5	8,0	80	32	29,00	1	004330219
16x1	10,0	80	32	34,00	1	004330220
16x1,5	10,0	80	32	34,00	1	004330221
18x1,5	11,0	95	40	41,50	1	004330222
18x2	11,0	80	25	53,50	1	004330223
20x1,5	14,5	80	22	60,50	1	004330224
22x1,5	14,5	80	22	72,50	1	004330225
24x1,5	14,5	80	22	84,00	1	004330226
24x2	14,5	80	22	84,00	1	004330227

433ASF

Handtappen, fijne spoed, UNF draad
verchroomd staal



ANSI B1.1

UNF	mm	L	L1	€		
1/4x28	4,9	70	30	13,50	5	004330301
5/16x24	4,9	70	30	16,00	5	004330302
3/8x24	5,5	75	35	18,00	3	004330303
7/16x20	6,2	80	40	22,70	3	004330304
1/2x20	7,0	85	45	28,00	3	004330305
9/16x18	9,0	90	45	35,00	3	004330306
5/8x18	9,0	100	47	39,50	3	004330307
3/4x16	11,0	110	50	54,00	3	004330308
7/8x14	14,5	120	60	70,00	1	004330309
1"x12	16,0	130	60	97,00	1	004330310

433ASG

Handtappen, cilindrisch GAS-draad
verchroomd staal



DIN 5157

GAS	mm	L	L1	€		
1/8x28	5,5	65	18	18,70	1	004330401
1/4x19	9,0	70	24	23,60	1	004330402
3/8x19	9,0	75	25	28,00	1	004330403
1/2x14	12,0	80	31	42,00	1	004330405
3/4x14	16,0	90	33	67,00	1	004330408
1"x11	20,0	100	39	108,00	1	004330410

434

Handtappen, fijne spoed,
metrische draad HSS

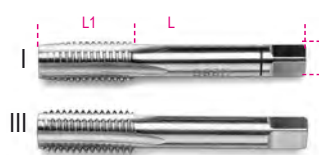

DIN 2181 UNI 4535

M	mm	L	L1	€		
6x0,75	4,5	48	16	30,00	5	004340001
8x0,75	5,0	56	16	33,00	5	004340003
8x1	5,0	56	16	33,00	5	004340004
10x0,75	6,5	63	18	42,00	5	004340007
10x1	6,5	63	18	42,00	5	004340008
10x1,25	6,5	63	18	42,00	5	004340009
12x1	7,0	70	20	46,00	3	004340014
12x1,25	7,0	70	20	46,00	3	004340015
12x1,5	7,0	70	20	46,00	3	004340016
13x1,5	9,0	70	20	91,00	1	004340017
14x1	9,0	70	20	56,50	1	004340018
14x1,25	9,0	70	20	56,50	1	004340019
14x1,5	9,0	70	20	50,50	1	004340020
15x1,5	9,0	70	20	91,00	1	004340021
16x1	9,0	70	20	60,50	1	004340022
16x1,5	9,0	70	20	53,50	1	004340023
18x1,5	11,0	80	22	68,50	1	004340024
18x2	11,0	90	25	83,00	1	004340025
20x1,25	12,0	80	22	123,00	1	004340026
20x1,5	12,0	80	22	73,00	1	004340027
20x2	12,0	90	25	93,00	1	004340028
22x1,5	14,5	80	22	106,00	1	004340029
24x1	14,5	80	22	144,00	1	004340030
24x1,5	14,5	80	22	119,00	1	004340031
24x2	14,5	80	22	125,00	1	004340032

Beta
Quality Tools

435

Verstelbaar wringijzer hamerslag stalen huis



DIN 1814

	□ mm	L mm	€		
435/0	2÷5 M1÷M8	170	20,20	3	004350007
435/1	2÷6 M1÷M10	200	23,60	2	004350009
435/1,5	2,5÷6 M1÷M12	200	24,60	2	004350011
435/2	3÷7 M4÷M12	260	36,00	2	004350013
435/3	4÷12 M5÷M20	345	60,50	1	004350020
435/4	5,5÷16 M9÷M27	430	93,00	1	004350027
435/5	7÷18 M13÷M32	770	211,50	1	004350032

435G

Verstelbaar wringijzer hamerslag gietstalen huis



DIN 1814

	□ mm	L mm	€		
435G/0	2÷5 M1÷M8	130	14,30	5	004350108
435G/1	2÷6 M1÷M10	190	17,80	5	004350110
435G/1,5	2÷7 M2÷M12	175	18,40	5	004350112
435G/2	3,4÷7 M4÷M12	280	30,50	5	004350114
435G/3	4,9÷12 M5÷M20	380	49,00	2	004350121
435G/4	7÷16 M11÷M27	500	77,00	2	004350127
435G/5	7÷18 M13÷M32	700	121,50	1	004350132
435G/6	11÷24 M18÷M42	800	200,50	1	004350142

436

Taphouder met ratel

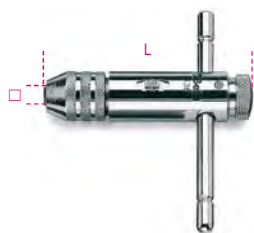

	□ mm	L mm	€		
436/1	2÷5 M3÷M8	85	33,00	5	004360002
436/2	4,6÷8 M5÷M12	110	42,50	5	004360004

436L

Taphouder met ratel, lange uitvoering



	□ mm	L mm	€		
436L/1	2÷5 M3÷M8	245	53,00	2	004360012
436L/2	4,6÷8 M5÷M12	295	61,50	2	004360014

436R

Reserve bekken voor artikel 436 en 436L

	€		
436R/1	6,45	1	004360022
436R/2	7,00	1	004360024

437P

Draadvijs, voor het repareren van binnen en buitendraad, linkse en rechtse draad

P 0.80±3.00 mm



L mm	€		
230	53,50	1	004370003

437C

Set voor het herstellen van beschadigde draad van bougies, M14x1.25 mm

• Helicoids hoogte: 8.40 - 12.40 - 16.40 mm (5 stuks per maat)



437C	€		
	133,00	1	004370100

437C/...

Roestvaststalen helicoids voor item 437C



H mm	€		
8.4	34,00	1	004370108
12.4	34,00	1	004370112
16.4	34,00	1	004370116

De afgebeelde prijzen zijn per 10 stuks

437C/RM14

Helicoids voor bougieschroefdraad. M14x1.25



437C/RM14	€		
	117,00	1	004370124

437K/8

Gereedschapset voor het herstellen van schroefdraad aan aandrijfassen

• Maakt het mogelijk het schroefdraad te herstellen in oorspronkelijk staat.

Set bevat:

• Metrische maten:

20x1.25 - 20x1.5 - 22x1.00 - 22x1.5 - 24x1.5 - 24x2.00

• Inch maten:

3/4x20 - 13/16x20



○ 32 mm

437K/8	€		
	89,00	1	004370020

≡ 200x110x30 mm

437K/9

Gereedschap voor het herstellen van zowel inwendige als uitwendige schroefdraad bij wielbouten

Maakt het mogelijk de originele draad te corrigeren en opnieuw op te bouwen

Set bevat:

• Tappen:

M12x1.25 - M12x1.5 - M12x1.75 - M14x1.5

• Snijplaten:

M12x1.25 - M12x1.5 - M14x1.5



○ 12 - 24 mm

437K/9	€		
	99,00	1	004370029

≡ 161x123x50 mm

437K/12

Gereedschap voor het herstellen van schroefdraad bij aandrijfassen

Maakt het mogelijk sw originele draad te corrigeren en opnieuw op te bouwen

Set bevat:

• Metrische maten:

M16x1.0 - M16x1.5 - M20x1.0 - M20x1.5 - M22x1.5 - M24x1.5 - M24x2.0 - M27x2.0

• Inch maten:

3/4x16 - 3/4x20 - 13/16x20 - 27/32x20



○ 32 - 35 mm

437K/12 € 118,00 1 004370032

≡ 220x118x52 mm

437K/16

Gereedschap assortiment voor het herstellen van beschadigde draad op remklauwen M9x1.25



437K/16 € 125,00 1 004370016

≡ 210x150x50 mm

437K/33

Gereedschap assortiment voor het herstellen van beschadigde draad van bougies

Bussen:

M8x1.0 - M10x1.0 - M10x1.25 - M12x1.25

Tappen:

M8x1.0 - M10x1.0 - M10x1.25 - M12x1.0 - M12x1.25 - M14x1.25



437K/33 € 310,00 1 004370133

≡ 210x150x50 mm

437U/09



25 x M5, M6, M8, M10
10 x M12

437U/09 € 396,00 1 004370550

M5X0,8
M6X1,0
M8X1,25
M10X1,5
M12X1,75

≡ 370x230x55 mm - 2 Kg

437U/E-M...

Roestvast stalen helicoils



	H mm	€		
M5	7,5	20,30	1	004370555
M6	9	20,30	1	004370556
M8	12	27,50	1	004370558
M10	15	37,00	1	004370560
M12	18	24,90	1	004370562

Prijzen zijn voor 25 stuks (10 voor M12)

437U/PM

Bits en tappen voor item 437U/09



	€		
M5	38,00	1	004370565
M6	39,50	1	004370566
M8	53,50	1	004370568
M10	70,50	1	004370570
M12	88,00	1	004370572

438A

7-delig set voor het boren, tappen en verzinken; HSS

- M3 - M4 - M5 - M6 - M8 - M10
- Met magnetische taphouder



± S MAX mm = Ø mm

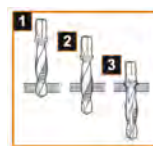

438A € 136,00 1 004380010

438...

Bits voor boren, tappen en verzinken

HSS, 1/4" aansluiting

1/4



	S max mm	€		
M3	3	25,00	2	004380103
M4	4	25,00	2	004380104
M5	5	25,00	2	004380105
M6	6	25,00	2	004380106
M8	8	29,00	2	004380108
M10	10	29,00	2	004380110

440

Snijplaten, grove spoed, metrische draad, verchroomd staal

R ≤ 600 N/mm²
HRC || 60+61



UNI 4535
DIN 223

M	Ø x S mm	€		
2x0,4	25,4 x 9	21,00	5	004400002
3x0,5	25,4 x 9	15,40	5	004400003
4x0,7	25,4 x 9	15,40	5	004400004
5x0,8	25,4 x 9	13,20	5	004400005
6x1	25,4 x 9	13,20	5	004400006
7x1	25,4 x 9	13,20	5	004400007
8x1,25	25,4 x 9	13,20	5	004400008
9x1,25	25,4 x 9	13,20	5	004400009
10x1,5	25,4 x 9	13,20	5	004400010
12x1,75	25,4 x 9	13,20	5	004400012

440A

Snijplaten, grove spoed, metrische draad, verchroomd staal

R ≤ 600 N/mm²
HRC || 60+61



UNI 4535
DIN 223

M	Ø x S mm	€		
10x1,5	38,1 x 14	18,70	3	004400110
11x1,5	38,1 x 14	18,70	3	004400111
12x1,75	38,1 x 14	18,70	3	004400112
14x2	38,1 x 14	18,70	3	004400114
16x2	38,1 x 14	18,70	3	004400116
18x2,5	38,1 x 14	21,60	3	004400118
20x2,5	38,1 x 14	24,00	3	004400120

440B

Snijplaten, grove spoed, metrische draad, verchromd staal

R ≤ 600 N/mm²
HRC || 60÷61



UNI 4535
DIN 223

M	Ø x S mm	€		
18x2,5	50,8 x 16	33,50	3	004400122
20x2,5	50,8 x 16	34,50	3	004400124
22x2,5	50,8 x 16	37,00	3	004400126
24x3	50,8 x 16	38,50	3	004400128

440ASW

Snijplaten, Whitworth draad verchromd staal

R ≤ 600 N/mm²



UNI EN 22568
DIN 223

BSW	Ø x S mm	€		
1/8x40	25,4 x 9	17,60	5	004400201
5/32x32	25,4 x 9	17,60	5	004400202
3/16x24	25,4 x 9	15,70	5	004400203
1/4x20	25,4 x 9	15,70	5	004400204
5/16x18	25,4 x 9	15,70	5	004400205
3/8x16	38,1 x 14	22,20	3	004400206
7/16x14	38,1 x 14	22,20	3	004400207
1/2x12	38,1 x 14	22,30	3	004400208
9/16x12	38,1 x 14	22,30	3	004400209
5/8x11	50,8 x 16	39,00	3	004400210
3/4x10	50,8 x 16	39,00	3	004400211
7/8x9	50,8 x 16	46,00	3	004400212
1"x8	50,8 x 16	46,00	3	004400213

440ASC

Snijplaten, grove spoed, UNC draad verchromd staal

R ≤ 600 N/mm²



UNI EN 22568
DIN 223

UNC	Ø x S mm	€		
1/4x20	25,4 x 9	15,50	5	004400221
5/16x18	25,4 x 9	15,50	5	004400222
3/8x16	38,1 x 14	21,60	3	004400223
7/16x14	38,1 x 14	21,60	3	004400224
1/2x13	38,1 x 14	21,80	3	004400225
9/16x12	38,1 x 14	21,80	3	004400226
5/8x11	50,8 x 16	44,00	3	004400227
3/4x10	50,8 x 16	44,00	3	004400228
7/8x9	50,8 x 16	44,00	3	004400229
1"x8	50,8 x 16	44,00	3	004400230

440ASF

Snijplaten, fijne spoed, UNF draad verchromd staal

UNI EN 2258
DIN 223

UNF	Ø x S mm	€		
1/4x28	25,4 x 9	16,00	5	004400241
5/16x24	25,4 x 9	16,00	5	004400242
3/8x24	38,1 x 14	22,60	3	004400243
7/16x20	38,1 x 14	22,60	3	004400244
1/2x20	38,1 x 14	22,60	3	004400245
9/16x18	38,1 x 14	22,60	3	004400246
5/8x18	50,8 x 16	47,50	3	004400247
3/4x16	50,8 x 16	47,50	3	004400248
7/8x14	50,8 x 16	47,50	3	004400249
1"x12	50,8 x 16	47,50	3	004400250

440ASG

Snijplaten, cilindrisch GAS draad verchromd staal

R ≤ 600 N/mm²



UNI EN 24231
DIN 223

GAS	Ø x S mm	€		
1/8x28	38,1 x 14	18,40	3	004400255
1/4x19	38,1 x 14	18,40	3	004400256
3/8x19	38,1 x 14	18,40	3	004400257
1/2x14	50,8 x 16	37,00	3	004400259
3/4x14	50,8 x 16	37,00	3	004400260
1"x11	63,5 x 19	75,00	3	004400261

441

Snijplaten, fijne spoed, metrische draad verchromd staal

R ≤ 600 N/mm²
HRC || 60÷61



UNI 4535
DIN 223

M	Ø x S mm	€		
6x0,75	25,4 x 9	15,90	5	004410004
7x0,75	25,4 x 9	15,90	5	004410005
8x0,75	25,4 x 9	15,90	5	004410006
8x1	25,4 x 9	15,90	5	004410007
9x0,75	25,4 x 9	15,90	5	004410008
9x1	25,4 x 9	15,90	5	004410009

441A

Snijplaten, fijne spoed, metrische draad verchromd staal

R ≤ 600 N/mm²
HRC || 60÷61



UNI 4535
DIN 223

M	Ø x S mm	€		
10x0,75	38,1 x 14	23,90	3	004410100
10x1	38,1 x 14	23,90	3	004410101
10x1,25	38,1 x 14	23,90	3	004410102
11x0,75	38,1 x 14	23,90	3	004410103
11x1	38,1 x 14	23,90	3	004410104
11x1,25	38,1 x 14	23,90	3	004410105
12x0,75	38,1 x 14	23,90	3	004410106
12x1	38,1 x 14	23,90	3	004410107
12x1,25	38,1 x 14	23,90	3	004410108
12x1,5	38,1 x 14	23,90	3	004410109
14x1	38,1 x 14	23,90	3	004410110
14x1,25	38,1 x 14	23,90	3	004410111
14x1,5	38,1 x 14	23,90	3	004410112
16x1	38,1 x 14	23,90	3	004410113
16x1,5	38,1 x 14	23,90	3	004410114
18x1,5	38,1 x 14	23,90	3	004410115

441B

Snijplaten, fijne spoed, metrische draad verchromd staal

R ≤ 600 N/mm²
HRC || 60÷61



UNI 4535
DIN 223

M	Ø x S mm	€		
18x1,5	50,8 x 16	43,50	3	004410117
18x2	50,8 x 16	43,50	3	004410118
20x1,5	50,8 x 16	44,00	3	004410119
22x1,5	50,8 x 16	46,00	3	004410120
24x1,5	50,8 x 16	47,00	3	004410121
24x2	50,8 x 16	47,00	3	004410122



442

Snijplaten, grove spoed, metrische draad HSS

HRC II 62+63
AISI M2



UNI EN 22568
DIN 223

M	ØxS mm	€		
3x0,5	20x5	18,20	3	004420003
4x0,7	20x5	18,20	3	004420004
5x0,8	20x7	19,10	3	004420005
6x1	20x7	19,10	3	004420006
7x1	25x9	21,00	3	004420007
8x1,25	25x9	21,00	3	004420008
10x1,5	30x11	24,90	3	004420010
12x1,75	38x14	37,00	3	004420012
14x2	38x14	49,00	1	004420014
16x2	45x18	63,50	1	004420016
18x2,5	45x18	67,50	1	004420018
20x2,5	45x18	67,50	1	004420020

443

Snijplaten, fijne spoed, metrische draad HSS

HRC II 62+63
AISI M2



UNI EN 22568
DIN 223

M	ØxS mm	€		
6x0,75	20x7	31,50	1	004430107
8x0,75	25x9	35,00	1	004430110
8x1	25x9	33,00	1	004430111
10x0,75	30x11	43,50	1	004430113
10x1	30x11	38,50	1	004430114
10x1,25	30x11	38,50	1	004430115
12x1	38x10	59,50	1	004430116
12x1,25	38x10	59,50	1	004430117
12x1,5	38x10	59,50	1	004430118
13x1,5	38x10	75,00	1	004430119
14x1	38x10	59,50	1	004430120
14x1,25	38x10	59,50	1	004430121
14x1,5	38x10	59,50	1	004430122
15x1,5	38x10	84,00	1	004430123
16x1	45x14	87,50	1	004430124
16x1,5	45x14	87,50	1	004430125
18x1,5	45x14	87,50	1	004430127
20x1,25	45x14	93,00	1	004430129
20x1,5	45x14	93,00	1	004430130
20x2	45x14	93,00	1	004430131
22x1,5	55x16	111,00	1	004430132
24x1	55x16	115,50	1	004430133
24x1,5	55x16	115,50	1	004430135
24x2	55x16	120,50	1	004430136

444

Snijplaat houders hamerslag stalen huis



EN 22568
DIN 225

	Ø mm	L mm	€		
444	20x5	190	25,00	5	004440005
444/0	20x7	190	25,00	5	004440007
444/1	25,4x9,5	210	26,00	5	004440025
444/1A	25x9	215	27,00	5	004440027
444/1B	30x11	250	30,50	5	004440030
444/C	38x10	310	36,50	3	004440033
444/1C	38x14	310	36,50	3	004440035
444/2	38,1x12,7	300	39,00	3	004440038
444/1D	45x14	445	53,50	1	004440045
444/2D	45x18	445	53,50	1	004440046
444/3	50,8x15,9	520	77,50	1	004440050
444/4	55x16	495	77,50	1	004440055
444/5A	63,5x19	520	133,00	1	004440057

444G

Snijplaat houders hamerslag gietstalen huis



UNI EN 22568
DIN 225

	Ø mm	L mm	€		
444G/A	16x5	160	11,80	5	004440103
444G	20x5	185	13,60	5	004440105
444G/0	20x7	185	13,60	5	004440107
444G/1	25,4x9,5	215	15,50	5	004440125
444G/1A	25x9	215	15,50	5	004440127
444G/1B	30x11	265	20,50	5	004440130
444G/C	38x10	315	27,50	3	004440133
444G/1C	38x14	315	27,50	3	004440135
444G/2	38,1x12,6	310	27,50	3	004440138
444G/1D	45x14	450	38,00	1	004440145
444G/2D	45x18	450	39,00	1	004440146
444G/3	50,8x16	485	42,00	1	004440150
444G/4	55x16	560	50,50	1	004440155
444G/5A	63,5x19	630	88,50	1	004440163
444G/6	65x18	630	95,50	1	004440165



446/C30

Assortiment van verchroomde tappen en snijplaten, metrische draad, met toebehoren in houten kist



446/C30 € 369,00 1 004460055
325x220x35 mm - 3,2 Kg

430 M mm	440 M mm		
3x0,5	3x0,5	435/1,5	444/1
4x0,7	4x0,7		
5x0,8	5x0,8		
6x1	6x1		
8x1,25	8x1,25		
10x1,5	10x1,5		
12x1,75	12x1,75		

446/C48

Assortiment van verchroomde tappen en snijplaten, metrische draad, met toebehoren in houten kist



446/C48 € 716,00 1 004460057
580x300x50 mm - 5 Kg

430 M mm	440 M mm	440A M mm		
3x0,5	3x0,5	10x1,5	435/1	444/1
4x0,7	4x0,7	12x1,75	435/3	444/2
5x0,8	5x0,8	14x2		
6x1	6x1	16x2		
8x1,25	8x1,25	18x2,5		
10x1,5		20x2,5		
12x1,75				
14x2				
16x2				
18x2,5				
20x2,5				

446/C110

Assortiment van verchromde tappen en snijplaten, metrische draad, met toebehoren in houten kist



446/C110 € 999,00 1 004460060

500x337x60 mm - 8,1 Kg

430 M mm	433 M mm	440/440A M mm	441/441A M mm
2x0,4	6x0,75	2x0,4	6x0,75
3x0,5	7x0,75	3x0,5	7x0,75
4x0,7	8x0,75	4x0,7	8x0,75
5x0,8	8x1	5x0,8	8x1
6x1	9x0,75	6x1	9x0,75
7x1	9x1	7x1	9x1
8x1,25	10x0,75	8x1,25	10x0,75
9x1,25	10x1	9x1,25	10x1
10x1,5	10x1,25	10x1,5	10x1,25
11x1,5	11x0,75	11x1,5	11x0,75
12x1,75	11x1	12x1,75	11x1
14x2	11x1,25	14x2	11x1,25
16x2	12x0,75	16x2	12x0,75
	12x1		12x1
	12x1,25		12x1,25
	12x1,5		12x1,5
	14x1		14x1
	14x1,25		14x1,25
	14x1,5		14x1,5
	16x1		16x1
	16x1,5		16x1,5
	18x1,5		18x1,5



446ASF/C29

Assortiment van verchromd stalen tappen en snijplaten, UNF draad, met toebehoren in houten kist



446ASF/C29 € 825,00 1 004460070

660x410x50 mm - 6 Kg

433ASF	440ASF		
1/4	1/4	435/1,5	444/1
5/16	5/16	435/3	444/2
3/8	3/8		444/3
7/16	7/16		
1/2	1/2		
9/16	9/16		
5/8	5/8		
3/4	3/4		

446ASC/C37

Assortiment van verchromd stalen tappen en snijplaten, UNC draad, met toebehoren in houten kist



446ASC/C37 € 869,00 1 004460080

660x410x50 mm - 6,7 Kg

430ASC	440ASC		
1/4	1/4	435/1,5	444/1
5/16	5/16	435/3	444/2
3/8	3/8		444/3
7/16	7/16		
1/2	1/2		
9/16	9/16		
5/8	5/8		
3/4	3/4		

446ASW/C36

Assortiment van verchromd stalen tappen en snijplaten, Whitworth draad, met toebehoren in houten kist



446ASW/C36 € 589,00 1 004460075

525x310x50 mm - 3,4 Kg

430ASW	440ASW		
1/8	1/8	435/1,5	444/1
5/32	5/32	435/2	444/2
3/16	3/16		
1/4	1/4		
5/16	5/16		
3/8	3/8		
7/16	7/16		
1/2	1/2		

446ASG/C23

Assortiment van verchromd stalen tappen en snijplaten, cilindrisch GAS draad, met toebehoren in houten kist



446ASG/C23 € 1.250,00 1 004460085

700x430x70 mm - 9,8 Kg

433ASG	440ASG		
1/8	1/8	435/3	444/2
1/4	1/4	435/5	444/3
3/8	3/8		444/5A
1/2	1/2		
3/4	3/4		
1"	1"		

Beta

447/C37

Assortiment van HSS tappen en snijplaten, metrische draad, met toebehoren in metalen kist



447/C37 € 758,00 1 004470055

≡ 380x185x35 mm - 3,9 Kg

431 M mm	442 M mm		
3x0,5	3x0,5	435/0	444
4x0,7	4x0,7	435/2	444/0
5x0,8	5x0,8		444/1A
6x1	6x1		444/1B
8x1,25	8x1,25		444/1C
10x1,5	10x1,5		
12x1,75	12x1,75		

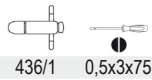

447/C53

Assortiment van HSS tappen en snijplaten, metrische draad, met toebehoren in metalen kist



447/C53 € 1.565,00 1 004470060

≡ 500x235x50 mm - 9 Kg

431 M mm	442 M mm			
3x0,5	3x0,5	435/1,5	444	436/1
4x0,7	4x0,7	435/3	444/0	436/2
5x0,8	5x0,8		444/1A	
6x1	6x1		444/1B	
8x1,25	8x1,25		444/1C	
10x1,5	10x1,5		444/2D	
12x1,75	12x1,75			
14x2	14x2			
16x2	16x2			
18x2,5	18x2,5			
20x2,5	20x2,5			

447/C70

Assortiment van HSS tappen en snijplaten, metrische draad, met toebehoren in houten kist



447/C70 € 1.965,00 1 004470065

≡ 510x340x70 mm - 7,5 Kg

431 M mm	434 M mm	442 M mm	443 M mm
3x0,5	8x1	3x0,5	8x1
4x0,7	10x1,25	4x0,7	10x1,25
5x0,8	12x1,25	5x0,8	12x1,25
6x1	12x1,5	6x1	12x1,5
7x1	14x1,25	7x1	14x1,25
8x1,25	14x1,5	8x1,25	14x1,5
10x1,5	16x1,5	10x1,5	16x1,5
12x1,75		12x1,75	
14x2		14x2	
16x2		16x2	

435/0	444	436/1
435/3	444/0	
	444/1A	
	444/1B	
	444/C	
	444/1C	
	444/1D	
	444/2D	

450

Gatzaag, Bi-metal HSS-Co 8%



HSS-Co 8%

Ø mm	Ø	A mm	€		
16	(5/8)	57	20,70	1	004500016
17	(11/16)	57	20,70	1	004500017
19	(3/4)	51	20,70	1	004500019
20	-	51	20,70	1	004500020
21	(13/16)	51	20,70	1	004500021
22	(7/8)	51	20,70	1	004500022
24	(15/16)	51	20,70	1	004500024
25	(1")	51	21,80	1	004500025
27	(1 1/16)	51	22,30	1	004500027
29	(1 1/8)	51	22,30	1	004500029
30	(1 3/16)	51	22,30	1	004500030
32	(1 1/4)	51	23,00	1	004500032
33	(1 5/16)	51	23,60	1	004500033

Ø mm	Ø	A mm	€		
35	(1 3/8)	51	25,00	1	004500035
37	(1 7/16)	51	25,00	1	004500037
38	(1 1/2)	44	26,00	1	004500038
40	(1 9/16)	44	26,50	1	004500040
41	(1 5/8)	44	27,50	1	004500041
43	(1 11/16)	44	27,50	1	004500043
44	(1 3/4)	44	29,00	1	004500044
46	(1 13/16)	44	29,00	1	004500046
48	(1 7/8)	44	30,00	1	004500048
51	(2")	44	30,50	1	004500051
52	(2 1/16)	44	35,50	1	004500052
54	(2 1/8)	44	35,50	1	004500054
57	(2 1/4)	44	35,50	1	004500057
59	(2 5/16)	44	37,50	1	004500059
60	(2 3/8)	44	37,50	1	004500060
64	(2 1/2)	44	37,50	1	004500064
65	(2 9/16)	44	37,50	1	004500065
67	(2 5/8)	44	37,50	1	004500067
68	-	44	37,50	1	004500068
70	(2 3/4)	44	38,50	1	004500070
73	(2 7/8)	44	38,50	1	004500073
76	(3")	44	41,50	1	004500076
79	(3 1/8)	44	43,00	1	004500079
83	(3 1/4)	44	44,00	1	004500083
86	(3 3/8)	44	44,00	1	004500086
89	(3 1/2)	44	46,00	1	004500089
92	(3 5/8)	44	49,00	1	004500092
95	(3 3/4)	44	50,00	1	004500095
98	(3 7/8)	44	52,00	1	004500098
102	(4")	44	55,00	1	004500102
105	(4 1/8)	44	60,50	1	004500105
108	(4 1/4)	44	74,50	1	004500108
111	(4 3/8)	44	86,00	1	004500111
114	(4 1/2)	44	96,00	1	004500114
121	(4 3/4)	44	106,50	1	004500121
127	(5")	44	116,50	1	004500127
140	(5 1/2)	44	142,00	1	004500140
152	(6")	44	164,00	1	004500152

450AL

Houders voor gatzaag met centreerboor



	Ø mm	L mm	€		
450AL/1	16÷30	54	25,00	1	004500210
450AL/2	32÷152	70	58,50	1	004500215

450AD

Adapter voor houders/gatzaag 450AL/1



	Ø mm	€		
450AD	32÷51	9,80	1	004500230

Beta
Quality Tools

450PA/1

Centreerboren voor houders 450AL/1
HSS

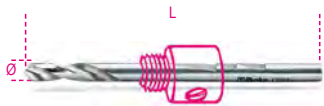

ØxL
mm
6,35x105 € 15,60 1 004500252

450PA/2

Centreerboren voor houders 450AL/2
HSS

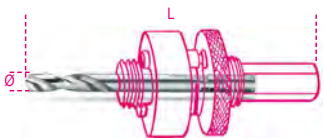

ØxL
mm
6,35x80 € 15,60 1 004500253

450PR

Verlengstuk voor gatzagen



L
mm
305 € 42,50 1 004500255

450/C9

9-delig assortiment gatzagen
en toebehoren voor de elektriciens



HSS-Co 8%

450/C9 € 295,00 1 004500305

450 Ø 22 - 29 - 35 - 44 - 51 - 64 mm

450AL /1 - /2

450AD

220x160x60 mm - 1,6 Kg

450/C13

13-delig assortiment gatzagen
en toebehoren voor de installateur



HSS-Co 8%

450/C13 € 369,00 1 004500310

450 Ø 19 - 22 - 29 - 35 - 38
44 - 51 - 57 - 64 mm

450AL /1 - /2

450PA/1

450AD

215x180x65 mm - 1,8 Kg

450/C15

Assortiment gatzagen
en toebehoren voor elektriciens



HSS-Co 8%

450/C15 € 481,00 1 004500313

450 Ø 16 - 20 - 25 - 32 - 40
51 - 60 - 65 - 70 mm

450AL /1 - /2

450PA /1 - /2

450PR

450AD

420x185x60 mm - 3,2 Kg

450/C21

21-delig assortiment gatzagen
en toebehoren voor industriële
toepassingen



HSS-Co 8%

450/C21 € 827,00 1 004500315

450 Ø 19 - 22 - 29 - 35 - 38
44 - 51 - 57 - 64 - 76
83 - 92 - 95 - 105 - 114 mm

450AL /1 - /2

450PA /1 - /2

450PR

450AD

420x280x60 mm - 7 Kg

451

Gatfrezen HSS, volledig geslepen



Ø mm	L mm	D mm	€	1	004510012
12	85	8	30,00	1	004510012
13	85	8	30,00	1	004510013
14	85	8	30,50	1	004510014
15	85	10	30,50	1	004510015
16	85	10	30,50	1	004510016
17	85	10	30,50	1	004510017
18	85	10	30,50	1	004510018
19	85	10	32,00	1	004510019
20	85	10	33,00	1	004510020
21	85	10	35,00	1	004510021
22	85	10	36,50	1	004510022
23	85	10	38,00	1	004510023
24	85	10	39,00	1	004510024
25	85	10	40,50	1	004510025
26	90	10	43,50	1	004510026
27	90	10	46,50	1	004510027
28	90	10	47,50	1	004510028
29	90	10	49,00	1	004510029
30	90	10	49,50	1	004510030
31	90	10	51,00	1	004510031
32	90	10	52,50	1	004510032
33	90	10	54,00	1	004510033
34	90	10	55,50	1	004510034
35	90	10	57,00	1	004510035
36	85	10	59,50	1	004510036
37	85	10	60,50	1	004510037
38	85	10	61,00	1	004510038
39	85	10	61,50	1	004510039
40	85	10	64,00	1	004510040
41	85	10	65,50	1	004510041
42	85	10	69,50	1	004510042
43	85	10	70,50	1	004510043
44	85	10	72,50	1	004510044
45	85	10	74,50	1	004510045
46	85	10	75,50	1	004510046
47	85	10	77,50	1	004510047
48	85	10	81,50	1	004510048
49	85	10	82,50	1	004510049
50	85	10	83,00	1	004510050

451/C

assortiment van 8 gatfrezen,
HSS



451/C8	€ 325,00	1	004510308
Ø 16-18-20-22-25-30-32-35 mm			

270x225x70 mm

451GA

Houders voor gatfrezen 451



M	Ø mm	L mm	D mm	€		
10x1,25	12÷14	57	8	17,00	1	004510101
12x1,25	15÷34	57	10	17,00	1	004510102
14x1,5	35÷50	57	10	21,50	1	004510105

451PA

Centreer boor voor gatfrezen 451
HSS



Ø mm	L mm	€		
6	53	9,40	1	004510103

451PR

Verlengstuk voor gatfrezen model 451



M	Ø mm	L mm	Ø1 mm	€		
12x1,25	15÷34	400	13	75,50	1	004510104
14x1,5	35÷50	400	13	75,50	1	004510108

Beta

452

Gatfrezen met hardmetalen tanden

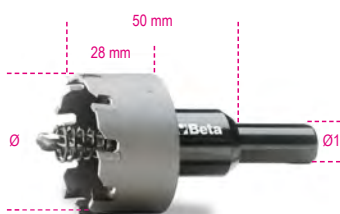

Ø mm	Ø1 mm	€		
15	10	122,00	1	004520015
16	10	122,00	1	004520016
17	10	122,00	1	004520017
18	10	122,00	1	004520018
19	10	122,00	1	004520019
20	10	122,00	1	004520020
21	10	122,00	1	004520021
22	10	122,00	1	004520022
23	10	122,00	1	004520023
24	10	122,00	1	004520024
25	10	122,00	1	004520025
26	10	137,00	1	004520026
27	10	137,00	1	004520027
28	10	137,00	1	004520028
29	10	137,00	1	004520029
30	10	137,00	1	004520030
31	10	164,00	1	004520031
32	10	164,00	1	004520032
33	10	164,00	1	004520033
34	10	164,00	1	004520034
35	10	164,00	1	004520035
36	10	190,00	1	004520036
37	10	190,00	1	004520037
38	10	190,00	1	004520038
39	13	190,00	1	004520039
40	13	190,00	1	004520040
41	13	212,50	1	004520041
42	13	212,50	1	004520042
43	13	212,50	1	004520043
44	13	212,50	1	004520044
45	13	212,50	1	004520045
46	13	237,00	1	004520046
47	13	237,00	1	004520047
48	13	237,00	1	004520048
49	13	237,00	1	004520049
50	13	237,00	1	004520050
55	13	265,00	1	004520055
60	13	352,00	1	004520060
65	13	352,00	1	004520065
70	13	421,00	1	004520070
75	13	451,00	1	004520075
80	13	491,00	1	004520080
85	13	554,00	1	004520085
90	13	599,00	1	004520090

452GA

Houders voor gatfrezen 452



	Ø mm	€		
452GA/1	15÷21	15,60	1	004520125
452GA/2	22÷38	18,20	1	004520126
452GA/3	39÷100	21,40	1	004520127

460

Gatfrezen voor de bouw

- Voor beton, cement, natuur- en kunstmatige steen
- Maximale boordiepte: 60 mm

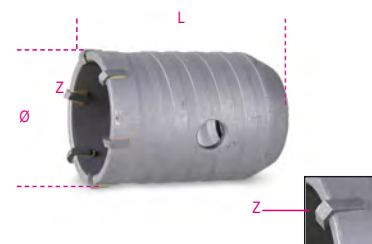

Ø mm	L mm	Z	€		
50	75	6	58,50	1	004600050
60	75	6	69,50	1	004600060
65	75	6	72,50	1	004600065
80	75	6	108,50	1	004600080
90	75	6	114,50	1	004600090
100	75	8	140,50	1	004600100
112	75	8	160,50	1	004600112
125	80	10	200,00	1	004600125
150	80	12	269,00	1	004600150

460PP

Centreerboor voor gatfrezen voor de bouw
460



Ø mm	L mm	€		
8	120	6,65	1	004600201

460G

Houders voor gatfrezen 460



L mm	€		
220	36,00	1	004600222
370	50,00	1	004600237
460	79,50	1	004600246

KRACHTVERMEERDERAARS

Krachtvermeerderaars essentiële gereedschappen voor het aandraaien van moeren en bouten, omdat ze een hoger koppel mogelijk maken dan de bediener normaal zou toepassen, in kleine of moeilijk toegankelijke ruimtes. Ze hebben geen omvangrijke verlengstukken nodig, waardoor totale veiligheid wordt gegarandeerd.

Beta's reeks krachtvermeerderaars biedt een scala aan oplossingen en capaciteiten tot **9500 Nm**, en krachtvermenigvuldigingsverhoudingen tot 135: 1. Veel modellen - vooral de krachtigste - zijn uitgerust met een tweewegsysteem dat ontlaadt om te voorkomen dat gevaarlijke spanning terugkeert naar de bediener. Elk van de krachtvermeerderaars van Beta wordt geleverd met een **certificaat** dat bewijst dat het gereedschap is getest op de maximale waarde onder optimale bedrijfsomstandigheden.



Handleiding

De krachtvermeerderaar **moet worden gebruikt met een momentsleutel** om controle van het uitgaande koppel te garanderen; bovendien moet hij altijd worden gebruikt met **slagdoppen**.

De verhoudingen van elke krachtvermeerderaar bepalen de **vermenigvuldigingsfactor** tussen het ingaande koppel en het uitgaande koppel. Voorbeeld: krachtvermeerderaar met een verhouding van 5: 1. Het toepassen van een ingaand koppel van 100 Nm, zoals ingesteld op de momentsleutel, zal resulteren in een uitgaand koppel van 500 Nm zoals overgebracht op de moer of bout.

Zorg er echter voor dat alle onderdelen die bij het vastdraaien nodig zijn, correct zijn uitgelijnd.

Vermijd het gebruik van **verlengstukken**, aangezien deze zouden verdraaien, waardoor een veereffect ontstaat dat de toegepaste koppelwaarden zou wijzigen.

Controleer altijd of de **reactiearm** van de krachtvermeerderaar is bevestigd aan of rust op een stevige constructie die de reactiekracht kan weerstaan. In de regel worden voldoende stevige wanden of moeren gebruikt in de buurt van datgene waaraan moet worden gewerkt. De reactiearm draait altijd in de richting **tegengesteld** aan de aanhaalrichting.

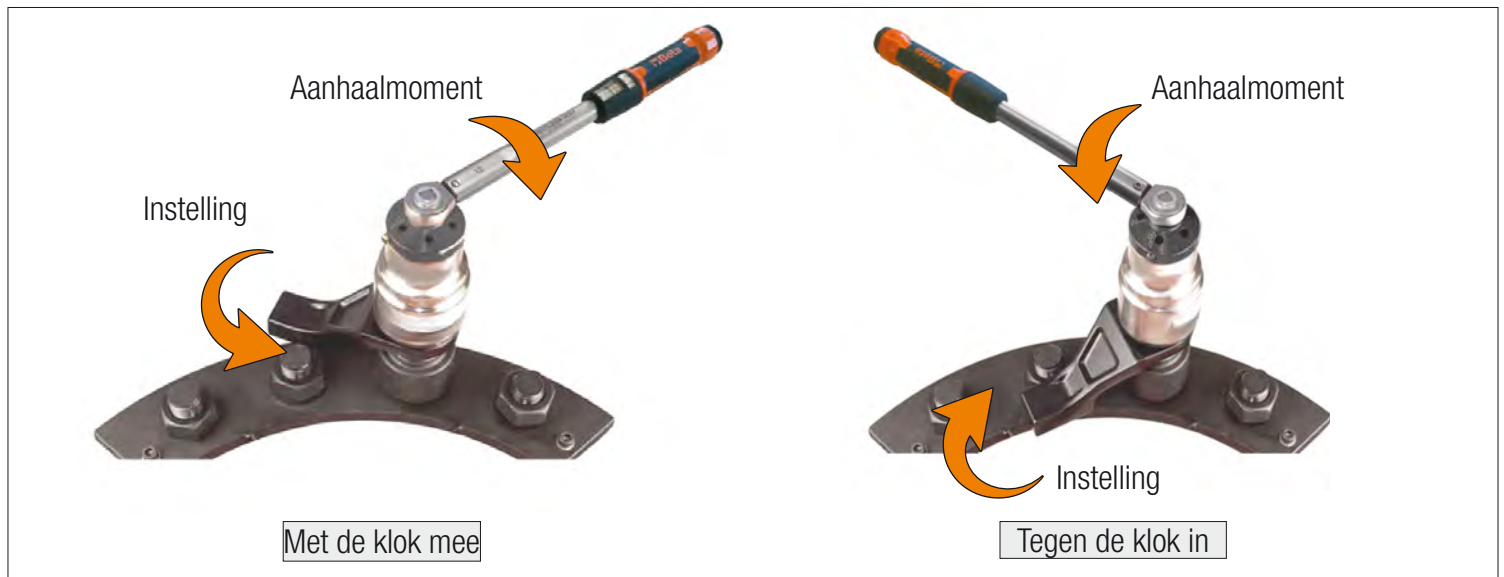

Werk soepel en ononderbroken.

De aanhaalspanning moet worden opgeheven door de krachtvermeerderaar in de andere richting te draaien, voordat deze wordt losgekoppeld; als de krachtvermeerderaar is uitgerust met een anti-opwindsysteem, moet de aanhaalspanning worden ontlast met de omkeerhendel.

De bovenstaande instructies zijn ook van toepassing op **losdraaien**.

560/C3

Krachtvermeerderaar voor links en rechtsom vastdraaien, in kunststof koffer, ratio 3.8:1 met anti-terugslag mechanisme

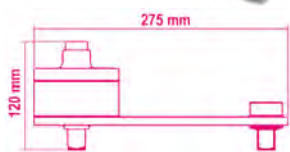

Nm	kgfm	lbf.ft	□	■	kg
1500	150	1110	1/2"	3/4"	3,9

	€		
560/C3	999,00	1	005600030

400x260x110 mm

560/C3PLUS

Krachtvermeerderaar voor links en rechtsom vastdraaien, in kunststof koffer, ratio 3.8:1 met anti-terugslag mechanisme

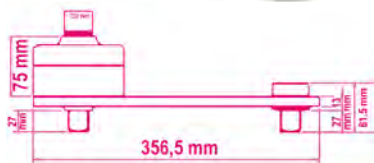

Nm	kgfm	lbf.ft	□	■	kg
2700	270	1991	3/4"	1"	7,5

	€		
560/C3PLUS	1.150,00	1	005600038

470x240x160 mm

560/C2

Krachtvermeerderaar voor rechts-/links aandraaien en accessoires verhouding 5:1 in kunststof koffer voor intensief gebruik

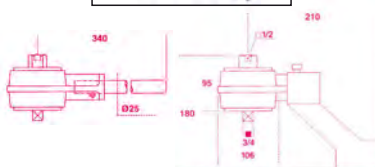

Nm	Kgfm	lbf.ft	□	■	kg
1300	130	960	1/2	3/4	3,8

	€		
560/C2	1.990,00	1	005600020
560/2	1.450,00	1	005600002
560/18	49,50	1	005600018
560/19	104,00	1	005600019
560/22	369,00	1	005600022

310x275x120 mm

560/C4+

Krachtvermeerderaar voor rechts/links en accessoires met reactievoet voor intensief gebruik

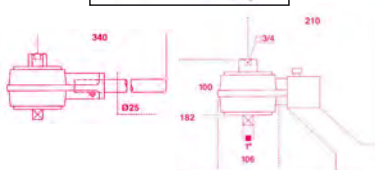

Nm	Kgfm	lbf.ft	□	■	kg
2700	270	2000	3/4	1"	5

	€		
560/C4PLUS	2.005,00	1	005600042
560/4	1.570,00	1	005600004
560/18	49,50	1	005600018
560/22	369,00	1	005600022

310x275x120 mm

560/C6

Krachtvermeerderaar voor rechts en links aandraaien in kunststof koffer Overbrenging: 6.5:1



Nm	kgfm	lbf.ft	□	■	kg
1500	150	1106	1/2"	3/4"	6

	€		
560/C6	999,00	1	005600160

400x260x110 mm

560/C12

Krachtvermeerderaar voor rechts en links aandraaien in kunststof koffer Overbrenging: 12:1



Nm	kgfm	lbf.ft	□	■	kg
2500	250	1844	1/2"	1"	7

	€		
560/C12	1.450,00	1	005600210

400x260x110 mm

561/1

Krachtvermeerderaar voor links en rechtsom vastdraaien, ratio 5:1, met twee reactie voetplaten

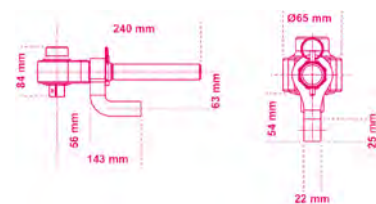

Nm	kgfm	lbf.ft	□	■	kg
1000	100	740	1/2	3/4	2,7

	€		
561/1	1.500,00	1	005610010

270x210x70 mm

562-1/VA - 562-2/VA

Krachtvermeerderaar voor rechts- en linksom aandraaien
verhouding 5,2:1
in koffer 562VV-A



Nm	Kgfm	lbf.ft	□	■	D	A	L min	L max	⊞
1700	170	1250	3/4	1"	mm	mm	mm	mm	kg
					108	95	85	220	8,8

562-1/VA € 3.250,00 1 005620601

Nm	Kgfm	lbf.ft	□	■	D	A	L min	L max	⊞
3400	340	2500	3/4	1"	mm	mm	mm	mm	kg
					119	115	85	265	10,5

562-2/VA € 3.870,00 1 005620602

564-3R/V - 564-4R/V

Krachtvermeerderaar voor rechts-/linksom aandraaien

verhouding 25:1
met anti-opwindsysteem,
in koffer



Nm	Kgfm	lbf.ft	□	■	D	A	L	⊞
4000	400	3000	1/2	1"	mm	mm	mm	kg
					92	185	205	7,6

564-3R/V € 6.250,00 1 005640613

≡ 390x310x145 mm

Nm	Kgfm	lbf.ft	□	■	D	A	L	⊞
7000	700	5000	1/2	1 1/2"	mm	mm	mm	kg
					120	200	210	13,2

564-4R/V € 7.400,00 1 005640614

≡ 500x435x170 mm

565-1R/VA - 565-2R/VA - 565-3R/VA

Krachtvermeerderaar voor rechts- en linksom aandraaien
verhouding 27:1
met anti-opwindsysteem,
in koffer 562VV-A



Nm	Kgfm	lbf.ft	□	■	D	A	L min	L max	⊞
1700	170	1250	1/2	1"	mm	mm	mm	mm	kg
					108	125	80	215	11,2

565-1R/VA € 5.250,00 1 005650611

Nm	Kgfm	lbf.ft	□	■	D	A	L min	L max	⊞
3400	340	2500	1/2	1"	mm	mm	mm	mm	kg
					119	145	85	265	13,6

565-2R/VA € 6.840,00 1 005650612

Nm	Kgfm	lbf.ft	□	■	D	A	L min	L max	⊞
3400	340	2500	1/2	1 1/2"	mm	mm	mm	mm	kg
					119	145	85	265	14,2

565-3R/VA € 7.260,00 1 005650613

565-4R/VB

Krachtvermeerderaar voor rechts- en linksom aandraaien
verhouding 27:1
met anti-opwindsysteem,
in koffer 565VV-B

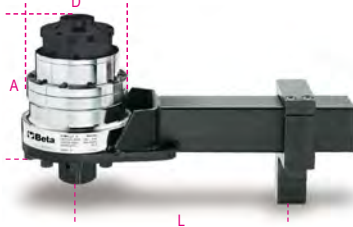

Nm	Kgfm	lbf.ft	□	■	D	A	L min	L max	⊞
6000	600	4500	1/2	1 1/2"	mm	mm	mm	mm	kg
					144	180	125	335	22,4

565-4R/VB € 8.080,00 1 005650614

565-5R/VB

Krachtvermeerderaar voor rechts- en linksom aandraaien
verhouding 27:1
met anti-opwindsysteem,
in koffer 565VV-B

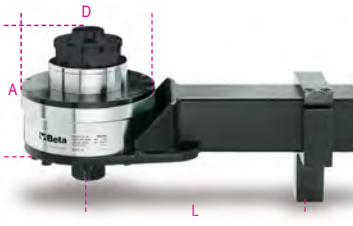

Nm	Kgfm	lbf.ft	□	■	D	A	L min	L max	⊞
9500	950	7000	3/4	1 1/2"	mm	mm	mm	mm	kg
					184	180	155	355	30,4

565-5R/VB € 13.420,00 1 005650615

567-4R/VB

Krachtvermeerderaar voor rechts- en linksom aandraaien
verhouding 135:1
met anti-opwindsysteem,
in geval 565VV-B



Nm	Kgfm	lbf.ft	□	■	D	A	L min	L max	⊞
6000	600	4500	1/2	1 1/2"	mm	mm	mm	mm	kg
					144	210	125	335	24,4

567-4R/VB € 9.040,00 1 005670614

567-5R/VB

Krachtvermeerderaar voor rechts- en linksom aandraaien
verhouding 135:1
met anti-opwindsysteem,
in geval 565VV-B

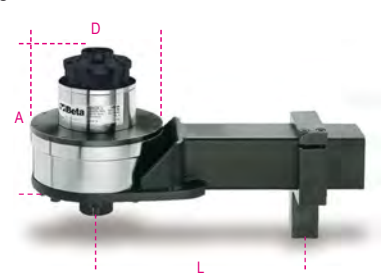

Nm	Kgfm	lbf.ft	□	■	D	A	L min	L max	⊞
9500	950	7000	1/2	1 1/2"	mm	mm	mm	mm	kg
					184	210	155	350	32,4

567-5R/VB € 15.630,00 1 005670615

562VV-A

Koffer voor krachtvermeerderaar,
vervaardigd uit slijtvast polypropyleen met
zachte inleg
Binnen afmetingen: 380x270x180 mm



562VV-A € 279,00 1 005620501

562/1-562/2-564/3R
564/4R-565/1R-565/2R
565/3R

≡ 410x340x205 mm - ⊞ 3,5 kg

565VV-B

Koffer voor krachtvermeerderaar,
vervaardigd uit slijtvast polypropyleen met
zachte inleg
Binnen afmetingen: 480x370x205 mm



565VV-B € 390,00 1 005650502

565/4R-565/5R
567/4R-567/5R

≡ 520x435x230 mm - ⊞ 5,4 kg



Momentsleutels moeten altijd in het midden van de handgreep worden gehouden om de hefboomverhouding niet te veranderen. Ze moeten soepel en ononderbroken worden bediend, waarbij schokken worden vermeden.



Om de nauwkeurigheid van het vastdraaien niet te beïnvloeden, moet de instelschaal na gebruik op nul worden gezet. Met de Zero-Reset sleutels is dit niet nodig.



Beta biedt een breed scala aan sleutels, met **vier verschillende soorten werkingen**.

DIRECTE AFLEESBARE MODELLEN

Het toegepaste aanhaalmoment wordt door compressie van een schroefveer direct op de afleesschaal overgedragen. Het toegepaste koppel kan in direct worden afgelezen door een wijzer. Een tweede sleepwijzer kan op de doelkoppelwaarde worden geplaatst. Wanneer de doelkoppelwaarde is bereikt, wordt de tweede wijzer door de hoofdwijzer gehaakt en wordt de piekwaarde geregistreerd. Momentsleutels met directe aflezing zorgen voor een opmerkelijke nauwkeurigheid en duurzaamheid in de loop van de tijd.

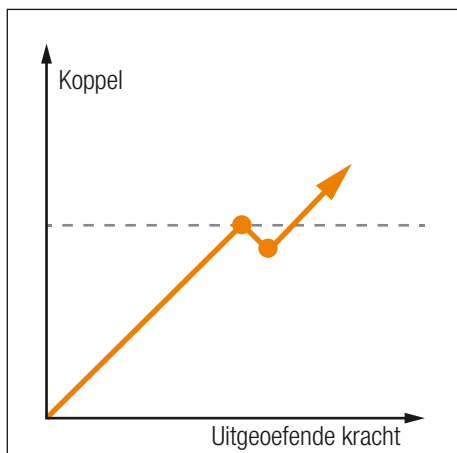

MODELLEN MET KLIKMECHANISME

Momentsleutels met kliksysteem zijn de meest populaire modellen, omdat ze gemakkelijk te gebruiken zijn. Ze maken een snelle voorselectie van het koppel mogelijk door middel van veerbelasting. De koppelwaarde neemt toe naarmate de uitgeoefende kracht toeneemt. Wanneer het vereiste aanhaalmoment is bereikt, zal een plotselinge release plaatsvinden en zal de sleutel gedurende ongeveer 3-5 ° geen aandruaikracht uitoefenen. Als de bediener de beweging niet onderbreekt, zal het koppel blijven toenemen, waardoor de vereiste waarden worden overschreden.

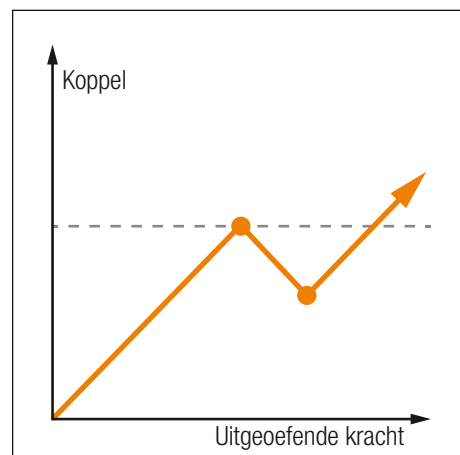

MODELLEN MET KNIKMECHANISME

Momentsleutels met knikmechanisme werken als klikmodellen, maar wanneer het vereiste aanhaalmoment is bereikt, zal de hefboomarm plotseling doorknikken (ongeveer 20 °). Daarom is het gemakkelijker voor de bediener om te stoppen met het uitoefenen van kracht. Ze worden normaal gesproken gebruikt voor hoge koppelwaarden met extreem lange hefboomarmen.

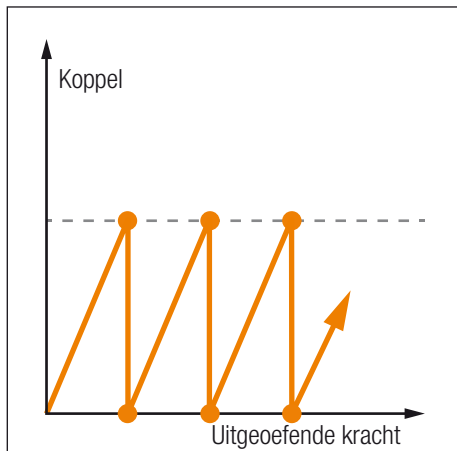

MODELLEN MET SLIPMECHANISME

Wanneer de vooraf ingestelde koppelwaarde is bereikt, stopt het slipmechanisme dat het koppel wordt uitgeoefend, waardoor het gereedschap inactief wordt. Dit voorkomt aanhalen met hoge aanhaalmomenten in vergelijking met de vereiste waarden. Als u kracht blijft uitoefenen, wordt dezelfde cyclus herhaald. Ze zijn ideaal voor opeenvolgende bewerkingen met lage koppelwaarden (elektronische en fijnmechanische industrieën), waarbij het vermijden van breken van delicate of kleine onderdelen een prioriteit is.

GEBRUIKSMOGELIJKHEDEN VOOR MOMENTSLEUTELS EN TORSIESLEUTELS

1 Nm = 0,10197 Kgfm = 0,7375 lbf.ft



Size	Model	Image	Min Nm	Max Nm	Min Kgfm	Max Kgfm	Min lbf.ft	Max lbf.ft
1/4"	590		0,8	4				
	590/1		2,5	12				
	603/5		1	5				
	603/10		2	10				
	605E/5		1	5				
	605E/10		2	10				
	666/2			5	25			
	666 LBF.FT/2			4 LBF.FT	18 LBF.FT			
3/8"	592/3		5	25				
	592/4		8	40				
	599DGT/6			12	60			
	665/6			10	60			
	665/10			20	100			
	665LB/6			7 LBF.FT	45 LBF.FT			
	665LB/10			15 LBF.FT	75 LBF.FT			
	666/2X		5	25				
	666/5		10	50				
	666/10			20	100			
	666 LBF.FT/2X			4 LBF.FT	18 LBF.FT			
	666 LBF.FT/5			7 LBF.FT	37 LBF.FT			
	666 LBF.FT/10			15 LBF.FT	75 LBF.FT			
	668RGC/6			12	60			
	668RGC/10			20	100			
	1/2"	594/8			16	80		
594/21				40	200			
599DGT/10X				20	100			
599DGT/20				40	200			
599DGT/30				68	340			
599DGT-AN/10				20	100			
599DGT-AN/20				40	200			
606MQ/50			5	50				
610/5						90	130	
610L/5						90	130	
610L/5L						120	200	
665/10X				20	100			
665/20				40	200			
665/30				60	330			
665LB/10X				15 LBF.FT	75 LBF.FT			
665LB/20				30 LBF.FT	150 LBF.FT			
665LB/30				45 LBF.FT	240 LBF.FT			
666/10X				20	100			
666/20				40	200			
666/30				60	300			
666 LBF.FT/10X				15 LBF.FT	75 LBF.FT			
666 LBF.FT/20				30 LBF.FT	150 LBF.FT			
666 LBF.FT/30				50 LBF.FT	230 LBF.FT			
667/20				40	200			
667/30			60	300				
668RGC/10X			20	100				
668RGC/20			40	200				



Beta

581

Momentschroevendraaier met slipmechanisme, zonder schaalverdeling
Voor het rechtsom vastzetten
Torsie nauwkeurigheid: $\pm 6\%$
(te gebruiken in combinatie met artikel 588 - 682)



UNI EN ISO 6789

Nm	gfm	O	g
1,2÷6	120÷600	1/4"	275

581 € 325,00 1 005810001

583

Momentschroevendraaier met slipmechanisme en schaalverdeling
Voor het rechtsom vastdraaien
Torsie nauwkeurigheid: $\pm 6\%$



UNI EN ISO 6789

Nm	gfm	O	g	kg
0,3÷1,5	30÷150	1/4"	240	0,05

583/1,5 € 351,00 1 005830015

Nm	gfm	O	g	kg
0,6÷3	60÷300	1/4"	240	0,1

583/3 € 351,00 1 005830030

Nm	gfm	O	g	kg
1,2÷6	120÷600	1/4"	350	0,2

583/6 € 351,00 1 005830060

583/C31

Set van 1 momentschroevendraaier, 8 zeskant dopsleutels, 20 bits en 2 toebehoren

1/4



583/C31 € 498,00 1 005830931

	583/6	1.2 - 6 Nm
	900	4-5-5-6-7-8-9-10 mm
	860LP	0,6x4,5 - 1x5,5 - 1,2x6,5 mm
	860PH	PH1 - PH2 (x2) - PH3
	860PE	2-2,5-3-4-5 mm
	860TX	T9-T10-T15-T20-T25-T27-T30-T40
	882P/80	80 mm
	892/0	● 1/4 ■ 1/4

270x120x45 mm - 1,2 kg

590 - 592

Momentsleutel met meetklok.
Voor rechts en linkshandig vastdraaien.
Torsie nauwkeurigheid: $\pm 4\%$

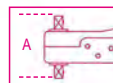

UNI EN ISO 6789

Nm	Kgfm	lbf.in	mm	A mm	L mm	kg	kg
0,3÷4	0,03÷0,4	3÷35	1/4	60	253	0,52	0,1

590 € 867,00 1 005900001

Nm	Kgfm	lbf.in	mm	A mm	L mm	kg	kg
0,5÷13,5	0,05÷1,35	4÷120	1/4	60	253	0,52	0,5

590/1 € 867,00 1 005900003

Nm	Kgfm	lbf.in	mm	A mm	L mm	kg	kg
1÷27	0,1÷2,7	10÷240	3/8	70	253	0,52	1,0

592/3 € 861,00 1 005920005

Nm	Kgfm	lbf.in	mm	A mm	L mm	kg	kg
3÷40	0,3÷4	20÷360	3/8	70	253	0,52	1,0

592/4 € 861,00 1 005920007

594

Momentsleutel met meetklok.
Voor rechts en linkshandig vastdraaien.
Torsie nauwkeurigheid: $\pm 4\%$

1/2

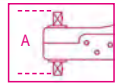

UNI EN ISO 6789

Nm	Kgfm	lbf.ft	mm	A mm	L mm	kg	kg
6÷80	0,6÷8	5÷60	1/2	85	455	1,35	2,0

594/8 € 1.305,00 1 005940011

Nm	Kgfm	lbf.ft	mm	A mm	L mm	kg	kg
20÷215	2÷21,5	15÷160	1/2	85	530	1,40	5,0

594/21 € 1.305,00 1 005940015

Calibratie service voor momentsleutels achterin de prijslijst

596 - 598

Momentsleutel met meetklok.
Voor rechts en linkshandig vastdraaien.
Torsie nauwkeurigheid: $\pm 4\%$

Een waarschuwingslicht en een geluidssignaal treden in werking zodra het ingestelde koppel bereikt is.

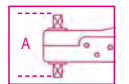

UNI EN ISO 6789

Nm	Kgfm	lbf.ft	mm	A mm	L mm	kg	kg
80÷400	8÷40	60÷300	3/4	111	710	3,2	10

596/40SL € 2.160,00 1 005960010

Nm	Kgfm	lbf.ft	mm	A mm	L mm	kg	kg
160÷800	16÷80	120÷600	3/4	115	1025	4,85	20

596/80SL € 2.630,00 1 005960020

Nm	Kgfm	lbf.ft	mm	A mm	L mm	kg	kg
200÷2000	20÷200	150÷1500	1"	135	1930	16,70	50

598/200SL € 5.660,00 1 005980022

Beta

Quality Tools

Beta

599DGT

Electronische momentsleutel met omschakelbare ratel, rechtsom (nauwkeurigheid: $\pm 2\%$) en links om (nauwkeurigheid: $\pm 3\%$) aanhalen

- Dubbele meetmogelijkheid: piek positie en verloop
- Lichtsignalen en duidelijk hoorbaar geluid waarschuwen de gebruiker zodra het ingestelde koppel bereikt is
- Voeding: 2 1.5V batterijen (meegeleverd)



UNI EN ISO 6789

Nm	Kgfm	lbf.ft	■	D	A	L	█	⚖
12÷60	1,2÷6	8÷44	3/8	30	33	413	0,9	0,1

599DGT/6	449,00	1	005990003
-----------------	---------------	---	-----------

Nm	Kgfm	lbf.ft	■	D	A	L	█	⚖
20÷100	2÷10	15÷80	1/2	30	37	413	0,9	0,1

599DGT/10X	463,00	1	005990010
-------------------	---------------	---	-----------

Nm	Kgfm	lbf.ft	■	D	A	L	█	⚖
40÷200	4÷20	30÷150	1/2	40	43	520	2	0,1

599DGT/20	485,00	1	005990020
------------------	---------------	---	-----------

Nm	Kgfm	lbf.ft	■	D	A	L	█	⚖
68÷340	6,8÷34	58÷280	1/2	40	43	640	2,35	0,1

599DGT/30	530,00	1	005990030
------------------	---------------	---	-----------

599DGT-AN

Elektronische momentsleutel, aanhaalmoment en draaihoek uitlezing, met omschakelbare ratel, rechtsom (nauwkeurigheid: $\pm 2\%$) en linksom (nauwkeurigheid: $\pm 3\%$) aanhalen

- Aanhaal opties: aanhaalmoment, hoek, aanhaal + hoek
- Dubbel meetbereik instelling: piek en verloop
- Lichtsignalen en duidelijk hoorbaar geluid waarschuwen de gebruiker dat de vooraf ingestelde waarde of hoek bereikt is.
- Data geheugen opslag (tot 1600 waarden)
- Tot 9 aanhaalkoppels/hoek metingen kunnen vooraf ingesteld worden
- Vergrendel knop
- De sleutel kan gekoppeld worden aan 16 gebruikers d.m.v gebruikers ID
- Aanhaal data traceerbaar. Software maakt het mogelijk datum en tijd, serie nummer gereedschap, ingestelde aanhaal koppel en bereikte waarde opgeslagen worden en gekoppeld aan de gebruikers ID
- Anti slip handgreep uit tweecomponenten materiaal
- Meegeleverd: 2 AA - 1.5V batterijen, USB kabel en software



UNI EN 26789
ISO 6789

Nm	Kgfm	lbf.ft	■	D	A	L	█	⚖
20÷100	2÷10	15÷80	1/2	30	33	413	0,9	0,1

599DGT-AN/10	836,00	1	005990610
---------------------	---------------	---	-----------

Nm	Kgfm	lbf.ft	■	D	A	L	█	⚖
40÷200	4÷20	30÷150	1/2	40	43	520	1,3	0,1

599DGT-AN/20	878,00	1	005990620
---------------------	---------------	---	-----------

Calibratie service voor momentsleutels achterin de prijslijst



600

Hoekverdraaiings-meters

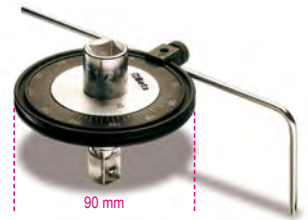

	□	■	€	⚖	⌨
600/1	1/2	1/2	191,00	1	006000001
600/2	3/4	3/4	211,50	1	006000002

601C

Digitale gradenboog

Lichtsignalen en wisselend geluid waarschuwen de gebruiker dat de ingestelde hoek bereikt is



601C	242,00	1	006010100
-------------	---------------	---	-----------

85x80x87 mm - 70 g

601CA

Digitale torsiemeter en gradenboog

Lichtsignalen en een wisselend geluid waarschuwen de gebruiker dat de vooringestelde torsie of hoek bereikt is.



□	■	Nm	⚖	€	⚖	⌨
1/2"	1/2"	40÷200	0,1	444,00	1	006010120

120x90x120 mm - 240 g

603

Momentsleutel met slipmechanisme voor rechtsom vastdraaien.
Torsie nauwkeurigheid: $\pm 6\%$



UNI EN ISO 6789

Nm	Kgfm	lbf.in	1/4	A mm	L mm	g	0,05
1÷5	0,1÷0,5	10÷45	1/4	35	195	235	0,05

603/5	747,00	1	006030005
-------	--------	---	-----------

Nm	Kgfm	lbf.in	1/4	A mm	L mm	g	0,1
2÷10	0,2÷1,0	18÷90	1/4	35	195	235	0,1

603/10	766,00	1	006030010
--------	--------	---	-----------

604B

Klik momentsleutels voor links en rechtsom vastdraaien
aanhaal nauwkeurigheid: $\pm 6\%$



UNI EN ISO 6789

Nm	Kgfm	lbf.in	Ø mm	L mm	g	0,025
1÷5	0,1÷0,5	10÷45	8	220	290	0,025

604B/5	497,00	1	006040015
--------	--------	---	-----------

Nm	Kgfm	lbf.in	Ø mm	L mm	g	0,05
2÷10	0,2÷1,0	18÷90	8	220	300	0,05

604B/10	497,00	1	006040020
---------	--------	---	-----------

605E

Momentsleutels me klikmechanisme en omschakelbare ratel voor links en rechtsom vastdraaien
Torsie nauwkeurigheid: $\pm 6\%$



UNI EN ISO 6789

Nm	Kgfm	lbf.in	1/4	A mm	L mm	g	0,05
1÷5	0,1÷0,5	10÷45	1/4	20	190	180	0,05

605E/5	238,00	1	006050105
--------	--------	---	-----------

Nm	Kgfm	lbf.in	1/4	A mm	L mm	g	0,1
2÷10	0,2÷1,0	18÷90	1/4	20	190	180	0,1

605E/10	248,00	1	006050110
---------	--------	---	-----------

605DGT/2

elektronische momentsleutel met omkeerbare ratel voor rechts/links vastdraaien
koppelnauwkeurigheid $\pm 3\%$ (rechts) $\pm 4\%$ (links)

- Dubbele meetmodus: peak hold en track
- Lichtindicatoren en een onderbroken geluid informeren de gebruiker dat het vooraf ingestelde koppel is bereikt
- Voeding: 1 AAA-batterij van 1,5 V (meegeleverd)



Nm	Kgcm	lbf.ft	1/4	D mm	A mm	L mm	g	0,01
4÷20	10÷204	0,75÷14,75	1/4	20	20	210	175	0,01

605DGT/2	350,00	1	006050302
----------	--------	---	-----------

610/5

Momentsleutels met klikmechanisme, omschakelbare ratels, voor het rechtsom vastdraaien, met 5 vaste ingestelde aanhaalmomenten,
Torsie nauwkeurigheid: $\pm 4\%$

Keuze uit aanhaalmomenten:
90 - 100 - 110 - 120 - 130 Nm



UNI EN ISO 6789

Nm	1/2	D mm	A mm	L mm	g	10
90÷130	1/2	42	39	490	1330	10

610/5	205,00	1	006100025
-------	--------	---	-----------

610L/5

Gebogen momentsleutel met klikmechanisme en 1/2" aandrijfvierkant, voor het rechtsom vastdraaien, met 5 vaste ingestelde aanhaalmomenten,
Torsie nauwkeurigheid: $\pm 4\%$

Keuze uit aanhaalmomenten:
90 - 100 - 110 - 120 - 130 Nm



UNI EN ISO 6789

Nm	1/2	L mm	L1 mm	g	10
90÷130	1/2	470	80	1350	10

610L/5	183,00	1	006100125
--------	--------	---	-----------

610L/5L

Gebogen momentsleutel met klikmechanisme voor rechtsom vastdraaien, met 5 vooraf ingestelde aanhaalmomenten,
Nauwkeurigheid: $\pm 4\%$

Keuze uit aanhaalmomenten:
120 - 140 - 160 - 180 - 200 Nm



UNI EN ISO 6789

Nm	1/2	L mm	L1 mm	g	20
120÷200	1/2	470	80	1400	20

610L/5L	192,00	1	006100150
---------	--------	---	-----------

611

Omschakelbare ratelkop voor momentsleutels type 604B/5 en 604B/10
8 mm aansluiting



1/4	L mm	€	1	006110001
1/4	42,5	180,00	1	006110001

Calibratie service voor momentsleutels achterin de prijslijst

612 ÷ 614

Omschakelbare ratelkop voor momentsleutels



Artikel 612 en 612X mogen niet gebruikt worden bij een koppel hoger dan 100Nm

612	3/8	L mm	LA mm	€	2	006120000
612	3/8	66	32	83,00	2	006120000

612X	1/2	66	32	89,00	2	006120010
------	-----	----	----	-------	---	-----------

614	1/2	71	32	95,50	2	006140000
-----	-----	----	----	-------	---	-----------

614X	3/4	71	32	101,00	2	006140004
------	-----	----	----	--------	---	-----------

614/50

Doorsteek ratelkop voor momnetsleutels



mm	mm	L mm	LA mm	€		
614/50	1/2	71	32	88,00	2	006140002

Zie de tabel na item 929/C8 voor de draaiende onderdelen van het ratelmechanisme

615

Omschakelbare ratelkop voor momnetsleutels, rechthoekige aansluiting



mm	mm	L mm	LA mm	€		
9x12	3/8	53	28,8	67,50	1	006150010
9x12	1/2	53	28,8	67,50	1	006150020
14x18	1/2	70	39,8	67,50	1	006150120

616 - 617 - 619

Vast opsteekvierkant voor momnetsleutels



mm	mm	L mm	LA mm	€		
616	1/4	61	32	62,00	1	006160000
617	3/8	61	32	62,00	1	006170000
619	1/2	63	32	62,00	1	006190000

621

Bithouder toebehoren voor momnetsleutels, rechthoekige aansluiting



mm	mm	L mm	LA mm	€		
621P 1/4	9x12	14	43 28,8	92,50	1	006210000
* 621P 5/16	14x18	5/16	52,5 32,5	138,00	1	006210110

*Opgelet! Herbereken de torsiewaarde volgens de tabel als afgebeeld aan het einde van de prijslijst.

622

Omschakelbare opsteekratel voor opsteekmomnetsleutel, ronde aansluiting, Ø 22 mm



mm	mm	L mm	LA mm	€		
622 3/4	3/4	110	56	220,00	1	006220019
622 1'	1	110	56	267,00	1	006220024

641

Opsteek steeksleutel voor momnetsleutels type 604B/5 en 604B/10 8 mm aansluiting



mm	L mm	€		
4	37	99,00	1	006410003
5	37	99,00	1	006410004
5,5	37	99,00	1	006410005
6	37	99,00	1	006410006
7	37	99,00	1	006410007
8	42	99,00	1	006410008
9	42	99,00	1	006410009
10	42	99,00	1	006410010

642

Opsteek steeksleutel voor momnetsleutels



mm	L mm	LA mm	A mm	€		
8	54	32	22	68,50	1	006420008
10	57	32	26	68,50	1	006420010
12	58	32	30	68,50	1	006420012
13	58	32	30	68,50	1	006420013
14	59	32	32	68,50	1	006420014
15	59	32	35	68,50	1	006420015
16	59	32	38	68,50	1	006420016
17	60	32	39	68,50	1	006420017
18	61	32	42	68,50	1	006420018
19	61	32	43	68,50	1	006420019
20	61	32	50	111,00	1	006420020
21	62	32	53	111,00	1	006420021
22	62	32	53	121,50	1	006420022
23	65	32	53	121,50	1	006420023
24	63	32	53	121,50	1	006420024
25	64	32	53	145,50	1	006420125
26	64	32	59	145,50	1	006420026
27	65	32	59	145,50	1	006420027
28	66	32	64	145,50	1	006420028
30	66	32	66	145,50	1	006420030
32	67	32	66	145,50	1	006420032
* 36	76	42	80	206,50	1	006420036
* 40	77	52	95	206,50	1	006420040
* 41	78	52	95	206,50	1	006420041
* 46	90	52	95	242,50	1	006420046

*Opgelet! Herbereken de torsiewaarde volgens de tabel als afgebeeld aan het einde van de prijslijst.

643

Insteek steeksleutels voor momnetsleutels, rechthoekige aansluiting

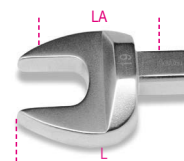

mm	mm	L mm	LA mm	€		
7	9x12	37	28,8	56,00	1	006430007
8	9x12	37	28,8	56,00	1	006430008
10	9x12	39	28,8	56,00	1	006430010
12	9x12	39	28,8	56,00	1	006430012
13	9x12	39	28,8	56,00	1	006430013
14	9x12	43	28,8	57,00	1	006430014
15	9x12	43	28,8	57,00	1	006430015
16	9x12	43	28,8	57,00	1	006430016
17	9x12	43	28,8	57,00	1	006430017
* 18	9x12	47	36,3	57,00	1	006430018
* 19	9x12	51	36,3	57,00	1	006430019
* 21	9x12	52	36,3	90,00	1	006430021
* 22	9x12	52	36,3	90,00	1	006430022

*Opgelet! Herbereken de torsiewaarde volgens de tabel als afgebeeld aan het einde van de prijslijst.

mm	mm	L mm	LA mm	€		
13	14x18	60	39,8	59,50	1	006430113
14	14x18	58	39,8	59,50	1	006430114
15	14x18	60	39,8	59,50	1	006430115
16	14x18	60	39,8	62,00	1	006430116
17	14x18	60	39,8	62,00	1	006430117
18	14x18	61	39,8	62,00	1	006430118
19	14x18	61	39,8	62,00	1	006430119
21	14x18	61	39,8	94,50	1	006430121
22	14x18	62	39,8	94,50	1	006430122
24	14x18	64	39,8	94,50	1	006430124
* 27	14x18	68	44,8	106,50	1	006430127
* 30	14x18	77	49,8	111,00	1	006430130
* 32	14x18	77	49,8	111,00	1	006430132
* 34	14x18	80	54,8	172,00	1	006430134
* 36	14x18	83	54,8	172,00	1	006430136
* 38	14x18	83	54,8	172,00	1	006430138
* 41	14x18	91	64,8	172,00	1	006430141

*Opgelet! Herbereken de torsiewaarde volgens de tabel als afgebeeld aan het einde van de prijslijst.

644

Opsteek steeksleutels voor opsteekmomnetsleutels, ronde aansluiting, Ø 22 mm



mm	L mm	LA mm	A mm	€		
22	91	56	52	121,50	1	006440022
24	91	56	52	121,50	1	006440024
27	94	56	64	145,50	1	006440027
30	94	56	64	145,50	1	006440030
32	97	56	75,5	145,50	1	006440032
34	97	56	75,5	145,50	1	006440034
36	97	56	75,5	206,50	1	006440036
41	103,5	56	94	206,50	1	006440041
46	115,5	56	94	242,50	1	006440046

650A

Verstelbare sleutels voor momentsleutels, rechthoekig aansluiting



A min-max mm	mm	L mm	LA mm	€		
* 5-27	9X12	93	74,3	108,50	1	006500027
* 5-30	9X12	106	85,3	108,50	1	006500030
* 5-30	14X18	115	89	111,00	1	006500130
* 10-41	14X18	127	100	114,50	1	006500141

*Opgelet! Herbereken de torsiewaarde volgens de tabel als afgebeeld aan het einde van de prijslijst.

650H

Haaksleutels voor momentsleutels, rechthoekige aansluiting



mm	mm	L mm	LA mm	€		
* 28-36	14x18	122	92	57,00	1	006500928
* 40-45	14x18	129	92	57,00	1	006500940
* 50-55	14x18	129	92	57,00	1	006500950
* 58-62	14x18	135	92	60,50	1	006500958
* 68-75	14x18	139	92	67,00	1	006500968
* 80-90	14x18	145	92	67,00	1	006500980

*Opgelet! Herbereken de torsiewaarde volgens de tabel als afgebeeld aan het einde van de prijslijst.

652

Opsteek ringsleutel voor momentsleutels



mm	L mm	LA mm	€		
8	58	32	74,00	1	006520008
10	58	32	74,00	1	006520010
12	58	32	74,00	1	006520012
13	58	32	74,00	1	006520013
14	58	32	74,00	1	006520014
15	62	32	74,00	1	006520015
16	63	32	74,00	1	006520016
17	64	32	74,00	1	006520017
18	65	32	74,00	1	006520018
19	65	32	74,00	1	006520019
21	67	32	113,50	1	006520021
22	68	32	117,50	1	006520022
24	69	32	147,50	1	006520024
26	71	32	157,00	1	006520026
27	71	32	157,00	1	006520027
30	73	32	157,00	1	006520030
32	74	32	157,00	1	006520032

653

Insteek ringsleutels voor momentsleutels, rechthoekige aansluiting



mm	mm	L mm	LA mm	€		
7	9X12	40	28,8	60,50	1	006530007
8	9x12	40	28,8	60,50	1	006530008
10	9x12	43	28,8	60,50	1	006530010
12	9x12	44	28,8	60,50	1	006530012
13	9x12	44	28,8	60,50	1	006530013
14	9x12	45	28,8	60,50	1	006530014
15	9x12	46	28,8	60,50	1	006530015
16	9x12	47	28,8	62,00	1	006530016
17	9x12	47	28,8	62,00	1	006530017
18	9x12	48	28,8	62,00	1	006530018
19	9x12	49	28,8	62,00	1	006530019
21	9X12	51	28,8	65,00	1	006530021
22	9x12	51	28,8	65,00	1	006530022

mm	mm	L mm	LA mm	€		
13	14x18	61	39,8	66,50	1	006530113
14	14x18	61	39,8	66,50	1	006530114
15	14x18	62	39,8	66,50	1	006530115
16	14x18	63	39,8	69,00	1	006530116
17	14x18	64	39,8	69,00	1	006530117
18	14x18	64	39,8	69,00	1	006530118
19	14x18	66	39,8	69,00	1	006530119
21	14x18	66	39,8	95,50	1	006530121
22	14x18	67	39,8	95,50	1	006530122
24	14x18	69	39,8	122,00	1	006530124
* 27	14x18	76	44,8	122,00	1	006530127
* 30	14x18	77	44,8	122,00	1	006530130
* 32	14x18	79	44,8	122,00	1	006530132
* 34	14x18	80	44,8	172,50	1	006530134
* 36	14x18	80	44,8	172,50	1	006530136
* 38	14X18	90	49,8	175,50	1	006530138
* 41	14x18	90	49,8	175,50	1	006530141

*Opgelet! Herbereken de torsiewaarde volgens de tabel als afgebeeld aan het einde van de prijslijst.

654

Opsteek ringsleutels voor opsteekmomentsleutel, ronde aansluiting, Ø 22 mm



mm	L mm	LA mm	A mm	€		
22	98,5	56	38	117,50	1	006540022
24	98,5	56	38	147,50	1	006540024
27	102,8	56	46,5	157,00	1	006540027
30	102,8	56	46,5	157,00	1	006540030
32	106,5	56	55	157,00	1	006540032
34	106,5	56	55	157,00	1	006540034
36	106,5	56	55	203,50	1	006540036
41	115,5	56	72	203,50	1	006540041
46	115,5	56	72	210,50	1	006540046

659/15

Adapter met rechthoekige insteek van (14x18 mm) en aandrijf van (9x12 mm)



mm	mm	mm	LA mm	€		
* 56	14x18	9x12	39	91,00	1	006590815

*Opgelet! Herbereken de torsiewaarde volgens de tabel als afgebeeld aan het einde van de prijslijst.



Altijd het toegestane koppel volgen en gelijkmatig en progressief aantrekken om het breken en eventuele verwondingen te voorkomen.

659/16

adapter met rechthoekige insteek van (9x12 mm) en aandrijf van (14x18 mm)



L mm	mm	mm	LA mm	€		
* 52	9x12	14x18	31	78,50	1	006590816

*Opgelet! Herbereken de torsiewaarde volgens de tabel als afgebeeld aan het einde van de prijslijst.

665

Mechanische momentsleutel met digitale instelling en omschakelbare ratel, voor rechtsom vastdraaien, torsie nauwkeurigheid ± 3%

- Automatische uitschakeling na 10 seconden onder het minimum ingestelde koppel.
- Scherm zal het ingestelde koppel behouden.
- Aanhaalkoppel uitleesbaar tot 0.1%
- Voeding: 1 3V batterij (meegeleverd)



UNI EN ISO 6789

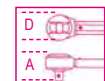

Nm	mm	D mm	A mm	L mm	g	mm
10=60	3/8	30	33	335	655	0,1

€		
665/6	277,00	1 006650006

Nm	mm	D mm	A mm	L mm	g	mm
20=100	3/8	30	33	375	725	0,1

€		
665/10	280,00	1 006650010

Nm	mm	D mm	A mm	L mm	g	mm
20=100	1/2	30	37	375	725	0,1

€		
665/10X	284,00	1 006650011

Nm	mm	D mm	A mm	L mm	g	mm
40=200	1/2	40	43	470	995	0,5

€		
665/20	308,00	1 006650020

Nm	mm	D mm	A mm	L mm	g	mm
60=330	1/2	40	43	590	1260	0,5

€		
665/30	350,00	1 006650030

665LB

Mechanische momentsleutel met digitale uitlezing, omschakelbare ratel voor het rechtsom vastdraaien, torsie nauwkeurigheid: $\pm 3\%$

- Weergave van eenheid in: lbf.ft
- Torsie is eenvoudig in te stellen doordat de waarde zichtbaar zijn op het scherm
- Het scherm blijft de ingestelde waarde tonen
- Torsie uitlezing tot 0.1 mm
- Automatische uitschakeling na 30 sec. onder het minimum in te stellen koppel • Voeding: 1 3V batterij (meegeleverd)



UNI EN ISO 6789

lbf.ft	D	A	L	g	
7÷45	3/8	mm 30	mm 33	mm 335	655
					0,1

665LB/6 € 277,00 1 006650106

lbf.ft	D	A	L	g	
15÷75	3/8	mm 30	mm 33	mm 375	725
					0,1

665LB/10 € 280,00 1 006650110

lbf.ft	D	A	L	g	
15÷75	1/2	mm 30	mm 37	mm 375	725
					0,1

665LB/10X € 284,00 1 006650111

lbf.ft	D	A	L	g	
30÷150	1/2	mm 40	mm 43	mm 470	995
					0,5

665LB/20 € 308,00 1 006650120

lbf.ft	D	A	L	g	
45÷240	1/2	mm 40	mm 43	mm 590	1260
					0,5

665LB/30 € 350,00 1 006650130

665SW

Kalibratie apparaat

- Het apparaat kalibreert de momentsleutels 665 met behulp van de moment meters 680 en 682, zonder deze te moeten demonteren.
- Kalibratie wordt uitgevoerd op diverse punten om het niet lineaire gedrag van de veer te compenseren.
- Voorzien van een micro USB aansluiting, voor het maken van updates.



665SW € 29,00 1 006650100

666-667 ZERO-RESET

DE NIEUWE MOMENTSLEUTEL DIE NIET TERUGGESTELD HOEFT TE WORDEN.

Zelfs als de spanning niet wordt opgeheven, zijn het aantal cycli, de duurzaamheid en de aanhaalnauwkeurigheid zoals vereist door referentienormen gegarandeerd.

Om deze parameters te bevestigen, voerde de Research & Development-afdeling van Beta Utensili talrijke duurtesten uit in de eigen laboratoria en bij honderden eindgebruikers.

Dit resultaat is tot stand gekomen door:

- het gebruik van de best presterende momenteel beschikbare materialen;
- speciale hittebehandeling op de inwendige onderdelen.

100% MADE-IN-ITALY

De Zero Reset Momentsleutel is volledig in eigen huis ontworpen en ontwikkeld en wordt vervaardigd in de fabrieken van Beta Utensili in Italië, met 100% Italiaanse onderdelen.

Op basis van de nieuwe onderdelen hoeft de sleutel niet meer teruggezet te worden naar de minimale waarde aan het einde aan de gebruikscyclus.

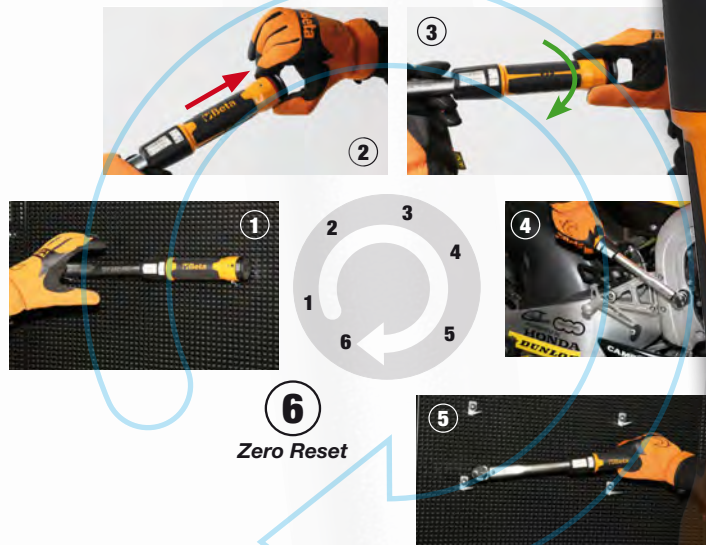

666

ZERO-RESET momentsleutel met klikmechanisme en omschakelbare ratel. Voor rechtsom vastdraaien met torsienauwkeurigheid van $\pm 3\%$

- Handmatige reset naar nul niet nodig



UNI EN ISO 6789

Nm	■	D mm	A mm	L mm	g	⚙️
5÷25	1/4	26	25	273	395	0,05

666/2	260,00	1	006660702
--------------	---------------	----------	------------------

Nm	■	D mm	A mm	L mm	g	⚙️
5÷25	3/8	26	29	273	405	0,05

666/2X	260,00	1	006660703
---------------	---------------	----------	------------------

Nm	■	D mm	A mm	L mm	g	⚙️
10÷50	3/8	30	33	342	680	0,25

666/5	240,00	1	006660705
--------------	---------------	----------	------------------

Nm	■	D mm	A mm	L mm	g	⚙️
20÷100	3/8	30	33	385	760	0,25

666/10	245,00	1	006660710
---------------	---------------	----------	------------------

Nm	■	D mm	A mm	L mm	g	⚙️
20÷100	1/2	30	37	385	770	0,25

666/10X	255,00	1	006660711
----------------	---------------	----------	------------------

Nm	■	D mm	A mm	L mm	g	⚙️
40÷200	1/2	42	43	471	1020	0,5

666/20	265,00	1	006660720
---------------	---------------	----------	------------------

Nm	■	D mm	A mm	L mm	g	⚙️
60÷300	1/2	42	43	600	1270	1,0

666/30	300,00	1	006660730
---------------	---------------	----------	------------------

666 LBF.FT

ZERO-RESET momentsleutel met klikmechanisme en omschakelbare ratel. Voor rechtsom vastdraaien met torsienauwkeurigheid van $\pm 3\%$

- Handmatige reset naar nul niet nodig
- Schaaf in lbf.ft



UNI EN ISO 6789

lbf.ft	■	D mm	A mm	L mm	g	⚙️
4÷18	1/4	26	25	273	395	0,05

666 LBF.FT/2	260,00	1	006660762
---------------------	---------------	----------	------------------

lbf.ft	■	D mm	A mm	L mm	g	⚙️
4÷18	3/8	26	29	273	405	0,05

666 LBF.FT/2X	260,00	1	006660763
----------------------	---------------	----------	------------------

lbf.ft	■	D mm	A mm	L mm	g	⚙️
7÷37	3/8	30	33	342	680	0,25

666 LBF.FT/5	240,00	1	006660765
---------------------	---------------	----------	------------------

lbf.ft	■	D mm	A mm	L mm	g	⚙️
15÷75	3/8	30	33	385	760	0,25

666 LBF.FT/10	242,00	1	006660780
----------------------	---------------	----------	------------------

lbf.ft	■	D mm	A mm	L mm	g	⚙️
15÷75	1/2	30	37	385	770	0,25

666 LBF.FT/10X	255,00	1	006660781
-----------------------	---------------	----------	------------------

lbf.ft	■	D mm	A mm	L mm	g	⚙️
30÷150	1/2	42	43	471	1020	0,5

666 LBF.FT/20	259,00	1	006660782
----------------------	---------------	----------	------------------

lbf.ft	■	D mm	A mm	L mm	g	⚙️
50÷230	1/2	42	43	600	1270	1,0

666 LBF.FT/30	294,00	1	006660783
----------------------	---------------	----------	------------------

667

ZERO-RESET klik-momentsleutels met doorsteekratels, voor rechts/links vastdraaien, koppelnaauwkeurigheid: $\pm 3\%$

- Vereist geen loslaten van spanning



UNI EN ISO 6789

Nm	■	D mm	A mm	L mm	g	⚙️
40÷200	1/2	42	42	471	1035	0,5

667/20	285,00	1	006670720
---------------	---------------	----------	------------------

Nm	■	D mm	A mm	L mm	g	⚙️
60÷300	1/2	42	42	600	1285	1,0

667/30	315,00	1	006670730
---------------	---------------	----------	------------------

Nm	■	D mm	A mm	L mm	g	⚙️
80÷400	3/4	59	53	710	2220	1,0

667/40	670,00	1	006670740
---------------	---------------	----------	------------------

Zie de tabel na item 929/C8 voor de draaiende onderdelen van het ratelmechanisme

668N

Momentsleutels met klikmechanisme voor het links- en rechtsom vastdraaien, Torsie nauwkeurigheid: $\pm 3\%$



UNI EN ISO 6789

Nm	Kgfm	lbf.ft	Ø mm	L mm	LB mm	LS mm	g	⚙️
5÷25	0,5÷2,5	4÷18	16	220	148	32	300	0,2

668N/2	299,00	1	006680002
---------------	---------------	----------	------------------

Nm	Kgfm	lbf.ft	Ø mm	L mm	LB mm	LS mm	g	⚙️
10÷50	1÷5	7÷37	16	307	229	32	590	0,5

668N/5	290,00	1	006680005
---------------	---------------	----------	------------------

Nm	Kgfm	lbf.ft	Ø mm	L mm	LB mm	LS mm	g	⚙️
20÷100	2÷10	15÷75	16	376	269	32	670	1,0

668N/10	299,00	1	006680010
----------------	---------------	----------	------------------

Nm	Kgfm	lbf.ft	Ø mm	L mm	LB mm	LS mm	g	⚙️
40÷200	4÷20	30÷150	16	450	352,6	32	795	2,0

668N/20	319,00	1	006680020
----------------	---------------	----------	------------------

Nm	Kgfm	lbf.ft	Ø mm	L mm	LB mm	LS mm	g	⚙️
60÷300	6÷30	50÷220	16	588	475,9	32	1230	2,0

668N/30	361,00	1	006680030
----------------	---------------	----------	------------------



668RG

klik-type momentsleutel, niet gegradeerd, voor rechts- en linksdraaiend koppelnauwkeurigheid: $\pm 4\%$ (te gebruiken met artikelen 680 - 682)



UNI EN ISO 6789

Nm	Kgfm	lbf.ft	Ø mm	L mm	g
8÷60	0,8÷6	6÷44	16	288	550

668RG/6	€ 227,50	1	006680206
----------------	-----------------	----------	------------------

Nm	Kgfm	lbf.ft	Ø mm	L mm	g
20÷100	2÷10	15÷80	16	315	600

668RG/10	€ 239,50	1	006680210
-----------------	-----------------	----------	------------------

Nm	Kgfm	lbf.ft	Ø mm	L mm	g
40÷200	4÷20	30÷150	16	405	780

668RG/20	€ 251,00	1	006680220
-----------------	-----------------	----------	------------------

Nm	Kgfm	lbf.ft	Ø mm	L mm	g
60÷300	6÷30	50÷220	16	645	1130

668RG/30	€ 285,00	1	006680230
-----------------	-----------------	----------	------------------

668RGC

klik-momentsleutel, niet gegradeerd, met omkeerbare ratel, voor rechts aandraaien, koppelnauwkeurigheid: $\pm 4\%$ (voor gebruik met artikelen 680 - 682)



UNI EN ISO 6789

Nm	Kgfm	lbf.in	■ mm	D mm	A mm	L mm	g
12÷60	1,2÷6	5÷45	3/8	30	33	295	600

668RGC/6	€ 202,50	1	006680406
-----------------	-----------------	----------	------------------

Nm	Kgfm	lbf.in	■ mm	D mm	A mm	L mm	g
20÷100	2÷10	15÷75	3/8	30	33	335	700

668RGC/10	€ 211,50	1	006680410
------------------	-----------------	----------	------------------

Nm	Kgfm	lbf.in	■ mm	D mm	A mm	L mm	g
20÷100	2÷10	15÷75	1/2	40	43	342	700

668RGC/10X	€ 211,50	1	006680411
-------------------	-----------------	----------	------------------

Nm	Kgfm	lbf.in	■ mm	D mm	A mm	L mm	g
40÷200	4÷20	30÷150	1/2	40	43	425	1000

668RGC/20	€ 215,50	1	006680420
------------------	-----------------	----------	------------------

669N

Momentsleutel met klikmechanisme en aandrijfvierkant voor links-en rechtsom vastdraaien koppelnauwkeurigheid: $\pm 3\%$



UNI EN ISO 6789

Nm	Kgfm	lbf.ft	□ mm	L mm	LB mm	LS mm	g
5÷25	0,5÷2,5	4÷18	9x12	215	140	28,8	300

669N/2	€ 418,00	1	006690202
---------------	-----------------	----------	------------------

Nm	Kgfm	lbf.ft	□ mm	L mm	LB mm	LS mm	g
10÷50	1÷5	7÷37	9x12	307	226,8	28,8	590

669N/5	€ 312,00	1	006690205
---------------	-----------------	----------	------------------

Nm	Kgfm	lbf.ft	□ mm	L mm	LB mm	LS mm	g
20÷100	2÷10	15÷75	9x12	376	266,8	28,8	670

669N/10	€ 338,00	1	006690210
----------------	-----------------	----------	------------------

Nm	Kgfm	lbf.ft	□ mm	L mm	LB mm	LS mm	g
40÷200	4÷20	30÷150	9x12	450	345,6	28,8	795

669N/20	€ 404,00	1	006690220
----------------	-----------------	----------	------------------

Nm	Kgfm	lbf.ft	□ mm	L mm	LB mm	LS mm	g
40÷200	4÷20	30÷150	14x18	450	351	39,8	795

669N/20X	€ 424,00	1	006690221
-----------------	-----------------	----------	------------------

Nm	Kgfm	lbf.ft	□ mm	L mm	LB mm	LS mm	g
60÷300	6÷30	50÷220	14x18	588	468,5	39,8	1230

669N/30	€ 446,00	1	006690230
----------------	-----------------	----------	------------------

Nm	Kgfm	lbf.ft	□ mm	L mm	LB mm	LS mm	g
80÷400	8÷40	60÷295	14x18	664	563	39,8	2100

669N/40	€ 513,00	1	006690240
----------------	-----------------	----------	------------------



671B/C5

Momentsleutel artikel 604B/5 en toebehoren



671B/C5	€ 1.147,00	1	006710001
----------------	-------------------	----------	------------------

604B/5	1÷5 Nm
611	1/4
641	5-6-7-8 mm
900	4-5-5,5-6-7-8-9-10 mm

270x120x45 mm - 1,3 kg

671B/C10

Momentsleutel artikel 604B/10 en toebehoren



671B/C10	€ 1.147,00	1	006710002
-----------------	-------------------	----------	------------------

604B/10	2÷10 Nm
611	1/4
641	6-7-8-10 mm
900	4-5-5,5-6-7-8-9-10 mm

270x120x45 mm - 1,4 kg

671N/C10

Momentsleutels 668N/10 met toebehoren



671N/C10	€ 1.285,00	1	006710110
-----------------	-------------------	----------	------------------

668N/10	100 Nm
612	■ 3/8
617	■ 3/8
642	10-13-14-17-19 mm
652	10-13-14-17-19 mm
910A	□ 3/8 8-10-11-13-14-17-19 mm
910/21	125 mm
910/22	250 mm

400x180x45 mm - 4,3 kg

671N/C20

Momentsleutels 668N/20 met toebehoren

12" 



671N/C20 1.355,00 €  1 006710120

668N/20	200 Nm
614	■ 1/2
619	■ 1/2
642	10-13-14-17-19 mm
652	10-13-14-17-19 mm
○ 920A	□ 1/2 10-11-13-14-17-19-22 mm
920/20	75 mm
920/21	125 mm
920/22	255 mm

510x180x45 mm -  5,5 kg

671N/C30

Momentsleutels 668N/30 met toebehoren

12" 



671N/C30 1.275,00 €  1 006710130

668N/30	300 Nm
614	■ 1/2
619	■ 1/2
642	13-14-17-19 mm
652	13-14-17-19 mm
○ 920A	□ 1/2 13-14-17-19-22-24-27 mm
920/20	75 mm
920/21	125 mm
920/22	255 mm

620x180x45 mm -  5,8 kg

Beta

674/C

Momentsleutels met klik mechanisme, opzet aansluiting Ø 22 mm, voor rechts en linksom vastzetten, torsie nauwkeurigheid ± 4%, in koffer

22" 



UNI EN ISO 6789

Nm	Kgfm	lbf.ft	Ø	L	LB	LS	kg	mm
100÷500	10÷50	80÷400	22	786	725	56	3,4	1,25

674/C50 903,00 €  1 006740005

Nm	Kgfm	lbf.ft	Ø	L	LB	LS	kg	mm
160÷800	16÷80	120÷600	22	997	915	56	4,5	2,0

674/C80 944,00 €  1 006740008

Nm	Kgfm	lbf.ft	Ø	L	LB	LS	kg	mm
200÷1000	20÷100	150÷750	22	997	915	56	4,5	2,5

674/C100 957,00 €  1 006740010

677

Momentsleutels met klikmechanisme met doordruk ratel, voor het links- en rechtsom vastdraaien, Torsie nauwkeurigheid: ±4%

3/4" 

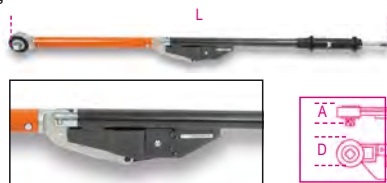

UNI EN ISO 6789

Nm	Kgfm	lbf.ft	D	A	L	kg	mm
120÷600	12÷60	100÷450	69	55	1059	6,0	10

677/600 1.048,00 €  1 006770006

Nm	Kgfm	lbf.ft	D	A	L	kg	mm
200÷800	20÷80	150÷600	69	55	1319	6,7	10

677/800 1.098,00 €  1 006770008

Nm	Kgfm	lbf.ft	D	A	L	kg	mm
300÷1000	30÷100	200÷750	69	55	1554	7,4	20

677/1000 1.179,00 €  1 006770010

677/C

Momentsleutel met knikmechanisme en doordrukratel voor zowel rechts als linksom vastdraaien. Torsie nauwkeurigheid: ± 4% in koffer

3/4" 

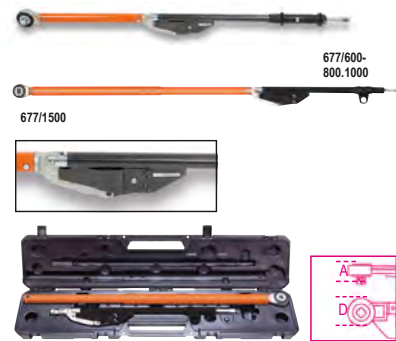

UNI EN ISO 6789

Nm	Kgfm	lbf.ft	D	A	L	kg	mm
120÷600	12÷60	100÷450	69	55	1059	6,0	10

677/C600 1.235,00 €  1 006770607

Nm	Kgfm	lbf.ft	D	A	L	kg	mm
200÷800	20÷80	150÷600	69	55	1319	6,7	10

677/C800 1.285,00 €  1 006770612

Nm	Kgfm	lbf.ft	D	A	L	kg	mm
300÷1000	30÷100	200÷750	69	55	1554	7,4	20

677/C1000 1.370,00 €  1 006770616

Nm	Kgfm	lbf.ft	D	A	L	kg	mm
700÷1500	70÷150	500÷1000	69	55	1869	9,6	25

677/C1500 1.750,00 €  1 006770621

677/CP2000

Momentsleutel met knik-mechanisme met doorsteekratel, voor rechts en links vastdraaien, koppel nauwkeurigheid: ± 4% in koffer

1" 



UNI EN ISO 6789

Nm	Kgfm	lbf.ft	D	A	L	kg	mm
900÷2000	90÷200	700÷1500	69	63	1940	12,75	50

677/CP2000 3.210,00 €  1 006770721

Beta

Beta

Quality Tools

Beta

678/C

Momentsleutels met klik mechanisme en doordruk ratel voor zowel rechts als linksom vastdraaien, Torsie nauwkeurigheid: $\pm 4\%$ in koffer

• De modellen 678/C100 en 678/C150 worden compleet geleverd met handgreepverlenging

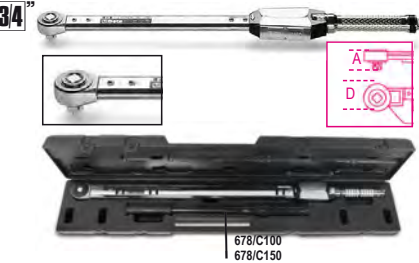

UNI EN ISO 6789

Nm	Kgfm	lbf.ft	D	A	L	kg	mm
130÷650	13÷65	100÷480	63	55	885	3,9	5,0

678/C65	1.995,00	1	006780607
----------------	-----------------	---	-----------

Nm	Kgfm	lbf.ft	D	A	L	kg	mm
300÷1000	30÷100	220÷750	75	60	1250	6,0	10

678/C100	2.660,00	1	006780611
-----------------	-----------------	---	-----------

Nm	Kgfm	lbf.ft	D	A	L	kg	mm
500÷1500	50÷150	370÷1100	75	60	1570	8,5	10

678/C150	2.830,00	1	006780615
-----------------	-----------------	---	-----------

677/CV - 678/CV

Kunststof koffer voor momentsleutels artikel 677 en 678



677/CVN1	189,50	1	006770455
-----------------	---------------	---	-----------

677/CVN2	248,50	1	006770460
-----------------	---------------	---	-----------

678/CV1	180,00	1	006780455
----------------	---------------	---	-----------

678/CV2	194,50	1	006780500
----------------	---------------	---	-----------

678/CV3	319,00	1	006780415
----------------	---------------	---	-----------

677/C100-677/C150-678/C150			
-----------------------------------	--	--	--

680

elektronische digitale koppelmeter Dynatester 680 voor het testen en calibreren rechtsom/linksom draaiend

- Nauwkeurigheid: $\pm 1\%$ van leeswaarde
- LCD-kleurendisplay, 4 cijfers
- 3 meeteenheden: Nm - lbf.ft. - lbf.in



	Nm	kg	€	1	006800000
680/3	0,1÷3	1,4	3.220,00	1	006800000
680/30	1,5÷30	1,4	3.170,00	1	006800003
680/350	10÷350	2,6	3.180,00	1	006800035
680/2100	200÷2100	3,5	4.730,00	1	006800210

682

Electronische en digitale momentmeter. Dynatester 682 zowel links al rechtsom te gebruiken. Opmerkelijk nauwkeurige uitlezing. Geleverd met serial uitgang RS 232.



TECHNISCHE KENMERKEN:
Nauwkeurigheid
 +/- 1% van de afgelezen waarde
Eenheid te veranderen in
 Nm-dNm-cNm-lbf.ft-lbf.in-Ozf.in-Kgf.m-Kgf.cm-gt.cm
Aansluiting 90 tot 264 V AC 50/60 Hz
Afmetingen 235x185x185 mm
Tolerantie test conform de normen ISO 6789
 Meetwaarden afwijking en tolerantie voor elke gesteste momentsleutel
Display Menu is beschikbaar in 11 talen
Geleverd met alle benodigde certificaten
 Kalibratie certificaat met UKAS oorkomst

	Nm	kg	€	1	006820006
682/60	1,2÷60	5,9	6.440,00	1	006820006
682/400	8÷400	6,1	6.560,00	1	006820040
682/1500	30÷1500	6,4	6.880,00	1	006820150

SLAGDOPPEN



Slagdoppen hebben grotere afmetingen in vergelijking met handdoppen, zodat ze een hoog koppel kunnen absorberen zoals ontwikkeld door slagmoersleutels en krachtvermeerderaars.

Het nieuwe 12-kant profiel zorgt voor een snelle passing.

Naast de klassieke modellen in de standaard, lange en dunne serie is ook het **nieuwe XZN® profiel** leverbaar; bovendien is het assortiment van accessoires voor slagdoppen uitgebreid.



710

Slagdoppen, standaard modellen



UNI/ISO 2725 DIN 3129

Ø mm	Ø mm	L mm	Ø1 mm	€	QTY	Part No.
7	12,5	28	19	9,25	3	007100007
8	13,8	28	19	9,25	3	007100008
9	15,0	28	19	9,25	3	007100009
10	16,3	28	19	9,25	3	007100010
11	17,5	30	19	9,25	3	007100011
12	19,0	30	19	9,25	3	007100012
13	20,0	30	22	10,10	3	007100013
14	21,3	30	22	10,10	3	007100014
16	23,8	30	22	10,10	3	007100016
17	25,0	30	22	10,10	3	007100017
18	26,3	30	22	10,30	3	007100018
19	27,5	30	22	10,30	3	007100019
21	30,0	32	22	11,00	3	007100021
22	32,0	32	22	12,70	3	007100022

710/C10

10-delig set 3/8" slagdoppen



710/C10 130,50 1 007100910

7-8-10-11-12-13
14-17-19-22 mm

130x55x40 mm - 800 g

710/16

Verlooptop 3/8" naar 1/2"



L mm Ø mm 3/8 1/2 € QTY Part No.
32 22 26,00 3 007100810

710/20

3/8" verlengstukken



L mm Ø mm € QTY Part No.
75 22 26,50 2 007100821

710/21

3/8" verlengstukken



L mm Ø mm € QTY Part No.
125 22 29,00 2 007100823

710/22

slagverlengstuk, 3/8" aansluiting



L mm Ø mm € QTY Part No.
150 22 34,00 2 007100825

710/25

3/8" cardangewricht



L mm Ø mm € QTY Part No.
58 24 53,50 2 007100830

710/OR... - 710/SP...

Rubber O ringen en borgstiften



710	710/16	€	QTY	Part No.
Ø mm	L mm			
710/OR1	7-12	0,80	10	007100921
710/OR2	13-22	0,80	10	007100922
710/SP1	7-12	1,55	10	007100911
710/SP2	13-22	1,55	10	007100912

720

Slagdoppen, standaard modellen



UNI/ISO 2725 DIN 3129

Ø mm	Ø mm	L mm	Ø1 mm	€	QTY	Part No.
8	15,0	38	25	11,80	5	007200008
9	16,0	38	25	11,80	5	007200009
10	17,0	38	25	11,80	5	007200010
11	18,5	38	25	11,80	5	007200011
12	20,0	38	25	11,90	5	007200012
13	21,0	38	25	11,90	5	007200013
14	22,5	38	25	11,90	5	007200014
15	23,0	38	30	13,20	5	007200015
16	25,0	38	30	13,20	5	007200016
17	26,0	38	30	13,20	5	007200017
18	27,5	38	30	13,20	5	007200018
19	28,5	38	30	13,20	5	007200019
20	30	38	30	14,80	5	007200020
21	31,0	38	30	14,80	5	007200021
22	32,5	38	30	15,00	5	007200022
23	34,0	38	30	16,30	5	007200023
24	35,0	38	30	16,30	5	007200024
27	38,5	45	30	19,80	3	007200027
29	41	47	30	20,80	3	007200029
30	42,0	50	30	21,50	3	007200030
32	44,0	50	30	24,50	3	007200032
36	50,0	50	30	34,00	3	007200036

720/C6

Slagdoppen



720/C6 106,50 1 007200910

13-14-17-19-22-24 mm

195x80x55 mm - 1100 g

720/C12

Slagdoppen



720/C12 208,00 1 007200912

10-11-12-13-14-17
19-22-24-27-30-32 mm

195x80x55 mm - 2000 g

720/C24

24 Slagdoppen



720/C24 € 473,00 1 007200904

- 720 10 - 12 - 13 - 14 - 15 - 16 - 17 - 18 - 19 - 21 - 22 - 24 - 27 - 30 - 32 mm
- 720L 13 - 17 - 19 - 21 - 22 - 24 mm
- 720LC 17 - 19 - 21 mm

420x185x60 mm - 6,2 kg

720MC

Slagdoppen, standaard uitvoering, gekleurd



Ø	mm	L	mm	€		
10	17,0	38		12,30	3	007202010
11	18,5	38		12,30	3	007202011
12	20,0	38		12,30	3	007202012
13	21,0	38		12,30	3	007202013
14	22,5	38		12,30	3	007202014
15	23,0	38		13,70	3	007202015
16	25,0	38		13,70	3	007202016
17	26,0	38		13,70	3	007202017
18	27,5	38		13,70	3	007202018
19	28,5	38		13,70	3	007202019
21	31,0	38		15,30	2	007202021
22	32,5	38		15,30	2	007202022
24	35,0	38		16,80	2	007202024

720MC/C13

13 slagdoppen, gekleurd



720MC/C13 € 222,00 1 007202913

10-11-12-13-14-15
16-17-18-19-21-22
24 mm

335x145x60 mm - 2,4 kg

720B

Slagdoppen twaalfkant



UNI/ISO 2725 DIN 3129

Ø	mm	L	mm	Ø1	mm	€		
10	17	38	25		12,00	5	007201010	
11	18	38	25		12,00	5	007201011	
12	19	38	25		12,00	5	007201012	
13	20	38	25		12,00	5	007201013	
14	22	38	25		12,00	5	007201014	
15	23	38	30		13,40	5	007201015	
16	24	38	30		13,40	5	007201016	
17	26	38	30		13,40	5	007201017	
18	27	38	30		13,40	5	007201018	
19	28	38	30		13,40	5	007201019	
21	30	38	30		14,80	5	007201021	
22	31,8	38	30		15,00	5	007201022	
23	31,8	38	30		16,30	5	007201023	
24	33,8	40	30		16,30	5	007201024	
27	37,8	43	30		19,00	3	007201027	
30	41,8	43	30		20,80	3	007201030	
32	43,8	43	30		23,70	3	007201032	
36	49,8	50	30		34,00	3	007201036	

720B/C12

12 slagdoppen twaalfkant



UNI/ISO 2725 DIN 3129

720B/C12 € 206,50 1 007201912

10-11-12-13-14-17
19-22-24-27-30-32 mm

195x80x55 mm - 2000 g

720AS

Slagdrop standaard model



Ø	mm	L	mm	Ø1	mm	€		
3/8	17,0	38	25		19,40	2	007200210	
7/16	18,2	38	25		19,40	2	007200211	
1/2	20,7	38	25		19,40	2	007200213	
9/16	22,0	38	25		19,40	2	007200214	
5/8	24,5	38	30		20,80	2	007200216	
11/16	25,7	38	30		20,80	2	007200217	
3/4	28,2	38	30		20,80	2	007200219	
13/16	30,7	38	30		22,40	2	007200221	
7/8	32,0	38	30		22,40	2	007200222	
15/16	34,5	38	30		23,70	2	007200224	
1	35,7	38	30		25,50	2	007200225	
1.1/16	38,2	40	30		27,50	1	007200227	
1.1/8	40,7	42	30		31,50	1	007200229	
1.1/4	44,5	42	30		35,00	1	007200232	

720S

Slagdoppen, compacte uitvoering



Ø	mm	L	mm	Ø1	mm	€		
13	20,0	28,0	23,8		7,65	3	007200113	
15	23,0	28,0	23,8		7,65	3	007200115	
17	25,8	28,0	25,8		8,10	3	007200117	
19	27,8	28,0	27,8		9,20	3	007200119	
22	31,8	28,0	30,0		10,20	3	007200122	
24	33,8	28,0	30,0		11,00	3	007200124	



720S/SB6 € 66,50 1 007200906

13-15-17-19-22-24 mm

720L

Slagdoppen, lange modellen



UNI/ISO 2725

Ø	mm	L	mm	Ø1	mm	€		
10	17,0	80	25		20,40	2	007200310	
11	18,5	80	25		20,40	2	007200311	
12	20,0	80	25		20,40	2	007200312	
13	21,0	80	25		20,40	2	007200313	
14	22,5	80	25		20,40	2	007200314	
15	23,0	80	30		22,80	2	007200315	
16	25,0	80	30		22,80	2	007200316	
17	26,0	80	30		22,80	2	007200317	
18	27,5	80	30		24,20	2	007200318	
19	28,5	80	30		24,20	2	007200319	
21	31,0	80	30		26,00	2	007200321	
22	32,5	80	30		26,00	2	007200322	
24	35,0	80	30		27,00	2	007200324	
27	38,5	80	30		33,50	2	007200327	
30	42,0	80	30		42,00	2	007200330	
32	44,0	80	30		42,00	2	007200332	
36	50,0	80	30		54,00	2	007200336	

720L/S3

3-delig set slagdoppen 720L



720L/S3 € 73,00 1 007200355

17-19-21 mm

720LS

Slagdoppen,
Lange en dunne uitvoering



Ø mm	Ø mm	L mm	Ø1 mm	€		
10	15,5	78	24	21,90	2	007200360
11	16,7	78	24	21,90	2	007200361
12	18,0	78	24	21,90	2	007200362
13	19,2	78	24	21,90	2	007200363
14	20,5	78	24	21,90	2	007200364
15	21,7	78	24	23,50	2	007200365
16	23,0	78	24	23,50	2	007200366
17	24,2	78	29	24,70	2	007200367
18	25,5	78	29	26,50	2	007200368
19	26,7	78	29	26,50	2	007200369
21	29,2	78	29	28,00	2	007200371
22	30,5	78	29	28,00	2	007200372
24	33,0	78	29	29,50	2	007200374
27	36,7	78	29	36,00	2	007200377
30	40,5	78	29	45,00	2	007200380
32	43,0	78	29	45,50	2	007200382
36	48,0	78	29	69,50	2	007200386

720LC

Slagdoppen voor wielmoeren,
met gekleurde polymeer beschermhulzen



Ø mm	Ø mm	€		
17	26,5	14,50	2	007200637
19	28,5	14,50	2	007200639
21	30,3	15,40	2	007200641
22	32,4	16,00	2	007200642
24	34,6	17,50	2	007200644



720LC/C3	€		
17-19-21 mm	44,50	1	007200653

148x132x44 mm - 860 g



720LC/S5	€		
17-19-21-22-24 mm	78,00	1	007200645

12"



720LC/PM5	€		
17-19-21-22-24 mm	128,00	1	007200646

PM 1/2-Q5

Magnetische dopsleutel houder

12"



PM 1/2-Q5	€		
	50,00	1	088880233

720IC

Reserve gekleurde polymeer beschermhulzen
voor slagdoppen 720LC-720LCL



720IC	Ø mm	€		
17	17	5,75	1	007200687
19	19	5,75	1	007200689
21	21	5,75	1	007200691
22	22	5,75	1	007200692
24	24	5,75	1	007200694

Beta
Quality Tools

720LCL

Slagdoppen voor wielmoeren
met gekleurde polymeer beschermhulzen,
lange uitvoering

12"



Ø mm	Ø mm	€		
17	26,5	24,00	1	007200737
19	28,5	24,00	1	007200739
21	30,3	24,00	1	007200741

12"



720LCL/C3	€		
17-19-21 mm	90,50	1	007200753

210x50x150 mm - 1,65 kg

720MRC

Slagdopsleutel
met een polymeer beschermhuls en speciale
aansluiting voor Mercedes wielbouten

12"



Ø mm	Ø mm	L mm	€		
17	27	85	23,10	1	007200631

720FRD

Slagdrop voor Ford wielmoeren
met beschadigde aluminium afgedoppen

Vereist wanneer de moeren worden beschadigd door
slagsleutels

12"



Ø mm	L mm	€		
18,5÷19,5	63	21,40	1	007200633

720RNG

slagdrop voor Jeep Renegade wielmoeren
met aluminium beschadigde doppen

Vereist wanneer moerdoppen
worden beschadigd door impactsleutels

12"



Ø mm	L mm	€		
16,5÷17,5	63	20,00	1	007200634

720TC

Momentbegrenzer, gekleurd,
voor wielmoeren,
met 1/2" aandrijfviertkant en viertkant uiteinde
voor dopsleutels

12"



Nm	L mm	€		
90	200	24,20	1	007200769
100	200	24,20	1	007200770
110	200	24,20	1	007200771
120	200	24,20	1	007200772
135	200	24,20	1	007200773

12"



720TC/S5 € 121,00 1 007200779
90-100-110-120-135 Nm
≡ 260x50x175 mm - 1,35 kg

720FTX

Slagdoppen voor Torx® schroeven



12"



	Ø mm	L mm	Ø1 mm	€		
E10	14,0	38	25	19,50	2	007200410
E12	15,9	38	25	19,50	2	007200412
E14	17,7	38	25	19,50	2	007200414
E16	20,0	38	25	19,50	2	007200416
E18	22,0	38	25	19,50	2	007200418
E20	25,0	40	25	21,20	2	007200420
E24	30,0	40	30	21,20	2	007200424



12"



720FTX/SB6 € 131,50 1 007200450
E10-E12-E14
E16-E18-E20

720TX

Slagdoppen voor Torx® schroeven



12"



	Ø mm	L mm	L1 mm	€		
T30	25	78	54	17,60	3	007200460
T40	25	78	54	17,60	3	007200470
T45	25	78	54	17,90	3	007200472
T50	25	78	54	17,90	3	007200474
T55	25	78	54	19,30	3	007200476
T60	25	78	54	20,50	3	007200478

720TX/C6

6-delig set slagdoppen voor Torx® schroeven in metalen kist



12"



720TX/C6 € 147,50 1 007200483
T30-T40-T45
T50-T55-T60

≡ 275x120x65 mm - 5700 g

720ME

Slagdoppen voor inbusschroeven



12"



mm	Ø mm	L mm	L1 mm	€		
5	25	78	54	16,20	3	007200505
6	25	78	54	16,20	3	007200506
8	25	78	54	16,20	3	007200508
10	25	78	54	16,20	3	007200510
12	25	78	54	16,20	3	007200512
14	25	78	54	18,60	3	007200514
17	25	78	54	18,60	3	007200517
19	25	78	54	18,60	3	007200519

720ME/C8

8-delig set slagdoppen voor inbusschroeven



12"



720ME/C8 € 175,00 1 007200525
5-6-8-10-12
14-17-19 mm

≡ 270x120x45 mm - 1710 g

9899 720ME/C8 € 15,00 1 098990130
Thermogevormde inlay, leeg

720XZN

Slagdoppen met XZN® profiel



12"



	Ø mm	L mm	L1 mm	€		
M4	25	77	53	18,30	3	007201504
M5	25	77	53	18,30	3	007201505
M6	25	77	53	18,30	3	007201506
M8	25	77	53	18,30	3	007201508
M10	25	77	53	18,70	3	007201510
M12	25	77	53	19,10	3	007201512
M14	25	77	53	19,10	3	007201514
M16	25	77	53	19,50	3	007201516
M18	25	77	53	20,50	3	007201518

720XZN/C6

6 slagdoppen voor XZN®



12"



720XZN/C6 € 152,00 1 007201530
M8-M10-M12-M14
M16-M18

≡ 275x120x65 mm - 5700 g

720/SN

slagdoppen, gelede serie



12"



mm	Ø mm	L mm	Ø1 mm	€		
17	25,7	69,6	30	65,00	2	007200087
19	28,2	73,6	30	65,00	2	007200089
24	34,5	75,6	30	70,00	2	007200094

720/15

Verlooptop 1/2" naar 3/8"



12"



L mm	Ø mm	□	■	€		
37,5	25	1/2	3/8	13,10	3	007200810



Altijd het toegestane koppel volgen en gelijkmatig en progressief aantrekken om het breken en eventuele verwondingen te voorkomen.

720/16

Verlooptop 1/2" naar 3/4"



12"



L mm	Ø mm	□	■	€		
44	30	1/2	3/4	22,20	3	007200814

720/20

1/2" verlengstukken

12"



L	Ø	€	3	007200818
mm	mm			
75	25	23,00		

720/21

1/2" verlengstukken

12"



L	Ø	€	3	007200822
mm	mm			
125	25	24,90		

720/22

slagverlengstuk, 1/2" aansluiting

12"



L	Ø	€	3	007200824
mm	mm			
250	25	30,00		

720/25

1/2" cardangewricht

12"



L	Ø	€	2	007200831
mm	mm			
64	28	43,50		

720/OR... - 720/SP...

Rubber O ringen en borgstiften

12"

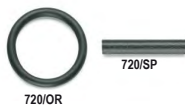

	720	720TX	€	10	007200923
720/OR1	10+14	T30+T60	1,50		
720/OR2	15+36		1,50		10 007200924
720/SP1	10+14	T30+T60	2,19		10 007200913
720/SP2	15+36		2,19		10 007200914

727PI/16 1/2

slagdrop bithouder voor item 727/ES16, 727/ES16TX en 727/ES16XZN

12"



Ø	L	Ø	1/2"	€	2	007270015
mm	mm	mm				
28	42	16		40,00		

727PI/16

Slagbithouder voor item 727/ES16 en 727/ES16TX

3/4"



Ø	L	Ø	3/4"	€	2	007270016
mm	mm	mm				
44	52	16		50,00		

727/ES16

Slag bits, 16 mm aansluiting

Ø



mm	Ø	L	€	2	007270110
mm	mm	mm			
10	16	40	17,50		2 007270110
12	16	40	17,50		2 007270112
13	16	40	17,50		2 007270113
14	16	40	17,50		2 007270114
16	16	40	19,00		2 007270116
17	16	40	19,00		2 007270117
18	16	40	20,10		2 007270118
19	16	40	20,10		2 007270119
22	16	40	22,30		2 007270122

727/ES16TX

Slag bits voor Torx® schroeven, 16 mm aansluiting

Ø



Ø	mm	L	€	2	007270355
T55	16	50	26,00		2 007270355
T60	16	50	26,00		2 007270360
T70	16	50	26,00		2 007270370

727/ES16XZN

Krachtbits voor XZN schroeven 16mm aansluiting

Ø



Ø	mm	L	€	2	007270606
M6	16	60	36,50		2 007270606
M8	16	60	36,50		2 007270608
M10	16	60	36,50		2 007270610
M12	16	60	36,50		2 007270612
M14	16	60	36,50		2 007270614
M16	16	60	36,50		2 007270616
M18	16	60	39,50		2 007270618

Beta

Beta

727PI/22

Slagbithouder voor item 727/ES22 en 727/ES22TX



Ø mm	L mm	Ø mm	€	Hand	Computer
54	70	22	79,00	2	007270022

727/ES22

Slag bits, 22 mm aansluiting



mm	Ø mm	L mm	€	Hand	Computer
19	22	50	22,70	2	007270219
22	22	50	22,70	2	007270222
24	22	50	24,90	2	007270224
27	22	50	28,00	2	007270227
30	22	50	33,50	2	007270230
32	22	50	36,00	2	007270232

727/ES22TX

Slag bits voor Torx® schroeven, 22 mm aansluiting



Ø	Ø mm	L mm	€	Hand	Computer
T80	22	60	36,00	2	007270480
T90	22	60	36,50	2	007270490
T100	22	60	36,50	2	007270500

727/C16

12 slag bits en 4 accessories



727/C16	€	Hand	Computer
	499,00	1	007270900

- 727PI/16
- 727/ES16 14-17-19 mm
- 727/ES16TX T55-T60-T70
- 727PI/22
- 727/ES22 22-24-27 mm
- 727/ES22TX T80-T90-T100
- 96BPC 3-4 mm

335x145x60 mm - 3,6 kg

727PI/32

slagbithouder voor item 727/ES32

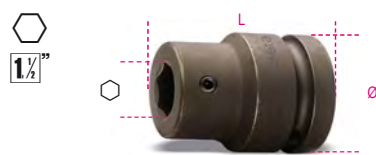

Ø mm	L mm	Ø mm	€	Hand	Computer
86	66	32	196,00	1	007270032

727/ES32

Zeskant slag bit, 32 mm

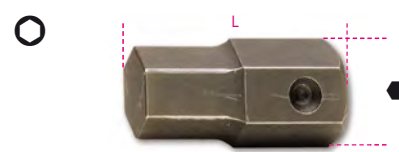

mm	Ø mm	L mm	€	Hand	Computer
19	32	44	50,00	2	007270519
22	32	44	50,00	2	007270522
24	32	44	50,00	2	007270524
27	32	44	50,00	2	007270527
30	32	44	50,00	2	007270530
32	32	44	50,00	2	007270532
36	32	44	57,00	2	007270536

728

Slagdoppen, standaard modellen



UNI/ISO 2725 DIN 3129

Ø mm	Ø mm	L mm	Ø1 mm	€	Hand	Computer
17	30,0	51	44	29,50	2	007280017
18	31,0	51	44	29,50	2	007280018
19	32,5	51	44	29,50	2	007280019
21	35,0	51	44	29,50	2	007280021
22	36,0	51	44	29,50	2	007280022
23	37,5	51	44	30,00	2	007280023
24	38,5	51	44	30,00	2	007280024
27	42,5	53	44	30,00	2	007280027
28	44,0	53	44	32,00	2	007280028
30	46,0	53	44	32,50	2	007280030
32	48,5	57	44	33,50	2	007280032
33	50,0	57	44	36,00	2	007280033
34	51,0	57	44	36,50	2	007280034
35	52,5	57	44	37,50	2	007280035
36	53,5	57	44	38,50	2	007280036
38	56,0	57	44	44,00	1	007280038
40	58,5	58	44	46,00	1	007280040
41	60,0	58	44	46,50	1	007280041
44	64,0	62	44	50,00	1	007280044
45	65,0	62	44	51,50	1	007280045
46	66,0	62	44	54,00	1	007280046
50	71,0	68	54	61,00	1	007280050
55	77,5	71	54	67,00	1	007280055
60	83,0	73	54	79,00	1	007280060
65	88,0	78	54	85,50	1	007280065

728/C10

10-delig set 3/4" slagdoppen



728/C10	€	Hand	Computer
17-19-22-24-27-30-32-36-41-46 mm	384,00	1	007280910

275x120x65 mm - 5,7 kg

728B

Slagdoppen twaalfkant



UNI/ISO 2725 DIN 3129

Ø mm	Ø mm	L mm	Ø1 mm	€	Hand	Computer
17	28,5	50	38	29,00	2	007280117
19	30	52	38	29,00	2	007280119
21	32	52	38	29,00	2	007280121
22	34	52	38	29,00	2	007280122
23	35	52	38	30,00	2	007280123
24	36	52	38	30,00	2	007280124
27	40	52	40	30,00	2	007280127
29	42	52	42	31,50	2	007280129
30	44	52	44	32,00	2	007280130
32	48	52	44	33,50	2	007280132
33	50	56	44	36,00	2	007280133
34	51	56	44	36,00	2	007280134
35	52	56	44	37,00	2	007280135
36	53,5	56	44	38,00	2	007280136
38	56	56	44	42,50	1	007280138
41	60	58	44	45,50	1	007280141
46	67	63	44	54,00	1	007280146

728B/C10

10-delig set slagdoppen twaalfkant



728B/C10	€	Hand	Computer
17-19-22-24-27-30-32-36-41-46 mm	381,00	1	007280930

275x120x65 mm - 5,7 kg



728AS

Slagdoppen, standaard uitvoering



"	Ø mm	L mm	Ø1 mm	€		
3/4	32,0	51	41	28,00	1	007280219
13/16	35,0	51	41	28,00	1	007280221
7/8	36,0	51	41	28,50	1	007280222
15/16	38,5	51	41	28,50	1	007280224
1	40,0	53	41	29,50	1	007280225
1.1/16	42,5	53	44	31,00	1	007280227
1.1/8	44,0	53	44	32,00	1	007280230
1.1/4	48,5	57	44	32,50	1	007280232
1.5/16	50,0	57	44	35,00	1	007280233
1.7/16	53,5	57	44	38,00	1	007280236
1.1/2	56,0	57	44	40,50	1	007280238
1.5/8	60,0	58	44	44,00	1	007280241

728FTX

Slagdoppen, voor Torx® bouten



"	Ø mm	L mm	Ø1 mm	€		
E20	28,5	50	44	39,50	2	007280420
E22	30,0	50	44	39,50	2	007280422
E24	32,5	50	44	39,50	2	007280424

728ME

Slagdoppen met inbus



mm	Ø mm	L mm	L1 mm	€		
12	44	100	67	35,00	3	007280712
14	44	100	67	39,00	3	007280714
17	44	100	67	39,00	3	007280717
19	44	100	67	39,00	3	007280719
22	44	100	67	45,00	3	007280722
24	44	100	67	45,00	3	007280724

728ME/C6

6 slagdoppen voor inbuschroeven



728ME/C6	286,00	1	007280906
12-14-17-19-22-24 mm			

335x145x60 mm - 4,0 kg

728L

Slagdrop, lange uitvoering



"	Ø mm	L mm	Ø1 mm	€		
17	30	90	44	46,50	2	007280317
19	32,5	90	44	46,50	2	007280319
21	35,0	90	44	46,50	2	007280321
22	36,0	90	44	46,50	2	007280322
24	38,5	90	44	46,50	2	007280324
26	41,0	90	44	46,50	2	007280326
27	42,5	90	44	46,50	2	007280327
30	46,0	90	44	49,00	2	007280330
32	48,5	90	44	53,00	2	007280332
33	50,0	90	44	56,00	1	007280333
34	51,0	90	44	57,00	1	007280334
36	53,5	90	44	60,00	1	007280336
38	56,0	90	44	68,00	1	007280338
41	60,0	90	44	72,00	1	007280341
44	64,0	90	44	80,50	1	007280344
46	66,0	90	44	80,50	1	007280346
50	71,0	90	44	100,00	1	007280350
55	77,5	100	54	129,50	1	007280355



728L/S3	162,00	1	007280393
Ø 30-32-36 mm			

728LS

Slagdoppen, lange dunne modellen



"	Ø mm	L mm	Ø1 mm	€		
17	28,0	100	43	54,50	2	007280517
19	30,5	100	43	54,50	2	007280519
22	34,3	100	43	55,00	2	007280522
24	36,8	100	43	55,00	2	007280524
27	40,5	100	43	55,00	2	007280527
30	44,3	100	43	55,00	2	007280530
32	46,8	100	43	58,50	2	007280532
33	48,0	100	43	60,50	2	007280533
36	51,8	100	43	71,00	1	007280536

728LQ

Slagdoppen, lange uitvoering

(voor ISUZU wiel moeren)



"	L mm	Ø mm	Ø1 mm	€		
19	90	35	43,5	48,00	1	007280619
21	90	42	43,5	48,00	1	007280621

728/15

Verlooppop 3/4" naar 1/2"



L mm	Ø mm	□	■	€		
58	38	3/4	1/2	37,00	2	007280810



Altijd het toegestane koppel volgen en gelijkmatig en progressief aantrekken om het breken en eventuele verwondingen te voorkomen.

728/16

Verlooppop 3/4" naar 1"



L mm	Ø mm	□	■	€		
62	44	3/4	1	45,50	2	007280813

728/21

3/4" verlengstukken



L mm	Ø mm	€		
175	44	55,50	2	007280815

728/22

3/4" verlengstukken



L mm	Ø mm	€		
250	44	64,50	2	007280825

728/22L

3/4" verlengstuk



L mm	Ø mm	€		
330	44	82,00	1	007280826

728/25

3/4" cardangewricht



L mm	Ø mm	€	1	007280830
107,5	44	106,50	1	007280830

728/OR - 728/SP

Rubber O ringen en borgstiften



728 mm	728FTX mm	€	1	007280925
728/OR-15	728/15	2,30	5	007280925
728/OR	17+46 E20+E24	2,35	10	007280926
728/SP	17+46 E20+E24	3,25	10	007280916

729

Slagdoppen, standaard modellen



UNI/ISO 2725 DIN 3129

Ø mm	Ø mm	L mm	Ø1 mm	€	1	007290024
24	41,5	58	54	47,50	1	007290024
27	45,0	60	54	47,50	1	007290027
30	49,0	62	54	47,50	1	007290030
32	51,5	63	54	51,00	1	007290032
33	52,5	63	54	51,00	1	007290033
34	54,0	63	54	51,00	1	007290034
36	56,5	66	54	51,00	1	007290036
38	59,0	66	54	59,50	1	007290038
41	62,5	68	54	59,50	1	007290041
46	69,0	72	54	65,50	1	007290046
50	74,0	76	54	79,00	1	007290050
55	80,0	84	54	86,00	1	007290055
60	86,5	88	54	103,50	1	007290060
65	92,5	92	54	119,00	1	007290065
70	99,0	96	54	161,00	1	007290070
75	105,0	102	63	189,00	1	007290075
80	111,5	102	63	206,50	1	007290080

729L

Slagdoppen, lange modellen



Ø mm	Ø mm	L mm	Ø1 mm	€	1	007290324
24	41,5	108	54	86,50	1	007290324
27	45,0	108	54	86,50	1	007290327
30	49,0	108	54	86,50	1	007290330
32	51,5	108	54	86,50	1	007290332
33	52,2	108	54	87,00	1	007290333
34	54,0	108	54	87,00	1	007290334
36	56,5	108	54	87,00	1	007290336
41	62,5	108	54	98,50	1	007290341
46	69,0	108	54	113,00	1	007290346
50	74,0	108	54	126,00	1	007290350

Ø mm	Ø mm	L mm	Ø1 mm	€	1	007290355
55	80,0	108	54	151,50	1	007290355
60	86,5	108	54	163,50	1	007290360
65	92,5	108	54	197,00	1	007290365
70	99,0	108	54	224,00	1	007290370
75	105,0	108	63	254,00	1	007290375
80	111,5	108	63	271,00	1	007290380

729LS

Slagdoppen, lange dunne modellen



Ø mm	Ø mm	L mm	Ø1 mm	€	1	007290522
22	36,0	108	53	86,50	1	007290522
24	38,5	108	53	86,50	1	007290524
27	46,0	108	53	86,50	1	007290527
30	50,0	108	53	90,00	1	007290530
32	50,0	108	53	90,00	1	007290532
33	52,0	108	53	90,00	1	007290533
36	56,0	108	53	90,00	1	007290536

729T

Slagdop begrenzer voor wielmoeren



Ø mm	Nm	L mm	€	1	007290724
24	350	300	157,50	1	007290724
27	450	300	159,00	1	007290727
30	500	300	160,50	1	007290730
32	450	300	161,50	1	007290732
32	600	300	165,00	1	007290762
33	600	300	170,00	1	007290763
36	600	300	180,50	1	007290736

729/15

Verlooppop 1" naar 3/4"



L mm	Ø mm	1	3/4	€	1	007290810
66,5	54	1	3/4	58,50	1	007290810



Altijd het toegestane koppel volgen en gelijkmatig en progressief aantrekken om het breken en eventuele verwondingen te voorkomen.

729/16

Verlooppop 1" naar 1.1/2"



L mm	Ø mm	1	1.1/2	€	1	007290813
88	54,0	1	1.1/2	98,50	1	007290813

729/21

1" verlengstukken



L mm	Ø mm	€	1	007290815
175	54	89,00	1	007290815

729/21L

slagverlengstuk, 1" aansluiting



L mm	Ø mm	€	1	007290826
250	54	107,00	1	007290826

729/22

1" verlengstukken



L mm	Ø mm	€	1	007290825
330	54	128,50	1	007290825

729/25

1" cardangewricht



L mm	Ø mm	€	1	007290830
130	54	183,50	1	007290830

729/OR... - 729/SP...

Rubber O ringen en borgstiften



729/OR1	728 mm	729-730 mm	€	1	007290927
729/OR1	50+60	24+70	2,46	5	007290927
729/OR2	75+125		4,35	5	007290928
729/SP1	50+60	24+70	2,46	5	007290917
729/SP2	75+125		4,15	5	007290918

730

Slagdoppen, standaard modellen



UNI/ISO 2725 DIN 3129

Ø mm	Ø mm	L mm	Ø1 mm	€	1	007300050
50	81	87	84	247,00	1	007300050
55	88	90	86	252,00	1	007300055
60	94	95	86	283,00	1	007300060
65	100	100	86	315,00	1	007300065
70	106	105	86	365,00	1	007300070
75	113	110	86	427,00	1	007300075
80	119	115	86	489,00	1	007300080
85	125	120	86	542,00	1	007300085
90	132	125	86	614,00	1	007300090
95	138	125	96	696,00	1	007300095
100	144	130	96	847,00	1	007300100
105	150	135	96	928,00	1	007300105
110	157	140	96	1.006,00	1	007300110
115	163	140	96	1.098,00	1	007300115
120	169	145	96	1.205,00	1	007300120
125	175	145	96	1.260,00	1	007300125

730L

slagdoppen lange uitvoering



Ø mm	Ø mm	L mm	Ø1 mm	€	1	007300350
50	81	135	86	398,00	1	007300350
55	87	140	86	409,00	1	007300355
60	93	150	86	452,00	1	007300360
65	97	150	86	496,00	1	007300365
70	105	160	86	586,00	1	007300370
75	110	170	86	679,00	1	007300375
80	116	170	86	776,00	1	007300380
85	125	170	86	859,00	1	007300385
90	130	170	86	977,00	1	007300390
95	137	180	95	1.139,00	1	007300395
100	144	190	95	1.320,00	1	007300400
105	150	190	95	1.470,00	1	007300405
110	156	200	95	1.605,00	1	007300410
115	160	200	95	1.725,00	1	007300415
120	168	210	95	1.930,00	1	007300420

730/15

Verloepdop



L mm	Ø mm	□	■	€	1	007300810
105	84,0	1.1/2	1	208,50	1	007300810



Altijd het toegestane koppel volgen en gelijkmatig en progressief aantrekken om het breken en eventuele verwondingen te voorkomen.

730/21

slagverlengstuk, 1.1/2" aansluiting



L mm	Ø mm	€	1	007300822
250	86	713,00	1	007300822

730/25

slagdop 1.1/2" cardangewricht



L mm	Ø mm	€	1	007300830
150	86	748,00	1	007300830

733/15

Verloepdop



L mm	Ø mm	□	■	€	1	007330810
156	127	2.1/2	1.1/2	703,00	1	007330810

BITS

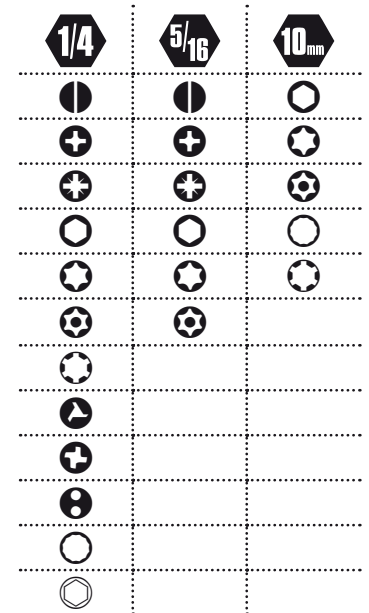

ISO 1173-C 6,3



aansluiting voor borgveer

ISO 1173-E 6,3



aansluiting voor kogelgroef

851

Magnetische bithouder met handgreep



L1 mm	L mm	€	2	008510165
45	165	18,70	2	008510165
125	245	21,40	2	008510245

851SR

Bithouder met handgreep



L mm	L1 mm	€	2	008510001
230	110	26,00	2	008510001

852

T-sleutel met cardangewricht en bithouder

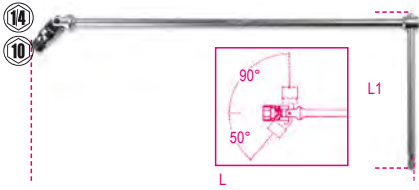

	L mm	L1 mm	€		
1/4"	400	160	54,50	2	008520006
10 mm	400	160	54,50	2	008520010

855P

Bit houder met ratelmechanisme, gevormde handgreep en houder voor 7 bits

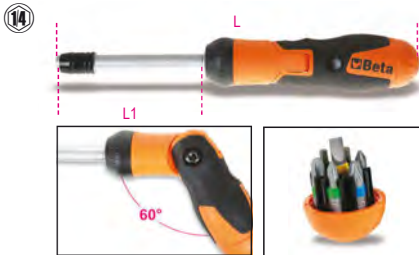

L mm	L1 mm	€		
240	100	85,00	1	008550010

	+	860PH	PH1 - PH2
	+	860PZ	PZ1 - PZ2
	+	860LP	LP 0,8x5,5 mm
	+	860PE	4 - 5 mm

860LP

Bits voor sleufschroeven, gekleurd



ISO 2351-1
ISO 1173 C 6,3

SxA mm	L mm	€		
0,5x3	25	2,23	5	008600005
0,6x4,5	25	2,23	5	008600010
0,8x5,5	25	2,23	5	008600015
1x5,5	25	2,23	5	008600020
1,2x6,5	25	2,23	5	008600025

860PH

Bits voor kruiskopschroeven met Phillips® profiel, gekleurd



ISO 2351-2
ISO 1173 C 6,3

PH	L mm	€		
0	25	2,23	5	008600220
1	25	2,23	5	008600225
2	25	2,23	5	008600230
3	25	2,23	5	008600245
4	25	3,30	5	008600250

860PZ

Bits voor kruiskopschroeven met Pozidriv® - Supadriv® profiel, gekleurd



ISO 2351-2
ISO 1173 C 6,3

PZ	L mm	€		
1	25	2,23	5	008600320
2	25	2,23	5	008600325
3	25	2,23	5	008600330
4	25	3,30	5	008600335

860PE

Bits voor binnenzekant schroeven, gekleurd



ISO 2351-3
ISO 1173 C 6,3

mm	L mm	€		
2	25	2,35	5	008600101
2,5	25	2,35	5	008600102
3	25	2,35	5	008600103
4	25	2,35	5	008600104
5	25	2,35	5	008600105
6	25	2,35	5	008600106
8	25	3,05	5	008600108
10	25	3,05	5	008600110

860TX

Bits voor schroeven met Torx® profiel, gekleurd



ISO 1173 C 6,3

	L mm	€		
T6	25	3,05	5	008600704
T7	25	3,05	5	008600705
T8	25	3,05	5	008600710
T9	25	3,05	5	008600715
T10	25	2,40	5	008600720
T15	25	2,40	5	008600725
T20	25	2,40	5	008600730
T25	25	2,40	5	008600735
T27	25	2,40	5	008600740
T30	25	2,40	5	008600745
T40	25	2,40	5	008600750

860RTX

Bits voor schroeven met Tamper Resistant Torx® profiel, gekleurd



ISO 1173 C 6,3

	L mm	€		
T9	25	3,30	5	008600550
T10	25	3,30	5	008600555
T15	25	3,30	5	008600560
T20	25	3,30	5	008600565
T25	25	3,30	5	008600570
T27	25	3,30	5	008600575
T30	25	3,30	5	008600580
T40	25	3,30	5	008600585

860/55

Omschakelbare ratel voor bits



L mm	Ø	€		
100	1/4	38,00	3	008600870

860/58

Ratel met bithouder en draaibare handgreep

- Bit past op beide zijde van de ratel, voor vast en los draaien
- Handgreep uit twee componenten



	L mm	Ø	A mm	€		
860/58	126	1/4"	27	15	85,00	1 008600884

860/C27

25 bits, 1 verbindingsstuk en 1 omschakelbare ratel in kunststof koffer



	€		
860/C27	103,50	1	008600880

	860/55	100 mm
	860LP	0,5x3-1,0x5,5-1,2x6,5 mm
	860PH	PH1-PH2(x2)-PH3
	860PZ	PZ1-PZ2(x2)-PZ3
	860PE	2-2,5-3-4-5-6 mm
	860TX	T6-T8-T10-T15-T20-T25-T30-T40
	892/0	● 1/4 ■ 1/4

860PHZ/A10

10-del.set bits met magnetische bithouder in kunststof houder



	€		
860PHZ/A10	42,50	1	008600910

	860PH	PH1	n.
		PH2	1
		PH3	3
	860PZ	PZ1	1
		PZ2	1
		PZ3	3
	882M1	○ 1/4 ■ 1/4	1

860PE/A10

10-del.set bits met magnetische bithouder in kunststof houder



860PE/A10 € 44,50 1 008600920

	860PE	2 - 2,5 mm	n.
	882M1	3 - 4 - 5 - 6 mm	1
		○ 1/4 ● 1/4	2

860TX/A10

10 delig set bits met magnetische bithouder in kunststof houder



860TX/A10 € 46,50 1 008600970

	860TX	T7 - T8 - T9 - T10 - T15 - T20	n.
	882M1	T25 - T27 - T30 - T40	1
		○ 1/4 ● 1/4	1

860MIX/A10

10 delig set bits met magnetische bithouder in kunststof houder



860MIX/A10 € 42,50 1 008600900

	860LP	0,5x3 - 1x5,5 - 1,2x6,5 mm	n.
	860PH	PH1	1
		PH2	2
		PH3	1
	860PZ	PZ1 - PZ2 - PZ3	1
	882M1	○ 1/4 ● 1/4	1

860MIX/A31

30-delig set bits met magnetische snelwissel houder in kunststof box



860MIX/A31 € 103,50 1 008600902

	860LP	0,5x3 - 0,6x4,5 - 0,8x5,5
	860PE	1,0x5,5 - 1,2x6,5 mm
	860PH	2 - 2,5 - 3 - 4 - 5 - 6
	860PZ	8 - 10 mm
	860RTX	PH0 - PH1 - PH2 - PH3 - PH4
	882MSR 50	PZ1 - PZ2 - PZ3 - PZ4
		T9 - T10 - T15 - T20
		T25 - T27 - T30 - T40
		○ 1/4 ● 1/4

860/C38P

1 omschakelbare ratel met bits aansluiting en gevormde handgreep, 27 bits, 8 zeskant dopsleutels en 2 toebehoren



860/C38P € 223,50 1 008600878

	860LP	0,6x4,5-0,8x5,5-1,0x5,5-1,2x6,5 mm
	860PE	2-2,5-3-4(x2)-5(x2) mm
	860PH	PH1(x2)-PH2(x2)-PH3
	860PZ	PZ1(x2)-PZ2(x2)-PZ3
	860TX	T10-T15-T20-T25-T30-T40
	900	5-5,5-6-7-8-9-10-13 mm
	892/0	● 1/4 ■ 1/4
	892/3	● 1/4 ■ 1/4
	855P	240 mm

270x120x45 mm

861LP

Bits voor sleufschroeven



ISO 2351-1

ISO 1173 C 6,3

SxA mm	L mm	€	1/4	1/4
0,5x3	25	1,41	10	008610005
0,6x4	25	1,41	10	008610007
0,6x4,5	25	1,41	10	008610010
0,8x5,5	25	1,41	10	008610015
1x5,5	25	1,41	10	008610020
1,2x6,5	25	1,41	10	008610025
1,2x8	25	2,73	10	008610028
1,6x8	25	2,73	10	008610030

861PH

Bits voor Phillips® kruiskopschroeven



ISO 2351-2

ISO 1173 C 6,3

PH	L mm	€	1/4	1/4
0	25	1,42	10	008610200
1	25	1,42	10	008610205
2	25	1,44	10	008610210
2L	50	2,73	10	008610213
3	25	1,42	10	008610215
4	25	3,90	10	008610220

861PH/C

Bits voor Phillips® kruiskopschroeven



ISO 2351-2

ISO 1173 C 6,3

PH	L mm	€	1/4	1/4
0	25	1,10	200	008610250
1	25	1,10	200	008610255
2	25	1,10	200	008610260
2L	50	2,08	100	008610263
3	25	1,10	200	008610265
4	25	2,83	100	008610270

861PZ

Bits voor Pozidriv®- Supadriv® kruiskopschroeven



ISO 2351-2

ISO 1173 C 6,3

PZ	L mm	€	1/4	1/4
1	25	1,36	10	008610300
2	25	1,36	10	008610305
2L	50	2,77	10	008610308
3	25	1,36	10	008610310
4	25	3,90	10	008610315



861PZ/C

Bits voor Pozidriv®- Supadriv® kruiskopschroeven



ISO 2351-2
ISO 1173 C 6,3

PZ	L mm	€		
1	25	1,10	200	008610350
2	25	1,10	200	008610355
2L	50	2,08	100	008610358
3	25	1,10	200	008610360
4	25	2,77	100	008610365

861PE

Bits voor inbusschroeven



ISO 2351-3
ISO 1173 C 6,3

mm	L mm	€		
2	25	1,49	10	008610100
2,5	25	1,49	10	008610105
3	25	1,49	10	008610110
4	25	1,49	10	008610115
5	25	1,49	10	008610120
6	25	1,49	10	008610125
8	25	2,28	10	008610130
10	25	3,05	10	008610135

861TX

Bits voor Torx® schroeven



ISO 1173 C 6,3

Ø	L mm	€		
T5	25	2,01	10	008610399
T6	25	2,01	10	008610400
T7	25	2,01	10	008610405
T8	25	2,01	10	008610410
T9	25	2,01	10	008610415
T10	25	1,68	10	008610420
T15	25	1,68	10	008610425
T20	25	1,68	10	008610430
T25	25	1,68	10	008610435
T27	25	1,68	10	008610440
T30	25	1,68	10	008610445
T40	25	1,68	10	008610450

861TX/C

Bits voor Torx® schroeven

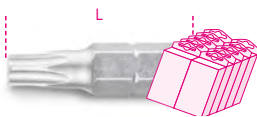

ISO 1173 C 6,3

Ø	L mm	€		
T10	25	1,29	200	008610470
T15	25	1,29	200	008610475
T20	25	1,29	200	008610480
T25	25	1,29	200	008610485
T27	25	1,29	200	008610490
T30	25	1,29	200	008610495
T40	25	1,29	200	008610499

861RTX

Bits voor Tamper Resistant Torx® schroeven



ISO 1173 C 6,3

Ø	L mm	€		
T6	25	3,05	10	008610537
T7	25	3,05	10	008610538
T8	25	3,05	10	008610540
T9	25	3,05	10	008610500
T10	25	3,05	10	008610505
T15	25	3,05	10	008610510
T20	25	3,05	10	008610515
T25	25	3,05	10	008610520
T27	25	3,05	10	008610525
T30	25	3,05	10	008610530
T40	25	3,05	10	008610535
T45	25	5,95	10	008610539

861RIBE

Bits voor RIBE® schroeven



ISO 1173 C 6,3

Ø	L mm	€		
M5	25	1,28	10	008610705
M6	25	1,28	10	008610706
M7	25	1,68	10	008610707
M8	25	1,68	10	008610708
M9	25	2,34	10	008610709

861TRW

Bits voor Tri-Wing® schroeven



ISO 1173 C 6,3

GR	L mm	€		
1	25	2,62	10	008610601
2	25	2,62	10	008610602
3	25	2,62	10	008610603
4	25	2,62	10	008610604
5	25	2,62	10	008610605
6	25	3,85	10	008610606

861TQS

Bits voor Torq-Set® schroeven



ISO 1173 C 6,3

GR	L mm	€		
0	25	2,62	10	008610620
1	25	2,62	10	008610621
2	25	2,62	10	008610622
3	25	2,62	10	008610623
4	25	2,62	10	008610624
5	25	2,62	10	008610625
6	25	2,62	10	008610626
8	25	2,62	10	008610628
10	25	2,62	10	008610630

861SP

Bits voor Spanner schroeven



ISO 1173 C 6,3

SP	D mm	L mm	€		
4	1,5	25	2,08	10	008610650
6	2,4	25	2,08	10	008610653
8	2,8	25	2,08	10	008610656
10	3,3	25	2,08	10	008610658
12	3,9	25	2,08	10	008610660

1483KV-PT/S7



1483KV PT/S7

185

861XZN

Bits voor XZN® schroeven



ISO 1173 C 6,3

Ø	L mm	€		
M5	25	1,28	10	008610725
M6	25	1,28	10	008610726
M8	25	1,69	10	008610728

861/C61P

61-delig set bits met bithouder

1/4



861/C61P € 195,50 1 008610978

	861LP	0,5x3 - 0,6x4,5 - 0,8x5,5 - 1,0x5,5 1,2x6,5 - 1,2x8 - 1,6x8 mm
	861PE	2 - 2,5 - 3 - 4 - 5 - 6 - 8 - 10 mm
	861PH	PH0 - PH1 - PH2 - PH3
	861PZ	PZ1 - PZ2 - PZ3
	861TX	T6 - T7 - T8 - T9 - T10 - T15 T20 - T25 - T27 - T30 - T40
	861RTX	T9 - T10 - T15 - T20 - T25 T27 - T30 - T40
	861TRW	1 - 2 - 3 - 4 - 5 - 6
	861TQS	0 - 1 - 2 - 3 - 4 - 5 - 6 - 8 - 10
	861SP	4 - 6 - 8 - 10 - 12
	851SR	1/4"

270x120x45 mm - 975 g

862LP

Bits voor sleufschroeven

1/4



ISO 2351-1

ISO 1173 E 6,3

SxA mm	L mm	€	5	10
0,5x3	50	4,30	5	008620005
0,6x4,5	50	4,30	5	008620010
0,8x5,5	50	4,30	5	008620015
1x5,5	50	4,30	5	008620020
1,2x6,5	50	4,30	5	008620025
1,2x8	50	5,50	5	008620030
1,6x8	50	5,50	5	008620035

862PH

Bits voor Phillips® kruiskopschroeven

1/4



ISO 2351-2

ISO 1173 E 6,3

PH	L mm	€	5	10
1	50	4,40	5	008620200
2	50	4,40	5	008620205
3	50	4,40	5	008620210

862PH/L

Bits voor Phillips® kruiskopschroeven

1/4



ISO 2351-2

ISO 1173 E 6,3

PH	L mm	€	5	10
1	70	7,65	5	008620230
2	70	7,65	5	008620232
3	70	7,65	5	008620234

862PH-XL

Bits voor Phillips® kruiskopschroeven

1/4



ISO 2351-2ISO 1173 E 6,3

PH	L mm	€	5	10
1	100	7,75	5	008620250
2	100	7,75	5	008620252
3	100	7,75	5	008620254

862PZ

Bits voor Pozidriv®- Supadriv® kruiskopschroeven

1/4



ISO 2351-2

ISO 1173 E 6,3

PZ	L mm	€	5	10
1	50	4,60	5	008620300
2	50	4,60	5	008620305
3	50	4,60	5	008620310

862PE

Bits voor inbuschroeven

1/4



ISO 2351-3

ISO 1173 E 6,3

mm	L mm	€	5	10
3	50	4,60	5	008620103
4	50	4,60	5	008620104
5	50	4,60	5	008620105
6	50	4,60	5	008620106
8	50	6,00	5	008620108

862TX

Bits voor Torx® schroeven

1/4



ISO 1173 E 6,3

T	L mm	€	5	10
T6	50	5,85	5	008620506
T7	50	5,85	5	008620507
T8	50	5,85	5	008620508
T9	50	5,85	5	008620509
T10	50	5,85	5	008620510
T15	50	5,85	5	008620515
T20	50	5,85	5	008620520
T25	50	5,85	5	008620525
T27	50	5,85	5	008620527
T30	50	5,85	5	008620530
T40	50	5,85	5	008620540

862TX/L

Bits voor Torx® schroeven

1/4



ISO 1173 E 6,3

T	L mm	€	5	10
T6	70	6,25	5	008620556
T7	70	6,25	5	008620557
T8	70	6,25	5	008620558
T9	70	6,25	5	008620559
T10	70	6,25	5	008620560
T15	70	6,25	5	008620565
T20	70	6,25	5	008620570
T25	70	6,25	5	008620575
T27	70	6,25	5	008620577
T30	70	6,25	5	008620580
T40	70	6,25	5	008620590

862TX-XL

Bits voor Torx® schroeven

1/4



ISO 1173 E 6,3

T	L mm	€	5	10
T9	100	6,85	5	008620659
T10	100	6,85	5	008620660
T15	100	6,85	5	008620665
T20	100	6,85	5	008620670
T25	100	6,85	5	008620675
T27	100	6,85	5	008620677
T30	100	6,85	5	008620680
T40	100	6,85	5	008620690



862F

Magnetische dopsleutelbits



ISO 1173 E 6,3

mm	L mm	Ø mm	€		
5,5	65	11	7,90	5	008620405
6	65	11	7,90	5	008620406
7	65	11	7,90	5	008620407
8	65	13	7,90	5	008620408
10	65	15	8,45	5	008620410
12	65	18	9,50	5	008620412
13	65	18	10,10	5	008620413

862F/A7

7 magnetisch dopsleutelbits, in kunststof koffer



862F/A7 € 59,50 1 008620950

862F 5,5-6-7-8-10-12-13 mm

862XP/A16

16 bits in box van zakformaat



862XP/A16 € 65,00 1 008620960

- ⊕ PH2(x2)-PH3
- ⊕ PZ2(x2)-PZ3
- ⊗ T20-T25(x2)
- ⊗ T30(x2)-T40(x2)
- 4-5-6 mm

866LP

Bits voor sleufschroeven



ISO 2351-1
ISO 1173 C 8

SxA mm	L mm	€		
1x5,5	41	4,60	10	008660005
1,2x6,5	41	4,60	10	008660010
1,6x8	41	4,60	10	008660015
1,6x10	41	6,00	10	008660020
2x12	41	7,30	10	008660025

866PH

Bits voor Phillips® kruiskopschroeven



ISO 2351-2
ISO 1173 C 8

PH	L mm	€		
1	32	3,60	10	008660200
2	32	3,60	10	008660205
3	32	3,60	10	008660210
4	38	5,40	10	008660215

866PZ

Bits voor Pozidriv®- Supadriv® kruiskopschroeven



ISO 2351-2
ISO 1173 C 8

PZ	L mm	€		
1	32	3,75	10	008660300
2	32	3,75	10	008660305
3	32	3,75	10	008660310
4	38	5,65	10	008660315

866PE

Bits voor inbusschroeven



ISO 2351-3
ISO 1173 C 8

mm	L mm	€		
3	30	3,20	10	008660100
4	30	3,20	10	008660105
5	30	3,20	10	008660110
6	30	3,20	10	008660115
7	30	3,20	10	008660117
8	30	3,20	10	008660120
10	30	4,45	10	008660125
12	30	6,00	10	008660132
14	30	7,70	10	008660134

866TX

Bits voor Torx® schroeven



ISO 1173 C 8

T	L mm	€		
T20	30	3,85	10	008660400
T25	30	3,85	10	008660405
T27	30	3,85	10	008660410
T30	30	3,85	10	008660415
T40	30	3,85	10	008660420
T45	30	3,85	10	008660425
T50	30	3,85	10	008660430
T55	30	5,70	10	008660435
T60	30	7,45	10	008660440
T70	30	8,35	10	008660445

866RTX

Bits voor Tamper Resistant Torx® schroeven



ISO 1173 C 8

T	L mm	€		
T40	30	4,60	10	008660520
T45	30	4,60	10	008660525
T50	30	4,60	10	008660530
T55	30	6,50	10	008660535
T60	30	8,85	10	008660540
T70	30	10,80	10	008660545

867PE

Bits voor inbusschroeven



mm	L mm	€		
4	30	2,16	5	008670104
5	30	2,16	5	008670105
6	30	2,16	5	008670106
7	30	2,16	5	008670107
8	30	2,16	5	008670108
10	30	2,16	5	008670110
12	30	3,25	5	008670112

867PE/L

Bits voor inbusschroeven



mm	L mm	€		
4	75	3,90	5	008670154
5	75	3,90	5	008670155
6	75	3,90	5	008670156
7	75	3,90	5	008670157
8	75	3,90	5	008670158
10	75	3,90	5	008670160
12	75	5,35	5	008670162



867XZN

Bits voor XZN® schroeven



	L mm	€	5	008670204
M4	30	2,78	5	008670204
M5	30	2,78	5	008670205
M6	30	2,78	5	008670206
M8	30	2,78	5	008670208
M10	30	2,78	5	008670210
M12	30	3,80	5	008670212

867XZN/L

Bits voor XZN® schroeven



	L mm	€	5	008670255
M5	75	4,25	5	008670255
M6	75	4,25	5	008670256
M8	75	4,25	5	008670258
M10	75	4,25	5	008670260
M12	75	5,70	5	008670262

867TX

Bits voor Torx® schroeven



	L mm	€	5	008670400
T20	30	2,16	5	008670400
T25	30	2,16	5	008670405
T30	30	2,16	5	008670410
T40	30	2,16	5	008670415
T45	30	2,16	5	008670420
T50	30	2,16	5	008670425
T55	30	2,16	5	008670430

867TX/L

Bits voor Torx® schroeven



	L mm	€	5	008670450
T20	75	3,50	5	008670450
T25	75	3,50	5	008670455
T30	75	3,50	5	008670460
T40	75	3,50	5	008670465
T45	75	3,50	5	008670470
T50	75	3,50	5	008670475
T55	75	3,50	5	008670480

867RTX

Bits voor Tamper Resistant Torx® schroeven



	L mm	€	5	008670500
T20	30	2,25	5	008670500
T25	30	2,25	5	008670505
T30	30	2,25	5	008670510
T40	30	2,25	5	008670515
T45	30	2,25	5	008670520
T50	30	2,25	5	008670525
T55	30	2,25	5	008670530

867RTX/L

Bits voor Tamper Resistant Torx® schroeven



	L mm	€	5	008670550
T20	75	3,75	5	008670550
T25	75	3,75	5	008670555
T30	75	3,75	5	008670560
T40	75	3,75	5	008670565
T45	75	3,75	5	008670570
T50	75	3,75	5	008670575
T55	75	3,75	5	008670580

867RIBE

Bits voor schroeven met RIBE® aansluiting



	L mm	€	5	008670705
M5	30	2,38	5	008670705
M6	30	2,38	5	008670706
M7	30	2,38	5	008670707
M8	30	2,38	5	008670708
M9	30	2,38	5	008670709
M10	30	2,38	5	008670710
M11	30	3,50	5	008670711
M12	30	3,50	5	008670712
M13	30	3,50	5	008670713

867RIBE/L

Bits voor schroeven met RIBE® aansluiting



	L mm	€	5	008670755
M5	75	3,90	5	008670755
M6	75	3,90	5	008670756
M7	75	3,90	5	008670757
M8	75	3,90	5	008670758
M9	75	3,90	5	008670759
M10	75	3,90	5	008670760
M11	75	5,00	5	008670761
M12	75	5,00	5	008670762
M13	75	5,00	5	008670763

867/...

Bithouderdop voor bits 867



	mm	mm	mm	mm	€	5	008670600
867/1	10	3/8"	38	17	7,85	5	008670600
867/2	10	1/2"	38	22	8,80	5	008670601

867/C20

18 bits met RIBE® profiel, met 10 mm zeskant aansluiting en 2 toebehoren



	€	1	008670920
867/C20	143,50	1	008670920

	867RIBE	5-6-7-8-9-10-11-12-13 mm
	867RIBE/L	5-6-7-8-9-10-11-12-13 mm
	867/1	
	867/2	
335x145x60 mm - 1,7 kg		

867/C38

38 zeskant bits, 10 mm, 1 bithouder met T handgreep en cardangewricht



	€	1	008670938
867/C38	267,00	1	008670938

	852	10 mm
	867PE	4-5-6-7-8-10-12mm
	867PE/L	4-5-6-7-8-10-12mm
	867XZN	M5-M6-M8-M10-M12
	867XZN/L	M5-M6-M8-M10-M12
	867TX	T20-T25-T30-T40-T45-T50-T55
	867TX/L	T20-T25-T30-T40-T45-T50-T55
	882	
420x185x60 mm - 3 kg		

867/C52

Assortiment van 52 bits met 10 mm en 2 toebehoren



867/C52 € 155,00 1 008670901

	○ 867PE	4-5-6-7-8-10-12 mm
	○ 867PE/L	4-5-6-7-8-10-12 mm
	○ 867XZN	M5-M6-M8-M10-M12
	○ 867XZN/L	M5-M6-M8-M10-M12
	⊕ 867TX	T20-T25-T30-T40-T45-T50-T55
	⊕ 867TX/L	T20-T25-T30-T40-T45-T50-T55
	⊕ 867RTX	T20-T25-T30-T40-T45-T50-T55
	⊕ 867RTX/L	T20-T25-T30-T40-T45-T50-T55
	867/1	○ 10 mm - □ 3/8"
	867/2	○ 10 mm - □ 1/2"

250x170x70 mm - 2,1 kg

852



852 1/4 79,116

882

Bithouder met borgring voor bits 5,5 mm aansluiting en 1/4" aansluiting



ISO 1173 E 6,3

L mm 57 1/4 1/4 11 € 19,30 5 008820001

882AN

Haakse bithouder, 1/4" zeskant aansluiting

- Voor elektrische boormachines met een 10 mm en 13mm boorhouders en 1/4" moeraanzetters
- Max. toeren: 3600 rpm
- Max. aanhaalkoppel: 30 Nm
- Voorzien van snelwissel bithouder
- Overbrenging ratio: 1:1
- Aansluiting aan het gereedschap door 1/4" zeskant D6.3



ISO 1173 E 6,3
ISO 1173 C 6,3

L mm 137 1/4 1/4 € 90,00 1 008820090

882M1

Bithouder met borgring voor bits 5,5 mm aansluiting en 1/4" aansluiting



ISO 1173 E 6,3

L mm 50 1/4 1/4 11 € 20,40 5 008820006

882M

Bithouder met borgring voor bits 5,5 mm aansluiting en 1/4" aansluiting



ISO 1173 E 6,3

L mm 75 1/4 1/4 11 € 25,50 5 008820005

882MSR

Magnetische snelwissel bithouder



ISO 1173 E 6,3

L mm 50 75 1/4 1/4 11 € 23,60 27,50 5 008820205 5 008820207

882P

Magnetische bithouder, lang



L mm 80 1/4 1/4 10 € 19,60 5 008820080



892

Dophouders



892/0
892/1
892/2
892/3
892/4
892/5
892/6
892/7

	□	●	L mm	€	5	5
	mm	mm	mm			
892/0	1/4	1/4	25	6,20	5	008920000
* 892/1	1/4	5/5	50	12,00	5	008920001
* 892/2	3/8	5,5	50	18,40	5	008920002
* 892/3	1/4	1/4	50	12,00	5	008920003
* 892/4	3/8	1/4	50	18,50	5	008920004
892/5	1/4	5/16	75	17,10	5	008920005
892/6	3/8	5/16	75	24,70	5	008920006
892/7	1/2	1/4	75	26,00	5	008920007

* ISO 1173 A 5,5
° ISO 1173 C 6,3

895

Bithouderdop voor bits 861-862-866



DIN 7427

	○	□	L mm	Ø mm	€	5	5
	mm	mm	mm	mm			
895/1	1/4	1/4	25,4	12	14,30	5	008950000
895/3	1/4	3/8	29	16,8	17,30	5	008950001
895/4	5/16	3/8	29	16,8	17,30	5	008950002
895/5	1/4	1/2	38	22	17,30	5	008950005
895/6	5/16	1/2	38	22	17,30	5	008950003

897

Flexibele schroevendraaier met bithouder



L mm 280 L1 mm 154 € 33,00 2 008970010

897L

Flexibele schroevendraaier met bithouder Lang model



L mm 500 L1 mm 380 € 38,00 2 008970015

Compacte kop



Werkt in kleine ruimtes, onder een hoek van maximaal 5°, dankzij de 72-tands ratelmechanisme



Voorkomt wegslijpen of loslaten onder spanning

- Het drukken van de hand op de ratelkop veroorzaakt geen omschakeling en zorgt altijd voor een vrije terugkeer van de handgreep
- Omschakeling met één hand
- Uitstekende mechanische eigenschappen



Verminderde werkbelasting, 17 tanden altijd in contact met het tandwiel

900

Dopsleutels zeskant



UNI/ISO 2725 DIN 3124

Ø mm	Ø mm	L mm	Ø1 mm	€	U	PC
3,2	6,6	25	11,8	4,50	10	009000032
4	6,8	25	11,8	4,50	10	009000040
4,5	7,4	25	11,8	4,50	10	009000045
5	8,0	25	11,8	4,50	10	009000050
5,5	8,7	25	11,8	4,50	10	009000055
6	9,3	25	11,8	4,50	10	009000060
7	10,4	25	11,8	4,50	10	009000070
8	11,8	25	12,7	4,50	10	009000080
9	12,7	25	11,8	4,50	10	009000090
10	14,2	25	12,0	4,50	10	009000100
11	15,8	25	12,5	4,50	10	009000110
12	17,2	25	13,5	4,50	10	009000120
13	18,0	25	13,5	4,55	10	009000130
14	20,0	25	15,0	4,75	10	009000140



900/SB13	€ 80,50	U	PC
4-4,5-5-5,5-6-7-8-9		1	009000150
10-11-12-13-14 mm			

900MC

Zeskant dopsleutels, gekleurd



Ø mm	L mm	Ø mm	Ø1 mm	€	U	PC
4	24,8	6,7	11,8	4,65	5	009002040
5	24,8	8,0	11,8	4,65	5	009002050
6	24,8	9,2	11,8	4,65	5	009002060
7	24,8	10,7	11,8	4,65	5	009002070
8	24,8	11,8	11,8	4,65	5	009002080
9	24,8	12,8	12,8	4,65	5	009002090
10	24,8	14,8	14,8	4,65	5	009002100
11	24,8	15,8	15,8	4,65	5	009002110
12	24,8	16,8	16,8	4,65	5	009002120
13	24,8	17,8	17,8	4,75	5	009002130
14	24,8	19,5	19,5	4,80	5	009002140



900MB

Dopsleutels twaalfkant



UNI/ISO 2725 DIN 3124

Ø mm	Ø mm	L mm	Ø1 mm	€	U	PC
4	6,7	22	11,2	8,65	5	009000160
5	7,7	25	11,2	8,65	5	009000161
5,5	8,3	25	11,2	8,65	5	009000162
6	9,0	25	11,2	8,65	5	009000163
7	10,2	25	11,2	8,65	5	009000164
8	11,3	25	12,0	8,65	5	009000165
9	13,0	25	12,0	8,65	5	009000166
10	14,3	25	12,9	8,65	5	009000167
11	16,0	25	14,3	8,65	5	009000168
12	17,4	25	16,0	8,65	5	009000169
13	18,0	25	16,4	9,60	5	009000170
14	19,3	25	17,9	10,20	5	009000171



900MB/SB12	€ 126,50	U	PC
4-5-5,5-6-7-8-9-10		1	009000179
11-12-13-14 mm			

900L

1/4" Dopsleutels zeskant, lange uitvoering



UNI/ISO 2725 DIN 3124

Ø mm	Ø mm	L mm	Ø1 mm	€	U	PC
4	6,5	50	12,0	10,40	5	009000181
4,5	7,0	50	12,0	10,40	5	009000182
5	7,5	50	12,0	10,40	5	009000183
5,5	8,5	50	12,0	10,40	5	009000184
6	9,5	50	12,0	10,40	5	009000185
7	10,5	50	12,0	10,40	5	009000186
8	12,0	50	12,0	10,40	5	009000187
9	13,0	50	13,0	10,40	5	009000188
10	14,0	50	14,0	10,80	5	009000189
11	16,0	50	16,0	10,80	5	009000190
12	17,5	50	17,5	10,80	5	009000191
13	17,5	50	17,5	10,80	5	009000192
14	20,0	50	20,0	10,80	5	009000193



900L/SB13	€ 159,00	U	PC
4-4,5-5-5,5-6-7-8-9-10-11-12-13-14 mm		1	009000203

900MB/L

Dopsleutels twaalfkant, lange uitvoering



UNI/ISO 2725 DIN 3124

Ø mm	Ø mm	L mm	Ø1 mm	€	Hand	Computer
5	8,0	50	12,0	16,50	3	009000211
6	9,3	50	12,0	16,50	3	009000212
7	10,9	50	12,0	16,50	3	009000213
8	11,6	50	12,0	16,50	3	009000214
9	13,0	50	12,0	16,50	3	009000215
10	14,3	50	12,8	17,60	3	009000216
11	16,0	50	14,2	17,60	3	009000217
12	17,4	50	15,5	17,60	3	009000218
13	18,0	50	16,2	18,10	3	009000219
14	19,0	50	17,1	18,30	3	009000220

900AS

Dopsleutels zeskant



Ø mm	Ø mm	L mm	Ø1 mm	€	Hand	Computer
5/32	8,8	25	11,9	4,80	5	009000349
3/16	7,7	25	11,9	4,80	5	009000340
7/32	8,8	25	11,9	4,80	5	009000345
1/4	9,6	25	11,9	4,80	5	009000350
9/32	10,2	25	11,9	4,80	5	009000355
5/16	11,3	25	11,9	4,80	5	009000360
11/32	12,7	25	11,6	4,80	5	009000365
3/8	14,0	25	12,9	4,80	5	009000370
7/16	15,3	25	14,5	4,80	5	009000375
1/2	17,5	25	16,4	5,00	5	009000380
9/16	19,0	25	17,9	5,10	5	009000385



900AS/SB11
3/16-7/32-5/32-1/4-9/32-5/16
11/32-3/8-7/16-1/2-9/16

€ 72,50 1 009000389

900AS/MB

Dopsleutels twaalfkant



SAE AS 954E

Ø mm	Ø mm	L mm	Ø1 mm	€	Hand	Computer
3/16	7,7	22	10,9	9,10	2	009000390
7/32	8,5	22	10,9	9,10	2	009000391
1/4	9,4	22	10,9	9,10	2	009000392
9/32	10,2	22	10,9	9,10	2	009000393
5/16	11,3	22	11,7	9,10	2	009000394
11/32	12,5	22	12,0	9,10	2	009000395
3/8	13,7	22	12,9	9,55	2	009000396

Ø mm	L mm	Ø1 mm	€	Hand	Computer	
7/16	15,6	22	14,3	9,55	2	009000397
1/2	17,2	22	16,4	10,90	2	009000398
9/16	18,8	24	17,9	10,90	2	009000399

900AS/L

Dopsleutels zeskant, lange uitvoering



SAE AS 954E

Ø mm	Ø mm	L mm	Ø1 mm	€	Hand	Computer
3/16	7,0	50	12,0	10,90	2	009000301
7/32	8,5	50	12,0	10,90	2	009000303
1/4	9,8	50	12,0	10,90	2	009000305
9/32	10,5	50	12,0	10,90	2	009000307
5/16	12,0	50	12,0	10,90	2	009000309
11/32	13,0	50	13,0	10,90	2	009000311
3/8	14,0	50	14,0	10,90	2	009000313
7/16	16,0	50	16,0	10,90	2	009000315
1/2	17,5	50	17,5	10,90	2	009000317
9/16	20,0	50	20,0	11,50	2	009000319

900AS/MBL

Dopsleutels twaalfkant, lange uitvoering



Ø mm	Ø mm	L mm	Ø1 mm	€	Hand	Computer
5/32	6,8	50	12,0	17,70	2	009000325
3/16	8,0	50	12,0	17,70	2	009000326
7/32	8,5	50	12,0	17,70	2	009000327
1/4	9,8	50	12,0	17,70	2	009000328
9/32	10,9	50	12,0	17,70	2	009000329
5/16	11,6	50	12,0	17,70	2	009000330
11/32	13,0	50	12,0	17,70	2	009000331
3/8	14,3	50	12,8	18,80	2	009000332
7/16	16,0	50	14,2	18,80	2	009000333
1/2	18,0	50	16,2	19,10	2	009000334
9/16	19,0	50	17,1	19,10	2	009000335

900U

Gearlock handdopsleutels



Ø mm	"	Ø	Ø	€	Hand	Computer
4	5/32	E5	M5	4,55	5	009001702
4,5	3/16	E6		4,55	5	009001703
5	13/64		M6	4,55	5	009001704
5,5	7/32	E7		4,55	5	009001705
6	1/4	E8	M8	4,55	5	009001706
7	9/32			4,55	5	009001707
8	5/16	E10	M10	4,55	5	009001708
9	11/32			4,55	5	009001709
10	3/8	E12	M12	4,55	5	009001710
11	7/16	E14	M14	4,55	5	009001711
12	15/32	E16		4,55	5	009001712
13	1/2		M16	4,60	5	009001713
14	9/16	E18	M18	4,65	5	009001714

14"



900U/SB13
4-4,5-5-5,5-6-7-8-9
10-11-12-13-14 mm
€ 81,00 1 009001750

900FTX

Dopsleutels voor Torx® schroeven

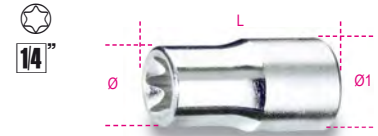

Ø mm	L mm	Ø1 mm	€	Hand	Computer	
E4	5,4	22	11,2	8,80	5	009000404
E5	6,7	22	11,2	8,80	5	009000405
E6	7,7	22	11,2	8,80	5	009000406
E7	8,3	22	11,2	8,80	5	009000407
E8	9,6	22	11,2	8,80	5	009000408
E10	11,3	22	12,0	8,80	5	009000410
E11	12,1	22	12,5	11,50	5	009000411
E12	12,9	23	12,9	11,50	5	009000412
E14	14,0	25	14,0	11,50	5	009000414



900FTX/SB9
E4-E5-E6-E7-E8
E10-E11-E12-E14
€ 104,00 1 009000419

900LP

Schroevendraaierdoppen voor sleufschroeven

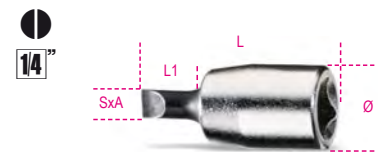

SxA mm	Ø mm	L mm	L1 mm	€	Hand	Computer
0,8x4	12	28	9	10,40	5	009000605
1x5,5	12	28	9	10,40	5	009000610
1,2x6,5	12	28	9	10,40	5	009000615
1,2x8	13	28	8	10,40	5	009000620
1,6x10	14	28	8	10,40	5	009000625

900MC/LP

Schroevendraaierdoppen voor sleufschroeven, gekleurd

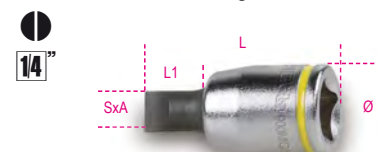

SxA mm	Ø mm	L mm	L1 mm	€	Hand	Computer
0,8x4	12	28	9	15,70	3	009002605
1,2x6,5	12	28	9	15,70	3	009002615
1,2x8	13	28	8	15,70	3	009002620

900PH

Schroevendraaierdoppen voor Phillips® kruiskopschroeven



PH	Ø mm	L mm	L1 mm	€	5	10
1	12	28	12	11,80	5	009000701
2	12	28	12	11,80	5	009000702
3	12	28	12	11,80	5	009000703
4	13	28	11	11,80	5	009000704



900PH/SB4
PH1-PH2-PH3-PH4
€ 57,00 1 009000708

900MC/PH

Schroevendraaierdoppen voor Phillips® kruiskop schroeven, gekleurd



PH	Ø mm	L mm	L1 mm	€	3
1	12	28	12	16,50	3 009002701
2	12	28	12	16,50	3 009002702
3	12	28	12	16,50	3 009002703

900PZ

Schroevendraaiers dopsleutels voor Pozidriv®-Supadriv® kruiskop schroeven



PZ	Ø mm	L mm	€	3
1	12	28	13,50	3 009000711
2	12	28	13,50	3 009000712
3	12	28	13,50	3 009000713

900ME

Schroevendraaierdoppen voor binnenzeskant schroeven



mm	Ø mm	L mm	L1 mm	€	5
2,5	12	25	4,5	9,80	5 009000502
3	12	25	5,0	9,80	5 009000503
4	12	25	5,6	9,80	5 009000504
5	12	25	6,3	9,80	5 009000505
6	12	25	7,6	9,80	5 009000506
7	13	25	7,2	9,80	5 009000507
8	13	25	8,0	9,80	5 009000508
10	13	25	8,7	12,10	5 009000510



900ME/SB8
2,5-3-4-5-6-7-8-10 mm
€ 96,00 1 009000518

900PE/AS

Schroevendraaiersleutels voor binnen zeskant schroeven



"	Ø mm	L mm	€	5
1/8	11,9	25	23,00	5 009000521
5/32	11,9	25	23,00	5 009000522
3/16	11,9	25	23,00	5 009000523
7/32	11,9	25	23,00	5 009000524
1/4	11,9	25	23,00	5 009000525
9/32	13,1	25	23,00	5 009000526
5/16	13,1	25	23,00	5 009000527

900PT

Dopsleutel voor 5-sterige kopschroeven



PT	Ø mm	L mm	L1 mm	€	5
PT10	12	28	12	20,50	5 009000750
PT15	12	28	12	20,50	5 009000755
PT20	12	28	12	20,50	5 009000760
PT25	12	28	12	20,50	5 009000765
PT27	12	28	12	20,50	5 009000767
PT30	12	28	12	20,50	5 009000770

900TX

Schroevendraaierdoppen voor Torx(R) schroeven



T	Ø mm	L mm	L1 mm	€	5
T6	12	28	12	15,50	5 009000717
T7	12	28	12	15,50	5 009000718
T8	12	28	12	15,70	5 009000719
T9	12	28	12	15,70	5 009000720
T10	12	28	12	15,70	5 009000721
T15	12	28	12	15,70	5 009000722
T20	12	28	12	15,70	5 009000723
T25	12	28	12	15,70	5 009000724
T27	12	28	12	15,70	5 009000725
T30	12	28	12	15,70	5 009000726
T40	12	28	12	15,70	5 009000727



900TX/SB8
T9-T10-T15-T20
T25-T27-T30-T40
€ 141,00 1 009000730

900MC/TX

Schroevendraaierdoppen voor Torx® schroeven, gekleurd



T	Ø mm	L mm	L1 mm	€	3
T10	12	28	12	16,90	3 009002721
T15	12	28	12	16,90	3 009002722
T20	12	28	12	16,90	3 009002723
T25	12	28	12	16,90	3 009002724
T27	12	28	12	16,90	3 009002725
T30	12	28	12	16,90	3 009002726
T40	12	28	12	16,90	3 009002727

900/16

Verlooptstuk 1/4" naar 3/8"



UNI/ISO 3316 DIN 3123

L mm	Ø mm	€	5
28	13,0	7,80	5 009000814

900/...

1/4" verlengstukken

1/4"

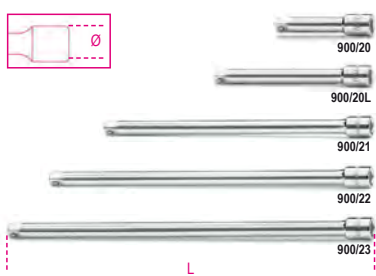

UNI/ISO 3316 DIN 3123

	L mm	Ø mm	€		
900/20	50	11,5	9,90	5	009000818
900/20L	100	11,5	9,95	5	009000819
900/21	150	11,5	10,90	5	009000822
900/22	250	11,5	16,30	5	009000823
900/23	350	11,5	19,00	5	009000824

900AN

1/4" verlengstukken, zwenkbaar

1/4"

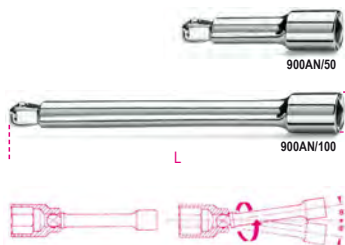

	L mm	Ø mm	€		
900AN/50	50	11,5	10,90	3	009000825
900AN/100	100	11,5	12,10	3	009000826

900FL

Flexibel verlengstuk

1/4"

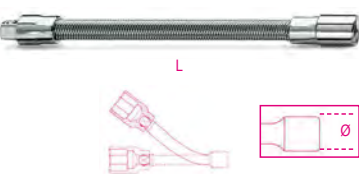

L mm	Ø mm	€		
150	12	16,20	3	009000828

900/25

1/4" cardangewricht

1/4"



UNI/ISO 3316 DIN 3123

L mm	Ø mm	€		
41	12,5	19,70	5	009000830

900BG/30C

1/4" steekhecht

1/4"



UNI/ISO 3315 DIN 3122

L mm	L1 mm	€		
128	20	9,50	5	009000833

900BG/30

1/4" steekhecht

1/4"



UNI/ISO 3315 DIN 3122

L mm	L1 mm	€		
176	68	9,75	5	009000834

900/32

1/4" flexibel steekhecht

1/4"



L mm	L1 mm	€		
280	154	23,80	2	009000839

900/35A

1/4" handgreep met kniegewricht

1/4"



UNI/ISO 3315 DIN 3122

L mm	L1 mm	€		
148	84	33,50	5	009000840

900M/35

1/4" wringijzer met kniegewricht

1/4"



UNI/ISO 3315
DIN 3122

L mm	€		
130	43,00	3	009000845



900/40

1/4" T-sleutel met cardangewricht

1/4"

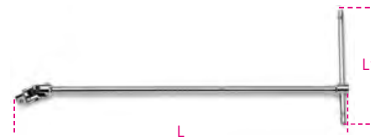

L mm	L1 mm	€		
390	145	44,50	3	009000843

900/42

1/4" wringstaaf met schuifstuk

1/4"



UNI/ISO 3315 DIN 3122

L mm	A mm	€		
115	22	10,80	5	009000854

900T/44

1/4" gebogen wringstaaf, met kracht handgreep

1/4"

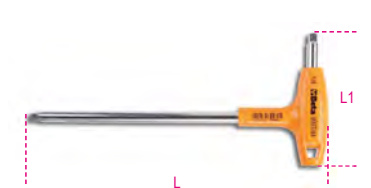

L mm	L1 mm	€		
238	105	16,20	2	009000860

900/55

1/4" omschakelbare ratel, 48 tands

1/4"



UNI/ISO 3315 DIN 3122

L mm	Ø mm	A mm	€	
125	25	29	51,50	5 009000870

900/C11Z

11 zeskant dopsleutels,
20 bits en 8 toebehoren

1/4"

1/4"



900/C11Z € 254,00 1 009000984

	861LP	0,5x3 - 0,8x5,5 - 1x5,5 - 1,2x6,5 mm
	861PE	3 - 4 - 5 - 6 - 8 mm
	861PH	0 - 1 - 2 - 3
	861TX	T8 - T10 - T15 - T20 T25 - T30 - T40
	895/1	
	900	5 - 5,5 - 6 - 7 - 8 - 9 - 10 11 - 12 - 13 - 14 mm
	900/16	□ 1/4 - ■ 3/8
	900/20	50 mm
	900/21	150 mm
	900/25	
	900BG/30	176 mm
	900/42	
	900/55Z	

350x150x50 mm - 1,2 kg

9899 900C11 € 15,00 1 098990132
Thermogevormde inlay, leeg

900/C12MR

12 zeskantdopsleutels,
20 bits en 7 toebehoren
met foam inleg,
in metalen kist

1/4"

1/4"



900/C12MR € 283,00 1 009000962

	900	4-5-5,5-6-7-8-9-10-11-12-13-14 mm
	900/20	50 mm
	900/21	150 mm
	900/25	
	900/42	115 mm
	900BG/30	128 mm
	900/58	
	895/1	
	861TX	T8-T10-T15-T20-T25-T30-T40
	861PH	PH0-PH1-PH2-PH3
	861LP	0,5-0,8-1-1,2 mm
	861PE	3-4-5-6-8 mm

350x150x50 mm 1,3 kg



900/C12MZ

12 zeskant dopsleutels,
20 bits en 7 toebehoren
in foam inlegbak

1/4"

1/4"



900/C12MZ € 257,00 1 009000983

	900	4-5-5,5-6-7-8-9-10-11-12-13-14 mm
	900/20	50 mm
	900/21	150 mm
	900/25	
	900/42	115 mm
	900BG/30	176 mm
	900/55Z	
	895/1	
	861TX	T8-T10-T15-T20-T25-T30-T40
	861PH	PH0-PH1-PH2-PH3
	861LP	0,5x3 - 0,8x5,5 - 1x5,5 - 1,2x6,5 mm
	861PE	3-4-5-6-8 mm

350x150x50 mm - 1,2 kg

900/C13-5

Doppendoos met 13 zeskant dopsleutels
en 5 toebehoren

1/4"



900/C13-5 € 199,50 1 009000953

	900	4 - 4,5 - 5 - 5,5 - 6 - 7 - 8 - 9 10 - 11 - 12 - 13 - 14 mm
	900/21	150 mm
	900/25	
	900BG/30	
	900/42	
	900/55	

270x120x45 mm - 1 kg

9899 900/C13-5 € 15,00 1 098990131
Thermogevormde inlay, leeg

900/C13-8

Doppendoos met 13 zeskant
dopsleutels en 8 toebehoren

1/4"



900/C13-8 € 251,00 1 009000954

	900	4 - 4,5 - 5 - 5,5 - 6 - 7 - 8 - 9 10 - 11 - 12 - 13 - 14 mm
	900/16	□ 1/4 - ■ 3/8
	900/20	50 mm
	900/21	150 mm
	900/25	
	900BG/30	
	900/35A	
	900/42	
	900/55	

270x120x45 mm - 1,1 kg

900MB/C19

Doppendoos met 11 twaalfkant
dopsleutels en 8 toebehoren

1/4"



900MB/C19 € 289,00 1 009000977

	900MB	5 - 5,5 - 6 - 7 - 8 - 9 - 10 - 11 12 - 13 - 14 mm
	900/16	□ 1/4 - ■ 3/8
	900/20	50 mm
	900/21	150 mm
	900/25	
	900BG/30	
	900/35A	
	900/42	
	900/55	

270x120x45 mm - 1,1 kg



900/C24

Doppendoos met 13 zeskant dopsleutels, 11 schroevendraaierdoppen en 6 toebehoren

1/4"



900/C24 € 325,00 1 009000956

- 900 4 - 4,5 - 5 - 5,5 - 6 - 7 - 8 - 9
10 - 11 - 12 - 13 - 14 mm
- 900LP 0,8x4 - 1,2x6,5 - 1,2x8 mm
- ⊕ 900PH PH1 - PH2 - PH3
- 900ME 3 - 4 - 5 - 6 - 8 mm
- 900/20 50 mm
- 900/21 150 mm
- 900/25
- 900BG/30
- 900/42
- ⊗ 900/55

270x120x45 mm - 1,1 kg

900MB/C28

Doppendoos met 11 twaalfkant dopsleutels, 11 schroevendraaierdoppen en 6 toebehoren

1/4"



900MB/C28 € 364,00 1 009000979

- 900MB 5 - 5,5 - 6 - 7 - 8 - 9 - 10 - 11
12 - 13 - 14 mm
- 900LP 0,8x4 - 1,2x6,5 - 1,2x8 mm
- ⊕ 900PH PH1 - PH2 - PH3
- 900ME 3 - 4 - 5 - 6 - 8 mm
- 900/20 50 mm
- 900/21 150 mm
- 900/25
- 900BG/30
- 900/42
- ⊗ 900/55

270x120x45 mm - 1,1 kg

900MC/C24

11 zeskant dopsleutels, 13 gekleurde schroevendraaierdoppen en 6 toebehoren

1/4"



900MC/C24 € 417,00 1 009002960

- 900MC 4 - 5 - 6 - 7 - 8 - 9
10 - 11 - 12 - 13 - 14 mm
- ⊕ 900MC/PH PH1 - PH2 - PH3
- ⊕ 900MC/TX T10 - T15 - T20 - T25 - T27 - T30
- T40
- 900MC/LP 0,8x4 - 1,2x6,5 - 1,2x8 mm
- 900/20 50 mm
- 900/21 150 mm
- 900/25
- 900BG/30
- 900/42
- ⊗ 900/55

270x120x45 mm - 1 kg

900MC/C32

Doppendoos met 11 gekleurde dopsleutels, 20 gekleurde bits en 7 toebehoren

1/4"



900MC/C32 € 264,00 1 009002963

- 900MC 4 - 5 - 6 - 7 - 8 - 9 - 10 - 11 - 12 - 13
- 14 mm
- 860LP 0,5x3 - 0,8x5,5 -
1,0x5,5 - 1,2x6,5 mm
- ⊕ 860PH 0 - 1 - 2 - 3
- 860PE 3 - 4 - 5 - 6 - 8 mm
- ⊕ 860TX T8 - T10 - T15 - T20 - T25 - T30 - T40
- 895/1
- 900/20
- 900/21
- 900/25
- 900BG/30
- 900/42
- ⊗ 900/55

270x120x45 mm - 1,2 kg

900U/C12M

Doppendoos met 12 gearlock dopsleutels, 20 bits en 7 toebehoren, in zachte foam inleg

1/4"

1/4"



900U/C12M € 258,00 1 009001792

- 900U ○ 4-5-5,5-6-7-8-9-10-11-12-13-14 mm
"5/32-3/16-13/64-7/32-1/4-9/32-5/16
11/32-3/8-7/16-15/32-1/2-9/16
⊕ E5-E6-E7-E8-E10-E12-E14-E16-E18
○ M5-M6-M8-M10-M12-M14-M16-M18
- 900/20 50 mm
- 900/21 150 mm
- 900/25
- 900/42 115 mm
- 900BG/30 176 mm
- ⊗ 900/55 125 mm
- 895/1 ○ 1/4 - □ 1/4
- 861LP 0,5x3 - 0,8x5,5 - 1,0x5,5 - 1,2x6,5 mm
- 861PE 3-4-5-6-8 mm
- ⊕ 861PH PH0-PH1-PH2-PH3
- ⊕ 861TX T8-T10-T15-T20-T25-T30-T40

350x150x50 mm - 1,2 kg

900AS/C10 - /MB-C17

Doppendoos met 10 dopsleutels en 7 toebehoren

14"



900AS/C10 € 232,50 1 009000961

- 900AS 3/16 - 7/32 - 1/4 - 9/32 - 5/16
11/32 - 3/8 - 7/16 - 1/2 - 9/16
- 900/20 50 mm
- 900/21 150 mm
- 900/25
- 900BG/30
- 900/35A
- 900/42
- 900/55

≡ 270x120x45 mm - 1,1 kg

900AS/MB-C17 € 280,00 1 009000981

- 900AS/MB 3/16 - 7/32 - 1/4 - 9/32 - 5/16
11/32 - 3/8 - 7/16 - 1/2 - 9/16
- 900/20 50 mm
- 900/21 150 mm
- 900/25
- 900BG/30
- 900/35A
- 900/42
- 900/55

≡ 270x120x45 mm - 1,1 kg

900AS/C17-MBM

Doppendoos met 10 twaalfkant dopsleutels en 7 toebehoren voor Aeronautical onderhoud

14"



900AS/C17-MBM € 305,00 1 009000982

- 900AS/MB 3/16 - 7/32 - 1/4 - 9/32 - 5/16
11/32 - 3/8 - 7/16 - 1/2 - 9/16
- 900/20 50 mm
- 900/21 150 mm
- 900/25
- 900BG/30
- 900M/35
- 900/42
- 900M/55

≡ 270x120x45 mm - 1,2 kg

900/C11HR

11 zeskant dopsleutels, 20 bits en 7 toebehoren in harde foam inleg, in metalen kist

• Ratel met draaibare handgreep

14"

14"



900/C11HR € 280,00 1 009000980

- 861LP 0,5x3-0,8x5,5-1x5,5-1,2x6,5 mm
- ⊕ 861PH PH0-PH1-PH2-PH3
- 861PE 3-4-5-6-8 mm
- ⊗ 861TX T8-T10-T15-T20-T25-T30-T40
- 895/1
- 900 5-5,5-6-7-8-9-10-11-12-13-14 mm
- 900/16 □ 1/4 - ■ 3/8
- 900/20 50 mm
- 900/21 150 mm
- 900/25
- 900/42
- 900BG/30
- 900/58

≡ 350x150x50 mm - 1,3 kg

902R/C6

6 verloopstukken voor dopsleutels



902R/C6 € 103,50 1 009020814

- 900/16 □ 1/4 - ■ 3/8
- 910/15 □ 3/8 - ■ 1/4
- 910/16 □ 3/8 - ■ 1/2
- 920/15 □ 1/2 - ■ 3/8
- 920/16 □ 1/2 - ■ 3/4
- 928/15 □ 3/4 - ■ 1/2

≡ 170x100x35 mm - 600 g

902A/C22

22 dopsleutels en 6 toebehoren in metalen kist

14"

12"



902A/C22 € 396,00 1 009020807

- 900 5-5,5-6-7-8-9-10-11-12-13 mm
- 900/20 50 mm
- 900/25
- 14" 900/55
- 920A 10-13-14-15-17-18-19
22-24-27-30-32 mm
- 920/21 125 mm
- 920/25
- 12" 920/55

≡ 420x185x60 mm - 3,5 kg

9899 902A/C22 € 15,00 1 098990133

Thermogevormde inlay, leeg

910A

Dopsleutels zeskant

38"

38"



UNI/ISO 2725 DIN 3124

6 mm	Ø mm	L mm	Ø1 mm	€	1
6	9,5	28	16,7	6,90	5 009100006
7	10,7	28	16,7	6,90	5 009100007
8	12,1	28	16,7	6,90	5 009100008
9	13,2	28	16,7	6,90	5 009100009
10	14,6	29	16,7	6,90	5 009100010
11	15,8	29	16,7	6,90	5 009100011
12	17,2	30	17,7	7,30	5 009100012
13	18,4	31	17,0	7,30	5 009100013
14	19,7	32	17,5	7,30	5 009100014
15	20,9	32	18,0	7,30	5 009100015
16	22,2	33	18,5	7,90	5 009100016
17	23,2	33	19,0	7,90	5 009100017
18	24,7	34	20,0	7,90	5 009100018
19	25,8	35	21,0	7,90	5 009100019
20	27,2	35	22,0	8,45	5 009100020
21	28,2	36	23,0	8,45	5 009100021
22	29,7	37	24,0	8,65	5 009100022

38"

38"



910A/SB17 € 155,50 1 009100030

6-7-8-9-10-11-12
13-14-15-16-17
18-19-20-21-22 mm

910B

Dopsleutels twaalfkant



UNI/ISO 2725 DIN 3124

mm	Ø	L	Ø1	€	Hand	Box
6	9,5	28	16,7	6,90	5	009100106
7	10,7	28	16,7	6,90	5	009100107
8	12,1	28	16,7	6,90	5	009100108
9	13,2	28	16,7	6,90	5	009100109
10	14,6	29	16,7	6,90	5	009100110
11	15,8	29	16,7	6,90	5	009100111
12	17,2	30	17,7	7,30	5	009100112
13	18,4	31	17,0	7,30	5	009100113
14	19,7	32	17,5	7,30	5	009100114
15	20,9	32	18,0	7,30	5	009100115
16	22,2	33	18,5	7,90	5	009100116
17	23,2	33	19,0	7,90	5	009100117
18	24,7	34	20,0	7,90	5	009100118
19	25,8	35	21,0	7,90	5	009100119
20	27,2	35	22,0	8,45	5	009100120
21	28,2	36	23,0	8,45	5	009100121
22	29,7	37	24,0	8,65	5	009100122



910B/SB17 € 155,50 1 009100130
6-7-8-9-10-11-12
13-14-15-16-17
18-19-20-21-22 mm

910AL

Dopsleutels, zeskant, lange uitvoering



UNI/ISO 2725 DIN 3124

mm	Ø	L	Ø1	€	Hand	Box
8	12,0	55	17	14,70	3	009100158
9	13,0	55	17	14,70	3	009100159
10	14,5	55	17	14,70	3	009100160
11	16,0	55	17	14,70	3	009100161
12	17,0	55	17	14,70	3	009100162
13	18,0	55	17	16,20	3	009100163
14	20,0	55	18	16,20	3	009100164
15	21,0	55	20	16,20	3	009100165
16	22,0	55	20	16,20	3	009100166
17	23,5	55	22	16,20	3	009100167
18	24,5	55	23	17,50	2	009100168
19	25,0	55	24	17,50	2	009100169
21	27,0	65	26	19,20	2	009100171
22	29,0	65	28	19,20	2	009100172



910AL/SB14 € 252,00 1 009100174
8-9-10-11-12-13-14
15-16-17-18-19-21-22 mm

910BL

Dopsleutels twaalfkant, lange uitvoering



UNI/ISO 2725 DIN 3124

mm	Ø	L	Ø1	€	Hand	Box
8	12,0	55	17	14,70	3	009100308
9	13,0	55	17	14,70	3	009100309
10	14,5	55	17	14,70	3	009100310
11	16,0	55	17	14,70	3	009100311
12	17,0	55	17	14,70	3	009100312
13	18,0	55	17	16,20	3	009100313
14	20,0	55	18	16,20	3	009100314
15	21,0	55	20	16,20	3	009100315
16	22,0	55	20	16,20	3	009100316
17	23,5	55	22	16,20	3	009100317
18	24,5	55	23	17,50	2	009100318
19	25,0	55	24	17,50	2	009100319
21	27,0	65	26	19,20	2	009100321
22	29,0	65	28	19,20	2	009100322



910BL/SB14 € 252,00 1 009100340
8-9-10-11-12-13
14-15-16-17-18
19-21-22 mm

910B/SN

Twaalfkant dopsleutels met cardangewricht



mm	Ø	L	Ø1	€	Hand	Box
10	14,5	48,5	19	40,50	2	009100230
11	15,8	49,5	19	40,50	2	009100231
12	17,0	50,0	19	40,50	2	009100232
13	18,3	51,0	19	40,50	2	009100233
14	19,5	51,0	19	42,50	2	009100234
15	20,8	53,5	19	42,50	2	009100235
16	22,0	53,5	19	42,50	2	009100236
17	23,3	54,5	19	42,50	2	009100237
18	24,5	54,5	19	43,50	2	009100238
19	25,8	56,5	19	43,50	2	009100239

910A/AS

Dopsleutels zeskant



"	Ø	L	Ø1	€	Hand	Box
1/4	10,3	26	17,3	8,35	5	009100276
5/16	11,9	26	17,3	8,35	5	009100278
11/32	13,3	26	17,3	8,35	5	009100279
3/8	13,9	26	17,3	8,35	5	009100280
7/16	15,8	26	17,3	8,35	5	009100281
1/2	17,9	26	17,3	8,80	5	009100283
9/16	19,5	27	18,5	8,80	5	009100284
19/32	20,6	27	19,5	8,80	5	009100285
5/8	21,9	28	20,0	9,25	5	009100286
11/16	24,6	30	22,5	9,25	5	009100287
3/4	25,9	30	23,5	9,25	5	009100289
13/16	27,9	32	26,0	10,30	5	009100291
7/8	29,6	32	26,5	10,80	5	009100292



910A-AS/SB13 € 139,50 1 009100295
1/4-5/16-11/32-3/8-7/16
1/2-9/16-19/32-5/8-11/16
3/4-13/16-7/8

910AS

Dopsleutels twaalfkant

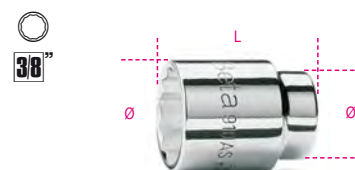

"	Ø	L	Ø1	€	Hand	Box
1/4	9,5	28	16,7	8,35	5	009100201
5/16	12,1	28	16,7	8,35	5	009100202
11/32	13,2	28	16,7	8,35	5	009100203
3/8	14,6	29	16,7	8,35	5	009100204
7/16	15,8	29	16,7	8,35	5	009100205
1/2	18,4	31	17,0	8,80	5	009100206
9/16	19,7	32	17,5	8,80	5	009100207
19/32	20,9	32	18,0	8,80	5	009100208
5/8	22,2	33	18,5	9,25	5	009100209
11/16	24,7	34	20,0	9,25	5	009100210
3/4	25,8	35	21,0	9,25	5	009100211
13/16	28,2	36	23,0	10,30	5	009100212
7/8	29,7	37	24,0	10,80	5	009100213



910AS/SB13 € 139,50 1 009100215
1/4-5/16-11/32-3/8-7/16
1/2-9/16-19/32-5/8-11/16
3/4-13/16-7/8

910AS/L

Dopsleutels twaalfkant, lange uitvoering

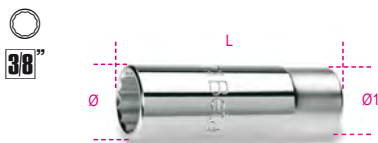

"	Ø mm	L mm	Ø1 mm	€		
1/4	10	55	17	17,90	3	009100350
5/16	12	55	17	17,90	3	009100351
3/8	14	55	17	17,90	3	009100352
7/16	16	55	17	17,90	3	009100353
1/2	18	55	17	20,00	3	009100354
9/16	20	55	18	20,00	3	009100355
19/32	21	55	20	20,70	3	009100356
5/8	22	55	20	20,70	3	009100357
11/16	23	55	22	20,70	3	009100359
3/4	25	55	24	22,40	3	009100360
13/16	27	65	26	26,00	3	009100362
7/8	29	65	28	26,00	3	009100363



910ASL/SB12	€		
1/4-5/16-3/8-7/16 1/2-9/16-19/32-5/8-11/16 3/4-13/16-7/8	269,00	1	009100365

910AS/SN

Twaalfkant dopsleutels met cardangewricht



* SAE AS 954E

"	Ø mm	L mm	Ø1 mm	€		
* 3/8	14,0	48,0	19	43,00	2	009100260
* 7/16	15,8	51,0	19	43,00	2	009100261
* 1/2	18,3	51,0	19	43,00	2	009100262
* 9/16	19,5	51,0	19	43,50	2	009100263
* 5/8	22,0	53,5	19	43,50	2	009100264
11/16	24,5	54,5	19	46,00	2	009100265
3/4	25,8	56,5	19	46,00	2	009100266

910FTX

Dopsleutels voor Torx® schroeven

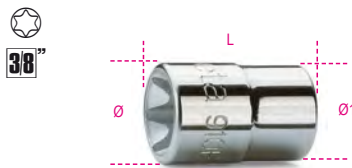

"	Ø mm	L mm	Ø1 mm	€		
E4	6,2	26	17,3	9,75	5	009100404
E5	7,0	26	17,3	9,75	5	009100405
E6	8,3	26	17,3	9,75	5	009100406
E7	8,9	26	17,3	9,75	5	009100407
E8	9,9	26	17,3	9,75	5	009100408
E10	12,0	26	17,3	9,75	5	009100410
E11	13,3	26	17,3	9,75	5	009100411
E12	14,5	26	17,3	9,75	5	009100412
E14	15,8	26	17,3	9,75	5	009100414
E16	18,0	26	17,3	10,10	5	009100416
E18	19,5	26	18,5	11,00	3	009100418
E20	21,9	26	20,0	11,00	3	009100420



910FTX/SB9	€		
E4-E5-E6-E7-E8 E10-E12-14-E16	104,50	1	009100430

910FTX/L

Dopsleutels voor Torx® schroeven, lange uitvoering



"	Ø mm	L mm	Ø1 mm	€		
E4	6,2	55	17,3	22,00	3	009100440
E5	7,0	55	17,3	22,00	3	009100441
E6	8,3	55	17,3	22,00	3	009100442
E7	8,9	55	17,3	22,00	3	009100443
E8	9,9	55	17,3	22,00	3	009100444
E10	12,0	55	17,3	22,00	3	009100445



910FTX-L/SB6	€		
E4-E5-E6 E7-E8-E10	144,50	1	009100449

910FTX/XL

Dopsleutels voor Torx® schroeven, extra-lange uitvoering



"	Ø mm	L mm	Ø1 mm	€		
E6	8,0	200	18	18,90	2	009100766
E7	8,0	200	18	18,90	2	009100767
E8	10,0	200	18	18,90	2	009100768
E10	14,0	200	18	18,90	2	009100770
E11	14,0	200	18	18,90	2	009100771
E12	14,0	200	18	18,90	2	009100772

"	Ø mm	L mm	Ø1 mm	€		
E14	17,0	200	18	20,70	2	009100774
E16	18,6	200	18	20,70	2	009100776
E18	21,5	200	18	21,90	2	009100778
E20	21,5	200	18	21,90	2	009100780

910FTX-XL/C10

10-delig set van dopsleutels voor bouten met Torx® profiel, lange uitvoering, in kunststof koffer



910FTX-XL-C10	€		
E6-E7-E8-E10-E11- E12-E14-E16-E18-E20	198,50	1	009100976

255x195x62 mm - 2,3 kg

910LP

Schroevendraaierdoppen voor sleufschroeven

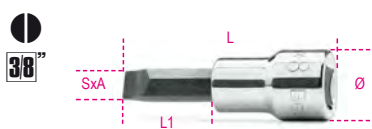

SxA mm	Ø mm	L mm	L1 mm	€		
1x5,5	18,5	54	24	17,70	2	009100452
1,2x6,5	18,5	54	24	17,70	2	009100453
1,2x8	18,5	54	24	17,70	2	009100454
1,6x9	18,5	54	24	17,70	2	009100456

910PH

Schroevendraaierdoppen voor Phillips® kruiskopschroeven



PH	Ø mm	L mm	L1 mm	€		
1	18,5	48	18	17,00	2	009100471
2	18,5	48	18	17,00	2	009100472
3	18,5	48	18	17,00	2	009100473
4	18,5	48	18	17,00	2	009100474



910PH/SB4	€		
PH1-PH2-PH3-PH4	78,00	1	009100478



910PE

Schroevendraaierdoppen voor binnenzeskant schroeven



DIN 7422

mm	Ø mm	L mm	L1 mm	€	U	L
3	18,5	50	20	15,20	5	009100490
4	18,5	50	20	15,20	5	009100492
5	18,5	50	20	15,20	5	009100494
6	18,5	50	20	15,20	5	009100496
7	18,5	50	20	15,20	5	009100497
8	18,5	50	20	15,20	5	009100498
9	18,5	50	20	15,20	5	009100499
10	18,5	50	20	15,20	5	009100500



910PE/SB7
3-4-5-6-7-8-10 mm

910BP

Dopsleutels met kogelkopaansluiting voor binnenzeskant schroeven



mm	L mm	L1 mm	€	U	L
4L	92	62	17,20	3	009100584
5L	92	62	17,20	3	009100585
6L	92	62	17,20	3	009100586
7L	92	62	17,20	3	009100587
8L	92	62	17,20	3	009100588
10L	132	102	18,90	3	009100590



910BP/SB6L
4L-5L-6L-7L-8L-10L mm

910ME

Schroevendraaierdoppen voor binnenzeskant schroeven



mm	Ø mm	L mm	L1 mm	€	U	L
4	18	62	15	17,30	5	009100504
5	18	62	15	17,30	5	009100505
6	18	62	15	17,30	5	009100506
7	18	62	15	17,60	5	009100507
8	19	62	15	17,60	5	009100508
10	20	62	15	17,60	5	009100510
12	20	62	15	17,60	5	009100512



910ME/SB5
4-5-6-8-10 mm

910PE/AS

Schroevendraaierdoppen voor binnen zeskant schroeven



"	Ø mm	L mm	L1 mm	€	U	L
1/8	18,5	50	20	26,50	2	009100531
5/32	18,5	50	20	26,50	2	009100532
3/16	18,5	50	20	26,50	2	009100533
7/32	18,5	50	20	26,50	2	009100534
1/4	18,5	50	20	26,50	2	009100535
5/16	18,5	50	20	26,50	2	009100536
3/8	18,5	50	20	30,50	2	009100537

910PT

Dopsleutel voor 5-sterige kopschroeven

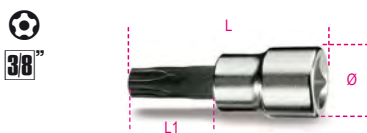

"	Ø mm	L mm	L1 mm	€	U	L
PT40	20	50	20	23,50	3	009100540
PT45	20	50	20	24,00	3	009100545
PT50	20	50	20	27,00	3	009100550



910PT/SB8
PT10-PT15-PT20-PT25
PT30-PT40-PT45-PT50

910TX

Schroevendraaierdoppen voor Torx® schroeven



"	Ø mm	L mm	L1 mm	€	U	L
T15	18,5	50	20	18,70	5	009100519
T20	18,5	50	20	18,70	5	009100520
T25	18,5	50	20	18,70	5	009100521
T27	18,5	50	20	18,70	5	009100522
T30	18,5	50	20	18,70	5	009100523
T40	18,5	50	20	18,70	5	009100524
T45	18,5	50	20	18,70	3	009100525
T50	18,5	50	20	18,70	3	009100526



910TX/SB6
T15-T20-T25
T27-T30-T40

910XZN

Schroevendraaierdoppen met XZN® profiel



"	L mm	€	U	L
M4	50	18,80	3	009100559
M5	50	18,80	3	009100560
M6	50	18,80	3	009100561
M8	50	18,80	3	009100563
M10	50	19,90	3	009100565

910CF

3/8" kraaienpoot steeksleutels



"	A mm	L mm	€	U	L
10	21,3	32,3	12,10	2	009100135
11	23,1	34,3	12,10	2	009100136
12	25,5	36,2	13,70	2	009100137
13	26,9	37,4	13,70	2	009100138
14	30,2	40,0	14,50	2	009100139
15	33,3	41,3	15,10	2	009100140
16	33,3	41,3	16,60	2	009100141
17	38,1	46,5	19,00	2	009100142
18	38,1	46,5	19,00	2	009100143
19	39,6	48,0	20,60	2	009100144



910CF/SB10
10-11-12-13-14-15
16-17-18-19 mm

910/15

Verloopdop 3/8" naar 1/4"



UNI/ISO 3316 DIN 3123

L mm	Ø mm	€	U	L
30	17,0	10,40	5	009100810



Altijd het toegestane koppel volgen en gelijkmatig en progressief aantrekken om het breken en eventuele verwondingen te voorkomen.

910/16

Verlooptop 3/8" naar 1/2"



UNI/ISO 3316 DIN 3123

L mm	Ø mm	3/8"	1/2"	€	3	009100814
32	18,0			11,10	5	009100814

910/20 - 910/21 - 910/22

3/8" verlengstukken

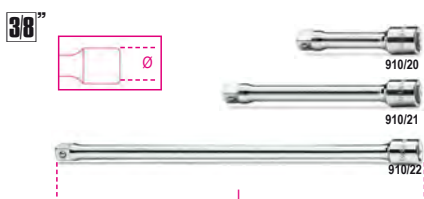

UNI/ISO 3316 DIN 3123

	L mm	Ø mm	€	3	009100820
910/20	75	17	8,95	5	009100820
910/21	125	17	13,00	5	009100822
910/22	250	17	17,00	5	009100826

910AN

3/8" verlengstukken, zwenkbaar

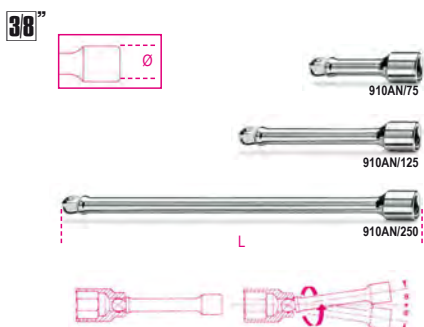

	L mm	Ø mm	€	3	009100827
910AN/75	75	17	13,10	3	009100827
910AN/125	125	17	16,80	3	009100828
910AN/250	250	17	25,00	3	009100829

910/25

3/8" cardangewricht



UNI/ISO 3316 DIN 3123

L mm	Ø mm	€	3	009100830
54,6	19	23,70	5	009100830

910M/35

3/8" wringijzer met kniegewricht



UNI/ISO 3315 DIN 3122

L mm	€	3	009100839
250	66,00	3	009100839

910/36A

3/8" handgreep met kniegewricht



UNI/ISO 3315 DIN 3122

L mm	L1 mm	€	3	009100845
255	154	46,50	3	009100845

910/40

3/8" T-sleutel met cardangewricht

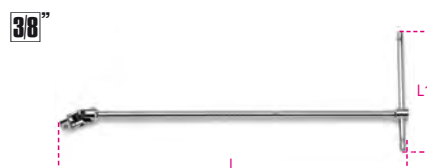

L mm	L1 mm	€	3	009100850
420	175	48,00	3	009100850

910/42

3/8" wringstaaf

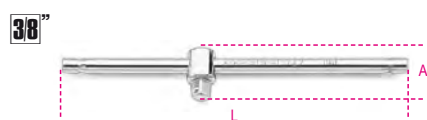

UNI/ISO 3315 DIN 3122

L mm	A mm	€	3	009100854
210	30,5	15,20	5	009100854

910/46

3/8" omslag met handgreep

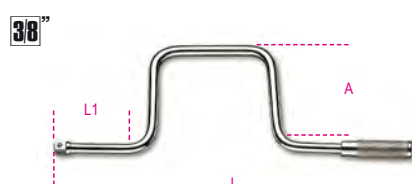

UNI/ISO 3315 DIN 3122

L mm	L1 mm	A mm	€	1	009100862
315	80	115	32,00	1	009100862

910/55

3/8" omschakelbare ratel, 72 tands



UNI/ISO 3315 DIN 3122

L mm	Ø mm	A mm	€	3	009100882
200	30	33	55,50	3	009100882

910/55Q

3/8" omschakelbare ratel, 48 tands



UNI/ISO 3315 DIN 3122

L mm	Ø mm	A mm	€	3	009100885
200	30	33	55,50	3	009100885

Zie de tabel na item 929/C8 voor de draaiende onderdelen van het ratelmechanisme

910M/55

3/8" omschakelbare ratel met metalen handgreep



DIN 3122 - UNI ISO 3315

L mm	Ø mm	A mm	€	2	009100875
178	30	26	78,50	2	009100875

Beta

910M/56

3/8" omschakelbare ratel
met metalen handgreep en kniegewricht



L mm	Ø mm	A mm	€	1	009100887
265	31	29	106,00	2	009100887

910/58

3/8" omschakelbare ratel
met draaibare handgreep,
52 tands ratelmechanisme

- Werking door het draaien van de handgreep
- Dop vergrendelingsknop
- Omschakelen door ring op de ratelkop
- Twee componenten handgreep



L mm	Ø mm	A mm	€	1	009100884
222	37	38,5	85,50	1	009100884

910.../C10

Doppendoos met 10 dopsleutels
en 2 toebehoren



910A/C10	€	1	009100909
	178,50	1	009100909

910A	6 - 7 - 8 - 10 - 11 - 12 13 - 14 - 17 - 19 mm
910/21	125 mm
910/55	

335x120x45 mm - 1,3 kg

910B/C10	€	1	009100910
	178,50	1	009100910

910B	6 - 7 - 8 - 10 - 11 - 12 13 - 14 - 17 - 19 mm
910/21	125 mm
910/55	

270x120x45 mm - 1,3 kg

910A/C16...

Doppendoos met 16 zeskant dopsleutels
en 5 toebehoren



910A/C16	€	1	009100936
	288,00	1	009100936

910A	6 - 7 - 8 - 9 - 10 - 11 - 12 - 13 14 - 15 - 16 - 17 - 18 - 19 21 - 22 mm
910/21	125 mm
910/22	250 mm
910/25	
910/42	
910/55	

335x145x60 mm - 2,3 kg

9899 910C16	€	1	098990134
	15,00	1	098990134

Thermogevormde inlay, leeg

910A/C16Q	€	1	009100932
	288,00	1	009100932

910A	6 - 7 - 8 - 9 - 10 - 11 - 12 - 13 14 - 15 - 16 - 17 - 18 - 19 21 - 22 mm
910/21	125 mm
910/22	250 mm
910/25	
910/42	
910/55Q	

335x145x60 mm - 2,3 kg

9899 910C16	€	1	098990134
	15,00	1	098990134

Thermogevormde inlay, leeg

910B/C16...

Doppendoos met 16 twaalfkant dopsleutels
en 5 toebehoren



910B/C16	€	1	009100937
	288,00	1	009100937

910B	6 - 7 - 8 - 9 - 10 - 11 - 12 - 13 14 - 15 - 16 - 17 - 18 - 19 21 - 22 mm
910/21	125 mm
910/22	250 mm
910/25	
910/42	
910/55	

335x145x60 mm - 2,3 kg

9899 910C16	€	1	098990134
	15,00	1	098990134

Thermogevormde inlay, leeg

910B/C16Q	€	1	009100933
	288,00	1	009100933

910B	6 - 7 - 8 - 9 - 10 - 11 - 12 - 13 14 - 15 - 16 - 17 - 18 - 19 21 - 22 mm
910/21	125 mm
910/22	250 mm
910/25	
910/42	
910/55Q	

335x145x60 mm - 2,3 kg

9899 910C16	€	1	098990134
	15,00	1	098990134

Thermogevormde inlay, leeg

910A/C17

Doppendoos met 17 zeskant dopsleutels
en 9 toebehoren



910A/C17	€	1	009100938
	436,00	1	009100938

910A	6 - 7 - 8 - 9 - 10 - 11 - 12 - 13 14 - 15 - 16 - 17 - 18 - 19 - 20 21 - 22 mm
910/15	□ 3/8 - ■ 1/4
910/16	□ 3/8 - ■ 1/2
910/21	125 mm
910/22	250 mm
910/25	
910/36A	
910/42	
910/46	
910/55	

420x280x60 mm - 4,0 kg



Beta

910.../C29

Doppendoos met 17 dopsleutels,
12 schroevendraaier-doppen
en 5 toebehoren

38"



910A/C29 € 504,00 1 009100944

- 910A 6 - 7 - 8 - 9 - 10 - 11 - 12 - 13
14 - 15 - 16 - 17 - 18 - 19 - 20
21 - 22 mm
- 910LP 1x5,5 - 1,2x6,5 - 1,2x8 mm
- ⊕ 910PH PH1 - PH2 - PH3
- 910PE 3 - 4 - 5 - 6 - 8 - 10 mm
- 910/21 125 mm
- 910/22 250 mm
- 910/25
- 910/42
- 910/55

420x185x60 mm - 3,5 kg

910B/C29 € 504,00 1 009100945

- 910B 6 - 7 - 8 - 9 - 10 - 11 - 12 - 13
14 - 15 - 16 - 17 - 18 - 19 - 20
21 - 22 mm
- 910LP 1x5,5 - 1,2x6,5 - 1,2x8 mm
- ⊕ 910PH PH1 - PH2 - PH3
- 910PE 3 - 4 - 5 - 6 - 8 - 10 mm
- 910/21 125 mm
- 910/22 250 mm
- 910/25
- 910/42
- 910/55

420x185x60 mm - 3,5 kg

910AS/C13...

Doppendoos met 13 twaalfkant
dopsleutels en 5 toebehoren

38"



910AS/C13 € 286,00 1 009100925

- 910AS 1/4 - 5/16 - 11/32 - 3/8 - 7/16
1/2 - 9/16 - 19/32 - 5/8 - 11/16
3/4 - 13/16 - 7/8
- 910/21 125 mm
- 910/22 250 mm
- 910/42
- 910/25
- 910/55

335x145x60 mm - 2,3 kg

910AS/MBM-C18

Doppendoos met 13 twaalfkant
dopsleutels en 5 toebehoren

38"



910AS/MBM-C18 € 309,00 1 009100926

- 910AS 1/4 - 5/16 - 11/32 - 3/8 - 7/16
1/2 - 9/16 - 19/32 - 5/8 - 11/16
3/4 - 13/16 - 7/8
- 910/21 125 mm
- 910/22 250 mm
- 910/25
- 910/42
- 910M/55

335x145x60 mm - 2,5 kg

910A/C16HR

16 zeskant dopsleutels en 5 toebehoren

38"



910A/C16HR € 318,00 1 009100935

- 910A 6 - 7 - 8 - 9 - 10 - 11 - 12 - 13
14 - 15 - 16 - 17 - 18 - 19
21 - 22 mm
- 910/21 125 mm
- 910/22 250 mm
- 910/25
- 910/42 210 mm
- 910/58

335x145x60 mm - 2,4 kg

Beta

920A

Dopsleutels zeskant



UNI/ISO 2725 DIN 3124

mm	Ø mm	L mm	Ø1 mm	€		
8	12,4	38	21,7	6,90	10	009200008
9	13,5	38	21,7	6,90	10	009200009
10	14,9	38	21,7	6,90	10	009200010
11	16,1	38	21,7	6,90	10	009200011
12	17,5	38	21,7	6,90	10	009200012
13	18,7	38	21,7	7,30	10	009200013
14	20,1	38	21,7	7,30	10	009200014
15	21,5	38	22,5	7,30	10	009200015
16	22,7	38	23,7	7,85	10	009200016
17	24,1	38	23,1	7,85	10	009200017
18	25,3	39	24,0	7,85	10	009200018
19	26,6	39	24,0	7,85	10	009200019
20	27,8	40	25,0	8,75	5	009200020
21	28,8	40	25,0	8,75	5	009200021
22	29,9	41	26,0	8,75	5	009200022
23	30,8	42	26,0	9,75	5	009200023
24	32,2	43	27,0	9,75	5	009200024
25	33,2	44	27,0	9,75	5	009200025
26	34,7	45	28,0	10,10	5	009200026
27	36,2	46	29,0	10,10	5	009200027
28	37,2	47	30,0	10,10	5	009200028
29	38,6	48	31,0	10,50	5	009200029
30	40,2	48	32,0	10,50	5	009200030
32	42,3	49	34,0	11,10	5	009200032



920A/SB13 € 123,00 1 009200040

10-11-12-13-14-15-16
17-18-19-20-21-22 mm



920A/SB8 € 97,00 1 009200042

23-24-25-26-27-28-30-32 mm

Beta

920MC

Zeskant dopsleutels, gekleurd

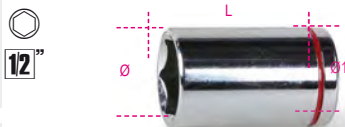

Ø mm	Ø mm	L mm	Ø1 mm	€	U	1
8	13,2	38	22	7,40	5	009202008
10	15,3	38	22	7,40	5	009202010
11	16,5	38	22	7,40	5	009202011
12	17,8	38	22	7,40	5	009202012
13	19,0	38	22	7,80	5	009202013
14	20,3	38	22	7,80	5	009202014
15	21,6	38	22	7,80	5	009202015
16	23,0	38	23	8,65	5	009202016
17	23,9	38	24	8,65	5	009202017
18	25,0	38	25	8,65	5	009202018
19	26,5	38	24	8,65	5	009202019
21	28,8	38	27	9,50	3	009202021
22	29,9	40	28	9,50	3	009202022
24	32,8	40	30	10,80	3	009202024

920B

Dopsleutels twaalfkant

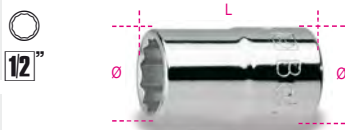

UNI/ISO 2725 DIN 3124

Ø mm	Ø mm	L mm	Ø1 mm	€	U	1
8	12,4	38	21,7	6,90	10	009200108
9	13,5	38	21,7	6,90	10	009200109
10	14,9	38	21,7	6,90	10	009200110
11	16,1	38	21,7	6,90	10	009200111
12	17,5	38	21,7	6,90	10	009200112
13	18,7	38	21,7	7,30	10	009200113
14	20,1	38	21,7	7,30	10	009200114
15	21,5	38	22,5	7,30	10	009200115
16	22,7	38	23,7	7,85	10	009200116
17	24,1	38	23,1	7,85	10	009200117
18	25,3	39	24,0	7,85	10	009200118
19	26,6	39	24,0	7,85	10	009200119
20	27,8	40	25,0	8,75	5	009200120
21	28,8	40	25,0	8,75	5	009200121
22	29,9	41	26,0	8,75	5	009200122
23	30,8	42	26,0	9,75	5	009200123
24	32,2	43	27,0	9,75	5	009200124
25	33,2	44	27,0	9,75	5	009200125
26	34,7	45	28,0	10,10	5	009200126
27	36,2	46	29,0	10,10	5	009200127
28	37,2	47	30,0	10,10	5	009200128
29	38,6	48	31,0	10,50	5	009200129
30	40,2	48	32,0	10,50	5	009200130
32	42,3	49	33,9	11,10	5	009200132



920B/SB13 123,00 1 009200140
10-11-12-13-14-15-16
17-18-19-20-21-22 mm



920B/SB8 97,00 1 009200142
23-24-25-26-27
28-30-32 mm

920AL

Dopsleutel, zeskant lange



UNI/ISO 2725 DIN 3124

Ø mm	Ø mm	L mm	Ø1 mm	€	U	1
10	14,7	77	21	18,00	5	009200626
12	17,8	77	21	18,00	5	009200627
13	19,0	77	22	18,00	5	009200628
14	20,3	77	22	18,00	5	009200629
15	21,5	77	22	18,00	5	009200630
16	22,8	77	22	19,40	5	009200631
17	24,0	77	23	19,40	5	009200632
18	25,0	77	24	20,50	5	009200633
19	26,5	77	25	20,50	5	009200634
21	29,0	77	27	22,80	5	009200635
22	30,0	77	28	22,80	5	009200636
23	31,5	77	29	22,80	5	009200637
24	32,8	77	30	25,50	5	009200638
27	36,5	77	33	26,50	3	009200639
30	40,0	77	36	32,50	3	009200640
32	42,8	77	38	33,00	3	009200641
36	48,0	77	41	53,50	3	009200642



920AL/SB11 235,50 1 009200644
10-12-13-14-15-16
17-18-19-21-22 mm

920BL

Dopsleutels twaalfkant, lange uitvoering



UNI/ISO 2725 DIN 3124

Ø mm	Ø mm	L mm	Ø1 mm	€	U	1
10	14,7	77	21	18,00	5	009200310
12	17,8	77	21	18,00	5	009200312
13	19,0	77	22	18,00	5	009200313
14	20,3	77	22	18,00	5	009200314
15	21,5	77	22	18,00	5	009200315
16	22,8	77	22	19,40	5	009200316
17	24,0	77	23	19,40	5	009200317
18	25,0	77	24	20,50	5	009200318
19	26,5	77	25	20,50	5	009200319
21	29,0	77	27	22,80	5	009200321
22	30,0	77	28	22,80	5	009200322
23	31,5	77	29	22,80	5	009200323
24	32,8	77	30	25,50	5	009200324
27	36,5	77	33	26,50	3	009200327
30	40,0	77	36	32,50	3	009200330
32	42,8	77	38	33,00	3	009200332
36	48,0	77	41	53,50	3	009200336



920BL/SB11 235,50 1 009200338
10-12-13-14-15-16-17-18
19-21-22 mm

920A/AS

Dopsleutels zeskant

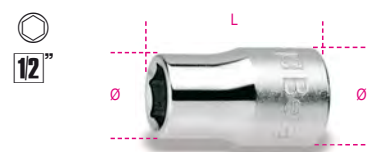

Ø mm	Ø mm	L mm	Ø1 mm	€	U	1
3/8	14,6	37	21	8,00	2	009200270
7/16	16,5	37	21	8,00	3	009200272
1/2	19,0	37	22	8,05	3	009200273
9/16	20,3	37	22	8,05	3	009200274
19/32	21,0	37	22	8,75	3	009200275
5/8	22,8	37	22	8,75	3	009200276
11/16	25,0	37	24	9,05	3	009200277
3/4	26,5	38	25	9,05	3	009200279
25/32	28,0	38	26	9,95	3	009200280
13/16	29,0	38	27	9,95	3	009200281
7/8	30,0	40	28	9,95	3	009200282
15/16	32,8	42	30	10,60	3	009200284
1	35,0	42	32	10,60	3	009200285
1.1/16	36,5	43	33	11,60	2	009200287
1.1/8	39,0	43	35	12,10	2	009200289
1.3/16	41,0	46	36	13,30	2	009200290
1.1/4	42,8	46	38	13,20	2	009200292



920A-AS/SB11 120,00 1 009200295
3/8-7/16-1/2-9/16-5/8
11/16-3/4-13/16-7/8
15/16-1

920AS

Dopsleutels twaalfkant



Ø mm	Ø mm	L mm	Ø1 mm	€	U	1
3/8	14,9	38	21,7	8,00	3	009200201
7/16	16,1	38	21,7	8,00	3	009200202
1/2	18,7	38	21,7	8,05	3	009200203
9/16	20,1	38	21,7	8,05	3	009200204
5/8	22,7	38	22,5	8,75	3	009200206
19/32	21,5	38	23,7	8,75	3	009200207
11/16	25,3	39	24,0	9,05	3	009200208
3/4	26,6	39	24,0	9,05	3	009200209
25/32	27,8	40	25,0	9,95	3	009200210
13/16	28,8	40	25,0	9,95	3	009200211
7/8	29,9	41	26,0	9,95	3	009200212
15/16	32,2	43	27,0	10,60	3	009200214
1	34,2	45	28,0	10,60	3	009200216
1.1/16	36,2	46	29,0	11,60	2	009200217
1.1/8	38,6	48	31,0	12,10	2	009200218
1.3/16	40,2	48	32,0	13,30	2	009200219
1.1/4	42,3	49	33,5	13,20	2	009200220



920AS/SB11 120,00 1 009200225
3/8-7/16-1/2-9/16-5/8
11/16-3/4-13/16-7/8
15/16-1

920AS/L

Dopsleutels twaalfkant, lange uitvoering



"	Ø mm	L mm	Ø1 mm	€		
1/2	19,0	77	22	26,00	2	009200352
9/16	20,3	77	22	26,00	2	009200353
5/8	22,8	77	22	26,00	2	009200355
11/16	25,0	77	24	26,50	2	009200357
3/4	26,5	77	25	28,50	2	009200358
13/16	29,0	77	27	33,50	2	009200360
7/8	30,0	77	28	33,50	2	009200361
15/16	32,8	77	30	34,50	2	009200362
1	35,0	77	32	35,50	2	009200363
1.1/16	36,5	77	33,0	40,00	2	009200364
1.1/8	37,8	77	34	41,00	2	009200365



920ASL/SB11 € 371,00 1 009200369
 1/2-9/16-5/8-11/16
 3/4-13/16-7/8-15/16
 1-1.1/8-1.1/16

920U

Gearlock dopsleutels



mm	"	Ø	Ø1	L mm	€		
10	3/8	E12	M12	38	7,25	5	009201710
11	7/16	E14	M14	38	7,25	5	009201711
12	15/32	E16		38	7,25	5	009201712
13	1/2		M16	38	7,60	5	009201713
14	9/16	E18	M18	38	7,60	5	009201714
15	19/32			38	7,60	5	009201715
16	5/8	E20		38	8,25	5	009201716
17				38	8,25	5	009201717
18		E22		38	8,25	5	009201718
19	3/4	E24		38	8,25	5	009201719
20	25/32			38	9,05	3	009201720
21				38	9,05	3	009201721
22	7/8			38	9,05	3	009201722
24	15/16			38	10,40	3	009201724
27	1.1/16			42	10,90	3	009201727
30	1.1/8			44	11,50	3	009201730
32	1.1/4			44	12,00	3	009201732



920U/SB13 € 127,50 1 009201740
 10-11-12-13-14-15-16
 17-18-19-20-21-22 mm



920U/SB4 € 55,00 1 009201744
 24-27-30-32 mm

920FTX

Dopsleutels voor Torx® schroeven

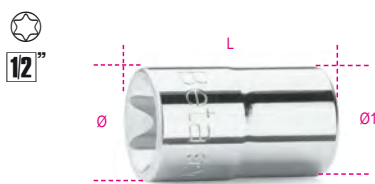

Ø mm	L mm	Ø1 mm	€		
E10	13,2	36	21	11,40	5 009200380
E12	15,0	37	21	11,40	5 009200381
E14	16,3	37	21	11,40	5 009200382
E16	18,8	37	22	11,40	5 009200383
E18	20,4	37	22	11,40	5 009200384
E20	22,9	37	22	12,70	5 009200385
E22	25,0	37	24	14,60	3 009200387
E24	26,5	40	25	16,90	3 009200388



920FTX/SB6 € 82,50 1 009200390
 E10-E12-E14
 E16-E18-E20



920FTX/C8 € 139,00 1 009200391
 E10-E12-E14-E16
 E18-E20-E22-E24

≡ 270X120X45 mm - 1 kg

920FTX/L

Dopsleutels voor Torx® schroeven, lange uitvoering



Ø mm	L mm	Ø1 mm	€		
E10	13,2	77	21,0	24,80	5 009200400
E12	15,0	77	21,0	24,80	5 009200401
E14	16,3	77	21,0	24,80	5 009200402
E16	18,8	77	21,8	24,80	3 009200403
E18	20,4	77	21,8	24,80	3 009200404
E20	22,9	77	22,0	24,80	3 009200405



920FTX-LSB6 € 161,50 1 009200409
 E10-E12-E14
 E16-E18-E20

920LP

Schroevendraaier-doppen voor sleufschroeven



SxA mm	Ø mm	L mm	L1 mm	€		
1x5,5	22,5	62	24	19,50	3	009200452
1,2x6,5	22,5	62	24	19,50	3	009200453
1,2x8	22,5	62	24	19,50	3	009200454
1,6x9	22,5	62	24	19,50	3	009200456
2x12	22,5	62	24	19,50	3	009200458

920PH

Schroevendraaierdoppen voor Phillips® kruiskopschroeven



PH	Ø mm	L mm	L1 mm	€		
1	22,5	56	18	17,30	3	009200471
2	22,5	56	18	17,30	3	009200472
3	22,5	56	18	17,30	3	009200473
4	22,5	56	18	17,30	3	009200474



920PH/SB4 € 79,00 1 009200479
 PH1-PH2-PH3-PH4

920LH/SB7

Schroevendraaierdoppen voor sleuf en voor Phillips® kruiskopschroeven



	€		
920LH/SB7	144,00	1	009200478
920LP	1,2x6,5 - 1,2x8		
	1,6x9 - 2x12 mm		
920PH	PH2 - PH3 - PH4		

920PE

Schroevendraaierdoppen voor binnenzeskant schroeven

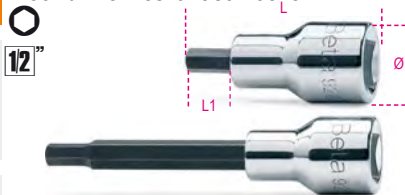

DIN 7422

mm	Ø mm	L mm	L1 mm	€	5	10
3	22,5	58	20	15,70	5	009200410
4	22,5	58	20	15,70	5	009200412
5	22,5	58	20	15,70	5	009200414
5L	22,5	100	62	17,50	5	009200415
6	22,5	58	20	15,70	5	009200417
6L	22,5	100	62	17,50	5	009200418
7	22,5	58	20	15,70	5	009200420
7L	22,5	100	62	17,50	5	009200421
8	22,5	58	20	15,70	5	009200423
8L	22,5	100	62	17,50	5	009200424
9	22,5	58	20	15,70	5	009200425
9L	22,5	140	102	17,60	5	009200426
10	22,5	58	20	15,70	5	009200428
10L	22,5	140	102	17,60	5	009200429
12	23,0	58	20	18,30	5	009200432
12L	22,5	140	102	20,80	5	009200433
14	23,0	58	20	18,30	5	009200434
14L	22,5	140	102	20,80	5	009200435
17	29,5	60	22	22,20	5	009200437
19	29,5	60	22	22,20	5	009200439



920PE/SB9
4-5-6-8-10 mm
5L-6L-8L-10L mm
€ 165,00 1 009200441



920PE/C10
4-5-6-7-8-10
12-14-17-19 mm
€ 213,00 1 009200443
270X120X45 mm - 1,5 kg

9899 920PE/C10
Thermogevormde inlay, leeg
€ 15,00 1 098990135

920PE/AS

Schroevendraaierdoppen voor binnenzeskant schroeven



"	Ø mm	L mm	L1 mm	€	2	10
1/8	22,5	58	20	18,30	2	009200460
3/16	22,5	58	20	18,30	2	009200461
1/4	22,5	58	20	18,30	2	009200463
3/8	22,5	58	20	18,30	2	009200464
1/2	22,5	60	20	19,70	2	009200465
3/4	22,5	60	20	21,00	1	009200468

12"



920PE-AS/SB6
1/8-3/16-1/4-3/8-1/2-3/4
€ 126,50 1 009200469

920BP

Dopsleutels met kogelkop aansluiting voor inbuschroeven

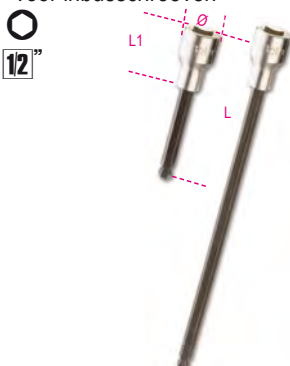

mm	Ø mm	L mm	L1 mm	€	5	10
5L	22,5	100	62	18,70	5	009200490
5XL	22,5	240	202	24,90	1	009200495
6L	22,5	100	62	18,70	5	009200491
6XL	22,5	240	202	24,90	1	009200496
7L	22,5	100	62	18,70	5	009200492
8L	22,5	100	62	18,70	5	009200493
8XL	22,5	240	202	24,90	1	009200497
10L	22,5	140	102	20,20	5	009200494

12"



920BP/SB8
5L-6L-7L-8L-10L mm
5XL-6XL-8XL mm
€ 185,50 1 009200500

920ME

Schroevendraaierdoppen voor binnenzeskant schroeven



mm	Ø mm	L mm	L1 mm	€	5	10
5	21	75	15,5	17,50	5	009200505
6	21	75	15,5	17,50	5	009200506
7	21	75	15,5	17,50	5	009200507
8	21	75	15,5	17,50	5	009200508
10	23	75	15,5	18,10	5	009200510
12	24	75	15,5	20,80	5	009200512
14	24	75	15,5	21,10	5	009200514
17	24	75	15,5	21,10	5	009200517

12"



920ME/SB7
5-6-8-10-12-14-17 mm
€ 147,50 1 009200519

12"



920ME/C7
5-6-8-10-12-14-17 mm
€ 170,50 1 009200518
250X100X35 mm - 1,4 kg

920TX

Schroevendraaierdoppen voor Torx® schroeven



mm	Ø mm	L mm	L1 mm	€	5	10
T20	22,5	58	20	19,20	5	009200520
T20L	22,5	120	82	24,60	3	009200530
T25	22,5	58	20	19,20	5	009200521
T25L	22,5	120	82	24,60	3	009200531
T27	22,5	58	20	19,20	5	009200522
T27L	22,5	120	82	24,60	3	009200533
T30	22,5	58	20	19,20	5	009200523
T30L	22,5	120	82	24,60	3	009200534
T40	22,5	58	20	19,20	5	009200524
T40L	22,5	120	82	24,60	3	009200535
T45	22,5	58	20	19,20	5	009200525
T45L	22,5	120	82	24,60	3	009200537
T50	22,5	58	20	19,40	5	009200526
T50L	23,0	140	102	24,60	3	009200538
T55	23,0	58	20	25,50	3	009200527
T55L	23,0	140	102	35,50	3	009200539
T60	23,0	58	20	25,50	3	009200528
T60L	23,0	140	102	35,50	3	009200540
T70L	23,0	120	82	35,50	3	009200541

12"



920TX/SB9
T20-T25-T27-T30
T40-T45-T50-T55-T60
€ 202,00 1 009200532



920TX-L/SB10
T20L-T25L-T27L-T30L-T40L-
T45L-T50L-T55L-T60L-T70L
€ 297,00 1 009200545

12"



920TX/C9
T20-T25-T27-T30-T40
T45-T50-T55-T60
€ 223,50 1 009200546
270X120X45 mm - 1,2 kg

9899 920TX/C9
Thermogevormde inlay, leeg
€ 15,00 1 098990136

920RTX

Dopsleutels voor Tamper Resistant Torx® schroeven



⊕	Ø mm	L mm	L1 mm	€	📦	📄
T20	22,5	58	20	20,50	5	009200370
T25	22,5	58	20	20,50	5	009200371
T27	22,5	58	20	20,50	5	009200372
T30	22,5	58	20	20,50	5	009200373
T40	22,5	58	20	20,50	5	009200374



920RTX/SB5
T20-T25-T27-T30-T40

€ 114,00 📦 1 📄 009200378

920XZN

Schroevendraaier-doppen met XZN® profiel

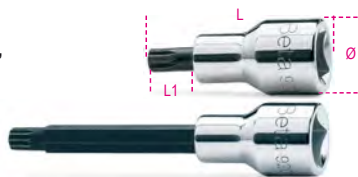

DIN 2324

○	Ø mm	L mm	L1 mm	€	📦	📄
M4	22,5	58	20	19,50	3	009200559
M5	22,5	58	20	19,50	3	009200560
M6	22,5	58	20	19,50	3	009200561
M6L	22,5	100	62	22,30	3	009200562
M8	22,5	58	20	19,50	3	009200563
M8L	22,5	100	62	22,30	3	009200564
M9	22,5	58	20	19,50	3	009200582
M9L	22,5	100	62	22,30	3	009200583
M10	22,5	58	20	19,60	3	009200565
M10L	22,5	100	62	22,30	3	009200566
M12	22,5	58	20	21,30	3	009200568
M12L	22,5	100	62	23,60	3	009200569
M14	23,0	58	20	21,30	3	009200571
M14L	23,0	100	62	23,60	3	009200572
M16	23,0	58	20	25,00	3	009200573
M18	23,0	58	20	26,00	3	009200574



920XZN/SB7
M4-M5-M6-M8
M10-M12-M14

€ 154,00 📦 1 📄 009200579



920XZN/SB12
M5-M6-M8-M10-M12
M14-M16-M6L-M8L
M10L-M12L-M14L

€ 281,00 📦 1 📄 009200577



920XZN-L/S5
M6L-M8L-M10L
M12L-M14L

€ 114,00 📦 1 📄 009200578

920ES

Dopsleutel met speciaal profiel



UNI 9326

Ø mm	⊕	L mm	L1 mm	€	📦	📄
7	(6R)	58	20	27,00	5	009200587
7XL	(6R)	240	202	39,50	1	009200607
9	(8R)	58	20	27,00	5	009200589
9XL	(8R)	240	202	39,50	1	009200609
10	(8S)	58	20	27,00	5	009200590
10XL	(8S)	240	202	39,50	1	009200610
11	(10R)	58	20	27,00	5	009200591
11XL	(10R)	240	202	39,50	1	009200611
12L	(10S)	100	62	31,50	3	009200592
12XL	(10S)	240	202	43,50	1	009200612
14L	(12S)	100	62	31,50	3	009200594
14XL	(12S)	240	202	43,50	1	009200614
16L	(14R)	100	62	31,50	3	009200596
16XL	(14R)	240	202	43,50	1	009200616



920ES/SB7
7-9-10-11-12L-14L-16L

€ 216,50 📦 1 📄 009200598



920ES-XL/SB7
7XL-9XL-10XL-11XL
12XL-14XL-16XL

€ 302,00 📦 1 📄 009200618

PM 1/2-Q5



PM 1/2-Q5

€ 72,560

920/15

Verlooppop 1/2" naar 3/8"



UNI/ISO 3316 DIN 3123

L mm	□	■	Ø mm	€	📦	📄
42	1/2	3/8	22,0	12,20	5	009200810



Altijd het toegestane koppel volgen en gelijkmatig en progressief aantrekken om het breken en eventuele verwondingen te voorkomen.

920/16

Verlooppop 1/2" naar 3/4"



UNI/ISO 3316 DIN 3123

L mm	□	■	Ø mm	€	📦	📄
46	1/2	3/4	26	15,70	5	009200814

920/20+920/23

1/2" verlengstukken



UNI/ISO 3316 DIN 3123

	L mm	Ø mm	€	📦	📄
920/20	75	22	15,00	5	009200818
920/21	125	22	17,40	5	009200822
920/22	255	22	19,80	5	009200826
920/23	375	22	26,00	2	009200827

920AN

1/2" verlengstukken, zwenkbaar

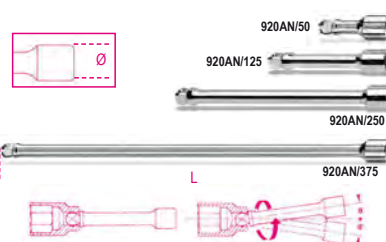

	L mm	Ø mm	€	📦	📄
920AN/50	50	22	15,80	5	009200833
920AN/125	125	22	23,50	5	009200834
920AN/250	250	22	32,00	3	009200835
920AN/375	375	22	42,00	3	009200836

920/25

1/2" cardangewricht



UNI/ISO 3316 DIN 3123

L	Ø	€	5	009200830
mm	mm			
75	27	29,00		

920/35A

1/2" handgreep met kniegewricht



UNI/ISO 3315 DIN 3122

L	L1	€	3	009200846
mm	mm			
285	160	54,50		

920M/35

1/2" wringijzer met kniegewricht



UNI/ISO 3315 DIN 3122

L	€	2	009200845
mm			
380	79,00		

920M/35L

1/2" wringijzer met kniegewricht, lange uitvoering



L	€	1	009200843
mm			
600	119,50		



Altijd het toegestane koppel volgen en gelijkmatig en progressief aantrekken om het breken en eventuele verwondingen te voorkomen.

920/36A

1/2" handgreep met kniegewricht



UNI/ISO 3315 DIN 3122

L	L1	€	2	009200847
mm	mm			
408	283	63,50		

920/38

1/2" uitschuifbare handgreep met kniegewricht



L	L max	€	1	009200839
mm	mm			
262	402	96,50		

920/40

1/2" T-sleutel met cardangewricht

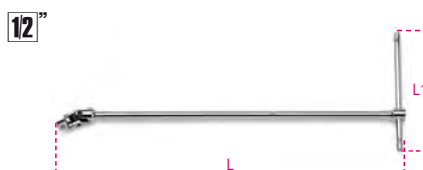

L	L1	€	2	009200850
mm	mm			
490	230	67,00		

920/42

1/2" wringstaaf

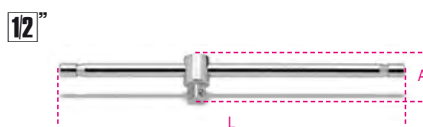

L	A	€	5	009200854
mm	mm			
305	42	20,10		

920/44

1/2" gebogen wringstaaf



L	L1	€	3	009200858
mm	mm			
230	60	30,00		

920/46

1/2" omslag met handgreep

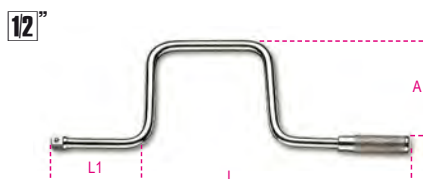

L	L1	A	€	1	009200862
mm	mm	mm			
385	110	160	35,50		

920/50

1/2" ratel met doorsteekvierkant, 72 tands



UNI/ISO 3315 DIN 3122

L	Ø	A	€	3	009200871
mm	mm	mm			
275	40	42	61,00		

920/50F

1/2" ratel met open vierkant, 72 tands



UNI/ISO 3315 DIN 3122

L	Ø	A	€	2	009200889
mm	mm	mm			
275	40	27	58,00		

920/55

1/2" omschakelbare ratel, 72 tands



UNI/ISO 3315 DIN 3122

L	Ø	A	€	3	009200882
mm	mm	mm			
275	40	43	64,00		

920/55Q

1/2" omschakelbare ratel, 48 tands



UNI/ISO 3315 DIN 3122

L	Ø	A	€	3	009200885
mm	mm	mm			
275	40	43	64,00		

920/55X

1/2" omschakelbare ratel, 72 tands

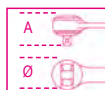

UNI/ISO 3315 DIN 3122

L	Ø	A	€		
mm	mm	mm			
200	30	33	56,00	3	009200895

920/55LC

1/2" omschakelbare ratel, blokkersysteem, 72 tands



UNI/ISO 3315 DIN 3122

L	Ø	A	€		
mm	mm	mm			
275	40	43	76,00	2	009200896

920M/55

1/2" omschakelbare ratel met metalen handgreep



L	Ø	A	€		
mm	mm	mm			
253	38	35	87,50	1	009200893

920/56A

1/2" omschakelbare ratel met kniegewricht, 72 tands

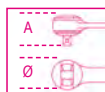

L	Ø	A	€		
mm	mm	mm			
315	40	43	108,00	1	009200911

920M/56

1/2" omschakelbare ratel met metalen handgreep en kniegewricht



L	Ø	A	€		
mm	mm	mm			
330	38	35,7	116,00	2	009200894

920/58

1/2" omschakelbare ratel met draaibare handgreep, 52 tands ratelmechanisme

- Werking door het draaien van de handgreep
- Dop vergrendelingsknop
- Omschakelen door ring op de ratelkop
- Twee componenten handgreep

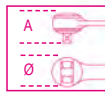

L	Ø	A	€		
mm	mm	mm			
281	42,5	45	100,00	1	009200926

Zie de tabel na item 929/C8 voor de draaiende onderdelen van het ratelmechanisme



920.../C11

Doppendoos met 11 dopsleutels en 2 toebehoren

12"



920A/C11	€		
	210,00	1	009200921

	920A	10 - 12 - 13 - 14 - 15 - 16 17 - 18 - 19 - 21 - 22 mm
	920/22	255 mm
	920/50	
≡ 335x145x60 mm - 2,5 kg		

920B/C11	€		
	210,00	1	009200922

	920B	10 - 12 - 13 - 14 - 15 - 16 17 - 18 - 19 - 21 - 22 mm
	920/22	255 mm
	920/50	
≡ 335x145x60 mm - 2,5 kg		

920.../C12...

Doppendoos met 12 dopsleutels en 5 toebehoren

12"



920A/C12X	€		
	308,00	1	009200933

	920A	10 - 11 - 12 - 13 - 14 - 17 - 19 22 - 24 - 27 - 30 - 32 mm
	920/21	125 mm
	920/22	255 mm
	920/25	
	920/42	
	920/55	
≡ 420x185x60 mm - 4,2 kg		

9899 920C12	€		
	15,50	1	098990116

Thermogevormde inlay, leeg

920A/C12	€		
	305,00	1	009200931

	920A	10 - 11 - 12 - 13 - 14 - 17 - 19 22 - 24 - 27 - 30 - 32 mm
	920/21	125 mm
	920/22	255 mm
	920/25	
	920/42	
	920/50	
≡ 420x185x60 mm - 4,2 kg		

9899 920C12 € 15,50 1 098990116
Thermogevormde inlay, leeg

920B/C12X € 308,00 1 009200934

- 920B 10 - 11 - 12 - 13 - 14 - 17 - 19
22 - 24 - 27 - 30 - 32 mm
- 920/21 125 mm
- 920/22 255 mm
- 920/25
- 920/42
- 920/55

420x185x60 mm - 4,0 kg

9899 920C12 € 15,50 1 098990116
Thermogevormde inlay, leeg

920B/C12 € 305,00 1 009200932

- 920B 10 - 11 - 12 - 13 - 14 - 17 - 19
22 - 24 - 27 - 30 - 32 mm
- 920/21 125 mm
- 920/22 255 mm
- 920/25
- 920/42
- 920/50

420x185x60 mm - 4,0 kg

9899 920C12 € 15,50 1 098990116
Thermogevormde inlay, leeg

920MC/C14

14 gekleurde zeskant dopsleutels
en 5 toebehoren

12^{''}



920MC/C14 € 325,00 1 009202964

- 920MC 8 - 10 - 11 - 12 - 13 - 14 - 15 - 16 - 17
- 18 - 19 - 21 - 22 - 24 mm
- 920/21 125 mm
- 920/22 255 mm
- 920/25
- 920/42
- 920/55

420x185x60 mm - 4,2 kg

920.../C20...

Doppendoos met 20 dopsleutels
en 5 toebehoren

12^{''}



920A/C20X € 379,00 1 009200950

- 920A 10 - 11 - 12 - 13 - 14 - 15 - 16
17 - 18 - 19 - 20 - 21 - 22 - 23
24 - 26 - 27 - 28 - 30 - 32 mm
- 920/21 125 mm
- 920/22 255 mm
- 920/25
- 920/42
- 920/55

420x185x60 mm - 5,1 kg

9899 920C20 € 15,50 1 098990121
Thermogevormde inlay, leeg

920A/C20 € 376,00 1 009200948

- 920A 10 - 11 - 12 - 13 - 14 - 15 - 16
17 - 18 - 19 - 20 - 21 - 22 - 23
24 - 26 - 27 - 28 - 30 - 32 mm
- 920/21 125 mm
- 920/22 255 mm
- 920/25
- 920/42
- 920/50

420x185x60 mm - 5,1 kg

9899 920C20 € 15,50 1 098990121
Thermogevormde inlay, leeg

920A/C20Q € 379,00 1 009200955

- 920A 10 - 11 - 12 - 13 - 14 - 15 - 16
17 - 18 - 19 - 20 - 21 - 22 - 23
24 - 26 - 27 - 28 - 30 - 32 mm
- 920/21 125 mm
- 920/22 255 mm
- 920/25
- 920/42
- 920/55Q

420x185x60 mm - 5,1 kg

9899 920C20 € 15,50 1 098990121
Thermogevormde inlay, leeg

920B/C20 € 376,00 1 009200949

- 920B 10 - 11 - 12 - 13 - 14 - 15 - 16
17 - 18 - 19 - 20 - 21 - 22 - 23
24 - 26 - 27 - 28 - 30 - 32 mm
- 920/21 125 mm
- 920/22 255 mm
- 920/25
- 920/42
- 920/50

420x185x60 mm - 5,0 kg

9899 920C20 € 15,50 1 098990121
Thermogevormde inlay, leeg

920B/C20X € 379,00 1 009200951

- 920B 10 - 11 - 12 - 13 - 14 - 15 - 16
17 - 18 - 19 - 20 - 21 - 22 - 23
24 - 26 - 27 - 28 - 30 - 32 mm
- 920/21 125 mm
- 920/22 255 mm
- 920/25
- 920/42
- 920/55

420x185x60 mm - 5,0 kg

9899 920C20 € 15,50 1 098990121
Thermogevormde inlay, leeg

920.../C21...

Doppendoos met 21 dopsleutels
en 6 toebehoren

12^{''}



920A/C21 € 436,00 1 009200952

- 920A 10 - 11 - 12 - 13 - 14 - 15 - 16
17 - 18 - 19 - 20 - 21 - 22 - 23
24 - 25 - 26 - 27 - 28 - 30 - 32 mm
- 920/21 125 mm
- 920/22 255 mm
- 920/25
- 920/42
- 920/46
- 920/50

420x280x60 mm - 6,5 kg

920A/C21X € 439,00 1 009200983

- 920A 10 - 11 - 12 - 13 - 14 - 15 - 16
17 - 18 - 19 - 20 - 21 - 22 - 23
24 - 25 - 26 - 27 - 28 - 30 - 32 mm
- 920/21 125 mm
- 920/22 255 mm
- 920/25
- 920/42
- 920/46
- 920/55

420x280x60 mm - 6,4 kg







920B/C21 € 436,00 1 009200953

- 920B 10 - 11 - 12 - 13 - 14 - 15 - 16
17 - 18 - 19 - 20 - 21 - 22 - 23
24 - 25 - 26 - 27 - 28 - 30 - 32 mm
- 920/21 125 mm
- 920/22 255 mm
- 920/25
- 920/42
- 920/46
- 920/50

420x280x60 mm - 6,4 kg

Beta

920B/C21X € 439,00 1 009200984

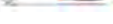
-  ○ 920B 10 - 11 - 12 - 13 - 14 - 15 - 16
17 - 18 - 19 - 20 - 21 - 22 - 23
24 - 25 - 26 - 27 - 28 - 30 - 32 mm
 -  920/21 125 mm
 -  920/22 255 mm
 -  920/25
 -  920/42
 -  920/46
 -  920/55
- 420x280x60 mm - 6,4 kg







920B/C30Q

Doppendoos met 30 twaalfkant dopsleutels en 5 toebehoren

12"



920B/C30Q € 610,00 1 009200975

-  ○ 920B 8 - 9 - 10 - 11 - 12 - 13 - 14
15 - 16 - 17 - 18 - 19 - 20 - 21
22 - 23 - 24 - 26 - 27 - 30 mm
 -  ○ 920BL 12 - 13 - 14 - 17 - 19 - 21
22 - 24 - 27 - 30 mm
 -  920/21 125 mm
 -  920/22 255 mm
 -  920/25
 -  920/42
 -  920/55Q
- 420x280x60 mm - 7,6 kg

Beta









920.../C33

Doppendoos met 20 dopsleutels, 13 schroevendraaierdoppen en 5 toebehoren



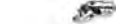



12"



920A/C33 € 619,00 1 009200985

-  ○ 920A 10 - 11 - 12 - 13 - 14 - 15 - 16
17 - 18 - 19 - 20 - 21 - 22 - 23
24 - 26 - 27 - 28 - 30 - 32 mm
 -  ● 920LP 1,2x8 - 1,6x9 - 2x12 mm
 -  ⊕ 920PH PH2 - PH3 - PH4
 -  ○ 920PE 4 - 5 - 6 - 8 - 10 - 12 - 14 mm
 -  920/21 125 mm
 -  920/22 255 mm
 -  920/25
 -  920/42
 -  920/55
- 420x280x60 mm - 6,7 kg

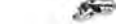
920B/C33 € 619,00 1 009200986

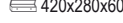
-  ○ 920B 10 - 11 - 12 - 13 - 14 - 15 - 16
17 - 18 - 19 - 20 - 21 - 22 - 23
24 - 26 - 27 - 28 - 30 - 32 mm
 -  ● 920LP 1,2x8 - 1,6x9 - 2x12 mm
 -  ⊕ 920PH PH2 - PH3 - PH4
 -  ○ 920PE 4 - 5 - 6 - 8 - 10 - 12 - 14 mm
 -  920/21 125 mm
 -  920/22 255 mm
 -  920/25
 -  920/42
 -  920/55
- 420x280x60 mm - 6,7 kg







920A/C17M - 920A/C17MR

Assortiment van 17 zeskant 1/2" dopsleutels en 5 toebehoren in zachte foam inleg. in metalen kist

12"



920A/C17M € 349,00 1 009200924

-  ○ 920A 10-11-12-13-14-15-16-17-18
19-20-21-22-24-27-30-32 mm
 -  920/21 125 mm
 -  920/22 255 mm
 -  920/25
 -  920/42 305 mm
 -  920/55
- 420x185x60 mm - 5 kg

9899 920C17 € 27,50 1 098990137
Softmodule, leeg

920A/C17MR € 385,00 1 009200937

-  920/21 125 mm
 -  920/22 255 mm
 -  920/25
 -  920/42 305 mm
 -  920/58
- 420x185x60 mm 5,1 kg

920/C37

Doppendoos met 37 twaalfkant dopsleutels en 5 toebehoren

12"



920/C37 € 562,00 1 009200988

-  ○ 920B 10 - 11 - 12 - 13 - 14 - 15 - 16
17 - 18 - 19 - 20 - 21 - 22 - 23
24 - 26 - 27 - 28 - 30 - 32 mm
 -  ○ 920AS 3/8 - 7/16 - 1/2 - 9/16 - 19/32
5/8 - 11/16 - 3/4 - 25/32 - 13/16
7/8 - 15/16 - 1 - 1.1/16 - 1.1/8
1.3/16 - 1.1/4
 -  920/21 125 mm
 -  920/22 255 mm
 -  920/25
 -  920/42
 -  920/55
- 420x280x60 mm - 7,5 kg

Beta

920AS/C10

Doppendoos met 10 twaalfkant dopsleutels en 2 toebehoren

12"



920AS/C10 € 214,50 1 009200919

○ 920AS 3/8 - 7/16 - 1/2 - 9/16 - 5/8
11/16 - 3/4 - 13/16 - 7/8 - 15/16

920/22 255 mm

920/50

335x145x60 mm - 2,6 kg

920AS/C15

Doppendoos met 15 twaalfkant dopsleutels en 6 toebehoren

12"



920AS/C15 € 405,00 1 009200947

○ 920AS 3/8 - 7/16 - 1/2 - 9/16 - 5/8 - 11/16
3/4 - 13/16 - 7/8 - 15/16 - 1
1.1/16 - 1.1/8 - 1.3/16 - 1.1/4

920/21 125 mm

920/22 255 mm

920/25

920/42

920/46

920/50

420x280x60 mm - 5,9 kg

Beta

920AS/C17X

Doppendoos met 17 twaalfkant dopsleutels en 5 toebehoren

12"



920AS/C17X € 376,00 1 009200942

○ 920AS 3/8 - 7/16 - 1/2 - 9/16 - 19/32 - 5/8
11/16 - 3/4 - 25/32 - 13/16 - 7/8
15/16 - 1 - 1.1/16 - 1.1/8 - 1.3/16 - 1.1/4

920/21 125 mm

920/22 255 mm

920/25

920/42

920/55

420x185x60 mm - 4,8 kg

920AS/MBM-C21

Doppendoos met 16 twaalfkant dopsleutels en 5 toebehoren

12"



920AS/MBM-C21 € 388,00 1 009200944

○ 920AS 3/8 - 7/16 - 1/2 - 9/16
19/32 - 5/8 - 11/16 - 3/4
25/32 - 13/16 - 7/8 - 15/16
1 - 1.1/16 - 1.3/16 - 1.1/4

920M/55

920/21 125 mm

920/22 255 mm

920/25

920/42

420x185x60 mm - 5,0 kg

920TX/C17

6 bits, 6 dopsleutels,
5 schroevendraaierdoppen,
en 4 toebehoren voor Torx® schroeven

12"

12"

12"



920TX/C17 € 365,00 1 009200989

861TX T8 - T10 - T15 - T20 - T25 - T27

897

920TX T27 - T30 - T40 - T45 - T50

920FTX E10 - E12 - E14 - E16 - E18 - E20

920/20 75 mm

920/22 255 mm

920/55

420x185x60 mm - 2,9 kg

920A/C17HR

17 zeskant dopsleutels en 5 toebehoren
in harde foam inleg, in metalen kist

• Ratel met draaibare handgreep

12"



920A/C17HR € 385,00 1 009200939

○ 920A 10-11-12-13-14-15-16-17-18
19-20-21-22-24-27-30-32 mm

920/21 125 mm

920/22 255 mm

920/25

920/42

920/58

420x185x60 mm - 5,1 kg

Beta

920U/C17M

Dopendoos met 17 gearlock dop sleutels en 5 toebehoren, in zachte foam inleg

12"



920U/C17M € 357,00 1 009201797

920U ○ 10-11-12-13-14-15-16-17-18-19-20
21-22-24-27-30-32 mm
" 3/8-7/16-15/32-1/2-9/16-19/32-5/8-3/4
25/32-7/8-15/16-1.1/16-1.1/8-1.1/4
○ M12-M14-M16-M18
○ E12-E14-E16-E18-E20-E22-E24

920/21 125 mm
920/22 255 mm
920/25
920/42 305 mm
920/55 275 mm

420x185x60 mm - 5 kg

9899 920C17 € 27,50 1 098990137
Softmodule, leeg

928A

Dopsleutels zeskant



UNI/ISO 2725
DIN 3124

Ø mm	Ø mm	L mm	Ø1 mm	€	5	10
19	29,2	50	34	18,70	5	009280019
21	30,0	51	34	19,10	5	009280021
22	31,3	53	34	19,10	5	009280022
23	33,3	53	34	19,20	5	009280023
24	34,5	53	34	19,40	5	009280024
26	36,8	55	35	21,20	5	009280026
27	38,0	56	35	21,20	5	009280027
28	39,0	57	35	21,90	3	009280028
29	40,2	58	35	22,20	3	009280029
30	41,5	58	37	23,00	3	009280030
32	44,3	60	37	23,90	3	009280032
33	45,8	60	37	25,50	3	009280033
34	46,8	60	37	25,50	3	009280034
35	48,1	62	38	27,00	3	009280035
36	49,5	64	38	27,00	3	009280036
38	52,0	68	40	29,00	3	009280038
41	56,0	71	40	32,50	3	009280041
46	62,3	75	43	39,00	3	009280046
50	67,4	80	43	47,00	3	009280050
55	73,7	84	48	57,50	1	009280055
60	80,0	87	48	66,00	1	009280060

928B

Dopsleutels twaalfkant



UNI/ISO 2725
DIN 3124

Ø mm	Ø mm	L mm	Ø1 mm	€	5	10
19	29,2	50	34	18,70	5	009280119
21	30,0	51	34	19,10	5	009280121
22	31,3	53	34	19,10	5	009280122
23	33,3	53	34	19,20	5	009280123
24	34,5	53	34	19,40	5	009280124
26	36,8	55	35	21,20	5	009280126
27	38,0	56	35	21,20	5	009280127
28	39,0	57	35	21,90	3	009280128
29	40,2	58	35	22,20	3	009280129
30	41,5	58	37	23,00	3	009280130
32	44,3	60	37	23,90	3	009280132
33	45,8	60	37	25,50	3	009280133
34	46,8	60	37	25,50	3	009280134
35	48,1	62	38	27,00	3	009280135
36	49,5	64	38	27,00	3	009280136
38	52,0	68	40	29,00	3	009280138
41	56,0	71	40	32,50	3	009280141
46	62,3	75	43	39,00	3	009280146
50	67,4	80	43	47,00	3	009280150
55	73,7	84	48	57,50	1	009280155
60	80,0	87	48	66,00	1	009280160

928AS

Dopsleutels zeskant



Ø mm	Ø mm	L mm	Ø1 mm	€	5	10
7/8	32,0	53	34	20,80	1	009280202
15/16	34,5	53	34	20,80	1	009280203
1	36,2	55	35	22,80	1	009280204
1.1/16	38,0	56	35	23,50	1	009280205
1.1/8	40,2	58	35	24,00	1	009280206
1.1/4	44,2	60	37	25,00	1	009280208
1.5/16	45,8	60	37	26,50	1	009280209
1.3/8	48,1	62	38	29,00	1	009280210
1.7/16	49,5	64	38	30,00	1	009280211
1.1/2	52,0	68	40	33,00	1	009280212
1.5/8	56,0	71	40	34,50	1	009280214
1.11/16	58,8	74	40	40,50	1	009280215
1.13/16	62,3	75	43	45,00	1	009280217
1.7/8	65,0	78	43	49,00	1	009280218
2	68,3	80	43	54,00	1	009280219
2.1/16	71,5	83	48	62,50	1	009280220

928ME

Schroevendraaierdoppen voor binnenzeskant schroeven



mm	Ø mm	L mm	L1 mm	€	5	10
14	35	75	15,5	43,50	2	009280514
17	35	75	15,5	43,50	2	009280517
19	35	75	15,5	43,50	2	009280519
22	35	75	22,5	44,50	2	009280522

928/15

Verlooppop 3/4" naar 1/2"



UNI/ISO 3316
DIN 3123

L mm Ø mm 3/4 1/2 € 23,40 5 009280801



Altijd het toegestane koppel volgen en gelijkmatig en progressief aantrekken om het breken en eventuele verwondingen te voorkomen.

928/16

Verlooppop 3/4" naar 1"



UNI/ISO 3316
DIN 3123

L mm Ø mm 3/4 1" € 26,50 5 009280807

928/20 - 928/21 - 928/22

3/4" verlengstukken

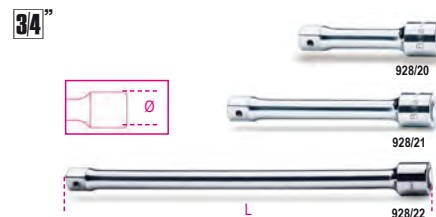

UNI/ISO 3316
DIN 3123

928/20	L mm	Ø mm	€	5	10
928/20	100	34	26,50	3	009280810
928/21	200	34	36,00	3	009280815
928/22	380	34	53,50	3	009280825

928/25

3/4" cardangewricht



UNI/ISO 3316 DIN 3123

L mm Ø mm € 83,50 1 009280830

928/36A

3/4" handgreep met kniegewricht



DIN 3122 - UNI ISO 3315

L
mm
545 € 105,50 1 009280844

928/42

3/4" wringstaaf

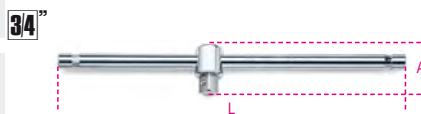

UNI/ISO 3315 DIN 3122

L mm 450 A mm 62,5 € 57,00 3 009280850

928/55

3/4" omschakelbare ratel, 72 tands



DIN 3122 - UNI ISO 3315

L mm 510 Ø mm 58 A mm 59 € 186,00 2 009280862

Zie de tabel na item 929/C8 voor de draaiende onderdelen van het ratelmechanisme

928.../C12

12 zeskant dopsleutels en 5 toebehoren in plaatstalen kist



928A/C12 € 950,00 1 009280955

928A	22 - 24 - 27 - 30 - 32 - 34 - 36 38 - 41 - 46 - 50 - 55 mm
928/21	200 mm
928/22	380 mm
928/25	
928/42	
928/55	

530x220x80 mm - 13,5 kg

928B/C12 € 950,00 1 009280957

928B	22 - 24 - 27 - 30 - 32 - 34 - 36 38 - 41 - 46 - 50 - 55 mm
928/21	200 mm
928/22	380 mm
928/25	
928/42	
928/55	

530x220x80 mm - 13,5 kg

928AS/C12

12 twaalfkant dopsleutels en 5 toebehoren in plaatstalen kist



928AS/C12 € 987,00 1 009280968

928AS	7/8-15/16-1.1/16-1.1/8-1.1/4 1.5/16-1.7/16-1.1/2-1.11/16 1.13/16-1.7/8-2.1/16
928/21	200 mm
928/22	380 mm
928/25	
928/42	
928/55	

530x220x80 mm - 13,5 kg

929

Dopsleutels zeskant



UNI/ISO 2725 DIN 3124

Ø mm	L mm	Ø1 mm	€	1	009290036
36	51	65	36,50	1	009290036
41	57	70	39,00	1	009290041
46	65	75	43,50	1	009290046
50	70	80	51,00	1	009290050
55	76	85	62,50	1	009290055
60	82	90	66,00	1	009290060
65	88	95	89,00	1	009290065
70	92	100	102,50	1	009290070
75	99	110	112,50	1	009290075
80	106	120	127,50	1	009290080

929/15

Verlooppop 1" naar 3/4"

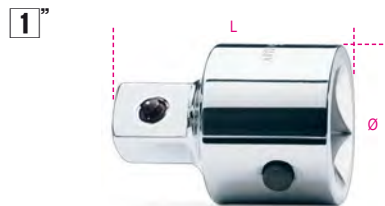

UNI/ISO 3316 DIN 3123

L mm 65 Ø mm 47 1" 3/4 € 45,00 2 009290801



Altijd het toegestane koppel volgen en gelijkmatig en progressief aantrekken om het breken en eventuele verwondingen te voorkomen.

929/21 - 929/22

1" verlengstukken



UNI/ISO 3316 DIN 3123

L mm 200 Ø mm 47 € 61,50 1 009290815
L mm 400 Ø mm 47 € 94,00 1 009290825

929/42

1" wringstaaf



UNI/ISO 3315 DIN 3122

L mm 535 € 118,00 1 009290850

929/55

1" omschakelbare ratel, 72 tands



UNI/ISO 3315 DIN 3122

L mm 770 Ø mm 62 A mm 63 € 245,00 1 009290860

929/55PR

verlengstuk voor ratels 929/55



L mm	Ø mm	Ø1 mm	€	1	009290868
540	32	26	52,00	1	009290868

929/C8

Doppendoos met 8 zeskant dopsleutels en 5 toebehoren

1"



929/C8	€	1	009290925
	1.405,00	1	009290925

	929	46 - 50 - 55 - 60 - 65 70 - 75 - 80 mm
	929/15	□ 1" - ■ 3/4
	929/21	200 mm
	929/22	400 mm
	929/42	
	929/55	

560x290x120 mm - 29 kg

9899 CV/A

Koffer, leeg



9899 CV/A	€	1	098990001
	38,00	1	098990001

583/C31-671B/C5-671B/C10-720ME/C8
860/C38P-861/C61P-900/C11-900AS/C10-/MB-C17
900/C24-900/C13-8-900/C13-5-900MB/C19-900MB/C28
900/C11HR-900AS/C10-/MB-C17-900AS/C17-MBM
900/C11Z-900MC/C24-900MC/C32-910.../C10
971/C8-920TX/C-920PE/C-920FTX/C-910.../C10

270x120x45 mm

9899 CV/B

Koffer, leeg



9899 CV/B	€	1	098990002
	44,50	1	098990002

352C/U-720MC/C13-727/C16-867/C20-900/C12MR
900/C12MZ-900U/C12M-910AS/C13...-910AS/MBM-C18
910A/C16...-910B/C16...-910A/C16HR
910A/C16...-910B/C16...-920AS/C10-920.../C11-1433/C11
1494/C14A-1529-1545/C5M

335x145x60 mm

9899 CV/C

Koffer, leeg



9899 CV/C	€	1	098990003
	57,00	1	098990003

920A/C17HR-920A/C17MR-920.../C12...
920A/C17M-910.../C29-902A/C22-867/C38
720/C24-450/C15-353N/C6-960KPC-920MC/C14
920U/C17M-920TX/C17-920.../C20...
920AS/MBM-C21-920AS/C17X-1547/C6-1495/C6
1489/C14-1461/C11A-1608/C9-1606A/C9-1602/C9

420x185x60 mm

900/R55

14"



900/R55	€	1	009000871
	40,00	1	009000871

666N/2-900/55-666/2-666LBF.FT/2

900/R55-Z

14"



900/R55-Z	€	1	009000872
	40,00	1	009000872

900M/R55

14"



900M/R55	€	1	009000888
	21,20	1	009000888

900M/55

910/R55

38"



910/R55	€	1	009100879
	39,00	1	009100879

599DGT/6-606/6-606/10-612-665/6-665/10-665LB/6
665LB/10-666N/5-666N/10-666N LBF.IN/5-666N.LBF.IN/10
666/6-666/10-668RGC/6-668RGC/10-910/55-666/5
666HS/5-666HS/10-666 LBF.FT/5-666 LBF.FT/10

910M/R55

38"



910M/R55	€	1	009100888
	21,40	1	009100888

910M/55-910M/56

910/R55Q

38"



910/R55Q	€	1	009100877
	39,00	1	009100877

910/55Q

910/R55X

38"



910/R55X	€	1	009100897
	39,00	1	009100897

666N/2X-666/2X-666 LBF.FT/2X

920/R50

12"



920/R50	€	1	009200866
	36,50	1	009200866

614/50-667/20-667/30
667N/20-667N/30-920/50

920/R55

12"



920/R55	€	1	009200879
	46,00	1	009200879

606/20-606/30-666/20-666/30-920/55
920/56A- 599DGT/20-599DGT/30
599DGT-AN/20-665/20-665/30-665LB/20
665LB/30-666N/20-666N/30
666N LBF.IN/20-666N LBF.IN/30-668RGC/20
666 LBF.FT/20-666 LBF.FT/30

920M/R55

12"



920M/R55	€	1	009200888
	24,90	1	009200888

920M/55-920M/56

920/R55Q

12"



920/R55Q	€	1	009200877
	46,00	1	009200877

920/55Q

920/R55X

12"
7/32"



920/R55X € 38,00 1 009200878
606/10X-612X
666/10X-920/55X-599DGT/10X-599DGT-AN/10
665/10X-665LB/10X-666N10X-666N LBF.IN/10X
668RGC/10X-666 LBF.FT/10X
666HS/20LC-666HS/30LC

920/R55LC

12"
7/32"



920/R55LC € 49,00 1 009200887
920/55LC "Locking System"
666HS/20LC-666HS/30LC

928/R55

3/4"
7/32"



928/R55 € 80,50 1 009280859
928/55

928/R55X

3/4"
7/32"



928/R55X € 50,50 1 009280858
614X

929/R55

1"
7/32"



929/R55 € 96,50 1 009290859
929/55

930

Pijpsleutels, twaalfkant en zware uitvoering



UNI 6745

Ø mm	L mm	Ø mm	Ø1 mm	€	5	10
6x7	100	9,5	11,0	15,20	3	009300006
8x9	108	12,5	14,0	19,10	3	009300010
10x11	116	15,0	16,5	20,00	3	009300014
12x13	124	17,5	19,0	23,70	3	009300018
14x15	132	20,0	21,5	26,00	3	009300023
16x17	140	23,0	24,0	30,00	3	009300027

Ø mm	L mm	Ø mm	Ø1 mm	€	5	10
18x19	148	25,0	26,5	32,50	3	009300032
20x22	156	28,0	30,0	37,00	2	009300036
21x23	163	29,0	31,5	39,50	2	009300040
24x26	173	33,0	35,5	49,00	2	009300044
25x28	182	34,5	38,0	53,00	2	009300048
27x29	191	37,0	39,5	61,50	2	009300052
30x32	200	40,5	43,0	74,50	2	009300056



930/S8	€	5	10
6x7-8x9-10x11-12x13-14x15 16x17-18x19-20x22 mm	218,50	1	009300081
940/1 - /2			
930/S13	€	5	10
6x7-8x9-10x11-12x13-14x15-16x17 18x19-20x22-21x23-24x26 25x28-27x29-30x32 mm	511,00	1	009300083
940/1 - /2 - /3			



930/C13	€	5	10
6x7-8x9-10x11-12x13 14x15-16x17-18x19 20x22-21x23-24x26 25x28-27x29-30x32 mm	566,00	1	009300098
940/1 - /2 - /3			

932

Gebogen pijpsleutels, twaalfkant en zeskant hoogglanzend verchroomd

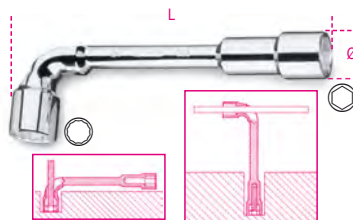

NF E 74.303

Ø mm	Ø mm	L mm	€	5	10
6x6	11,5	110	16,00	5	009320006
7x7	12,5	116	16,20	5	009320007
8x8	13,0	120	16,60	5	009320008
9x9	14,0	125	17,40	5	009320009
10x10	16,5	133	18,00	5	009320010
11x11	17,5	143	19,60	5	009320011
12x12	19,0	148	20,80	5	009320012
13x13	19,5	154	22,20	5	009320013
14x14	21,5	167	22,90	5	009320014
15x15	22,5	182	24,20	5	009320015
16x16	24,5	193	25,50	5	009320016
17x17	26,0	198	26,00	5	009320017
18x18	26,5	215	27,50	5	009320018
19x19	29,0	220	30,50	5	009320019
20x20	30,5	222	33,50	3	009320020
21x21	30,5	236	37,50	3	009320021
22x22	32,5	250	41,00	2	009320022
23x23	33,5	256	46,00	2	009320023
24x24	35,0	272	48,00	2	009320024
25x25	36,5	282	53,50	2	009320025

Ø mm	Ø mm	L mm	€	5	10
26x26	37,5	296	58,00	2	009320026
27x27	39,0	296	59,00	2	009320027
28x28	39,0	314	68,50	2	009320028
30x30	42,5	348	81,50	2	009320030
32x32	45,5	364	90,50	2	009320032



932/S11	€	5	10
6-7-8-10-11-12 13-14-17-19-22 mm	250,00	1	009320080
932/S17	€	5	10
6-7-8-9-10-11-12 13-14-15 16-17-18-19-20-21-22 mm	415,00	1	009320081
932/S25	€	5	10
6-7-8-9-10-11-12-13-14-15-16-17-18-19 20-21-22-23-24-25-26-27-28-30-32 mm	920,00	1	009320082

933

Gebogen pijpsleutels, zeskant hoogglanzend verchroomd

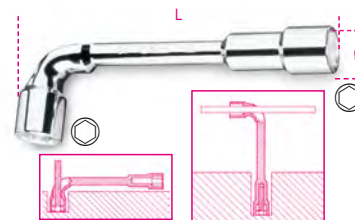

NF E 74.303

Ø mm	Ø mm	L mm	€	5	10
6x6	11,5	110	16,00	5	009330006
7x7	12,5	116	16,20	5	009330007
8x8	13,0	120	16,60	5	009330008
9x9	14,0	125	17,40	5	009330009
10x10	16,5	133	18,00	5	009330010
11x11	17,5	143	19,60	5	009330011
12x12	19,0	148	20,80	5	009330012
13x13	19,5	154	22,20	5	009330013
14x14	21,5	167	22,90	5	009330014
15x15	22,5	182	24,20	5	009330015
16x16	24,5	193	25,50	5	009330016
17x17	26,0	198	26,00	5	009330017
18x18	26,5	215	27,50	5	009330018
19x19	29,0	220	30,50	5	009330019
20x20	30,5	222	33,50	3	009330020
21x21	30,5	236	37,50	3	009330021
22x22	32,5	250	41,00	2	009330022
23x23	33,5	256	46,00	2	009330023
24x24	35,0	272	48,00	2	009330024
25x25	36,5	282	53,50	2	009330025
26x26	37,5	296	58,00	2	009330026
27x27	39,0	296	59,00	2	009330027
28x28	39,0	314	68,50	2	009330028
30x30	42,5	348	81,50	2	009330030
32x32	45,5	364	90,50	2	009330032



933/S11	€	5	10
6-7-8-10-11-12-13-14-17-19-22 mm	250,00	1	009330080
933/S17	€	5	10
6-7-8-9-10-11-12-13-14-15-16-17 18-19-20-21-22 mm	415,00	1	009330081
933/S25	€	5	10
6-7-8-9-10-11-12-13-14-15-16-17-18-19 20-21-22-23-24-25-26-27-28-30-32 mm	920,00	1	009330082

935

Pijpsleutels, zeskant en lichte uitvoering



UNI 6746 DIN 896

mm	L mm	€		
6x7	100	8,55	5	009350105
8x9	110	9,25	5	009350111
10x11	120	10,30	5	009350115
12x13	130	11,60	5	009350117
14x15	140	13,60	5	009350126
16x17	150	14,70	5	009350128
18x19	160	17,10	5	009350131
20x22	170	20,90	3	009350138
21x23	180	23,50	3	009350141
24x26	190	26,50	3	009350144
25x28	200	29,00	2	009350150
27x29	210	33,50	2	009350153
30x32	220	36,50	2	009350156



€		
121,00	1	009350181
285,00	1	009350183

937

Gebogen pijpsleutels, twaalfkant en zeskant verchromd

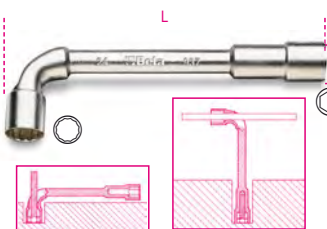

mm	Ø mm	L mm	€		
6x6	11,5	110	9,10	5	009370006
7x7	12,5	116	9,45	5	009370007
8x8	13,0	120	9,85	5	009370008
9x9	14,0	125	10,30	5	009370009
10x10	16,5	133	10,60	5	009370010
11x11	17,5	143	11,40	5	009370011
12x12	19,0	148	12,50	5	009370012
13x13	19,5	154	12,70	5	009370013
14x14	21,5	167	14,10	5	009370014
15x15	22,5	182	15,80	5	009370015
16x16	24,5	193	16,90	5	009370016
17x17	26,0	198	17,20	5	009370017
18x18	26,5	215	17,90	5	009370018
19x19	29,0	220	18,50	5	009370019
20x20	30,5	222	20,80	3	009370020
21x21	30,5	236	23,70	3	009370021
22x22	32,5	250	24,40	2	009370022
23x23	33,5	256	27,50	2	009370023
24x24	35,0	272	29,00	2	009370024
25x25	36,5	282	36,00	2	009370025
26x26	37,5	296	37,00	2	009370026
27x27	39,0	296	37,50	2	009370027
28x28	39,0	314	45,00	2	009370028
30x30	42,5	348	48,00	2	009370030
32x32	45,5	364	54,00	2	009370032



€		
150,00	1	009370080
255,00	1	009370081

940

Wringstaven voor modellen 930 en 935



mm	L mm	€		
6+13	100	6,30	5	009400001
14+22	170	8,60	5	009400002
21+32	290	15,40	5	009400003

941

T dopsleutels met zes en twaalfkant aansluiting, met krachthandgreep

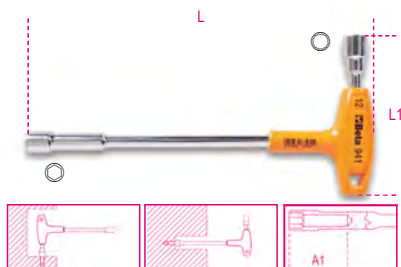

mm	L mm	L1 mm	A1 mm	€		
7x7	200	91	35	30,00	2	009410107
8x8	220	107	50	33,00	2	009410108
9x9	220	109	50	33,50	2	009410109
10x10	236	111	50	34,00	2	009410110
11x11	236	114	50	36,00	2	009410111
12x12	255	122	50	39,00	2	009410112
13x13	255	124	55	39,00	2	009410113



€		
244,50	1	009410170

DOPSCHROEVENDRAAIERS

Geschikt voor snelle, herhaalde draaibewegingen. De verminderde dikte van het dopgedeelte geeft toegang tot kleine ruimtes. Het inwendige zeskant maakt het gemakkelijker om moeren met uitstekende draadeinden te bewerken. Dit is met name het geval bij diepe model dopschroevendraaier 944BX.

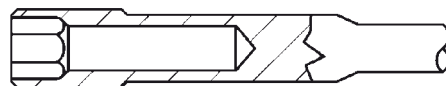

De drievoudige markering op het dopsleuteldeel maakt het gemakkelijker om de gewenste maat te identificeren. Het flexibele blad van model 943FL, dat bestaat uit een stalen kern beschermd door een huls, maakt koppeloverdracht mogelijk in geval van een verkeerde uitlijning met de schroef.

942BX

Dopschroevendraaiers, korte uitvoering



UNI 6750

mm	L mm	L1 mm	A1 mm	€		
4	190	70	13,0	16,00	5	009420003
5	190	70	14,0	16,00	5	009420004
5,5	190	70	12,5	18,40	5	009420005
6	190	70	14,5	18,40	5	009420006
7	190	70	15,5	19,30	5	009420007
8	202	70	18,5	19,30	5	009420008
9	202	70	19,5	19,30	5	009420009
10	202	70	20,5	20,00	3	009420010
11	202	70	21,5	20,00	3	009420011
12	202	70	22,5	20,00	3	009420012
13	202	70	23,5	22,60	3	009420013
14	202	70	24,5	22,60	3	009420014



€		
232,00	1	009420030

943BX

Dopschroevendraaiers, lange uitvoering



ISO 2236 UNI 6750

Ø mm	L mm	L1 mm	A1 mm	€	U	PC
4	270	150	13,0	17,80	5	009430003
5	270	150	14,0	17,80	5	009430004
5,5	270	150	12,5	19,60	5	009430005
6	270	150	14,5	19,60	5	009430006
7	270	150	15,5	20,80	5	009430007
8	282	150	18,5	20,80	5	009430008
9	282	150	19,5	20,80	5	009430009
10	282	150	20,5	21,90	3	009430010
11	282	150	21,5	21,90	3	009430011
12	282	150	22,5	21,90	3	009430012
13	282	150	23,5	23,10	3	009430013
14	282	150	24,5	23,10	3	009430014



943BX/S12 249,00 1 009430030
4-5-5,5-6-7-8-9
10-11-12-13-14 mm



943BX/D6 124,00 1 009430026
5-6-7-8-10-13 mm

943FL

Flexibele dopschroevendraaier



Ø mm	L mm	L1 mm	Ø mm	€	U	PC
5	265	150	8	24,80	2	009430304
5,5	265	150	8	24,90	2	009430305
6	265	150	9	24,90	2	009430306
7	265	150	11	24,90	2	009430307
8	265	150	12	25,50	2	009430308
10	290	175	14	27,00	2	009430310



943FL/S6 152,00 1 009430320
5-5,5-6-7-8-10 mm

944BX

Dopschroevendraaiers, diep model, lange uitvoering



ISO 2236 UNI 6750

Ø mm	L mm	L1 mm	A1 mm	€	U	PC
4	245	125	20	17,60	3	009440003
5	245	125	25	17,60	3	009440004
5,5	245	125	30	22,50	3	009440005
6	245	125	35	22,50	3	009440006
7	245	125	35	22,50	3	009440007
8	257	125	50	23,20	3	009440008
9	257	125	50	23,20	3	009440009
10	257	125	50	24,50	3	009440010
11	257	125	50	24,50	3	009440011
12	257	125	50	26,00	3	009440012
13	257	125	55	26,00	3	009440013
14	257	125	55	26,00	3	009440014



944BX/S12 276,00 1 009440062
4-5-5,5-6-7-8-9
10-11-12-13-14 mm



944BX/D6 136,50 1 009440056
5-6-7-8-10-13 mm

949

T greep diepe soksleutels

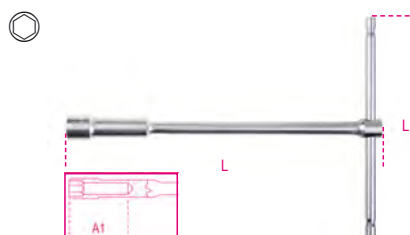

Ø mm	L mm	L1 mm	A1 mm	€	U	PC
8	220	160	50	32,50	2	009490008
10	230	160	50	33,00	2	009490010
12	240	175	50	34,50	2	009490012
13	244	175	55	36,50	2	009490013
14	250	190	55	38,00	2	009490014
17	264	200	60	43,50	2	009490017



949/S6 218,00 1 009490076
8-10-12-13-14-17mm

950

T-soksleutels

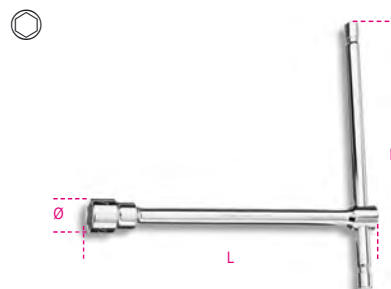

UNI 6742 DIN 3112

Ø mm	L mm	Ø mm	L1 mm	€	U	PC
6	210	10,1	145	22,70	3	009500006
7	212	11,2	145	22,70	3	009500007
8	220	12,4	160	24,40	3	009500008
9	223	13,5	160	24,40	3	009500009
10	230	14,9	160	25,50	3	009500010
11	233	16,1	160	25,50	3	009500011
12	240	17,5	175	28,00	3	009500012
13	244	19,7	175	28,00	3	009500013
14	250	20,1	190	32,00	3	009500014
15	254	21,5	190	33,50	3	009500015
16	260	22,7	200	37,00	3	009500016
17	264	24,1	200	37,50	3	009500017
19	274	26,6	230	47,00	3	009500019
22	290	29,9	290	59,00	2	009500022
24	300	32,2	320	67,50	2	009500024
27	315	36,2	370	79,50	2	009500027



950/S9 271,00 1 009500079
7-8-10-11-12
13-14-17-19 mm

950/S14 447,00 1 009500082
6-7-8-9-10-11-12-13
14-15-16-17-19-22 mm



951 T-SLEUTELS MET ZESKANT PROFIE OP DRIE ZIJDEN



Toen deze sleutel in 1980 werd gelanceerd, was het een revolutie. Ontworpen om te werken met schroeven met een hoge weerstand, het is de naam voor snelle hantering, nauwkeurige pasvorm en flexibel gebruik. De zeskant-T-handgreep kan naar wens worden aangepast. De zeskantige uiteinden zijn ontworpen om het maximaal mogelijke koppel op de schroef over te brengen. Door de lengte van de staaf kunnen opmerkelijke draaimomenten moeiteloos op de schroeven worden toegepast. Voortdurende productieverbeteringen hebben zich bijvoorbeeld vertaald in gezandstraalde afwerkingen en zeskantige uiteinden met scherpe randen die een betere pasvorm op alle schroeven mogelijk maken, inclusief beschadigde schroeven. Laser markeren resulteert in een stevigere stift.

Het nieuwe model, 951GP, werd ontwikkeld in samenwerking met MotoGP- en Superbike-technici en monteurs, met het oog op het verhogen van de schroef- en losschroefsnelheid.

951

T-sleutels met zeskant profiel op drie zijden



mm	L mm	L1 mm	Ø mm	€	W	W
2	125	63	4,0	20,20	5	009510521
2,5	150	63	4,0	20,20	5	009510525
3	150	63	4,0	20,20	5	009510530
3,5	175	76	5,5	20,80	5	009510535
4	175	76	5,5	20,80	5	009510540
4,5	195	87	6,5	22,60	5	009510545
5	195	87	6,5	22,60	5	009510550
6	215	99	8,0	25,50	5	009510560
7	230	109	9,0	28,00	5	009510570
8	250	122	10,0	28,00	5	009510580
9	265	132	11,0	36,00	5	009510590
10	280	142	12,0	36,00	5	009510610
12	305	160	15,0	48,00	3	009510620
14	330	178	17,0	58,00	3	009510640



	€	W	W
951/S6 2,5-3-4-5-6-8 mm	137,50	1	009510687
951/S8 2-2,5-3-3,5-4-4,5-5-6 mm	173,00	1	009510693
951/S14 2-2,5-3-3,5-4-4,5-5-6-7-8-9-10-12-14 mm	407,00	1	009510695



	€	W	W
951/SP6 3-4-5-6-8-10 mm	175,00	1	009510696
951/SPV	34,00	1	009510697



951AS

T-sleutel met zeskantprofiel op drie zijden

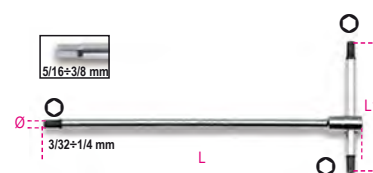

"	L mm	L1 mm	Ø mm	€	W	W
3/32	125	63	4,0	27,00	2	009510750
7/64	150	63	4,0	27,00	2	009510751
1/8	150	63	4,0	27,00	2	009510752
9/64	175	76	5,5	28,00	2	009510753
5/32	175	76	5,5	28,00	2	009510754
3/16	195	86	6,5	31,50	2	009510755
7/32	215	99	8,0	31,50	2	009510757
1/4	230	109	9,0	34,50	2	009510758
5/16	250	122	10,0	36,00	2	009510759
3/8	280	142	12,0	43,50	2	009510760



	€	W	W
951AS/S6X 1/8-3/16-7/32-1/4-5/16-3/8	204,00	1	009510771

951GP

T-handgreepsleutel met één zeskant

Beta's sleutel 951GP is de naam voor snelle, nauwkeurige schroefpassing.

Ontworpen om te voldoen aan enkele belangrijke eisen in de racewereld: het ontwikkelen van hoge koppelwaarden en het garanderen van snel aandraaien.

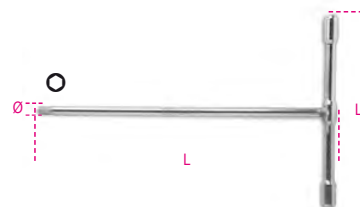

mm	L mm	L1 mm	Ø mm	€	W	W
3	185	130	5	19,00	3	009511530
4	214	150	5	20,00	3	009511540
5	240	165	6	23,00	3	009511550
6	271	180	7	27,00	3	009511560
8	300	200	10	34,00	3	009511580
10	310	200	12	42,00	3	009511610

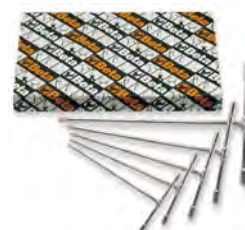

	€	W	W
951GP/S6 3-4-5-6-8-10 mm	165,00	1	009511687

951TX

T-sleutel met Torx®, profiel op drie zijden



Ø	L	L1	Ø	€	U	PC
mm	mm	mm	mm			
T6	125	63	4	25,50	3	009510806
T7	125	63	4	25,50	3	009510807
T8	125	63	4	26,00	3	009510808
T9	125	63	4	26,00	3	009510809
T10	150	63	4	26,50	3	009510810
T15	150	63	4	26,50	3	009510815
T20	175	76	5	27,50	3	009510820
T25	175	76	5	27,50	3	009510825
T27	195	87	6	30,00	3	009510827
T30	195	87	6	30,00	3	009510830
T40	215	99	7	35,00	3	009510840
T45	230	109	8	37,50	3	009510845
T50	250	122	9	39,50	3	009510850



	€	U	PC
951TX/S6 T8-T10-T15-T20-T25-T30	164,00	1	009510866
951TX/S13 T6-T7-T8-T9-T10-T15-T20-T25 T27-T30-T40-T45-T50	383,00	1	009510863

952 T-SLEUTELS MET CARDANGEWRIJCHT EN ZESKANT DOPSLEUTEL

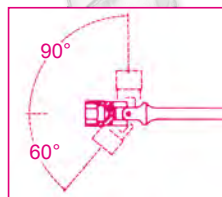

Betrouwbare, nauwkeurige voorpositionering is het geheim van het succes van deze sleutel. Het scharnierende gewricht behoudt zijn functie door de jaren heen, zonder dat er een aanpassing nodig is. Draaihoek dopgedeelte: 60°. In vaste positie 90° te gebruiken. Schuifbare T-handgreep, kan over de hele lengte in de gewenste positie worden vastgezet. Drievoudige maatmarkering op het dopsleuteldeel.

952

T-sleutels met cardangewricht en zeskant dop

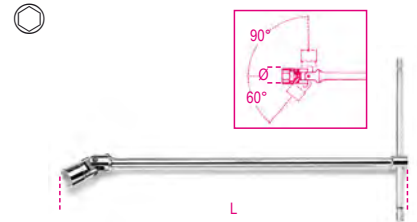

UNI 6743

Ø	Ø	L	€	U	PC
mm	mm	mm			
6	9,5	395	35,00	5	009520006
7	10,7	395	35,00	5	009520007
8	12,1	395	35,00	5	009520008
9	13,2	395	35,00	5	009520009
10	14,6	400	37,50	5	009520010
11	15,8	400	37,50	5	009520011
12	17,0	400	37,50	5	009520012
13	18,7	432	42,50	5	009520013
14	19,7	432	42,50	5	009520014
15	20,9	450	50,50	3	009520015
16	22,0	450	50,50	3	009520016
17	23,4	450	50,50	3	009520017
18	24,7	450	50,50	3	009520018
19	26,0	500	64,00	3	009520019
20	27,4	500	64,00	3	009520020
21	28,5	500	64,00	3	009520021
22	29,7	500	64,00	3	009520022
24	32,4	500	64,00	3	009520024



	€	U	PC
952/S7 8-10-11-13-14-17-19 mm	309,00	1	009520074
952/S10 7-8-10-11-12-13- 14-15-17-19 mm	432,00	1	009520080
952/S18 6-7-8-9-10-11-12 13-14-15-16-17 18-19-20-21-22-24 mm	859,00	1	009520083



	€	U	PC
952/D7 7-8-10-12-13-14-17 mm	280,00	1	009520079

852



852 1/4

79,85

952AS

T-sleutels met cardangewricht en zeskant dop

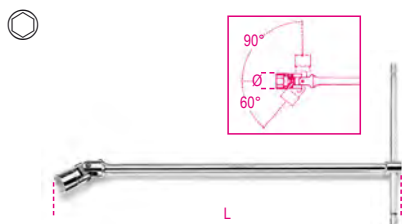

mm	Ø mm	L mm	€	U	PC
1/4	9,5	395	38,50	2	009520256
5/16	12,1	395	38,50	2	009520258
3/8	14,6	400	43,00	2	009520260
7/16	15,8	400	43,00	2	009520261
1/2	18,7	432	46,50	2	009520263
9/16	19,7	432	53,50	2	009520264
5/8	22,0	450	56,00	2	009520266
11/16	23,4	450	56,00	2	009520267
3/4	26,0	500	68,50	2	009520269

952L

T-sleutels met cardangewricht en dop lange uitvoering

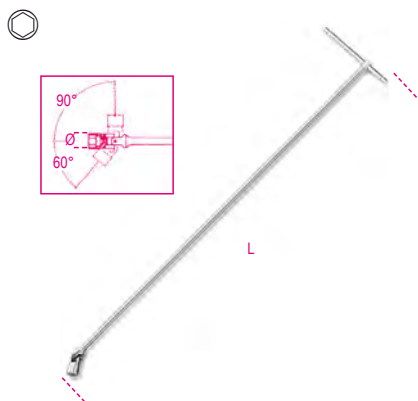

mm	Ø mm	L mm	€	U	PC
10	14,6	930	98,00	1	009520410
12	17,0	1063	98,00	1	009520412
13	18,7	1100	98,00	1	009520413
14	19,7	1100	98,00	1	009520414
15	20,9	1100	108,50	1	009520415
16	22,0	1100	108,50	1	009520416
17	23,4	1100	108,50	1	009520417
18	24,7	1100	108,50	1	009520418
19	26,0	1100	123,50	1	009520419

Beta

952FTX

Stift T-sleutels met cardangewricht voor Torx® schroeven

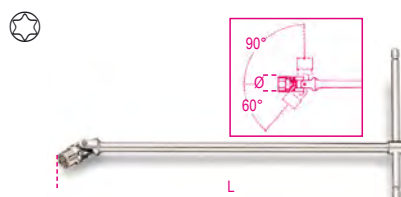

Ø mm	L mm	€	U	PC	
E6	8	392	44,00	2	009520106
E7	9	392	44,00	2	009520107
E8	10	395	48,50	2	009520108
E10	13	400	52,00	2	009520110
E12	15	440	61,00	2	009520112
E14	17	490	74,00	2	009520114
E16	19	490	74,00	2	009520116
E18	21	490	74,00	2	009520118
E20	23	490	74,00	2	009520120



952FTX/S9	€	U	PC
E6-E7-E8-E10-E12 E14-E16-E18-E20	545,00	1	009520141

953

T-sleutels met zeskant profiel en cardangewricht

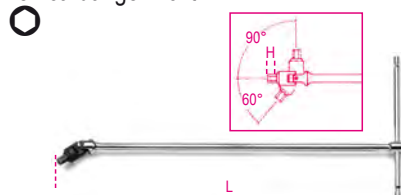

mm	H mm	L mm	€	U	PC
3	5	395	36,50	5	009530130
3,5	6	395	36,50	3	009530135
4	6	395	36,50	5	009530140
4,5	7	395	36,50	3	009530145
5	7	395	36,50	5	009530150
6	9	400	38,00	5	009530160
7	10	425	44,00	3	009530170
8	11	425	44,00	5	009530180
10	13	440	53,00	5	009530200



953/S5	€	U	PC
3-4-5-6-8 mm	191,50	1	009530305
953/S9	361,00	1	009530301
3-3,5-4-4,5 5-6-7-8-10 mm			

953TX

T-Stiftsleutels met cardangewricht voor Torx® schroeven

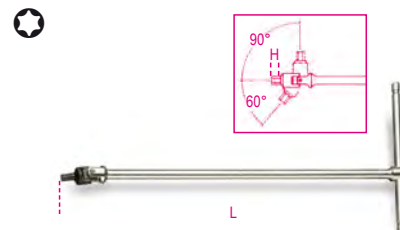

Ø mm	H mm	L mm	€	U	PC
T20	11	396	45,00	2	009530020
T25	11	396	45,00	2	009530025
T27	11	396	45,00	2	009530027
T30	13	400	49,50	2	009530030
T40	13	400	49,50	2	009530040
T45	13	426	53,00	2	009530045
T50	14	442	61,00	2	009530050
T55	14	442	62,00	2	009530055



953TX/S8	€	U	PC
T20-T25-T27-T30 T40-T45-T50-T55	410,00	1	009530060

Beta

Beta

VOERTUIG REPARATIE

Onze reparatie gereedschappen voor voertuigen, die worden gebruikt door de meest veeleisende professionals, zijn ontwikkeld en vervaardigd om te voldoen aan de hoogste normen ter wereld en worden regelmatig getest onder de meest stressvolle bedrijfsomstandigheden.

Al meer dan 50 jaar werken we met trots samen met de grootste kampioenen, die ons non-stop helpen onze producten te verbeteren en te bewijzen volgens de hoogste kwaliteitsnorm.

De voertuig reparatie gereedschappen zijn te vinden in deze secties:

Diagnose	artikel 1438 tot 1499 artikel 1758VT tot 1760TMC
Mototr	artikel 955 tot 989A artikel 1438 tot 1499
Olie en filters	artikel 1438 tot 1499 artikel 1877 tot 1885
Elektrisch systeem	artikel 1438 tot 1499
Startboosters	artikel 1498BC/12 tot 1498/40A
Versnelling	artikel 1438 tot 1499
Ophanging	artikel 1549 tot 1569CP
Remmen	artikel 1438 tot 1499
Wielen	artikel 955 tot 989A
Carrosserie gereedschap	artikel 1302 tot 1369 artikel 1763 tot 1767A
Overig gereedschap	artikel 1875LT tot 3067
Garagekriks	artikel 3029/2T tot 3067/70-13T



955

Bougiesleutel



mm - "	D mm	L mm	€	W	W
16	21	86	17,60	3	009550016
5/8	29	86	17,80	3	009550021
20,8					
13/16					

956C

1/2" Bougiedopsleutels



ISO 11168

mm - "	Ø mm	L mm	€	W	W
14	18,8	70	31,50	3	009560008
9/16	21,4	70	31,50	3	009560010
16	23,6	70	31,50	3	009560011
5/8	27,0	70	33,00	3	009560012
17,8					
11/16					
20,8					
13/16					

956E

3/8" Bougiedopsleutels



ISO 11168

mm - "	Ø mm	L mm	€	W	W
14	18,8	70	36,00	3	009560018
9/16	21,4	70	36,00	3	009560020
16	23,6	70	36,50	3	009560021
5/8	27,0	70	36,50	3	009560022
17,8					
11/16					
20,8					
13/16					

956F

3/8" bougiedopsleutels



mm - "	Ø mm	L mm	€	W	W
14	18,8	70	42,00	1	009560114
9/16	20,5	70	52,00	1	009560116
16					
5/8					

Beta

956L

1/2" vierkant bougie dopsleutels, twaalfkant uiteinde, lange uitvoering



mm - "	Ø mm	L mm	€	W	W
14	19,0	250	70,50	2	009560214
9/16	21,0	250	74,50	2	009560216
16	24,0	250	77,00	2	009560217
5/8					
17,8					
11/16					

957

Bougiesleutel met kniegewricht en T-handgreep

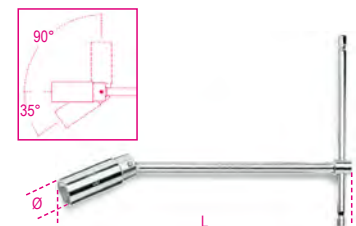

ISO 11168

mm - "	Ø mm	L mm	€	W	W
16	21,4	275	51,50	3	009570000
5/8	27,0	275	59,50	3	009570001
20,8					
13/16					

959

Bougiesleutel met cardangewricht en T-handgreep

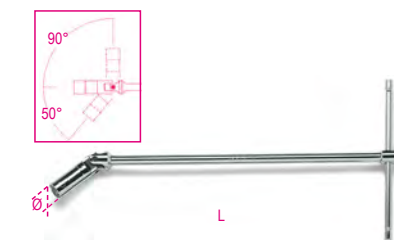

ISO 11168

mm -"	Ø mm	L mm	€		
14	18,8	483	61,00	3	009590009
9/16					
16	21,4	483	68,00	3	009590010
5/8					
20,8	27,0	527	95,00	3	009590011
13/16					

959R

Bougiesbeschermerubber en reserve veertje voor art. 956C - 956E - 957 - 959

	€		
959R/14 956C/14-956E/14	5,75	3	009590223
959R/16 956C/16-956E/16 957/16-959/16	5,75	3	009590224
959R/17,8 956C/17,8-956E/17,8	5,75	3	009590225
959R/20,8 956C/20,8-956E/20,8 957/20,8-959/20,8-959L	5,75	3	009590226

960

1/2" dopsleutel voor diesilverstuivers



mm	Ø mm	L mm	€		
27	36,5	77	37,50	2	009600027

960A

1/2" dopsleutel voor diesilverstuivers

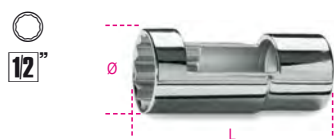

mm	Ø mm	L mm	€		
27	36,5	77	58,00	2	009600017

960BC/C5

5 delig set van dopsleutels voor aansluiting van elektronische injectoren

Set omvat:

- 1 open zeskant dopsleutel, 25 mm
- 1 open zeskant dopsleutel, 27 mm
- 1 open zeskant dopsleutel, 29 mm
- 1 open zeskant dopsleutel, 30 mm
- 1 twaalfkant dopsleutel, 28 mm



12" 22 mm

960BC/C5 € 168,50 1 009600280

280x160x55 mm - 1,9 kg

960ER

Slaghamer voor injector afdichtingen

Bit met conische schroefdraad



L mm 350 € 67,00 1 009600726

960F

Nokksleutel voor verstuurhouders



Ø mm	Ø1 mm	1 mm	2 mm	€		
28,3	22	32	22	43,50	1	009600148

960G

Nokksleutel voor verstuurhouders, voor injectoren van dieselmotoren voor Mercedes vrachtauto's



Ø mm	Ø1 mm	mm	L mm	€		
28,5	22	32	122	46,00	1	009600151

960L

Dopsleutel voor verstuurhouder moeren



Ø mm	Ø1 mm	L mm	€		
30	22	122	50,50	1	009600153

960M

Dopsleutel voor verstuurhouder moeren

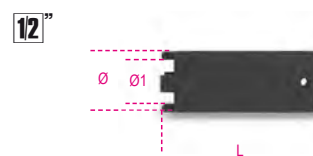

Ø mm	Ø1 mm	L mm	€		
28,5	22	72	37,00	1	009600154

960H/C4

4-delig set dopsleutels voor verstuurhouder moeren



960H/C4 € 131,50 1 009600152

960SL

Dopsleutels voor lambda sondes 1/2" aansluiting

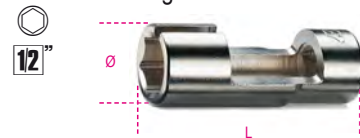

	Ø mm	€		
960SL 85	33	66,00	2	009600085
□ 22xL= 85 mm				
960SL 110	33	75,50	2	009600110
○ 22xL= 110 mm				

960SN

Dopsleutels voor diesel gloeispiralen



mm	Ø mm	mm	L mm	€		
8	12,0	1/4	60	56,00	2	009600834
9	13,3	1/4	60	56,00	2	009600835
10	14,5	3/8	70	66,50	2	009600836

960T/C11

Assortiment van dopsleutels voor het verwijderen en installeren van sensoren

Set bevat:

- 1 Dubbelzijdige zeskant dopsleutel, maat 1" - 11/16" voor oliedruk sensoren
- 1 Open zeskant dopsleutel, 29 mm, voor zuurstof sensoren
- 1 Open twaalfkant dopsleutel, 27 mm, voor injectoren
- 1 Open zeskant dopsleutel, 22 mm, voor vacuummeters
- 1 Open zeskant dopsleutel, 22 mm, 80 mm lang, voor zuurstof sensoren
- 1 Open zeskant dopsleutel, 22 mm, 90 mm lang, voor zuurstof sensoren
- 1 Open zeskant dopsleutel, 22 mm, compact, 30 mm lang, voor zuurstof sensoren
- 1 Open zeskant dopsleutel, 22 mm, compact, 50 mm lang, voor zuurstof sensoren
- 1 Open zeskant en twaalfkant dopsleutel, 22 mm, compact, 34 mm lang, voor zuurstof sensoren
- 1 Open zeskant dopsleutel, 22 mm, buisvormig
- 1 Tap M18x1.5



○ 22 - 29 mm

960T/C11 € 235,00 1 009600031
 ≡ 330x270x25 mm

960T/A

Zeskant open dopsleutel, 29 mm, voor zuurstof sensoren



mm L mm € 1 009600032
 29 90 27,50

960T/B

Twaalfkant open dopsleutel, 27 mm, voor injectoren

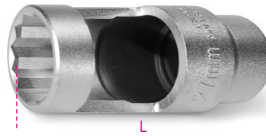

mm L mm € 1 009600033
 27 85 24,90

960T/C

Zeskant open dopsleutel, 22 mm, voor vacuostaten

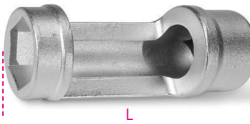

mm L mm € 1 009600034
 22 88 21,80

960T/F

Dubbele zeskant dopsleutel, maat 1" - 1 1/16", voor oliedruk sensoren



mm L mm € 1 009600037
 1 - 1 1/16 28 74 17,10

960T/G

Zeskant open dopsleutel, 22 mm, buisvormig



mm L mm € 1 009600038
 22 25 98 48,50

960T/H

Zes en twaalfkant open dopsleutel, 22 mm, compact, 34 mm lang, voor zuurstof sensoren

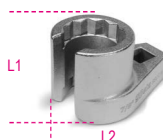

mm L1 L2 mm € 1 009600039
 22 34 55 18,60

960/22EP

Open ring sleutel met kniegewricht voor Lambda sonde

Dubbel zeskant/twaalfkant profiel en 180° knikkoppeling garanderen een veelzijdige toepassing



L mm mm mm € 1 009600052
 300 22 22 61,00

960/C6

3/8" zeskant dopsleutels voor het demonteren en installeren van uitlaatgas sensors

Set bevat:

- 3 korte in de maten, 13, 14, 17 mm
- 3 lange in de maten, 13, 14, 17 mm



960/C6 € 92,00 1 009600055
 ≡ 170x120x50 mm

960/D

Open haakse zeskant dopsleutels, lange uitvoering voor het verwijderen en monteren van uitlaatgas sensors



mm € 1 009600073
 13 14,60
 14 14,60
 17 18,10

960YP

Open haakse zeskant dopsleutels voor het verwijderen en monteren van uitlaatgas sensors

38"



mm	€		
13	15,90	1	009600063
14	16,20	1	009600064
17	21,20	1	009600067

960AVE

Kit voor het testen van de commonrail diesel elektronische injectoren



960AVE	€		
	302,00	1	009600245

300x310x50 mm - 2,0 kg

960EPC/L

Gereedschapsset voor het verwijderen van gloeispiralen met elektrode
M8x1 - M9x1 - M10x1 - M10x1.25



960EPC/L	€		
	995,00	1	009600890

270x230x80 mm - 2 kg

960E-PI/P

Trekapparaat voor brandplaatje injector

• Uitgaande draad M10 voor het gebruik met slagtrekker (Beta 1540)



960E-PI/P	€		
	75,00	1	009600706

300x90x60 mm

960KC-M8/M9/M10

Assortiment van gereedschappen voor het verwijderen van gebroken of beschadigde gloeispiralen
• Voor bougies met draad M8-M9-M10



960KC-M8/9/10	€		
	469,00	1	009600801

380x290x50 mm - 2,3 kg

960KPC

Luchtaangedreven impulstrekker met instelbare slagkracht voor gloeibougies

Slagkracht kan ingesteld worden in 4 posities: 10-20-30-40 Nm

14"

CE



960KPC	€		
	385,00	1	009600780

8-9-10-11-12 mm
420x185x60 mm - 2,8 kg

960UC

Gereedschap voor het verwijderen van vastzittende gloeispiralen M8-M9-M10 met vervormde punten



960UC	€		
	599,00	1	009600900

270x230x80 mm - 2,6 kg

960P

Druk en onderdruk meetapparaat met toebehoren



960P	€		
	280,00	1	009600777

350x320x95 mm - 1,9 kg

960PI

Assortiment van ruimers voor het reinigen van injector zittingen. In kunststof koffer

Voor het verwijderen van residuen van injectie zittingen
- Platte ruimer, Ø 19 - 15 mm, voor universele injectoren
- Platte ruimer, Ø 17 - 17 mm, voor Delphi/Bosch injectoren (BMW/PSA/Renault/Ford)
- Platte ruimer, Ø 19 - 17 mm, voor Bosch injectoren (Mercedes CDI).
- Haakse ruimer, Ø 21 - 17 mm, voor Fiat/veco injectoren.
- Houder



960PI	€		
	135,50	1	009600215

250x130x50 mm - 600 g

960PI/C19

19 delig assortiment gereedschappen voor het reinigen van injectorzittingen

Assortiment bevat:

- 11 platte ruimers, Ø: 14/14 mm - 15.5/15.5 mm - 15/19 mm - 17/19 mm - 17/17.5 mm - 17/19 mm - 17/19.5 mm - 17/20 mm - 18/21 mm - 19 mm - 20/21 mm
- 4 haakse ruimers, Ø: 15.5/15.5 mm - 17/17 mm - 17.5/20.5 mm - 17/21 mm
- Handgrip



960PI/C19 € 351,00 1 009600217
360x230x60 mm

960PI/K36

Kit met borstels voor het reinigen Injector -zitting

1/4



DIN 3126 E6,3

960PI/K36 € 199,00 1 009600218
350x255x74 mm 1253 g

960PI/S

Set voor het reinigen van injectorzittingen.

Set bevat:

- 3 stalen borstels, Ø 18, 22, 25 mm, voor het reinigen van injector zittingen
- 2 borstels, Ø 14 en 16 mm, voor het reinigen van injectorzitting bodems
- 6 pluggen voor het afsluiten van de doorgang naar de ontbrandingskamer
- 1 borstel voor het reinigen van de doorgang naar de ontbrandingskamer
- 1 flexibele bit houder met handgreep

1/4



960PI/S € 181,50 1 009600214
360x140x50 mm - 700 g

960VTC

lek tester voor cilinders van benzinemotoren nadat perslucht in de cilinder is gebracht, kan de meter worden getest op compressielekken



960VTC € 319,00 1 009600261
373x295x70,6 mm - 2,3 kg

960RPI

Luchtspuit voor het schoonblazen van injector zittingen

Voor M8x1 - M9x1 - M10x1 - M10x1.25 gloeispiralen



960RPI € 232,00 1 009600940

960PMC

Verstuivertester, handpomp met manometer



Bar Max. 600 € 868,00 1 009600200

961P6

Electronische video endoscoop met flexibele sonde



CE

- Ondersteund SD kaarten (8 GB)
 - Ondersteund flash geheugen (8 GB)
 - Intern geheugen: 128M
 - TV-OUT uitgang
 - Ondersteund video formaat (MP4, AVI, 3GP)
 - 4 LEDs
 - Voeding door USB aansluiting (interne batterij)
- SPECIFICATIES
- Aantal pixels: 640x480
 - Maximale resolutie: 320x240
 - Sonde lengte: 1 m
 - Camera diameter: 6 mm
 - Video formaat: MPEG4, 3GP, AVI, ASF.
 - Foto formaat: JPEG
 - Zichthoek: 0÷180°
 - Data uitgang: USB kabel en SD kaart • Voeding: 3.7V 2000 mAh batterij

961P6 € 837,00 1 009610000

961P6/S

Flexibele sonde, 6 mm



961P6/S	L mm	€	1	009610006
1	1000	380,00	1	009610006
2	2000	414,00	1	009610262
3	3000	472,00	1	009610263

962

Bandenlichters



L mm	A mm	€	5	009620003
300	21	26,50	5	009620003
400	25	32,50	5	009620004
500	27	41,00	3	009620005
600	27	53,50	3	009620006

962C



962C 277

962P

Bandenlichters met een anti kras rubber bescherming



L mm	A mm	€	Stk	Art. No.
490	25	101,50	1	009620049

962M

Banden monteer en demonteer hulpstuk
Zeer aanbevolen voor runflat banden of laag profiel banden

- Velg beschermd door anti kras klemmen
- Steun voor bandenlichter



962M	€	Stk	Art. No.
	374,00	1	009620501

963

Puntschop



L mm	A mm	€	Stk	Art. No.
400	23	41,00	5	009630001

964

Koevoet



L mm	A mm	€	Stk	Art. No.
400	46	38,50	5	009640001

965

Koevoet met gebogen uiteinde



L mm	A mm	L1 mm	€	Stk	Art. No.
300	16	185	18,30	2	009650013
450	20	312	27,00	2	009650014
600	20	462	31,50	2	009650016



965/S3	€	Stk	Art. No.
	77,00	1	009650019

966/C3

3-delig set breekijzers, met kantelbare gebogen platte kop



966/C3	€	Stk	Art. No.
	145,00	1	009660103

L=200-250-300 mm

355x140x65 mm - 1,8 kg

720LS

Slagdroppen,
Lange en dunne uitvoering



720LS 36	Ø mm	L mm	Ø1 mm	€	Stk	Art. No.
	36	48,0	78 29	69,50	2	007200386

969B

Dopsleutel voor naafmoeren

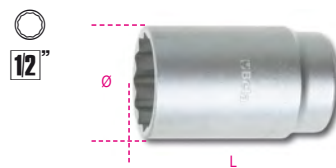

Ø mm	Ø mm	L mm	€	Stk	Art. No.
24	36,0	76	24,10	1	009690124
27	36,0	76	24,50	1	009690127
30	40,0	76	25,00	1	009690130
31	42,0	76	25,00	1	009690131
32	42,5	76	26,50	1	009690132
34	45,0	76	30,50	1	009690134
35	46,0	76	31,50	1	009690135
36	49,0	76	36,00	1	009690136

969/C5

5-delig set dopsleutels voor naafmoeren in kunststof koffer

12"



969/C5	€	Stk	Art. No.
	149,50	1	009690201

969B 30-32-34-35-36

970B

Dopsleutel voor vastdraaien Fiat Daily naafmoeren

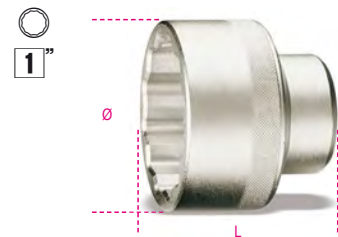

Ø mm	Ø mm	L mm	€	Stk	Art. No.
65	88	75	115,00	1	009700010

970IVECO

Slagdrop
voor Iveco Daily naafmoeren
Voor versies vanaf jaar 2014

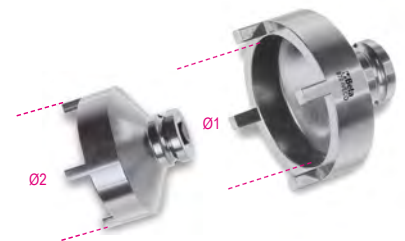

Ø1 mm	Ø2 mm	€	Stk	Art. No.
61,5	74,8	70,00	1	009700011

Beta
Quality Tools

Beta

971/C8

Momentschroevendraaier met toebehoren voor het gecontroleerd vastdraaien van wielventielen met een TMPS sensor



971/C8 € 451,00 1 009710108

583/6	1,2+6 Nm
892/0	
862TX	T10-T15-T20
900L	11-12 mm
986 78	

972/C4BMW

Verwijderset van anti diefstal bouten met ringen, voor BMW en Mini auto's



972/C4 BMW € 250,00 1 009720004

516x145x66 mm - 3,8 kg

972/C10

Gereedschap voor het verwijderen van beschadigde wielbouten
Voor gebruik op anti diefstal en conventionele bouten



972/C10 € 324,00 1 009720010

290x250x60 mm - 2,4 kg

973

Set van 4 nylon bandenhoezen

Geschikt voor de volgende velgmaten:
14" ÷ 18" artikelnummer 009730014
19" ÷ 22" artikelnummer 009730019



- Behoudt en beschermt het wiel tegen krassen en stof
- Tijdens de opslag, het voorkomt het voortijdig aantasten van de rubber polymeren bij zomer of winterbanden
- Een pictogram maakt indicatie van de wielpositie (rechts/links voor of rechts/links achter) mogelijk
- Voorzien van handvaten voor gemakkelijk transport
- Stof: nylon, wasbaar

973 14-18 € 119,00 1 009730014
973 19-22 € 132,50 1 009730019

978 - 979

Kruissleutels

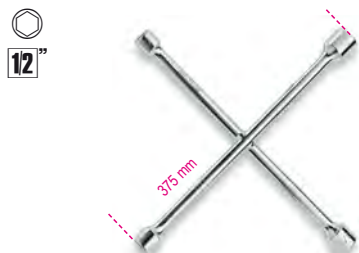

UNI/ISO 6788 DIN 3119

978 € 72,00 2 009780001
17x19x21x22 mm
979 € 72,00 2 009790001
17x19x22x1/2 mm

982

Kruissleutel

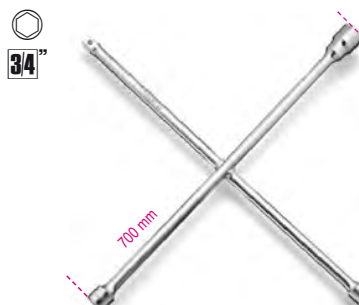

UNI/ISO 6788 DIN 3119

24x27x32x3/4 mm € 175,00 1 009820001

983PM

Schuurborstel voor het reinigen van wielnaven



Ø1 90 mm
Ø2 150 mm
€ 86,00 1 009830010

983 PM/R-DA

schuurschijven, paar, voor artikel 983PM



Ø 150 mm € 79,00 1 009830050

984

Tang voor het verwijderen van wielbout afdekkapjes



L 195 mm H 4 mm € 30,50 1 009840005

985/B7

7-delig assortiment van geleiderpennen voor het monteren van wielen

Bevat de volgende maten:

- M12x1.25 uitw.
- M12x1.25 inw.
- M12x1.5 uitw.
- M12x1.5 inw.
- M14x1.25 uitw.
- M14x1.5 uitw.
- M16x1.5 uitw.



C985/B7 € 115,50 1 009850007



985M

Uitwendige geleider pennen voor wielmontage



	L mm	€		
985M M12X1,25	150	16,20	1	009850101
985M M12X1,50	150	16,20	1	009850102
985M M14X1,25	150	16,50	1	009850103
985M M14X1,50	150	17,20	1	009850104
985M M16X1,50	150	18,20	1	009850105

985F

Inwendige geleider pennen voor wielmontage



	L mm	€		
985F M12X1,25	150	22,20	1	009850106
985F M12X1,50	150	23,10	1	009850107

986 48

Ventielschroevendraaier, kort model

Automatisch grip van het ventiel



	L mm	L1 mm	€		
	18	48	16,90	1	009860048

986 78

Ventielschroevendraaier.

Automatisch grip van het ventiel



	L mm	L1 mm	€		
	18	78	16,90	1	009860078

986PT

Ventiel schroevendraaier,
vooraf gecallibreerd, 0,4 Nm

automatisch vastklemmen van het ventiel
slijp mechanisme voorkomt
dat de ventiel afdichting
kan beschadigen



	L mm	L1 mm	€		
	19	120	60,50	1	009860140

987

Ventiel trekker met rubber bescherming



	L mm	€		
	310	34,50	1	009870001

987AR

Ventieltrekker
met anti kras steunpunt

- Rubber en nylon steunpunt voor lichtmetalen en stalen velgen
- Ventiel snelkoppeling, draaien is niet nodig



	L mm	€		
	305	117,00	1	009870021

987P

Ventieltrekker, vervaardigd uit kunststof

Door de handgreep is het mogelijk het binnenste van de ventiel te bereiken



	L mm	€		
	335	29,00	1	009870011

988/K4

4-delig set krasbestendige platte kunststof
beitels



	€		
988/K4 A= 19-21-25-38 mm	31,00	1	009880104

989

Wielgewichttang



	L mm	€		
	250	54,50	2	009890001

989A

Tang voor het verwijderen van geplakt
wiellood.



Neuse bekken speciaal ontworpen om
het wiellood te verwijderen zonder contact te maken met de velg

	L mm	€		
989A	220	37,00	1	009890011

989B

Wielgewichttang

Functies:

- verwijderen van plakgewichten voor lichtmetalen velgen
- verwijderen van gewichten voor stalen velgen
- hamer met verwijderbare PE-HD bekleding voor klefgewichten en stalen velgen
- Speciale bekken voor stalen velgen gewichten



	L mm	€		
	230	70,00	1	009890015

Beta
Quality Tools

990

Pincet met rechte smalle gegroefde bekken vervaardigd uit roestvast staal gepolijste uitvoering



L mm 130 € 13,60 5 009900001

991

Pincet met gebogen smalle gegroefde bekken vervaardigd uit roestvast staal gepolijste uitvoering



L mm 130 € 15,90 5 009910001

992

Pincet met rechte smalle gegroefde bekken en geleider vervaardigd uit roestvast staal gepolijste uitvoering



L mm 150 € 17,40 5 009920001

993

Pincet met gebogen smalle gegroefde bekken en geleider vervaardigd uit roestvast staal gepolijste uitvoering



L mm 145 € 18,70 5 009930001

993PL

Pincet met gebogen smalle gegroefde bekken vervaardigd uit roestvast staal PVC geïsoleerd



L mm 150 € 18,70 3 009930010

993G

Pincet met gebogen smalle gegroefde bekken met geleider vervaardigd uit roestvast staal gepolijste uitvoering



L mm 160 € 17,10 3 009930030

994

Pincet met rechte brede gegroefde bekken vervaardigd uit roestvast staal gepolijste uitvoering



L mm 150 € 13,90 5 009940001

994PL

Pincet met rechte brede gegroefde bekken vervaardigd uit roestvast staal PVC geïsoleerd



L mm 150 € 17,00 3 009940010

994TF

Pincet met rechte brede gegroefde bekken, anti-magnetisch en zuurbestendig vervaardigd uit roestvast staal halfgepolijste uitvoering



L mm 150 € 21,70 3 009940020

996

Pincet met rechte spatel bekken vervaardigd uit roestvast staal gepolijste uitvoering



L mm 150 € 15,30 5 009960001

998

Pincet met zelfklemmende rechte gegroefde spatel bekken vervaardigd uit roestvast staal gepolijste uitvoering



L mm 155 € 25,50 5 009980001

999

Pincet met halfronde bekken, anti-magnetisch en zuurbestendig vervaardigd uit roestvast staal halfgepolijste uitvoering



L mm 115 € 20,20 3 009990011

999A

Pincet met korte puntige bekken, anti-magnetisch en zuurbestendig vervaardigd uit roestvast staal halfgepolijste uitvoering



L mm 120 € 18,10 3 009990015

999B

Pincet met sterke rechte bekken, anti-magnetisch en zuurbestendig vervaardigd uit roestvast staal halfgepolijste uitvoering



L mm 120 € 18,40 3 009990017

999C

Pincet met dunne spitse bekken, anti-magnetisch en zuurbestendig vervaardigd uit roestvast staal halfgepolijste uitvoering



L mm 110 € 18,80 3 009990019

999D

Pincet met dunne gebogen spitse beken, anti-magnetisch en zuurbestendig vervaardigd uit roestvast staal halfgepolijste uitvoering



L mm 115 € 20,70 3 009990021

999E

Pincet met gebogen spitse beken, anti-magnetisch en zuurbestendig vervaardigd uit roestvast staal halfgepolijste uitvoering



L mm 120 € 18,80 3 009990023

999G

Pincet met rechte spitse beken, vergrendeling, anti-magnetisch en zuurbestendig vervaardigd uit roestvast staal halfgepolijste uitvoering



L mm 140 € 18,80 3 009990027

999/B6N

set van 6 veerpincetten, zuur- en magneetbestendig



999/B6N € 125,00 1 009990060
999-999A-999B
999C-999D-999E

1002

Zelfklemmende ronde en gekartelde schaar vervaardigd uit roestvast staal



L mm 160 € 30,50 2 010020001

1008

Lange buigtang, platte beken en PVC handgreep



ISO 5745

L mm 160 L1 mm 51,5 € 30,00 5 010080006

1008BM

Lange buigtangen, platte beken twee componenten handgreep



ISO 5745

L mm 160 L1 mm 51,5 € 34,50 3 010080036

1009

Extra lange buigtang, anti-slip handgrepen uit dubbele PVC, verchromd



ISO 5745

L mm 160 L1 mm 56,5 € 30,00 2 010090006

1009L/A

Extra lange buigtang, lange halfronde beken en PVC handgreep



L mm 283 L1 mm 80 € 35,50 2 010090008

1009L/B

Extra lange buigtang, met lange halfronde beken, 45° gebogen en PVC handgreep



L mm 273 L1 mm 73 € 37,00 2 010090009

1009L/C

Extra lange buigtang met lange halfronde 90° gebogen beken PVC handgreep



L mm 253 L1 mm 45 € 39,00 2 010090010



1009L/D

Extra-lange, buigtang met dubbelwerkend scharnier, anti-slip dubbel gelaagde PVC handgrepen



1009L/DP

Gebogen extra lange buigtangen met dubbelwerkend scharniers, 45°, anti-slip dubbel gelaagde PVC handgreep



1009L/DP-S2

2-delig set van extra lange buigtangen met dubbelwerkend scharnier



1009L/DP-S2 € 83,00 1 010090060

1010

Lange buigtang, ronde bekken en PVC handgreep

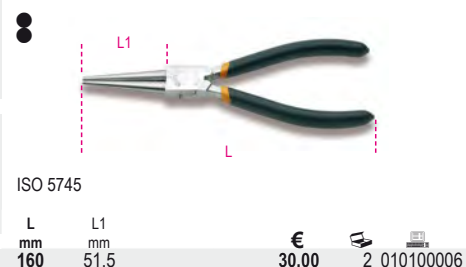

1010BM

Lange buigtang, ronde bekken twee componenten handgreep



BORGVEERTANG (SEEGER TYPE)

PERFECTE UITLIJNING

Tests hebben aangetoond dat de borgveertangen van Beta een uitstekende uitlijning van de seeger (snapping) bieden, gebaseerd op de speciale omgekeerde kegelgeometrie van de punten, verkregen door de speciale koud-perstechnologie tijdens de fabricage.



VERMINDERDE TIPBREUK

De tangen van Beta zijn uitgerust met ingebouwde koudgeperste punten, die een grotere duurzaamheid bieden in vergelijking met die van concurrenten, zowel bij gebruik als bij onbedoeld vallen.



1031/S4

4-delig set borgveertangen



1031/S4 € 120,50 1 010310000

1032 180 ○ 19 ÷ 60 mm
1034 170 ○ 19 ÷ 60 mm
1036 175 ● 19 ÷ 60 mm
1038 175 ● 19 ÷ 60 mm

1033

Borgveertangen, inwendig 45° gebogen punten PVC handgreep



L mm	∅ mm	€	U	1033
140x0,9	8÷12	30,00	5	010330013
140x1,3	12÷25	30,00	5	010330014
180	19÷60	31,00	5	010330017
225	40÷100	38,00	3	010330021

1034

Borgveertangen, inwendig 90° gebogen punten PVC handgreep



L mm	∅ mm	€	U	1034
130x0,9	8÷12	30,00	5	010340013
130x1,3	12÷25	30,00	5	010340014
170	19÷60	31,00	5	010340017
210	40÷100	38,00	3	010340021
290	85÷200	55,00	2	010340028

1034L

Tang met 90° gebogen lange bekken voor elastische borgringen, PVC handgreep



L mm	Ø mm	€	Hand icon	Computer icon
190	40÷100	80,50	2	010340320

1036

Borgveertangen, uitwendig rechte punten PVC handgreep



UNI 7915 DIN 5254

L mm	Ø mm	€	Hand icon	Computer icon
140x0,9	3÷10	28,00	5	010360013
140x1,3	10÷25	28,00	5	010360014
175	19÷60	29,00	5	010360017
225	40÷100	36,50	3	010360021
300	85÷200	59,50	2	010360028

1037

Borgveertangen, uitwendig 45° gebogen punten PVC handgreep



UNI 7915 DIN 5254

L mm	Ø mm	€	Hand icon	Computer icon
140x0,9	3÷10	32,00	5	010370013
140x1,3	10÷25	31,50	5	010370014
175	19÷60	33,00	5	010370017
225	40÷100	39,50	3	010370021

1038

Borgveertangen, uitwendig 90° gebogen punten PVC handgreep



UNI 7915 DIN 5254

L mm	Ø mm	€	Hand icon	Computer icon
135x0,9	3÷10	32,00	5	010380013
135x1,3	10÷25	31,50	5	010380014
175	19÷60	33,00	5	010380017
220	40÷100	39,50	3	010380021
300	85÷200	64,00	2	010380028

Beta

1039

Omkeerbare borgveertang voorin en uitwendige borgveren uitvoering PVC handgreep



L mm	Ø mm	Ø mm	€	Hand icon	Computer icon
150	10÷15	6÷25	69,50	2	010390015

1558/C4

Borgveertang, voor interne en externe ringen, bediening door schroefdraad

Het vierkante aandrijf gedeelte maakt het mogelijk om grote kracht te ontwikkelen in zowel het monteren als in het demonteren
Meegeleverde punten:
Ø 2.5-3-3.5 mm



Ø mm	Ø mm	€	Hand icon	Computer icon
1558/C4 5,5 ÷ 77	5,5 ÷ 77	185,00	1	015580100

330x220x50 mm - 900 g

1044N

Waterpomptang, opgelegd scharnier, antislip handgrepen met PVC-coating

model met 8 posities



L mm	A max mm	L1 mm	€	Hand icon	Computer icon
250	46	48	27,50	5	010440025

1047

Waterpomptangen, instelbaar door drukknop. Handgrepen voorzien van dubbele anti-slip PVC

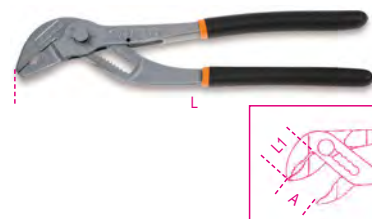

L mm	A max mm	L1 mm	€	Hand icon	Computer icon
180	30	29	47,00	2	010470180
240	36	35	49,50	2	010470240
300	50	48	70,50	1	010470300

1047BM

Waterpomptangen, verstelbaar door drukknop, twee componenten handgreep



L mm	A max mm	L1 mm	€	Hand icon	Computer icon
240	36	35	56,00	2	010470340

Beta

1048N - POLIGRIP WATERPOMPTANG, PIN VERBINDING

UITSTEKENDE GRIP EN UNIEK GEBRUIKSGEMAK

- Tandgeometrie en hoek ontworpen voor effectieve, veilige grip op zeskant en cilindrische profielen
- Inductie geharde vertanding voor een langere levensduur
- Bredere bek/handvat voor verbeterd ergonomisch gebruik
- Afstand-houder welke handletsel voorkomt
- Innovatieve Anti-slip PVC-handgrepen
- Ongeëvenaard gebruiksgemak en comfort dankzij groter contactoppervlak van de handgreep



1048N

Waterpomptang met Slip-proof PVC gecoate handgrepen



ISO 8976

L mm	A max mm	L1 mm	S mm	€	🔧	📦
175	36	31	11	34,50	3	010480910
250	46	38	13	37,00	5	010480915
300	60	44	14.8	55,00	2	010480920
400	96	81	19	99,00	1	010480940

1048N/D3

Set van waterpomptangen

gefosfateerde kop



1048N/D3 175-250-300 mm	€ 126,50	🔧 1	📦 010480923
----------------------------	----------	-----	-------------

1048BM

Waterpomptangen, doorgestoken scharnier, twee componenten handgreep

· nieuw model 9 instelposities



ISO 8976

L mm	A max mm	L1 mm	€	🔧	📦
250	48	39	49,00	3	010480215

1048VN

Waterpomptangen met doorgestoken scharnier, oranje gelakt

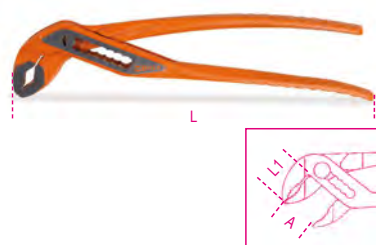

ISO 8976

L mm	A max mm	L1 mm	€	🔧	📦
175	36	31	30,00	3	010480111
250	46	38	34,50	5	010480116
300	60	44	50,00	2	010480121

1050

Griptang dubbel verstelbaar



L mm	€	🔧	📦
220	87,50	2	010500022

1051

Griptang dubbel verstelbaar lange bekken



L mm	€	🔧	📦
255	94,00	2	010510025

1051GM

Griptang dubbel verstelbaar beweegbare bek



L mm	€	🔧	📦
255	101,00	2	010510250

1051L

Griptang met grote bekbreedte en dubbel verstelbaar



L mm	€	🔧	📦
270	110,00	2	010510100

1051XL

Griptang met extra lange bekken en grote bekbreedte, dubbel verstelbaar



L mm	€	🔧	📦
270	129,50	2	010510140

1052

Verstelbare griptangen halfronde bekken



L mm	A1 max mm	€	🔧	📦
140	22	28,00	3	010520014
190	36	33,50	3	010520019
240	42	36,50	3	010520024
300	55	59,50	2	010520030

1053

Verstelbare griptang beweegbare bek

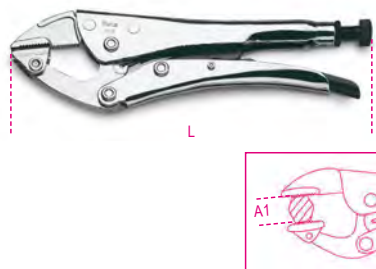

L mm	A1 max mm	€	Hand icon	Computer icon
240	35	49,00	2	010530024

1054

Verstelbare griptang rechte bekken

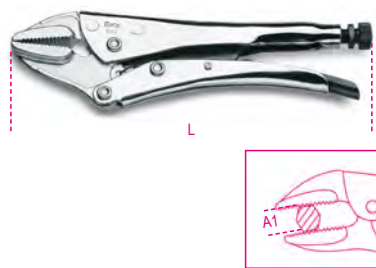

L mm	A1 max mm	€	Hand icon	Computer icon
235	40	43,00	2	010540022

1055

Verstelbare griptang rechte bekken

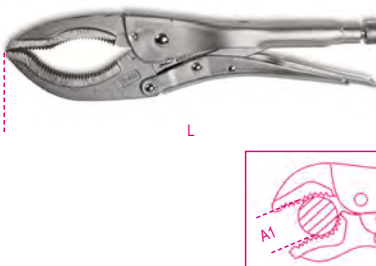

L mm	A1 max mm	€	Hand icon	Computer icon
270	75	38,50	2	010550027

1055D

verstelbare zelfborgende tang, voor moeren en cilindrische profielen

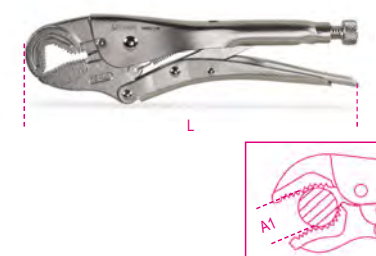

L mm	A1 max mm	€	Hand icon	Computer icon
195	22	30,50	2	010550119
235	43	34,00	2	010550123

1056

Instelbare griptangen voor koelinstallateurs

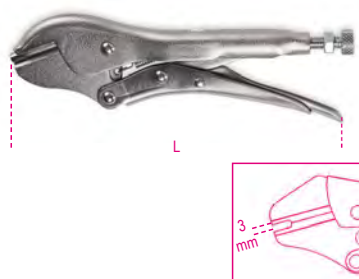

L mm	€	Hand icon	Computer icon
195	30,50	2	010560017

1057A

Automatische griptang met instelbare klemkracht.



L mm	€	Hand icon	Computer icon
240	63,50	2	010570124

1058

Verstelbare griptang lange bekken

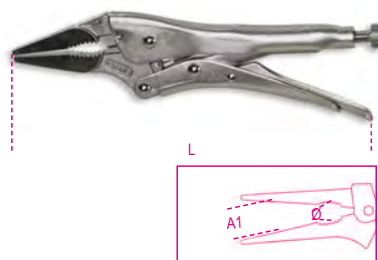

L mm	A1 max mm	Ø max mm	€	Hand icon	Computer icon
175	34	26	38,50	2	010580017
225	46	31	43,00	2	010580025

1059

Verstelbare griptang met in hoogte verstelbare bek

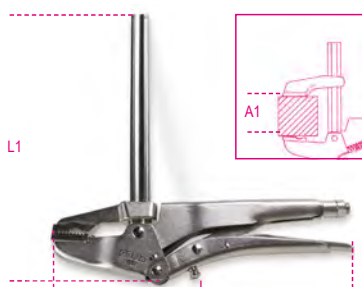

L1 mm	L mm	A1 mm	€	Hand icon	Computer icon
160	255	120	65,00	1	010590016
270	255	220	68,00	1	010590027

1060

Verstelbare griptang vorkbekken

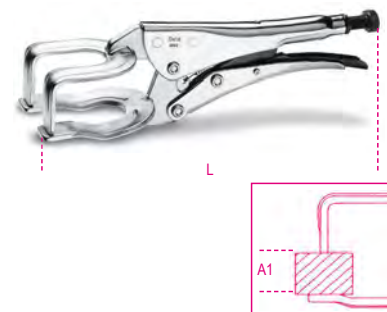

L mm	A1 max mm	€	Hand icon	Computer icon
200	50	48,00	2	010600020
280	80	61,50	2	010600028

1061

Verstelbare griptang vorkbekken

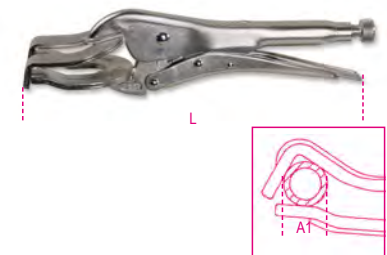

L mm	A1 max mm	€	Hand icon	Computer icon
275	80	50,50	2	010610027

1062

Verstelbare griptang C-vormige bekken

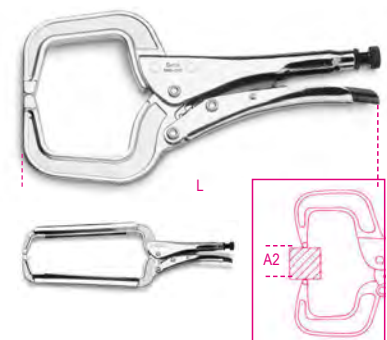

L mm	A2 max mm	€	Hand icon	Computer icon
170	50	37,50	2	010620017
290	120	50,00	2	010620029
460	255	66,50	1	010620045



1062AL

Verstelbare griptang C-vormige aluminium bekken

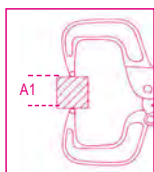

L mm	A1 max mm	€	Icon	Icon
275	88	66,00	2	010620327

1062GM

Verstelbare griptang C-vormige scharnierende bekken

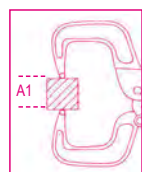

L mm	A1 max mm	€	Icon	Icon
170	45	41,50	2	010620217
290	88	57,50	2	010620229
460	255	77,00	1	010620245

1063

Verstelbare griptang brede vlakke bekken

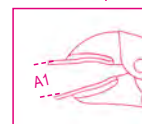

L mm	A1 max mm	€	Icon	Icon
200	31	47,00	2	010630021

1064

Verstelbare ketting griptang



L mm	Ø mm	€	Icon	Icon
230	150	65,00	2	010640023

1065F

Ponstang



Ø mm	L mm	€	Icon	Icon
5	228	142,00	1	010650010
6	228	143,00	1	010650015

1065P

Kantzettang



L mm	€	Icon	Icon
228	147,50	1	010650020

1066

verstelbare zelfborgende tang, 90° sluihoek

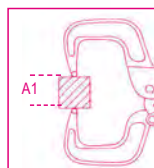

L mm	A1 max mm	g	€	Icon	Icon
210	55	500	90,00	1	010660021

1067

Instelbare griptangen voor pijpen, speciale bekken voor het klemmen van ronde en afwijkende delen

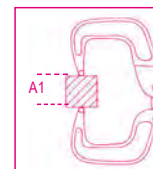

L mm	A1 max mm	€	Icon	Icon
285	76	55,50	1	010670285
380	89	60,50	1	010670380

1077

Plaatbuigtang, recht model PVC handgreep



L mm	A mm	L1 mm	€	Icon	Icon
280	60	53	62,00	1	010770026

1078

Plaatbuigtang, 45° gebogen model PVC handgreep



L mm	A mm	L1 mm	€	Icon	Icon
280	60	77	64,50	1	010780026

1080D

Zijkniptang, handgreep voorzien van twee laag anti-slip PVC materiaal

Voor het knippen van kunststof



α	L mm	L1 mm	€	Icon	Icon
15°	160	22	32,00	3	010800015
45°	160	22	38,00	3	010800045

1081

Zijkniptang met bijna vlakke snijvorm, Dubbele PVC antislip beklede handgreep

• Voor elektronica en zware micro mechanische werkzaamheden

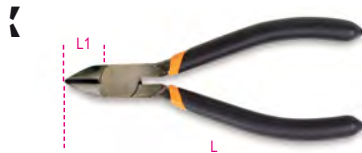

L	L1	€	Hand	Computer
mm	mm			
125	16	34,00	3	010810130

1082

Zijkniptangen, verchroomd, handgreep bestendig tegen slippen door een dubbele PVC laag



L	L1	€	Hand	Computer
mm	mm			
140	20	30,50	5	010820004
160	22	32,00	5	010820006

1082G

Zijkniptangen, handgreep voorzien van dubbel gelaagde anti slip PVC, industriële afwerking



L	L1	€	Hand	Computer
mm	mm			
140	20	26,50	5	010820064
160	22	27,50	5	010820066

1082BM

Zijkniptangen, twee componenten handgreep



L	L1	€	Hand	Computer
mm	mm			
140	20	38,00	3	010820034
160	22	41,50	3	010820036

1082GBM

Zijkniptangen, twee componenten handgreep, industriële afwerking



L	L1	€	Hand	Computer
mm	mm			
140	20	33,00	3	010820264
160	22	37,50	3	010820266

1084

Zijkniptangen, zware uitvoering, verchroomd, handgreep bestendig tegen slippen door een dubbele PVC laag



L	L1	€	Hand	Computer
mm	mm			
160	22	35,50	5	010840006
200	28	45,50	3	010840010

1084G

Zijkniptangen, handgreep voorzien van dubbel gelaagde anti slip PVC, industriële afwerking



L	L1	€	Hand	Computer
mm	mm			
160	22	30,00	5	010840066
200	28	37,50	3	010840070

1084BM

Zijkniptangen, zware uitvoering, verchroomd, twee componenten handgreep



L	L1	€	Hand	Computer
mm	mm			
160	22	44,00	3	010840036
200	28	57,00	3	010840040

1084GBM

Zijkniptangen, twee componenten handgreep, industriële afwerking



L	L1	€	Hand	Computer
mm	mm			
160	22	45,50	3	010840266
200	28	58,50	3	010840270

1088

Kopkniptangen, zware uitvoering PVC handgreep

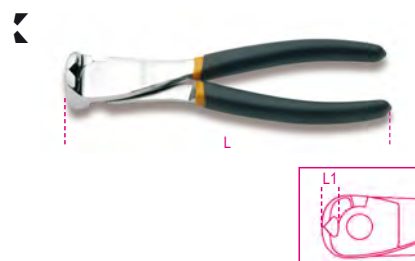

L	L1	€	Hand	Computer
mm	mm			
160	9	44,00	2	010880006
200	11	57,50	2	010880010

1088BM

Kopkniptangen, twee componenten handgreep



L	L1	€	Hand	Computer
mm	mm			
160	9	53,00	2	010880036
200	11	69,50	2	010880040



1092V

Hefboom kopkniptangen

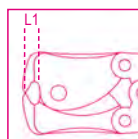

UNI/ISO 5748

L mm	L1 mm	mm	€	5	10
180	8	2,0	161,50	2	010920280
200	9	2,5	171,50	2	010920310

1094V

Hefboom zijkniptangen



UNI/ISO 5749

L mm	L1 mm	mm	€	5	10
200	23	2,5	161,50	2	010940200

1095N

Hefboom zijkniptangen gebruneerde snijgedeelte, handgreep



L mm	L1 mm	mm	€	5	10
195	26	1,6	60,00	2	010950010

1096

Nijptangen



ISO 9243

L mm	L1 mm	€	5	10
160	21	22,60	5	010960016
200	23	26,00	5	010960020
250	30	34,50	5	010960025

1098

Moniertangen



ISO 9242 DIN 5242

L mm	L1 mm	€	5	10
190	12	21,80	5	010980190
220	13	24,60	5	010980220
250	15	29,00	5	010980250
280	18	33,00	5	010980280

1098PL

Moniertangen PVC handgreep



ISO 9242 DIN 5242

L mm	L1 mm	€	5	10
220	13	26,00	5	010980320
250	15	31,50	5	010980350
280	18	36,00	5	010980380

1101

Boutenscharen gefosfateerde messen uitvoering rubber handgrepen



L mm	L mm	€	5	10
300	12	65,00	2	011010030
350	14	79,00	2	011010035
450	18	98,00	1	011010045
600	24	135,00	1	011010060
750	30	175,00	1	011010075
900	36	235,00	1	011010090

L mm	R = 80 Kgf/mm² Ø mm	R = 140 Kgf/mm² Ø mm	g
300	5	4	745
350	6	5	1043
450	7	6	1537
600	9	7	2540
750	11	8	3870
900	12	9	6170

1101R

Reserve messen voor model 1101 gefosfateerd



mm	1101	€	5	10
300	300	39,00	1	011010130
350	350	45,00	1	011010135
450	450	59,00	1	011010145
600	600	79,00	1	011010160
750	750	95,00	1	011010175
900	900	129,00	1	011010190

1102

Boutenschaar, kleine uitvoering gefosfateerde messen gelakte plaatmetalen handgreep R= 80 Kgf/mm²



L mm	mm	€	5	10
230	4	49,00	3	011020020

1103

Boutenschaar voor metalen pijpen en betonijzer

Max. Ø = 12 mm
Max. Ø (HRC 48) = 6 mm



L mm	€	5	10
950	175,00	1	011030090

1103R

reservekop voor artikel 1103



1103R 950	€	5	10
	105,00	1	011030190

1104

Industriële kabelschaar voor flexibele kabels, handgrepen voorzien van kunststoffen grepen



R=80 Kgf/mm²

L mm	Ø mm	€		
420	12	169,00	1	011040004
600	16	249,00	1	011040006

1104R

Reserve messen voor item 1104



mm	€		
420	109,00	1	011040014
600	150,00	1	011040016

1105

Holpijpen vervaardigd uit gebruneerd staal



D mm	L mm	€		
2	27	16,70	1	011050002
3	27	16,70	1	011050003
4	27	16,70	1	011050004
5	27	16,70	1	011050005
6	27	16,70	1	011050006
7	27	16,70	1	011050007
8	27	16,70	1	011050008
9	27	16,70	1	011050009
10	27	16,70	1	011050010
12	27	20,80	1	011050012
14	27	20,80	1	011050014
16	27	20,80	1	011050016
18	27	20,80	1	011050018
20	27	20,80	1	011050020
22	32	25,50	1	011050022
24	32	25,50	1	011050024
26	32	25,50	1	011050026
28	32	25,50	1	011050028
30	32	25,50	1	011050030
32	37	33,50	1	011050032
34	37	33,50	1	011050034
36	37	33,50	1	011050036
38	37	33,50	1	011050038
40	37	33,50	1	011050040
42	42	38,50	1	011050042
44	42	38,50	1	011050044
46	42	38,50	1	011050046
48	42	38,50	1	011050048
50	42	38,50	1	011050050

1105T20

Slaghouder voor holpijpen 1105, 2 tot 20 mm



L mm	€		
110	81,50	1	011050200

1105T30

Slaghouder voor holpijpen 1105, 3 tot en met 30 mm



L mm	€		
175	185,00	1	011050205

1105T50

Slaghouder voor holpijpen 1105, 2 tot en met 50 mm



L mm	€		
175	183,50	1	011050207

1105AD-50

Holpijpadapter voor model 1105T50



Ø mm	€		
57	114,50	1	011050210

1105/C10T

10 delig assortiment holpijpen, 3 tot 20 mm, en 1 toebehoren



1105C/10T	€		
	187,00	1	011050250

1105	3 - 4 - 6 - 8 - 10 - 12 - 14 - 16 - 18 - 20 mm
1105T20	

135x92x32 mm

1105/C16T

assortiment van 15 holpijpen 3 tot 30 mm en 1 accessoire



1105C/16T	€		
	347,00	1	011050255

1105	3 - 4 - 6 - 8 - 10 - 12 - 14 - 16 - 18 - 20 - 22 - 24 - 26 - 28 - 30 mm
1105T30	

240x210x60 mm

1105/C32T

assortiment van 29 holpijpen, 2 tot 50 mm en 3 accessoires"



1105C/32T	€		
	681,00	1	011050257

1105	2 - 3 - 4 - 5 - 6 - 7 - 8 - 9 - 10 - 12 - 14 - 16 - 18 - 20 - 22 - 24 - 26 - 28 - 30 - 32 - 34 - 36 - 38 - 40 - 42 - 44 - 46 - 48 - 50 mm
1105T50	
1105AD-50	

455x380x115 mm

1112

Blikscharen rechte brede bladen

R= $\frac{S}{L}$ 60 Kgf/mm²



L mm	L1 mm	S mm	A mm	€		
200	50	0,5	26	29,00	2	011120020
250	62	0,8	33	36,00	2	011120025
300	76	1,0	37	47,00	2	011120030
375	76	1,2	44	69,50	1	011120037

1114

Blikschaar met rechte dunne bekken

R = 60 Kgf/mm²

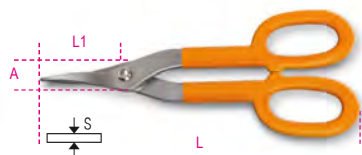

L	L1	S	A	€		
mm	mm	mm	mm			
250	58	0,5	15	32,00	1	011140265
350	76	1	22	43,00	1	011140340

1118

Veiligheids bandijzerschaar

Fe = normaal staal
Inox = roestvast staal



L	L1	Fe	Inox	€		
mm	mm	S mm	S mm			
310	42	1	0,8	53,50	2	011180001

1120A

Knabbelschaar

Fe = normaal staal



L	Fe	€		
mm	S mm			
280	1,2	84,50	1	011200101

1120ARL - ARG

Reserve onderdeel voor item 1120A



	€		
1120ARL	20,70	1	011200110
1120ARG	28,50	1	011200120

1122

Hefboom blikschaar, rechte bekken

inox = roestvast staal



L	L1	Inox	A	€		
mm	mm	S mm	mm			
250	40	1	24	42,00	2	011220020

1123

Hefboom blikschaar, gebogen bekken, rechts knippend

inox = roestvast staal



L	L1	Inox	A	€		
mm	mm	S mm	mm			
250	40	1	24	42,00	2	011230020

1124

Hefboom blikschaar, gebogen bekken, links knippend

inox = roestvast staal



L	L1	Inox	A	€		
mm	mm	S mm	mm			
250	40	1	24	42,00	2	011240020

1125

Hefboom blikschaar, voor recht en rechts knippend

inox = roestvast staal



L	L1	Inox	A	€		
mm	mm	S mm	mm			
250	35	1	46	62,00	2	011250020

1126

Hefboom blikschaar, voor recht en links knippend

inox = roestvast staal



L	L1	Inox	A	€		
mm	mm	S mm	mm			
250	35	1	46	62,00	2	011260020

1122 - 1125MOL



		€		
1122 MOL	1122 - 1124	1,96	1	011220010
1123 MOL	1123	1,77	1	011230010
1125 MOL	1125 - 1126	1,77	1	011250040

1127

Elektricienschaar, rechte bladen



L	L1	€		
mm	mm			
150	35	18,70	5	011270001

1128BAX

Dubbel snijdende electricien schaar, met trapsgewijze ruimers in roestvast staal met DLC-coating

Dubbel snijdende werking: een speciale nok op het draaipunt maakt het mogelijk de bladen in de lengte te verplaatsen waardoor de snijkraacht toeneemt bij het sluiten van de bladen.

Vorm en ruimers: ontworpen voor het vergroten van gaten in kunststof van 13 mm tot 24 mm.

DLC coating: DLC (diamond-like carbon) is een innovatieve, op koolstof gebaseerde coating: de grote hardheid en het lage coefficient van wrijving welke ontstaat van het gelijktijdig aanwezig zijn van koolstof, in de vorm van grafiet, op het oppervlakte en diamant.

- Hoge oppervlakte hardheid van de bladen (weerstand tegen het bot worden en slijtage)
- Laag coefficient van wrijving (gladde en anti kleef)
- Eccentrische borgpen
- Grote handgrepen met groeven voor het klemmen van ronde delen
- Met beweegbare kunststof houder



L	L1	S	€		
mm	mm	mm ²			
150	50	50	40,50	5	011280088

1128BMX

Electricienschaar, rechte roestvast stalen bladen met micro vertanding



L	L1	€		
mm	mm			
147	58,2	21,30	5	011280051

1128BMX/F

Beweegbare kunststof houder voor artikel 1128BMX



	€		
1128BMX/F	2,02	1	011280059

1128FXS ELEKTRICIENSCHAAR MET TRAPSGEWIJZE RUIMER

Om de schaar van onze elektriciens opnieuw te ontwerpen, observeerden we het dagelijkse werk van gebruikers. We hebben er een universele hulpmiddel van gemaakt, waarbij de 4 belangrijkste kenmerken in één product zijn verwerkt.

KNIPPEN Snel en scherp, voor kabels tot 50 mm², met een draadstrip uitsparing en voorzien van microvertanding, voor een betere grip.

STRIPPEN Mede door de instelbare scharnierschroef kunnen zelfs de dunste kabels nauwkeurig kunnen worden gestript.

KRIMPEN Veilig en duurzaam, voor kabelschoenen.

VERZINKEN Door het freesprofiel kunnen de gaten in trekdozen nauwkeurig en netjes op maat gemaakt worden.



1128BAX DUBBELWERKENDE ELEKTRICIENSCHAAR MET RUIMERS VAN DLC-GECOAT ROESTVRIJ STAAL

Schaar 1128BAX valt op door de met DLC afgewerkte bladen. DLC (diamond-like carbon) is een innovatieve coating op koolstofbasis: de hoge hardheid en lage wrijvingscoëfficiënt ontstaan door de gelijktijdige aanwezigheid van koolstof op het oppervlak in de vorm van grafiet en diamant.

- Hoge hardheid van het bladoppervlak - weerstand tegen schuren en slijtage
- Lage wrijvingscoëfficiënt - gladheid en anti-kleef

Dubbelwerkend snijden: ontworpen om gaten in kunststof te vergroten, van 13 mm tot 25 mm.



+ HARDHEID
- WRIJVINGSCOËFFICIËNT



1128BSX

Electricienschaar met trapsgewijze ruimer in etui



L mm	L1 mm	€	Stuks	Artikelnummer
148	58,2	36,00	5	011280061

1128FX

Electricienschaar, rechte roestvast stalen bladen, met microvertanding, draadstrip uitsparing en krimpgedeelte voor flexibele buizen

- Bewegbare houder met riemklem
- Twee componenten handgreep
- Veiligheidspin



L mm	L1 mm	mm ²	€	Stuks	Artikelnummer
145	52	50	39,50	5	011280090

1128FXS

Electricienschaar met trapsgewijze ruimer, rechte roestvasten bladen, met microvertanding, draadstrip uitsparing en krimpgedeelte voor flexibele buizen

- Bewegbare houder met riemklem
- Twee componenten handgreep
- Veiligheidspin

• Het profiel en ruimers: ontworpen om gaten in kunststof te vergroten, van 13 tot 21 mm.



L mm	L1 mm	mm ²	€	Stuks	Artikelnummer
145	52	50	45,50	5	011280095

1128BM

Electricienschaar, rechte bladen



L mm	L1 mm	€	Stuks	Artikelnummer
145	50	19,10	5	011280000

1129BM

Electricienschaar, gebogen bladen



L mm	L1 mm	€	Stuks	Artikelnummer
145	44	20,90	5	011290000

1130BMX

Universele schaar, rechte roestvast stalen bladen, met microvertanding



L mm	L1 mm	€	Stuks	Artikelnummer
185	60	23,10	1	011300002

1131CK

Kevlar® glasvezel scharen



L mm	L1 mm	€	Stuks	Artikelnummer
203	75	94,50	1	011310001

1132

Kabelscharen verchromd
Dubbele PVC handgreep



UNI 8791

L	mm	mm ²	€	1	011320107
170	14	50	55,50	2	011320107
230	18	95	68,50	2	011320113

1132BM

Kabelscharen verchromd
twee componenten handgreep



UNI 8791

L	mm	mm ²	€	1	011320137
170	14	50	68,50	2	011320137
230	18	95	84,50	2	011320143

1133

Kabelkniptang voor koperen kabels, flexibel

tot 325 mm²



L	mm	mm ²	€	1	011330001
600	30	325	195,50	1	011330001

1133RL

Reserve messen voor item 1133



1133RL	€	1	011330011
	146,50	1	011330011

1134

Kabelschaar met ratelmechanisme



L	mm	mm ²	€	1	011340032
260	35	400	561,00	1	011340032

1134RL

Reserve mes voor model 1134



1134RL	€	1	011340132
	264,00	1	011340132

1134A

Kabelschaar met ratelmechanisme



L	mm	mm ²	€	1	011340045
240	45	500	879,00	1	011340045

1142BM

Draadstriptang
twee componenten handgreep



UNI 7923

L	mm	mm ²	mm	€	3	011420036
160	0,5÷6	0-2,8		45,00	3	011420036

1143

Striptang met knipmechanisme



L	mm	mm ²	mm	€	1	011430001
165	0,5÷6	1-3,2		92,00	1	011430001

1143R

Reserve messen voor artikel 1143

1143R	€	1	011430011
	22,50	1	011430011

1144D

Draadstriptang



L	mm	mm ²	mm	€	1	011440010
170	4,5÷240	2,5-18		106,50	1	011440010

1144D/RG

Reserve haak voor 1144D



1144D/RG	€	1	011440012
	35,50	1	011440012

1144D/RL

Reserve messen voor 1144D

1144D/RL	€	1	011440011
	55,50	1	011440011

1144G

Kabelstriptang

met instelbaar mes voor lengte en overdwars snijden



L	mm	mm ²	mm	€	1	011440004
140	6÷75	2,8-12		59,50	1	011440004



Beta

1144G/RL

Reserve snijmes voor artikel 1144G



1144G/RL	€ 13,30	1	011440005
----------	---------	---	-----------

1144L

Kabelstriptang met instelbare mes voor lengte en overdwars snijden

Met een glad en haakvormig intrekbaar mes



L mm	mm ²	mm	€		
145	6-150	4-28	34,50	1	011440050

1144T

kabelstriptang, zakformaat, met snij-inrichting



L mm	mm	g	€		
112	3,5 ÷ 9	40	24,90	1	011440060

1148A

Draadstriptang, zelfinstellend model, knipmechanisme

- ≠10 mm² (8 AWG) flexibele draad
- ≠1,5 mm² (16 AWG) stijve draad



L mm	mm ²	mm	€		
190	0,02-10	0-4	192,00	1	011480100

1148A/R

Reserve messen voor model 1148A



1148A/R	€ 82,50	1	011480100
---------	---------	---	-----------

Beta

1148B

Draadstriptang, zelfinstellend model, knipmechanisme



L mm	mm ²	mm	€		
190	4-16	2-5	225,50	1	011480200

1148B/R

Reserve messen voor model 1148B



1148B/R	€ 102,50	1	011480200
---------	----------	---	-----------

1148P

Draadstriptang, zelfinstellend met knipmechanisme



L mm	mm ²	mm	€		
165	0,2-6	0-3,5	57,00	1	011480300

1149F

Automatische draadstriptang met knipmogelijkheid, zelfinstellend



L mm	mm ²	€		
175	0,2 ÷ 6	19,90	1	011490010

1150

Combinatietangen hoog verchromd dubbele PVC handgreep

- De gedecentraliseerde pen vergroot het hefboomeffect en vermindert daardoor de inspanning, voor een krachtig snijvermogen.



ISO 5746

L mm	L1 mm	mm	€		
160	42	1,6	25,00	5	011500046
180	46	1,8	27,00	5	011500048
200	50	2,0	30,00	5	011500050
220	50	2,0	32,50	2	011500052

1150G

Zware combinatietangen, handgreep voorzien van dubbel gelaagde anti slip PVC, industriële afwerking

- Excellente kwaliteit/prijs verhouding
- De gedecentraliseerde pen vergroot het hefboomeffect en vermindert daardoor de inspanning, voor een krachtig snijvermogen.



ISO 5746

L mm	L1 mm	mm	€		
160	42	1,6	24,00	5	011500066
180	46	1,8	26,00	5	011500068
200	50	2,0	28,00	5	011500070
220	50	2,0	30,50	2	011500072

Beta

1150HPC UNIVERSELE HYPERCUT TANG MET M2 GESINTERD STALEN SNIJVLAKKEN

- Het gedecentraliseerde scharnierpunt brengt het steunpunt dicht bij het snijpunt, waardoor het hefboomeffect wordt vergroot.
- De perfecte uitlijning van de bekken en het dunne profiel zorgen voor een veilige grip, zelfs in zeer krappe ruimtes.
- Het klauwhuis maakt gebruik van betrouwbaar, thermisch bewerkt molybdeenstaal om flexibel en duurzaam te zijn en om voor een veilige grip onder alle omstandigheden te zorgen

Statische test afschuifkracht = **-73%**

Gemiddelde levensduur van de snijvlakken = (test ISO 5744) **+127%**

Hardheid van de snijvlakken M2 = **65HRC**

**ABSOLUUT
BAANBREKEND**

**PAREL VERCHROOMDE
AFWERKING**

**OPMERKELIJKE
SNIJCAPACITEIT**

1150HPC

Combinatietang met geïntegreerde snijvlakken en gedecentraliseerd scharnierpunt. Voor zware toepassingen. Satijn verchroomde afwerking twee componenten handgreep

Geïntegreerd snijvlak
staal: M2
Dikte: 0.20 mm
Hoek: 62°
Hardheid: 63-65 HRC



PATENTED

ISO 5746

L mm	L1 mm	≠ mm	€	U	U
180	42	1,8	67,50	2	011500618

1150BM

Combinatietangen hoog verchroomd twee componenten handgreep

- De gedecentraliseerde pen vergroot het hefboomeffect en vermindert daardoor de inspanning, voor een krachtig snijvermogen.



ISO 5746

L mm	L1 mm	≠ mm	€	U	U
160	42	1,6	31,00	3	011500146
180	46	1,8	34,50	3	011500148
200	50	2,0	37,50	3	011500150
220	50	2,0	40,50	2	011500152

1150GBM

Zware combinatietangen, twee componenten handgreep, industriële afwerking

- Excellente kwaliteit/prijs verhouding
- De gedecentraliseerde pen vergroot het hefboomeffect en vermindert daardoor de inspanning, voor een krachtig snijvermogen.



ISO 5746

L mm	L1 mm	≠ mm	€	U	U
160	42	1,6	29,00	3	011500266
180	39	1,8	31,50	3	011500268
200	50	2,0	35,00	3	011500270
220	50	2,0	37,00	2	011500272

1153

Verstelbare tangen, twee posities verchroomd PVC handgreep



UNI ISO 9343

L mm	L1 mm	€	U	U
200	34	27,50	2	011530120

1162

Telefoontang, lange platte gegroefde bekken, verchroomd, handgreep bestendig tegen slippen door een dubbele PVC laag



ISO 5745

L mm	L1 mm	≠ mm	€	U	U
160	58	1,6	30,00	5	011620006
200	86	1,6	35,00	5	011620010



1162G

Telefoontangen, lange platte gegroefde beken,
handgreep voorzien van dubbel gelaagde anti slijp PVC,
industriële afwerking

• Excellente kwaliteit/prijs verhouding



ISO 5745

L mm	L1 mm	mm	€	Hand	Computer
160	58	1,6	24,20	5	011620066
200	86	1,6	27,50	5	011620070

1162BM

Telefoontang, lange platte gegroefde beken,
verchroomd,
twee componenten handgreep



ISO 5745

L mm	L1 mm	mm	€	Hand	Computer
160	58	1,6	36,50	3	011620036
200	86	1,6	41,50	3	011620040

1162GBM

Telefoontangen, lange platte gegroefde beken,
twee componenten handgreep,
industriële afwerking

• Excellente kwaliteit/prijs verhouding



ISO 5745

L mm	L1 mm	mm	€	Hand	Computer
160	58	1,6	30,50	3	011620266
200	86	1,6	35,50	3	011620270

1164

Telefoontang, lange platte gebogen beken,
verchroomd, dubbele PVC handgreep



ISO 5745

L mm	L1 mm	mm	€	Hand	Computer
160	54	1,6	32,00	5	011640006
200	76	1,6	36,50	5	011640010

1164BM

Telefoontangen
lange platte gebogen beken
verchroomd, twee componenten handgreep



ISO 5745

L mm	L1 mm	mm	€	Hand	Computer
160	54	1,6	39,00	3	011640036
200	76	1,6	43,50	3	011640040

1166

Telefoontang, lange halfronde gegroefde beken,
verchroomd,
handgreep bestendig tegen slippen door een dubbele PVC laag



ISO 5745

L mm	L1 mm	mm	€	Hand	Computer
160	56	1,6	30,00	5	011660006
200	76	1,6	35,00	5	011660010

1166G

Telefoontangen, extra lange halfronde gegroefde beken,
handgreep voorzien van dubbel gelaagde anti slijp PVC,
industriële afwerking

• Excellente kwaliteit/prijs verhouding

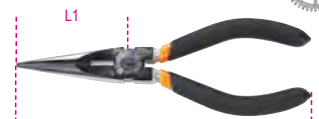

ISO 5745

L mm	L1 mm	mm	€	Hand	Computer
160	56	1,6	24,20	5	011660066
200	76	1,6	27,50	5	011660070

1166BM

Telefoontang, lange halfronde gegroefde beken,
verchroomd,
twee componenten handgreep



ISO 5745

L mm	L1 mm	mm	€	Hand	Computer
160	56	1,6	36,50	3	011660036
200	76	1,6	41,50	3	011660040

1166GBM

Telefoontangen, extra lange halfronde gegroefde beken,
twee componenten handgreep,
industriële afwerking

• Excellente kwaliteit/prijs verhouding



ISO 5745

L mm	L1 mm	mm	€	Hand	Computer
160	56	1,6	30,50	3	011660266
200	76	1,6	35,50	3	011660270

1168

Telefoontang, lange halfronde gebogen beken,
verchroomd,
handgreep bestendig tegen slippen door een dubbele PVC laag



ISO 5745

L mm	L1 mm	mm	€	Hand	Computer
160	54	1,6	32,00	5	011680006
200	76	1,6	36,50	5	011680010

1168G

Telefoontangen, lange gebogen halfronde beken,
handgreep voorzien van dubbel gelaagde anti slijp PVC,
industriële afwerking

• Excellente kwaliteit/prijs verhouding



ISO 5745

L mm	L1 mm	mm	€	Hand	Computer
160	54	1,6	26,50	5	011680066
200	76	1,6	31,00	5	011680070

1168BM

Telefoontang, lange halfronde gebogen bekken, verchromd, twee componenten handgreep



ISO 5745

L mm	L1 mm	mm	€	U	L
160	54	1,6	39,00	3	011680036
200	70	1,6	43,50	3	011680040

1168GBM

Telefoontangen, lange halfronde gebogen bekken, twee componenten handgreep, industriële afwerking

• Excellente kwaliteit/prijs verhouding



INDUSTRIAL FINISHING

ISO 5745

L mm	L1 mm	mm	€	U	L
160	54	1,6	34,00	3	011680266
200	70	1,6	38,00	3	011680270

1169/D3

3-delig tangenset; 1 combinatietang, 1 telefoontang met halfronde lange bekken en diagonale zijknijptang



1169/D3	€	U	L
1082 160mm 1150 180mm 1166 160mm	89,00	1	011690053

1169G/D3

Tangenset bestaande uit een combinatietang, een lange punttang en een zijknijptang. Handgreep voorzien van dubbele antislip PVC laag, industriële afwerking

• Excellente kwaliteit/prijs verhouding



INDUSTRIAL FINISHING

1169G/D3	€	U	L
1082G 160mm 1150G 180mm 1166G 160mm	77,50	1	011690073

1169BM/D3

3-delig tangenset; 1 combinatietang, 1 telefoontang met halfronde lange bekken en diagonale zijknijptang
Handgreep uit twee componenten materiaal



1169BM/D3	€	U	L
1082BM 160mm 1150BM 180mm 1166BM 160mm	112,50	1	011690133

1169GBM/D3

Tangenset bestaande uit een combinatietang, een lange punttang en een zijknijptang. Twee componenten handgreep, industriële afwerking

• Excellente kwaliteit/prijs verhouding



INDUSTRIAL FINISHING

1169GBM/D3	€	U	L
1082GBM 160mm 1150GBM 180mm 1166GBM 160mm	99,50	1	011690273

1169N/D4

4-delig Set tangen, bestaande uit; 1 zware combinatietang, 1 telefoontang met lange bekken, 1 zijknijptang en 1 waterpomptang, gefosforiseerd.



1169N/D4	€	U	L
1082 160 mm 1150 180 mm 1166 160 mm 1048N 250 mm	126,00	1	011690024

1171BM

Tang met korte gladde bekken. Twee componenten handgreep



ISO 9655

L	L1 mm	A mm	B mm	€	U	L
130	18	12	8	47,50	2	011710101

1172BM

Tang met lange gladde bekken. Twee componenten handgreep

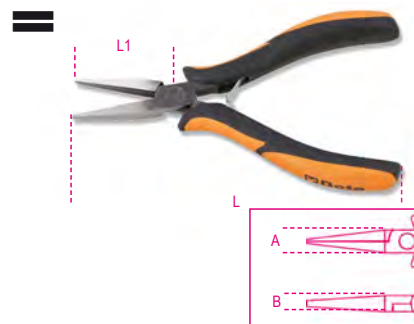

ISO 9655

L	L1 mm	A mm	B mm	€	U	L
140	40	12	8	47,50	2	011720101

Beta

1172BM/P

Tang met lange gladde gebogen bekken.
Twee componenten handgreep



L	L1	A	B	€	⚙️	📄
~ 140	mm 38	mm 12	mm 13	56,00	2	011720102

1173BM

Tang met ronde gladde bekken.
Twee componenten handgreep



L	L1	A	B	€	⚙️	📄
~ 125	mm 22	mm 12	mm 8	47,50	2	011730101

1175BM

Tang met halfronde gladde bekken.
Twee componenten handgreep



L	L1	A	B	€	⚙️	📄
~ 140	mm 29	mm 12	mm 8	47,50	2	011750101

1177BM

Tang met halfronde bekken.
Twee componenten handgreep

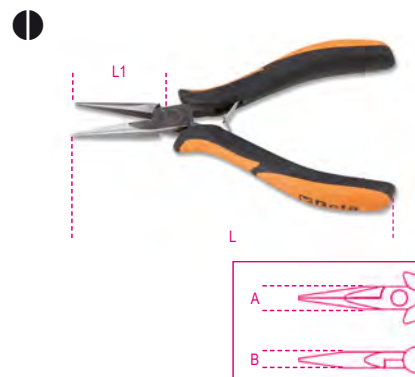

L	L1	A	B	€	⚙️	📄
~ 140	mm 38	mm 12	mm 8	47,50	2	011770101

1177BM/Z

Tang met halfronde lange gegroefde bekken.
Twee componenten handgreep



L	L1	A	B	€	⚙️	📄
~ 140	mm 39	mm 12	mm 8	56,00	2	011770113

1178BM

Tang met lange halfronde gladde bekken.
Twee componenten handgreep



L	L1	A	B	€	⚙️	📄
~ 140	mm 37	mm 12	mm 8	56,00	2	011780101

1178BM/P

Tang met lange gebogen gladde bekken.
Twee componenten handgreep



L	L1	A	B	€	⚙️	📄
~ 140	mm 36,5	mm 12	mm 12	56,00	2	011780102

Zijkniptang voor koper geleiders. Bijna vlakke snijvorm.
Voor zware toepassing zie artikel 1081

1182BM

Zijkniptang met dunne bekken en bijna vlakke snijvorm.
Twee componenten handgreep



L	L1	A	Cu	€	⚙️	📄
mm 120	mm 11	mm 10	mm 1	56,00	2	011820101



1183BM

Zijkniptang met afgeronde bekken en bijna vlakke snijvorm.
Twee componenten handgreep



ISO 9654

L mm	L1 mm	A mm	Cu mm	€	Handgreep	Art. no.
120	11	10	1	56,00	2	011830101
130	13	12,5	1,25	56,00	2	011830102

1184BM

Zijkniptang met afgeronde bekken en vlakke snijvorm.
Twee componenten handgreep



ISO 9654

L mm	L1 mm	A mm	Cu mm	€	Handgreep	Art. no.
120	11	10	1	56,00	2	011840101
130	13	12,5	1,25	56,00	2	011840102

1185BM

Zijkniptang met dunne bekken en vlakke snijvorm.
Twee componenten handgreep



ISO 9654

L mm	L1 mm	A mm	Cu mm	€	Handgreep	Art. no.
120	11	10	1	56,00	2	011850101
130	13	12,5	1,25	56,00	2	011850102

1186BM

Zijkniptang met puntige bekken en vlakke snijvorm.
Twee componenten handgreep



ISO 9654

L mm	L1 mm	A mm	Cu mm	€	Handgreep	Art. no.
120	11	10	1	56,00	2	011860101
130	13	12,5	1,25	56,00	2	011860102

1188BM

Zijkniptang met dunne bekken.
Twee componenten handgreep



ISO 9654

L mm	L1 mm	A mm	Cu mm	€	Handgreep	Art. no.
125	12	12	1,25	56,00	2	011880101
130	17	15	2	56,00	2	011880102

1190BM

Kopkniptang met bijna vlakke snijvorm.
Twee componenten handgreep



ISO 9654

L mm	L1 mm	A mm	Cu mm	€	Handgreep	Art. no.
120	12	12	1,25	56,00	2	011900113

1191BM

Kopkniptang vlakke snijvorm.
Twee componenten handgreep



ISO 9654

L mm	L1 mm	A mm	Cu mm	€	Handgreep	Art. no.
130	8	12	0,8	56,00	2	011910101

1191BM/L

Zijkniptang met dunne bekken en vlakke snijvorm.
Twee componenten handgreep



ISO 9654

L mm	L1 mm	A mm	Cu mm	€	Handgreep	Art. no.
130	18	12	1	56,00	2	011910110

1191R/5-M

Reserve veren voor tangen en kniptangen voor elektronica, 5 paar (art.: 1171...1191)

1191R/5-M	€	Handgreep	Art. no.
	10,80	1	011910995

1200MS

Magnetiseerder / demagnetiseerder

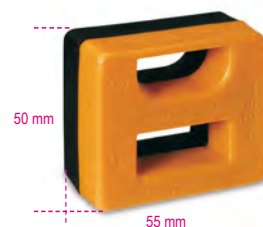

1200MS	€	Handgreep	Art. no.
	17,50	5	012000000

Beta **evox**

DE EVOLUTIE VAN DE SCHROEVENDRAAIER!

Het ergonomische ontwerp past perfect in de handpalm. Het grote contactoppervlak maakt het mogelijk om met minimale inspanning maximale kracht over te brengen. De beproefde en geteste bladen van Beta zorgen voor een unieke elasticiteit, hardheid en slijtvastheid voor professionele gereedschappen van topkwaliteit. De achthoekige vormgeving voorkomt hinderlijk rollen op het werkblad. Door het precisiegedeelte kan de schroevendraaier snel tussen de vingers worden gedraaid. Door het gloednieuwe gat in het handvat kan de schroevendraaier worden opgehangen voor eenvoudig opbergen. De stijl en de grootte van de punt zijn op de ronde deel van het handvat gedrukt voor snelle identificatie.



De stijl en de grootte van de punt zijn op de ronde deel van het handvat gedrukt voor snelle identificatie.

Het ergonomische ontwerp past perfect in de handpalm. Het grote contactoppervlak maakt het mogelijk om met minimale inspanning maximale kracht over te brengen.

De achthoekige vormgeving voorkomt hinderlijk rollen op het werkblad.

Door het gloednieuwe gat in het handvat kan de schroevendraaier worden opgehangen voor eenvoudig opbergen.



De stijl en de grootte van de punt zijn op de ronde deel van het handvat gedrukt voor snelle identificatie.

Door het precisiegedeelte kan de schroevendraaier snel tussen de vingers worden gedraaid.

1201E

Schroevendraaier voor sleufschroeven



ISO 2380

SxAxL mm	L1 mm	Ø mm	€		
0,4x2,5x50	146	2,5	4,25	5	012011003
0,4x2,5x75	166	2,5	4,45	5	012011006
0,5x3x75	171	3,0	4,50	5	012011009
0,5x3x100	196	3,0	4,90	5	012011012
0,6x3,5x75	171	3,5	5,05	5	012011018
0,6x3,5x100	196	3,5	5,05	5	012011021
0,8x4x100	196	4,0	5,20	5	012011030
0,8x4x125	221	4,0	5,25	5	012011033
0,8x4x150	246	4,0	5,75	5	012011036
1,0x5,5x100	209	5,0	6,35	5	012011039
1,0x5,5x125	234	5,0	6,55	5	012011040
1,0x5,5x150	259	5,0	6,70	5	012011042
1,2x6,5x100	220	6,0	7,40	5	012011048
1,2x6,5x125	234	6,0	7,65	5	012011050
1,2x6,5x150	270	6,0	7,95	5	012011051
1,2x8x150	282	8,0	10,30	3	012011057
1,2x8x200	332	8,0	11,00	3	012011060
1,6x10x200	332	9,5	12,50	3	012011066



1201E/S6

0,5x3x75-0,6x3,5x100
0,8x4x100-1,0x5,5x100
1,2x8x150-1,6x10x200 mm

€ 44,00 1 012011206

1201EN

Schroevendraaier voor sleufschroeven, extra-korte uitvoering



ISO 2380

SxAxL mm	L1 mm	Ø mm	€		
0,8x4x30	86,5	4	6,25	3	012011103
1,2x6,5x30	86,5	6	6,65	3	012011106

1201E/DZ

Schroevendraaier voor Dzus® schroeven



L mm	L1 mm	€	🔧	📦
53	173	15,20	2	012011501

1202E

Schroevendraaier voor Phillips® kruiskop schroeven



UNI-ISO 8764

PHxDxL mm	L1 mm	€	🔧	📦
0x3x60	156	4,40	5	012021003
0x3x100	200	4,90	5	012021006
1x4,5x80	189	5,65	5	012021009
1x4,5x120	229	6,40	5	012021012
2x6x100	220	7,65	5	012021018
2x6x150	270	8,30	5	012021021
3x8x150	282	10,60	3	012021024
4x9,5x200	332	13,60	3	012021027



PHxDxL mm	L1 mm	€	🔧	📦
1202E/S4 PH0x3x60-PH1x4,5x120 PH2x6x150-PH3x8x150 mm		29,50	1	012021204

1202EN

Schroevendraaier voor Phillips® kruiskop schroeven. Extra- korte uitvoering



UNI-ISO 8764

PHxDxL mm	L1 mm	€	🔧	📦
1x4,5x30	86,5	6,30	3	012021103
2x6x30	86,5	6,65	3	012021106

1202EL

Schroevendraaier voor Phillips® kruiskop schroeven, lange uitvoering



UNI-ISO 8764-1

PHxDxL mm	L1 mm	€	🔧	📦
0x3x300	400	7,95	3	012021303
1x4,5x300	400	8,70	3	012021305
1x4,5x400	508	10,60	3	012021306
2x6x400	519	12,20	3	012021309

1203E/D

Schroevendraaierset



PHxDxL mm	L1 mm	€	🔧	📦
1203E/D5 1201E 0,6x3,5x100-1,0x5,5x150 1,2x6,5x150 mm 1202E PH1x4,5x80-PH2x6x100 mm		33,00	1	012031001

PHxDxL mm	L1 mm	€	🔧	📦
1203E/D5PZ 1201E 0,5x3x75-0,8x4x125 1,0x5,5x150 mm 1209E/PZ PZ1x4,5x80-PZ2x6x100 mm		32,50	1	012031003

PHxDxL mm	L1 mm	€	🔧	📦
1203E/D6 1202E PH1x4,5x80-PH2x6x100 mm 1204E 0,4x2,5x60-0,5x3x100 0,8x4x100-1,0x5x125 mm		34,00	1	012031006

PHxDxL mm	L1 mm	€	🔧	📦
1203E/D7 1201E 0,5x3x75-0,8x4x100 1,0x5,5x100-1,2x6,5x150 mm 1202E PH0x3x60-PH1x4,5x80 PH2x6x100 mm		41,50	1	012031007

PHxDxL mm	L1 mm	€	🔧	📦
1203E/D8 1201E 0,5x3x75-0,8x4x125 1,0x5,5x150-1,2x6,5x150 mm 1202E PH0x3x60-PH1x4,5x80 PH2x6x100-PH3x8x150 mm		52,50	1	012031008

PHxDxL mm	L1 mm	€	🔧	📦
1203E/D8P 1201E 2,5x50-3x75-4x100 5,5x100-6,5x150 mm 1202E PH0x60-PH1x80-PH2x100 mm		46,00	1	012031018

PHxDxL mm	L1 mm	€	🔧	📦
1203E/D10 1201E 0,4x2,5x50-0,5x3x75 0,8x4x100-1,0x5,5x100 1,2x6,5x150-1,2x8x150 mm 1202E PH0x3x60-PH1x4,5x80 PH2x6x100-PH3x8x150 mm		67,00	1	012031010

PHxDxL mm	L1 mm	€	🔧	📦
1203E/D10N 1201E 0,4x2,5x50-0,5x3x75-0,8x4x100- 1,0x5,5x150-1,2x6,5x150 mm 1201EN 0,8x4x30 mm 1202E PH0x3x60 - PH1x4,5x80 - PH2x6x100 mm 1202EN PH1x4,5x30 mm		59,00	1	012031019

1203E/S



PHxDxL mm	L1 mm	€	🔧	📦
1203E/S8 1201E 2,5x50-3x75-4x100 5,5x125-6,5x150 mm 1202E PH0x3x60-PH1x4,5x80 PH2x6x100 mm		46,00	1	012031009

PHxDxL mm	L1 mm	€	🔧	📦
1203E/S10 1201E 0,4x2,5x50-0,5x3x75 0,8x4x125-1,0x5,5x150 1,2x6,5x150-1,2x8x150 mm 1202E PH0x3x60-PH1x4,5x80 PH2x6x100-PH3x8x150 mm		67,00	1	012031021

1204E

Schroevendraaier voor verzonken sleufschroeven, lange uitvoering



ISO 2380

SxDxL mm	L1 mm	€	🔧	📦
0,4x2,5x60	156	4,40	5	012041003
0,6x3x75	175	4,50	5	012041006
0,5x3x100	196	4,75	5	012041009
0,8x4x100	196	5,15	5	012041012
0,8x4x125	233	5,45	5	012041015
1x5x125	234	6,25	5	012041018
1x5x150	258	6,95	5	012041021
1,2x6,5x150	270	7,65	5	012041024



SxDxL mm	L1 mm	€	🔧	📦
1204E/S5 0,4x2,5x60-0,5x3x100 0,8x4x100-1x5x125 1,2x6,5x150 mm		28,00	1	012041205

1204EL

Schroevendraaier voor verzonken sleufschroeven, lange uitvoering



ISO 2380

SxDxL mm	L1 mm	€	📦	🚚	📄
0,5x2,5x200	300	6,40	3	012041303	
0,5x3x300	400	7,65	3	012041306	
0,8x4x400	508	9,65	3	012041309	
1x5x400	508	10,30	3	012041315	
1,2x6,5x400	519	12,90	3	012041318	

1205E/ES

Schroevendraaiers met binnenzeskant



mm	L mm	L1 mm	€	📦	🚚	📄
1,5	100	200	5,65	3	012051315	
2	100	200	5,65	3	012051320	
2,5	100	200	5,90	3	012051325	
3	100	200	6,15	3	012051330	
4	100	208	6,80	3	012051340	
5	100	219	8,35	3	012051350	
6	125	244	8,45	3	012051360	
8	150	277	11,20	2	012051380	



1205E/ES-S8	€	📦	🚚	📄
1,5-2-2,5-3-4-5-6-8 mm	58,00	1	012051408	

1206E/BP

Schroevendraaiers met kogelkop



mm	L mm	L1 mm	Ø mm	€	📦	🚚	📄
2	100	198	2,5	6,20	3	012061320	
2,5	100	198	3,0	6,35	3	012061325	
3	100	198	3,5	6,45	3	012061330	
4	100	209	5,0	7,25	3	012061340	
5	100	220	6,0	8,60	3	012061350	
6	125	245	7,0	9,00	3	012061360	
8	150	287	9,5	12,20	2	012061380	



1206E/BP-S7	€	📦	🚚	📄
2-2,5-3-4-5-6-8 mm	56,00	1	012061407	

1207E/TX

Schroevendraaiers voor Torx® schroeven



	L mm	L1 mm	Ø mm	€	📦	🚚	📄
T5	50	150	3	6,65	5	012071005	
T6	60	156	4	7,30	5	012071006	
T7	60	156	4	7,40	5	012071007	
T8	60	156	4	7,50	5	012071008	
T9	60	156	4	7,80	5	012071009	
T10	80	189	5	8,75	5	012071010	
T15	80	189	5	8,95	5	012071015	
T20	100	209	5	9,10	5	012071020	
T25	100	209	5	9,40	5	012071025	
T27	100	220	6	10,00	5	012071027	
T30	100	220	6	10,10	5	012071030	
T40	130	262	7	12,00	2	012071040	
T45	130	262	8	13,10	2	012071045	



1207E/TX-D7	€	📦	🚚	📄
T6-T8-T10-T15 T20-T25-T30	61,00	1	012071207	
1207E/TX-S13	€	📦	🚚	📄
T5-T6-T7-T8-T9-T10-T15 T20-T25-T27-T30-T40-T45	118,00	1	012071213	

1208E/RTX

Schroevendraaiers voor Tamper Resistant Torx® schroeven



	L mm	L1 mm	Ø mm	€	📦	🚚	📄
T9	60	156	4	7,90	5	012081009	
T10	80	189	5	8,85	5	012081010	
T15	80	189	5	9,40	5	012081015	
T20	100	209	5	9,55	5	012081020	
T25	100	209	5	9,75	5	012081025	
T27	100	220	6	10,50	5	012081027	
T30	100	220	6	11,00	5	012081030	
T40	130	262	7	13,00	2	012081040	



1208E/RTX-D7	€	📦	🚚	📄
T9-T10-T15-T20 T25-T27-T30	67,00	1	012081207	

1209E/PZ

Schroevendraaiers voor Pozidriv®-Supadriv® kruiskop schroeven



UNI-ISO 8764

PZ	L mm	L1 mm	€	📦	🚚	📄
0	60	156	5,40	5	012091000	
1	80	189	7,05	5	012091003	
2	100	220	8,85	5	012091006	
3	150	282	13,40	3	012091009	
4	200	327	15,10	3	012091012	



1209E/PZ-S4	€	📦	🚚	📄
PZ0-PZ1-PZ2-PZ3	34,50	1	012091204	

1209EN/PZ

Schroevendraaiers voor Pozidriv®-Supadriv® kruiskop schroeven, extra korte uitvoering



ISO 8764

PZ	L mm	L1 mm	€	📦	🚚	📄
1	30	87	6,30	3	012091103	
2	30	87	6,65	3	012091106	

Beta **EVOLX-E**

ELEKTRISCHE SCHROEVENDRAAIER BETA EVOLX-E

De elektrische schroevendraaier, Beta Evolx-E, is ideaal voor het uitvoeren van uiterst nauwkeurige klussen met minimale inspanning en maximale snelheid.



GEMAK

Kleinere afmetingen voor gebruik in kleine ruimtes, en LED's aan de voorkant voor uitstekend zicht op het werkpunt.

ERGONOMISCH ONTWERP

Het handvat past perfect in de handpalm, voor een stevige, comfortabele grip.

1/4



USB-C



Batterijduur

Duurzame 3,7 V 2300 mAh lithiumbatterij, die tot 1.000 schroefbevestigingen mogelijk maakt met één oplaadcyclus.

Het is verkrijgbaar in twee varianten:

- elektrische schroevendraaier 1210E/GE met bits



- elektrische schroevendraaier 1211E/GE met 1000V geïsoleerde bits



△ 1000 V



1210E/GE

Evox-E elektrische schroevendraaier



L
mm
150

€
164,00

1 012110701

1211E/GE

Evox-E elektrische schroevendraaier



L
mm
150

€
182,00

1 012110701



1229LP/A6

1,2-1,4-1,8-2-2,4-3 mm

€
25,00

1 012290300

1229LPH/A6

6-delig set micro schroevendraaiers van serie 1229LP en 1229PH

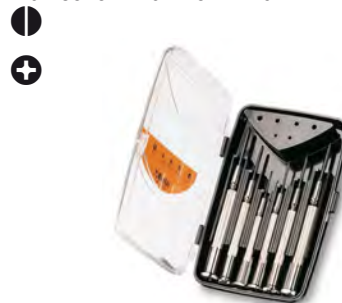

1229LPH/A6

1229LP 1,4-2,0-2,4-3 mm
1229PH PH0-PH1

€
25,00

1 012290310

1236B

Haakse schroevendraaiers
voor sleufschroeven

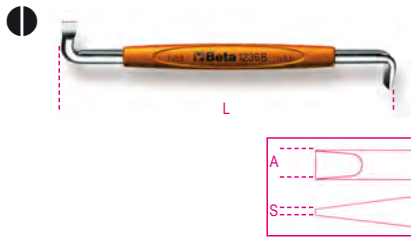

UNI 7079 DIN 5200

SxA	L	€		
mm	mm			
0,8x4	100	7,75	5	012360201
1x5,5	125	9,00	5	012360202
1,2x8	150	11,20	5	012360204

1238B

Haakse schroevendraaier
voor Phillips® kruiskopschroeven



UNI 7083 DIN 5208

PH	L	€		
	mm			
1-2	125	9,15	5	012380201
3-4	200	15,10	5	012380203

1241

Slagvaste schroevendraaiers
voor sleufschroeven



ISO 2380

SxAxL	L1	€		
mm	mm			
1x5,5x100	202	12,30	5	012410039
1,2x6,5x125	240	13,70	5	012410050
1,2x8x150	268	17,00	3	012410057
1,6x10x175	300	20,80	2	012410065
1,6x10x200	325	21,20	2	012410066
2,0x12x200	325	22,30	2	012410067
2,5x14x250	375	24,40	2	012410076

1242

Slagvaste schroevendraaier
voor Phillips® kruiskopschroeven



UNI/ISO 8764

PHxDxL	L1	€		
mm	mm			
1x4,5x100	202	12,20	5	012420209
2x6x100	215	14,50	5	012420218
3x8x150	268	18,30	3	012420221
4x11x200	325	23,80	2	012420224

1243LP/D6

set van 6 schroevendraaiers met stalen kop,
voor sleufschroeven



	€		
1243LP/D6	110,50	1	012430016
1241			
			1x5,5x100-1,2x6,5x125 3x8x150-1,6x10x175 2,0x12x200-2,5x14x250 mm

1243/D7

7-delig set slagvaste schroevendraaiers



	€		
1243/D7	109,00	1	012430017
1241			1x5,5x100-1,2x6,5x125 1,2x8x150-1,6x10x200 mm
1242			PH1x4,5x100-PH2x6x100 PH3x8x150 mm

1243/S11

set van 11 schroevendraaiers met stalen kop



	€		
1243/S11	200,50	1	012430021
1241			1x5,5x100-1,2x6,5x125 3x8x150-1,6x10x175 1,6x10x200-2,0x12x200 2,5x14x250 mm
1242			PH1x4,5x100-PH2x6x100 PH3x8x150-PH4x11x200 mm

1250

Klemschroeven-draaiers
voor sleufschroeven

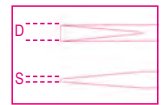

SxDxL	L1	€		
mm	mm			
0,5x3x125	190	17,80	5	012500030
0,6x4x125	225	19,60	5	012500040
0,7x5x150	255	22,30	5	012500050

1251

Klemschroeven-draaiers
voor Phillips® kruiskopschroeven



PHxDxL	L1	€		
mm	mm			
0x4x125	225	20,20	5	012510000
1x5x125	225	23,10	5	012510010
2x6x175	280	26,50	5	012510020

1252/S5



	€		
1252/S5	109,50	1	012520001
1250			0,5x3x125-0,6x4x125 0,7x5x150 mm
1251			PH1x5x150-PH2x6x175 mm



1253

Spanningszoeker 150/250V

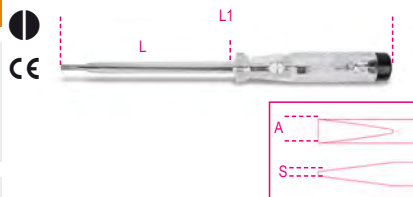

SxAxL mm	L1 mm	€	5	012530001
0,5x3,5x100	190	10,60		

1253A

Spanningszoeker 125/250V, dubbel geïsoleerd

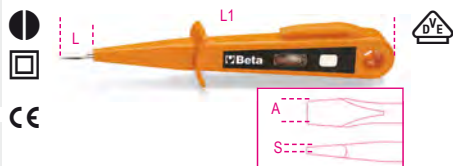

SxAxL mm	L1 mm	€	5	012530010
0,5x3x15	150	7,80		

1254

Spanningszoeker 6/24V

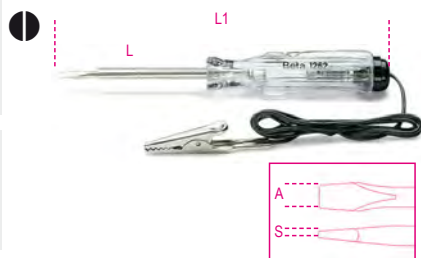

SxAxL mm	L1 mm	€	5	012540001
0,5x3x44	123	11,50		

1256/C36-2

Microschroevendraaier met 36 verwisselbare 4-mm bits en magnetisch verlengstuk



1256/C36-2	€	1	012560100
	77,50		

	1256TX	T3 - T4 - T5 - T6 - T7 T8 - T9 - T10 - T15
	1256RTX	T6 - T7 - T8 - T9 - T10
	1256LP	0,8 - 1,2 - 1,5 - 1,8 - 2 - 2,5 3 - 3,5 - 4 mm
	1256PE	0,7 - 0,9 - 1,3 - 1,5 - 2 mm
	1256PH	PH000 - PH00 - PH0 - PH1
	1256PZ	PZ000 - PZ00 - PZ0 - PZ1
	1256/20	
	1256/30	

130x60x35 mm - 200 g

1256LP

4-mm bits voor sleufschroeven

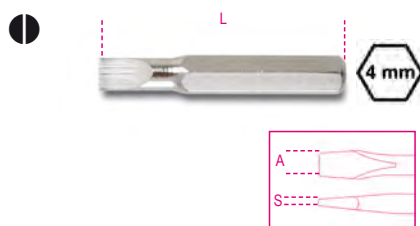

SxA mm	L mm	€	5	012560001
0,25x0,8	27	1,47		
0,25x1,2	27	1,47		
0,3x1,5	27	1,47		
0,35x1,8	27	1,47		
0,4x2,0	27	1,47		
0,4x2,5	27	1,47		
0,5x3,0	27	1,47		
0,6x3,5	27	1,47		
0,8x4,0	27	1,47		

1256PH

4-mm bits voor kruiskopschroeven met Phillips® profiel



PH	L mm	€	5	012560011
000	27	1,47		
00	27	1,47		
0	27	1,47		
1	27	1,47		

1256PZ

4-mm bits for slotted head Pozidriv® - Supradriv® screws



PZ	L mm	€	5	012560061
000	27	1,47		
00	27	1,47		
0	27	1,47		
1	27	1,47		

1256PE

4-mm bits voor schroeven met binnenzeskant profiel



mm	L mm	€	5	012560021
0,7	27	1,49		
0,9	27	1,49		
1,3	27	1,49		
1,5	27	1,49		
2,0	27	1,49		

1256TX

4-mm bits voor schroeven met Torx® profiel



T	L mm	€	5	012560041
T3	27	1,60		
T4	27	1,60		
T5	27	1,60		
T6	27	1,60		
T7	27	1,60		
T8	27	1,60		
T9	27	1,60		
T10	27	1,60		
T15	27	1,60		

1256RTX

4-mm bits voor schroeven met Tamper Resistant Torx® profiel



T	L mm	€	5	012560051
T6	27	1,92		
T7	27	1,92		
T8	27	1,92		
T9	27	1,92		
T10	27	1,92		

1256/20

Zeskant lange bithouder, 4 mm



1256/20	€	5	012560092
	8,90		

1256/30

4-mm bithouder met handgreep



L mm	€	2	012560097
110	10,80		

1257LP

Micro-schroevendraaiers voor sleufschroeven



SxD mm	L mm	€	5	012570012
0,25x1,2	60	5,85		
0,23x1,5	60	5,85		
0,3x1,8	60	5,85		
0,4x2	60	5,85		
0,4x2,5	60	5,85		

SxD mm	L mm	€	🔧	📦
0,5x3	60	5,85	5	012570030
0,6x3,5	60	5,85	5	012570035
0,8x4	60	5,85	5	012570040



1257LP/S8	€	🔧	📦
0,2x1,2-0,25x1,5 0,3x1,8-0,4x2-0,4x2,5 0,5x3-0,6x3,5-0,8x4 mm	73,50	1	012570200

1257PH

Micro-schroevendraaiers
voor Phillips® kruiskopschroeven



PH	L mm	€	🔧	📦
00	60	5,85	5	012570060
0	60	5,85	5	012570063
1	60	5,85	5	012570066

1257LPH/S8



1257LPH/S8	€	🔧	📦
1257PH PH00-PH0-PH1 1257LP 0,4x2-0,4x2,5-0,5x3 0,6x3,5-0,8x4 mm	73,50	1	012570210

1257ES

Micro-schroevendraaiers
voor binnenzeskant schroeven



mm	L mm	€	🔧	📦
0,9	60	6,55	5	012570045
1,3	60	6,55	5	012570046
1,5	60	6,55	5	012570047
2	60	6,55	5	012570048
2,5	60	6,55	5	012570049
3	60	6,55	5	012570050

1257ESB/S8



1257ESB/S8	€	🔧	📦
1257ES 0,9-1,3-1,5-2-2,5-3 mm 1257BE 4-5 mm	83,50	1	012570230

1257TX

Micro-schroevendraaiers
voor Torx® schroeven



T	L mm	€	🔧	📦
T5	60	6,80	5	012570075
T6	60	6,80	5	012570076
T7	60	6,80	5	012570077
T8	60	6,80	5	012570078
T9	60	6,80	5	012570079
T10	60	6,80	5	012570080
T15	60	6,80	5	012570081
T20	60	6,80	5	012570082



1257TX/S8	€	🔧	📦
T5-T6-T7-T8 T9-T10-T15-T20	81,00	1	012570220

1257BE

Micro-schroevendraaiers
voor zeskant schroeven



mm	L mm	€	🔧	📦
3,2	60	8,95	5	012570085
4	60	8,95	5	012570086
5	60	8,95	5	012570087
5,5	60	8,95	5	012570088

De BetaGrip-schroevendraaiers zijn het resultaat van Beta's jarenlange expertise op het gebied van schroevendraaierontwerp en nauwe samenwerking met de monteurs van autosportteams. Er zijn nieuwe, unieke technische oplossingen gebruikt die aan de meest veeleisende eisen van professionals kunnen voldoen, met het oog op het bereiken van de hoogste normen op het gebied van ergonomie, sterkte en kwaliteit van de materialen.

- Het blad is gemaakt van speciaal staal met een hoog gehalte aan silicium, chroom en vanadium, voor betere prestaties op het gebied van torsie- en buigsterkte. Er is gekozen voor een niet-verblindende, mat verchromde afwerking.
- De geometrie van de punt is ontworpen om een perfecte passing tussen het blad en de schroefkop te garanderen. De met fosfaat gecoate afwerking voorkomt dat de punt oxideert, terwijl de precieze profielen behouden blijven.
- De textuur is geïnspireerd op het profiel van racebanden, ontwikkeld om de grip op verschillende ondergronden te maximaliseren. Daarom zorgt het voor een effectieve grip van de schroevendraaier onder alle werkomstandigheden, voor meer precisie en controle bij het aanbrengen van de punt op de schroef.



1260

Schroevendraaiers voor sleufschroeven



ISO 2380

SxAxL mm	L1 mm	Ø mm	€	U	IP
0,4x2,5x50	150	2,5	5,85	5	012600003
0,4x2,5x75	175	2,5	6,10	5	012600006
0,5x3x75	175	3,0	6,45	5	012600009
0,5x3x100	200	3,0	6,55	5	012600012
0,6x3,5x75	175	3,5	6,65	5	012600018
0,6x3,5x100	200	3,5	6,75	5	012600021
0,8x4x100	208	4,0	7,50	5	012600030
0,8x4x125	233	4,0	7,90	5	012600033
0,8x4x150	258	4,0	8,35	5	012600036
1x5,5x100	208	5,0	8,45	5	012600039
1x5,5x125	233	5,0	8,80	5	012600040
1x5,5x150	258	5,0	9,45	5	012600042
1,2x6,5x100	219	6,0	10,10	5	012600048
1,2x6,5x125	244	6,0	10,50	5	012600050
1,2x6,5x150	269	6,0	10,80	5	012600051
1,2x8x150	277	8,0	13,40	3	012600057
1,2x8x200	327	8,0	14,10	3	012600060
1,6x10x200	327	9,5	16,90	3	012600066
2x12x250	377	10	20,10	3	012600069
2x14x250	377	10	21,30	2	012600073



1260/S6	€	U	IP
0,4x2,5x75-0,5x3x75-0,8x4x125 1x5,5x150-1,2x6,5x150-1,2x8x200 mm	55,00	1	012600306

1260N

Schroevendraaiers voor sleufschroeven
korte uitvoering



ISO 2380

SxAxL mm	L1 mm	Ø mm	€	U	IP
0,8x4x30	87	4	7,75	5	012600103
1,2x6,5x30	87	6	8,55	5	012600106

1260E

Schroevendraaiers voor sleufschroeven met zeskant



ISO 2380

SxAxL mm	L1 mm	Ø mm	€		
1,2x6,5x150	269	6,0	14,30	3	012600156
1,2x8x175	301	8,0	17,60	3	012600157
1,6x10x200	327	9,5	20,40	2	012600159
2x12x250	377	9,5	23,70	2	012600162

1260MC

schroevendraaier voor sleufschroeven, gekleurd



SxAxL mm	L1 mm	Ø mm	€		
0,4x2,5x50	150	2,5	6,45	3	012602003
0,6x3,5x75	175	3,5	6,65	3	012602018
0,8x4x100	208	4,0	8,25	3	012602030
1x5,5x150	233	5,0	10,00	5	012602040
1,2x6,5x150	269	6,0	11,40	5	012602051

1262

Schroevendraaiers voor Phillips® kruiskop schroeven



UNI/ISO 8764

PHxDxL mm	L1 mm	€		
0x3x60	160	6,45	5	012620003
0x3x100	200	6,85	5	012620006
1x4,5x80	188	8,35	5	012620009
1x4,5x120	228	9,20	5	012620012
2x6x100	219	10,30	5	012620018
2x6x150	269	11,20	5	012620021
3x8x150	277	14,80	3	012620024
4x10x200	327	18,70	3	012620027



1262/S4	€		
PH0x3x60-PH1x4,5x80 PH2x6x100-PH3x8x150 mm	40,00	1	012620304

1262N

Schroevendraaiers voor Phillips® kruiskop schroeven, korte uitvoering



UNI/ISO 8764

PHxDxL mm	L1 mm	€		
1x4,5x30	87	7,75	5	012620103
2x6x30	87	8,55	5	012620106

1262E

Schroevendraaiers voor Phillips® kruiskop schroeven met zeskant



UNI/ISO 8764

PHxDxL mm	L1 mm	€		
2x6x150	269	14,10	3	012620153
3x8x175	302	17,20	3	012620156
4x10x200	327	22,30	2	012620159

1262L

Schroevendraaiers voor Phillips® kruiskop schroeven, lange uitvoering



UNI/ISO 8764-1

PHxDxL mm	L1 mm	€		
0x3x300	400	11,00	3	012620203
1x4,5x300	400	13,10	3	012620205
1x4,5x400	508	15,50	3	012620206
2x6x400	519	19,60	3	012620209

1262MC

schroevendraaier voor kruiskop Phillips® schroeven, gekleurd



PHxDxL mm	L1 mm	€		
0x3x60	160	6,75	3	012622003
1x4,5x80	188	8,55	3	012622009
2x6x100	219	10,50	3	012622018

1263/D...

Schroevendraaierset



1263/D6	€		
1260 0,5x3x75-0,8x4x100 1x5,5x125-1,2x6,5x150 mm 1262 PH1x4,5x80-PH2x6x100 mm	52,00	1	012630006



1263/D7	€		
1262 PH0x3x60 PH1x4,5x80 PH2x6x100 mm 1264 0,5x2,5x60-0,6x3x100 0,8x4x125-1x5x125 mm	54,50	1	012630017



1263/D7PZ	€		
1260 0,5x3x75-0,8x4x100 1x5,5x150-1,2x6,5x150 mm 1269PZ PZ0 - PZ1 - PZ2	62,50	1	012630007



1263/D8	€		
1260 0,4x2,5x50-0,5x3x75 0,8x4x100-1x5,5x125 1,2x6,5x150 mm 1262 PH0x3x60-PH1x4,5x80 PH2x6x100 mm	64,50	1	012630008



1263/D10	€		
1260 0,5x3x75-0,6x3,5x100 0,8x4x125-1x5,5x150 1,2x6,5x150 mm 1260N 0,8x4x30 1262 PH0x3x60-PH1x4,5x80 PH2x6x100 mm 1262N PH1x4,5x30	82,00	1	012630010

1263/S12

12-delig set schroevendraaier



1263/S12 € 117,50 1 012630112

1260	0,4x2,5x50-0,5x3x75 0,6x3,5x100-0,8x4x125 1x5,5x125-1,2x6,5x150 1,2x8x200-1,6x10x200 mm
1262	PH0x3x60-PH1x4,5x80 PH2x6x100-PH3x8x150 mm

1263MC/D8

8-delig set schroevendraaiers, gekleurd



1263MC/D8 € 68,50 1 012632008

1260MC	0,4x2,5x50-0,5x3x75 0,8x4x100-1x5,5x125 1,2x6,5x150 mm
1262MC	PH0x3x60-PH1x4,5x80 PH2x6x100 mm

1264

Schroevendraaiers voor verzonken sleufschroeven

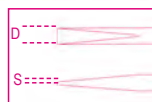

SxDxL mm	L1 mm	€		
0,5x2,5x60	160	6,25	5	012640003
0,6x3x75	175	6,70	5	012640006
0,6x3x100	200	6,80	5	012640009
0,8x4x100	208	7,65	5	012640012
0,8x4x125	233	7,90	5	012640015
1x5x125	233	8,70	5	012640018
1x5x150	258	9,40	5	012640021
1,2x6,5x150	269	11,20	5	012640024



1264/S5 € 40,50 1 012640305

0,5x2,5x60-0,6x3x75 0,8x4x100-1x5x125-1,2x6,5x150 mm

1264L

Schroevendraaiers voor verzonken sleufschroeven, lange uitvoering

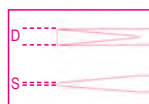

SxDxL mm	L1 mm	€		
0,5x2,5x200	300	8,90	3	012640203
0,6x3x300	400	10,30	3	012640206
0,8x4x400	508	13,30	3	012640209
1x5x400	508	14,90	3	012640215
1,2x6,5x400	519	18,10	3	012640218

1265ES

Schroevendraaier met binnenzeskant



mm	L mm	L1 mm	€		
1,5	100	200	7,35	3	012650015
2	100	200	7,55	3	012650020
2,5	100	200	7,75	3	012650025
3	100	200	8,10	3	012650030
4	100	208	9,25	3	012650040
5	100	219	10,50	3	012650050
6	125	244	11,40	3	012650060
8	150	277	16,00	2	012650080



1265ES/S8 € 78,00 1 012650308

1,5-2-2,5-3-4-5-6-8 mm

1266BP

Schroevendraaier met kogelkop



mm	L mm	L1 mm	€		
2	100	200	7,85	3	012660020
2,5	100	200	8,30	3	012660025
3	125	225	8,85	3	012660030
4	125	233	10,00	3	012660040
5	120	239	11,20	3	012660050
6	140	259	12,90	3	012660060
8	160	287	16,40	2	012660080
10	160	287	19,80	2	012660100



1266BP/S8 € 95,50 1 012660308

2-2,5-3-4-5-6-8-10 mm

1267TX

Schroevendraaier voor schroeven met Torx® profiel



Ø	L mm	L1 mm	Ø mm	€		
T5	50	150	3	8,90	5	012670005
T6	50	150	3	9,10	5	012670006
T7	50	150	3	9,60	5	012670007
T8	60	160	3	10,00	5	012670008
T9	60	167	4	10,80	5	012670009
T10	80	188	4	10,90	5	012670010
T15	80	188	4	11,50	5	012670015
T20	100	208	4,5	12,20	5	012670020
T25	100	208	5	12,80	5	012670025
T27	115	234	6	14,10	5	012670027
T30	115	234	6	14,70	5	012670030
T40	130	257	7	16,90	2	012670040
T45	130	257	8	17,90	2	012670045



1267TX/D7
T6-T8-T10-T15
T20-T25-T30

€ 81,00 1 012670307



1267TX/S13
T5-T6-T7-T8-T9
T10-T15-T20-T25
T27-T30-T40-T45

€ 159,50 1 012670312

1267MC/TX

schroevendraaiers voor schroeven met Torx®, met handgrepen, gekleurd



Ø	L mm	L1 mm	Ø mm	€	U	PC
T6	50	150	3	9,70	5	012672006
T8	60	160	3	10,20	5	012672008
T10	80	188	4	11,20	5	012672010
T15	80	188	4	11,80	5	012672015
T20	100	208	4,5	12,70	5	012672020
T25	100	208	5	13,30	3	012672025
T30	115	234	6	14,70	3	012672030



1267MC/TX-D7
T6-T8-T10-T15
T20-T25-T30

€ 83,50 1 012672307

1268RTX

Schroevendraaier voor schroeven met Tamper Resistant Torx® profiel



Ø	L mm	L1 mm	Ø mm	€	U	PC
T9	60	167	4,0	11,50	3	012680009
T10	80	188	4,0	12,00	3	012680010
T15	80	188	4,0	12,30	3	012680015
T20	100	208	4,5	12,90	3	012680020
T25	100	208	5,0	13,40	3	012680025
T27	115	234	6,0	14,90	3	012680027
T30	115	234	6,0	15,10	3	012680030
T40	130	257	7,0	17,50	2	012680040



1268RTX/S8
T9-T10-T15-T20
T25-T27-T30-T40

€ 109,50 1 012680307

1269PZ

Schroevendraaiers voor Pozidriv®-Supadriv® kruiskopschroeven



UNI/ISO 8764

PZ	L mm	L1 mm	€	U	PC
0	60	160	7,50	5	012690000
1	80	188	9,40	5	012690001
2	100	219	11,30	5	012690002
3	150	277	16,50	3	012690003
4	200	327	20,60	3	012690004



1269PZ/S4
PZ0-PZ1-PZ2-PZ3

€ 44,50 1 012690304

1269N/PZ

Schroevendraaiers voor Pozidriv®-Supadriv® kruikopschroeven, korte uitvoering



UNI/ISO 8764

PZ	L mm	L1 mm	€	U	PC
1	30	87	7,75	5	012690011
2	30	87	8,55	5	012690012

1281BG

Handgreep voor verwisselbare klingen



L mm	Ø mm	€	U	PC
118	10	12,90	5	012810280

1281PM

Magnetische bithouder met snelsluiting



L mm	€	U	PC
165	22,40	5	012810292

1281PB

Dopsleutelhouder met 1/4" aansluiting



L mm	€	U	PC
175	18,00	5	012810293

1281LP

Omkeerbare schroevendraaier klingen voor sleufschroeven



1281LP/1	€	U	PC
0,8x4-1,2x6,5 mm	11,40	5	012810302
1281LP/2	€	U	PC
1x5,5-1,2x6,5 mm	11,40	5	012810304

1281PH

Omkeerbare schroevendraaier klingen voor Phillips® kruiskopschroeven



PH	€	5	012810310
1-2	11,40		
2-3	11,40		

1281LPH

Omkeerbare schroevendraaier klingen voor sleuf en Phillips® kruiskop schroeven



	€	5	012810321
1281LPH/1 PH0-0,8x4 mm	11,40		
1281LPH/2 PH1-1x5,5 mm	11,40		
1281LPH/3 PH2-1,2x6,5 mm	11,40		

1281PZ

Omkeerbare schroevendraaier klingen voor Pozidriv®-Supadriv® kruis schroeven



PZ	€	5	012810330
1-2	11,40		
2-3	11,40		

1281PE

Omkeerbare schroevendraaier klingen voor inbus schroeven



mm	€	5	012810342
2,5	11,50		
3	11,50		
4	11,50		
5	11,50		
6	11,50		

1281TX

Omkeerbare schroevendraaier klingen voor Torx® schroeven



	€	5	012810349
1281TX/1 T6-T8	12,50		
1281TX/2 T7-T9	12,50		
1281TX/3 T10-T15	12,50		
1281TX/4 T20-T25	12,50		
1281TX/5 T30-T40	12,50		

1281RTX

Omkeerbare schroevendraaier klingen voor Tamper Resistant Torx® schroeven



	€	5	012810361
1281RTX/3 T10-T15	12,70		
1281RTX/4 T20-T25	12,70		
1281RTX/5 T30-T40	12,70		

1281BG/A9

assortiment of 9 reversible screwdrivers and 1 accessory in case



1281BG/A9	€	1	012810520
	134,50		

1281BG	
1281LPH/1	PH0-0,8x4 mm
1281LPH/2	PH1-1x5,5 mm
1281LPH/3	PH2-1,2x6,5 mm
1281PZ/1	PZ1-PZ2
1281PE	2,5 mm
1281PE	3 mm
1281PE	4 mm
1281PE	5 mm
1281PE	6 mm

1281BG-TX/A8

assortment of 8 reversible screwdrivers and 1 accessory in case



1281BG-TX/A8	€	1	012810530
	128,00		

1281BG	
1281LPH/1	PH0-0,8x4 mm
1281LPH/2	PH1-1x5,5 mm
1281LPH/3	PH2-1,2x6,5 mm
1281TX/1	T6-T8
1281TX/2	T7-T9
1281TX/3	T10-T15
1281TX/4	T20-T25
1281TX/5	T30-T40

1281BG/B28NA

assortiment van 16 omkeerbare schroevendraaiers, 9 1/4" doppen, 2 toebehoren en 1 handvat, in duurzame polyester foudraal



1281BG/B28NA	€	1	012810511
	303,00		

900	
1281BG	4 - 4,5 - 5 - 5,5 - 6 - 7 - 8 - 9 - 10 mm
1281PB	1/4"
900/25	
1281LP/1	0,8x4 - 1,2x6,5 mm
1281LP/2	1,0x5,5 - 1,2x6,5 mm
1281PH/1	PH1 - PH2
1281PH/2	PH2 - PH3
1281PZ/1	PZ1 - PZ2
1281PZ/2	PZ2 - PZ3
1281PE	2,5 - 3 - 4 - 5 - 6 mm
1281TX/1	T6 - T8
1281TX/2	T7 - T9
1281RTX/3	T10 - T15
1281RTX/4	T20 - T25
1281RTX/5	T30 - T40

2002/BV7-ZIP	€	1	020020060
	23,30		



De **BetaMax-schroevendraaiers** vertrouwen op verschillende technische kenmerken om het werk nog gemakkelijker te maken.

- De handgreep is geïnspireerd op het driehoekige gedeelte, dat zorgt voor optimaal schroeven, gebaseerd op een bereik van 120°, in lijn met maximale posrotatie.
- Het ontwerp biedt opmerkelijke ergonomische eigenschappen, zowel bij snel schroeven als bij vastdraaien.
- De verchromde vrije punt zorgt voor een perfecte koppeling met de schroef en wordt tegen oxidatie beschermd door een fosfaatcoatingbehandeling.

1290

Schroevendraaier voor sleufschroeven



ISO 2380

SxAxL mm	L1 mm	Ø mm	€		
0,4x2,5x50	146	2,5	8,10	5	012900003
0,4x2,5x75	171	2,5	8,20	5	012900006
0,5x3x75	171	3,0	8,45	10	012900009
0,5x3x100	196	3,0	8,95	10	012900012
0,6x3,5x75	171	3,5	9,10	10	012900018
0,6x3,5x100	196	3,5	9,25	10	012900021
0,8x4x100	196	4,0	9,50	10	012900030
0,8x4x125	221	4,0	9,60	10	012900033
0,8x4x150	246	4,0	10,60	10	012900036
1x5,5x100	209	5,0	10,70	10	012900039
1x5,5x150	259	5,0	11,80	10	012900042
1,2x6,5x100	220	6,0	13,30	10	012900048
1,2x6,5x150	270	6,0	14,00	10	012900051
1,2x8x150	282	7,0	17,30	3	012900057
1,2x8x200	332	7,0	18,10	3	012900060
1,6x10x200	332	8,0	21,20	3	012900066
2x12x250	382	10	28,50	2	012900069

1290/S

Schroevendraaier set



	€		
1290/S5	61,00	1	012900305
1290			0,5x3x75-0,8x4x100 -1x5,5x150 1,2x6,5x150 -1,2x8x150 mm

	€		
1290/S9X	114,00	1	012900319
1290			0,4x2,5x75 - 0,5x3,5x100 0,8x4x125 - 1x5,5x150 1,2x6,5x150 - 1,2x8x200 1,6x10x200 mm
1290N			0,8x4x30 -1,2x6,5x30 mm

1290N

Schroevendraaier voor sleufschroeven, korte uitvoering



ISO 2380

SxAxL mm	L1 mm	Ø mm	€		
0,8x4x30	86	4	10,30	5	012900103
1,2x6,5x30	86	6	11,50	5	012900106

1292

Schroevendraaier voor Philips® kruiskopschroeven



UNI/ISO 8764

PHxDxL mm	L1 mm	€		
0x3x60	156	7,40	10	012920003
0x3x100	196	8,35	5	012920006
1x4,5x80	189	10,10	10	012920009
1x4,5x120	229	11,30	10	012920012
2x6x100	220	13,10	10	012920018
2x6x150	270	14,50	10	012920021
3x8x150	282	18,20	3	012920024
4x10x200	332	26,00	3	012920027



	€		
1292/S4	49,00	1	012920304
			PH0x3x60-PH1x4,5x80 PH2x6x100-PH3x8x150 mm

1292N

Schroevendraaier voor Philips® kruiskopschroeven, korte uitvoering



UNI/ISO 8764

PHxDxL mm	L1 mm	€		
1x4,5x30	86	9,75	5	012920103
2x6x30	86	10,60	5	012920106

1292L

Schroevendraaier voor Philips® kruiskopschroeven, lange uitvoering

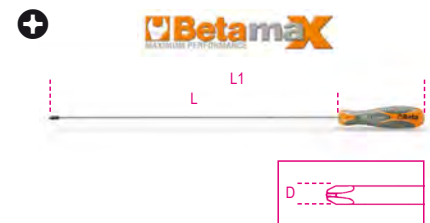

UNI/ISO 8764-1

PHxDxL mm	L1 mm	€		
0x3x300	396	16,90	3	012920203
1x4,5x400	509	20,50	3	012920206
2x6x400	520	25,50	3	012920209



1293/D...

Schroevendraaier set



1293/D6	€ 65,50	1	012930401
1290	0,6x3,5x75-1x5,5x150 1,2x6,5x150 mm		
1292	PH0x3x60 -PH1x4,5x80 PH2x6x100 mm		

1293/D8	€ 91,50	1	012930403
1290	0,5x3x75-0,8x4x100 1x5,5x150-1,2x6,5x150 1,2x8x150 mm		
1292	PH0x3x60 -PH1x4,5x80 PH2x6x100 mm		

1293/S...

Schroevendraaier set



1293/S8	€ 82,50	1	012930208
1290	2,5x50-3x75-4x100-5,5x150 6,5x150 mm		
1292	PH0x3x60-PH1x4,5x80 PH2x6x100 mm		

1293/S10	€ 129,50	1	012930201
1290	0,4x2,5x50 -0,6x3,5x100 1x5,5x100-1,2x6,5x150 1,2x8x150-1,6x10x200 mm		
1292	PH0x3x60 -PH1x4,5x80 PH2x6x100-PH3x8x150 mm		

1293/S12	€ 141,50	1	012930203
1290	0,5x3x75-0,8x4x125 1x5,5x150-1,2x6,5x150 1,2x8x200 mm		
1290N	0,8x4x30 mm		
1292	PH0x3x60 -PH1x4,5x80 PH2x6x100-PH3x8x150 mm		
1292N	PH1x4,5x30-PH2x6x30 mm		

1293/S7	€ 66,50	1	012930207
1292	PH0x3x60 -PH1x4,5x80 PH2x6x100 mm		
1294	0,5x2,5x60-0,6x3x75 0,8x4x100-1x5x125 mm		

1293ES

Schroevendraaier met binnenzeskant



mm	L mm	L1 mm	Ø mm	€		
2	100	196	3	10,50	5	012930001
2,5	100	196	4	10,50	5	012930002
3	100	196	4	11,00	5	012930003
4	100	196	5	12,80	5	012930004
5	100	209	6	14,10	5	012930005
6	125	245	7	15,60	5	012930006
8	150	282	10	20,80	2	012930008



1293ES/S7	€ 95,50	1	012930057
2-2,5-3-4-5-6-8 mm			

1293BP

Schroevendraaier met kogelkop



mm	L mm	L1 mm	€		
2	100	196	10,70	5	012930501
2,5	100	196	10,90	5	012930502
3	100	196	11,00	5	012930503
4	100	196	12,40	5	012930506
5	100	209	13,60	5	012930509
6	125	245	15,60	5	012930512
8	150	282	22,30	2	012930515



1293BP/S7	€ 96,50	1	012930558
2-2,5-3-4-5-6-8 mm			

1294

Schroevendraaier voor verzonken sleufschroeven



SxDxL mm	L1 mm	€		
0,5x2,5x60	156	7,10	5	012940003
0,6x3x75	171	7,80	5	012940006
0,6x3x100	196	8,00	5	012940009
0,8x4x100	196	9,25	5	012940012
0,8x4x150	246	13,00	5	012940015
1x5x125	234	11,90	5	012940018
1,2x6,5x150	282	14,30	5	012940027



1294/S5	€ 50,50	1	012940305
0,5x2,5x60-0,6x3x100 0,8x4x100-1x5x125 1,2x6,5x150 mm			

1294L

Schroevendraaier voor verzonken sleufschroeven, lange uitvoering



SxDxL mm	L1 mm	€		
0,6x3x300	396	15,90	3	012940206
0,8x4x400	496	19,10	3	012940209
1x5x400	509	23,20	3	012940215
1,2x6,5x400	532	26,00	3	012940218

1295

Slagschroevendraaier



1295	€ 70,00	1	012950001
L mm 130			



1295/C14

Slagschroevendraaier met 14 bit en houder in kist



1295/C14 € 167,00 1 012950108

	866LP	1,2x6,5 - 1,6x10 mm
	866PH	PH2 - PH3
	866PZ	PZ2 - PZ3
	866PE	5 - 6 mm
	866TX	T27 - T30 - T40 - T45 - T50 - T55
	895/6	□ 1/2 - ○ 5/16
	1295	■ 1/2

170x100x35 mm - 1,3 kg

1297TX

Schroevendraaier voor Torx® schroeven



Ø	L mm	L1 mm	Ø mm	€	Hand	Computer
T6	50	146	3,0	13,70	5	012970006
T7	50	146	3,0	14,00	5	012970007
T8	60	156	3,0	14,20	5	012970008
T9	60	169	4,0	14,60	5	012970009
T10	80	189	4,0	15,50	5	012970010
T15	80	189	4,0	16,00	5	012970015
T20	100	209	4,5	16,40	5	012970020
T25	100	209	5,0	16,60	5	012970025
T27	115	235	6,0	17,80	5	012970027
T30	115	235	6,0	18,50	5	012970030
T40	130	262	7,0	20,80	2	012970040
T45	130	262	8,0	23,30	2	012970045



1297TX/S12 € 201,50 1 012970312
T6-T7-T8-T9-T10
T15-T20-T25-T27
T30-T40-T45



Betamax



1297TX/D6 € 101,00 1 012970409
T10-T15-T20
T25-T27-T30

1297TX/L

Schroevendraaiers voor Torx® schroeven, lange uitvoering



Ø	L mm	L1 mm	Ø mm	€	Hand	Computer
T15	210	319	4,0	17,80	2	012970115
T20	210	319	4,5	18,10	2	012970120
T25	210	319	5,0	18,80	2	012970125
T30	210	330	6,0	20,30	2	012970130
T45	210	342	8,0	22,40	2	012970145



Betamax



1297TX/L-S5 € 97,50 1 012970325
TX/L15-TX/L20-TX/L25-
TX/L30-TX/L45

1298RTX

Schroevendraaier voor Torx® schroeven



Ø	L mm	L1 mm	Ø mm	€	Hand	Computer
T9	60	169	4,0	16,10	5	012980009
T10	80	189	4,0	16,60	5	012980010
T15	80	189	4,0	17,70	5	012980015
T20	100	209	4,0	18,20	5	012980020
T25	100	209	4,5	18,40	5	012980025
T27	115	235	5,5	19,20	5	012980027
T30	115	235	6,0	20,50	5	012980030
T40	130	262	7,0	22,10	2	012980040



Betamax



1298RTX/S8 € 149,00 1 012980308
T9-T10-T15-T20
T25-T27-T30-T40

1299PZ

Schroevendraaier voor kruiskop Pozidriv® - Supadriv® schroeven



UNI/ISO 8764

PZ	L mm	L1 mm	€	Hand	Computer
0	60	156	10,90	5	012990000
1	80	189	12,70	5	012990003
2	100	220	17,10	5	012990006
3	150	282	24,60	2	012990009
4	200	332	34,00	2	012990012



Betamax



1299PZ/S6 € 90,50 1 012990306
1299PZ PZ0-PZ1-PZ2-PZ3
1299N/PZ PZ1-PZ2

1299N/PZ

Schroevendraaier voor kruiskop Pozidriv® - Supadriv® schroeven extra korte uitvoering



UNI/ISO 8764

PZ	L mm	L1 mm	€	Hand	Computer
1	30	86	12,00	5	012990021
2	30	86	13,40	5	012990024

Beta
Quality Tools

VOERTUIG REPARATIE

Onze reparatie gereedschappen voor voertuigen, die worden gebruikt door de meest veeleisende professionals, zijn ontwikkeld en vervaardigd om te voldoen aan de hoogste normen ter wereld en worden regelmatig getest onder de meest stressvolle bedrijfsomstandigheden.

Al meer dan 50 jaar werken we met trots samen met de grootste kampioenen, die ons non-stop helpen onze producten te verbeteren en te bewijzen volgens de hoogste kwaliteitsnorm.

De voertuig reparatie gereedschappen zijn te vinden in deze secties:

Diagnose	artikel 1438 tot 1499 artikel 1758VT tot 1760TMC
Mototr	artikel 955 tot 989A artikel 1438 tot 1499
Olie en filters	artikel 1438 tot 1499 artikel 1877 tot 1885
Elektrisch systeem	artikel 1438 tot 1499
Startboosters	artikel 1498BC/12 tot 1498/40A
Versnelling	artikel 1438 tot 1499
Ophanging	artikel 1549 tot 1569CP
Remmen	artikel 1438 tot 1499
Wielen	artikel 955 tot 989A
Carrosserie gereedschap	artikel 1302 tot 1369 artikel 1763 tot 1767A
Overig gereedschap	artikel 1875LT tot 3067
Garagekriks	artikel 3029/2T tot 3067/70-13T



1302

Handtas met steel en gebogen baan



g 770 € 105,50 1 013020001

1303

Handtas in komvorm



g 1350 € 76,00 1 013030001

1304

Handtas met gleuf



g 875 € 103,00 1 013040001

1305

Handtas in wigvorm



g 1190 € 63,50 1 013050001

1305Z

Handtas in wigvorm met gewafelde baan



g 1065 € 76,00 1 013050002

1306

Handtas in hakvorm



g 1040 € 61,00 1 013060001

1307

Handtas, universeel

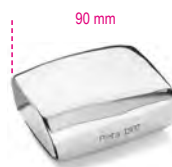

g 1100 € 117,50 1 013070001

1308

Handtas in eivorm



g 1100 € 111,50 1 013080001

1310

Handtas in railvorm



g 1225 € 64,00 1 013100001

1312

Handtas in aambeeldvorm



g 1220 € 145,50 1 013120001

1314

Handtas in diabolovorm met gewelfde baana



g 760 € 67,00 1 013140001

1326

Lepel, gebogen en spits



g 560 € 60,00 1 013260001

1327

Lepel, smalle slanke baan



g 1075 € 84,00 1 013270001

1328

Lepel, korte brede baan



g 935 € 76,00 1 013280001

1329

Lepel, kort gebogen model



g 1800 € 225,50 1 013290001

1330

Lepel, gebogen brede baan



g 2125 € 242,00 1 013300001

1331

Buigijzer met leer bekleedt



g 1100 € 134,00 1 013310001

1335BM

Slagvijl met kunststof handgreep



g 500 € 40,50 2 013350010

1337/S5

5-delig set carrosseriespatels, vervaardigd uit roestvaststaal

Japans model
(25-50-75-100-125 mm)



L mm 25-50-75-100-125 € 15,20 1 013370015

1338A - 1338B

Verstelbare carrosserievijl met flexibele platte vijlbladen



1338A 9 360 111,00 2 013380001
1338B 12 360 115,00 2 013380002

1338

Vijlbladhouder voor model 1338R



1338 € 59,00 2 013380003

1338R9 - 1338R12

Reserve vijlbladen voor model 1338A-B



1338R9 9 52,00 2 013380004
1338R12 12 56,00 2 013380005

1342

Rechte platte beitel



L mm 235 € 37,50 5 013420001

1342PM

Rechte platte beitel met handbeschermer

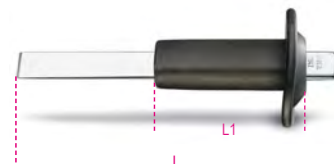

L mm 235 L1 mm 118 € 51,50 2 013420002

1342PMR

Reserve handbeschermer voor model 1342



1342PMR € 13,90 1 013420003

1343

Platte beitel met zijlemmet



L mm 200 € 37,50 5 013430001

1344

Carrosserie voelermaten voor de schadehersteller, paar, 10-bladen, met zuignap

Geschikt voor:

- Afstellen achterraut
- Het vasthouden van ingestelde positie tijdens monteren



1344 € 44,50 1 013440010

1344A/VW

Haaksleutel voor het losmaken van Volkswagen handgrepen



L mm 260 € 18,90 1 013440100

1345

Uitdeukhamer met ronde bolle baan en gebogen pen, houten steel



1345 € 50,50 2 013450010

1351

Uitdeukhamer met ronde vlakke baan en eikelvormig pen, houten steel



1351 € 52,50 2 013510010

1353

Uitdeukhamer met ronde vlakke baan en puntige pen, houten steel



1353 € 54,50 2 013530010

1357Z/45

Uitdeukhamers met ronde vlakke gewafelde baan en vierkante vlakke baan, houten steel



1357Z/45 € 86,00 2 013570045

1359T

Uitdeukhamers met ronde vlakke ronde vlakke baan en horizontale pen, houten steel



1359 T € 49,50 2 013590010

1360G

Terugslagvrije rubber hamer, voor het plaatsen van pakkingen en delicate onderdelen

HET EXTREEM ZACHTE SLAGVLAK VOORKOMT BESCHADIGINGEN dat onderdelen waaraan wordt gewerkt, beschadigd raken, omdat ze de impact absorbeert door te vervormen.



L mm 280 Ø mm 72 € 89,00 1 013600000

1360/K6

Aluminium hamer met een rond plat slagvlak, verwisselbare kunststof uitdeukpennen

Geleverd met:

- 4 kunststof pennen
- 1 centerpunt, instelbaar in 2 verschillende lengtes, tevens passend op de hamer



L mm 320 Ø mm 34 € 101,00 1 013600006

1360/KP3

Carrosserie hamers met bolle en pen kop, uitdeukpen, vervaardigd uit kunststof

Kit omvat:

- 1 210 g hamer met kop Ø 30 mm
- 1 290 g hamer met kop Ø 40 mm
- 1 75 g uitdeukpen met 5 mm punt



1360/KP3 € 95,50 1 013600503

1361/C12

Set van Teflon® pennen voor schadeherstel werkzaamheden



1361/C12 € 145,00 1 013610012

275x160x57 mm

1361/K9

uitdeukset 8 delig voor plaatwerk

Inhoud kit:

- ronde kogelkops tang, Ø 31 mm, lengte 110 cm
- tipstang, lengte 62 cm
- walvisstaart puntstang, lengte 112 cm
- haakpuntstang, lengte 27 cm
- platte ronde kopstang, lengte 50 cm
- ronde kogelkopstang, Ø 19 mm, lengte 52 cm
- walvisstaartkopstang, lengte 27 cm
- ronde walvisstaartkopstaaf, lengte 28 cm
- stoffen tas met handvatten

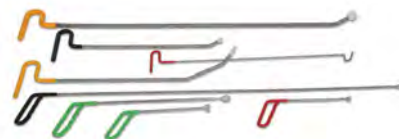

1361/K9 € 349,00 1 013610030

1362B

Ronde reflectie plaat gemaakt van textiel

- oppervlak volledig voorzien van een krasvast materiaal
- geleverd in een kleine transporttas



1362B	Ø mm	€		
	755	91,50	1	013620011

1364SE

Mobiele, verstelbare carrosserie drager

Specificaties:

- 4 zwenkwielen, 2 met remmen
- Leggers kunnen worden verlengd tot 1400 mm
- Verticaal instelbaar tot 1315 mm
- Positie vergrendeling
- Contactoppervlak bedekt met afneembaar rubber

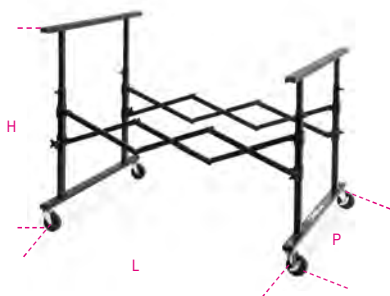

	L mm	H mm	P mm	€		
	215-1400	780-1315	890	465,00	1	013640001

1364SV

Carrosserie-ondersteuning met centrale lade

Specificaties:

- Contactoppervlak bedekt met polyethyleen
- Lade-afmetingen: 340x845x40 mm
- Opklapbaar



	H mm	€		
	1000	265,00	1	013640002

1364SCP

Verstelbare carrosserie-ondersteuning

Vooral geschikt voor kappen, schermen en deuren
Uitgerust met 4 zwenkwielen - 2 stuurwielen met rem
180° draaibaar



	H mm	L mm	P mm	€		
	1300	1100	680	425,00	1	013640003

1364SP

Carrosserie-ondersteuning met zuignappen

Bijzonder geschikt voor gebruik met ramen

Uitgerust met 4 zuignappen, Ø 95 mm
Opening kan worden aangepast door middel van een ketting
Polyethyleen beklede buis



	H mm	L mm	€		
	1250	950	210,00	1	013640004

1364SR

Dispenser op wielen
Maskeerpapierrollen

Specificaties:

- met 2 transportwielen
- 3 papierrolbeugels met ingebouwd papersnijmes
- ingebouwde ondersteuning voor papieren tape
- max. afmetingen papierrol: 350 - 650 - 1050 mm



	L mm	P mm	H mm	H1 mm	€	
	1530	520	1080	960	245,00	1

1365/K13

Hydraulisch uitdeukset 10 t, compleet met toebehoren in verrijdbare koffer

Het set bevat:

- Hydraulische pomp, 10 t, met 1,5 meter slang en 1/2" koppeling
- Vijzel
- Spreider; capaciteit: 500 kg
- Bodemplaat, 150x90 mm
- L-vormig voetplaat, 50x50 mm
- 4-puntig opzetstuk
- Ronde gegroefd opzetstuk, Ø 50 mm
- Wigvormig opzetstuk, 43 mm
- 170-mm-lang verlengstuk
- 300-mm-lang verlengstuk
- 400-mm-lang verlengstuk
- 530-mm-lang verlengstuk
- Rubber rond opzetstuk
- Man-man aansluiting voor het koppelen van de hulpstukken.



1365/K13	€		
	885,00	1	013650013

900x420x180 mm

1365P10

Hydraulische oliepomp

1,5-meter lange olieslang, 1/2" koppeling



1365P10	€		
	396,00	1	013650110

1366A

Deukentrekker met set van 19 kunststof lijm pads

Ideaal voor het verwijderen van:

- deuken veroorzaakt door hagel
- deuken veroorzaakt door andere autodeuren
- kleine deuken over het algemeen



1366A	€		
	112,50	1	013660200

1366B

Slaggewicht voor kunststof
lijm pads

Hamer gewicht: 500 g



L
mm 440 € 56,50 1 013660250

1366KF

19-delig assortiment kunststof pads
voor artikel 1366A



1851VK-12V - 018510072

1366/KF € 41,50 1 013660205

1366/K5

Pneumatische uitdeuktrekker, met 1.1 kg
slaggewicht

Het set bevat:

- 1 zuignap Ø 75 mm
- 1 zuignap Ø 100 mm
- 1 zuignap Ø 125 mm
- 1 haak



1366/K5 € 263,00 1 013660010

610x240x90 mm

1366SH

multifunctionele
carrosserie spotter

- Microprocessor voor het automatisch regelen van de lasparameters
- Contact- en handmatige lascyclusstart
- Automatische instelling van de lastijd
- Geleverd met een snel koppelingspistool en 2,2 m lange grondkabel

Accessoire kit inhoud:

- Extractor hamer
- Drie-punts washoofd
- 10 driepuntige sluitringen
- Koolstofelektrode
- Splashing -elektrode



Technische gegevens:

- Voeding: 230V
- 50% vermogen: 2,5 kVa
- Power Peak: 13 KVA
- AMP -uitgang: 2850 (2%) a
- Max. AMP -uitgang: 3200 A

1366SH € 2.090,00 1 013660400

1366SH/C

Trolley voor spotter 1366sh



1366SH/C € 408,00 1 013660410

1366SL

Hefboom pull hulpstuk
voor het repareren deuken op metalen
oppervlakten

Voorzien van multahaak puller
voor het gebruik met wave lasdraad



L
mm 700 € 210,50 1 013660002

1366ST

Brug pull hulpstuk
voor het repareren deuken op metalen
oppervlakten

Voorzien van multahaak puller
voor het gebruik met wave lasdraad



L
mm 850 € 670,00 1 013660003

1366S/R1

3 punts trekplaatouder



1366S/R1 € 27,00 1 013660501

1366S/R2

3-zijdige puntplaat
voor het trekken van metaaldelen



1366S/R2 € 27,00 1 013660502

Afgebeelde prijzen zijn voor 20 stuks

1366S/R3

Elektrode voor ringen
Ø 8x16x1.5 mm



1366S/R3 € 33,00 1 013660503

Beta

1366S/R4

Trekogen, Ø 8x16x1.5 mm



1366S/R4 € 28,00 1 013660504

1366S/R5

Vulringen Ø 8x16x1.5mm



1366S/R5 € 15,60 1 013660505

Afgebeelde prijzen zijn voor 100 stuks

1366S/R6

Elektrode voor M5-M6 schroeven



1366S/R6 € 32,00 1 013660506

1366S/R7

100 zelftappende draadeinden, 5x18 mm



1366S/R7 € 27,00 1 013660507

1366S/R8

100 zelftappende draadeinden, 5x25 mm



1366S/R8 € 37,00 1 013660508

1366S/R9

100 draadeinden, M5 x 18 mm



1366S/R9 € 25,00 1 013660509

1366S/R10

10 trekringen



1366S/R10 € 17,60 1 013660510

1366S/R11

Elektrode voor gedraaide trekringen



1366S/R11 € 89,00 1 013660511

1366S/R12

10 90° gedraaide trekking



1366S/R12 € 34,50 1 013660512

1366S/R13

Elektrode voor het rechtekken van plaatwerk



1366S/R13 € 64,50 1 013660513

Afgebeelde prijzen zijn voor 5 stuks

1366S/R14

Elektrode voor wavedraad



1366S/R14 € 31,50 1 013660514

1366S/R21

Waved lasdraad te gebruiken met hefboom en brug hulpstuk



1366S/R21 € 25,00 1 013660551

De vermelde prijzen zijn voor 10 stuks

1366S/R22

magnetisch hulpstuk voor wave lasdraad



1366S/R22 € 72,50 1 013660552

1366S/R24

Trek oog M4



1366S/R24 € 83,50 1 013660554

De vermelde prijzen zijn voor 5 stuks

1366S/R25

Trek oog M5



1366S/R25 € 83,50 1 013660555

De vermelde prijzen zijn voor 5 stuks

1366S/R26

Trek oog M6



1366S/R26 € 83,50 1 013660556

De vermelde prijzen zijn voor 5 stuks

1367/S4

Set matrijzen voor het maken van gaten voor parkeersensoren

Maten:
23 - 24 - 27 - 28

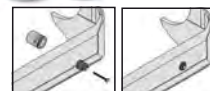

1367/S4 € 266,00 1 013670104



1367/K4

Set van 4 wielkastklemmen, type wielkast



Maximale opening: 6,5 mm

	L	H	S	€		
	mm	mm	mm			
1367/K4	62	40+58	15,7	70,00	1	013670010

1367/K10

Set van gereedschappen voor het maken van gaten voor parkeersensoren

Set bevat:

• sizes: 17 - 18 - 18.2 - 19 - 20 - 22.5 - 24 - 26 - 26.7 - 32 mm



∅ 12 mm



	€		
1367/K10	216,00	1	013670200

190x130x58 mm

1368

Apparaat voor het herstellen van kunststof

• Maakt het mogelijk om gescheurde en gebroken kunststof delen snel te repareren

Voeding: 220-240 V met Schuko stekker

Kabellengte pistool: 3,5 m

Kabellengte apparaat: 1,35 m

2 vermogensinstellingen: 35-75 W

Hitte pistool met koperen geleiders, 2 kram insteekhoeken: 0°-90°

Apparaat beveiliging: thermische circuit onderbreker

Uitgaande beveiliging: 10 A zekering

Metalen pistoolhouder

CE



	€		
1368	478,00	1	013680001

1368G/K400

Assortiment van 400 krammen voor artikel 1368



	€		
1368G/K400	82,50	1	013680140

1368G/OD

Gegolfde krammen, recht, voor artikel 1368



	€		
1368G/OD	20,60	1	013680100

De afgebeelde prijzen zijn per 100 stuks.

1368G/SD

Spiraalgevormde krammen, recht, voor artikel 1368



	€		
1368G/SD	20,60	1	013680110

De afgebeelde prijzen zijn per 100 stuks.

1368G/CV

Haakse bolle krammen voorartikel 1368



	€		
1368G/CV	20,60	1	013680120

De afgebeelde prijzen zijn per 100 stuks.

1368G/C2U

Haakse holle krammen voor artikel 1368



	€		
1368G/C2U	20,60	1	013680130

De afgebeelde prijzen zijn per 100 stuks.

HAMERSTELLEN

Stelen gemaakt van hickoryhout Hickory is een houtsoort met uitstekende eigenschappen, die perfect passen bij hamerstelen. De lange vezelstructuur absorbeert trillingen en maakt het extreem bestendig tegen breken. In het onwaarschijnlijke geval dat sommige vezels breken, is de kans dat de kop er ineens loskomt sowieso erg klein. Houten stelen kunnen worden vervangen als ze versleten zijn. Omdat hout een natuurlijk materiaal is, moet het zijn eigen vocht vasthouden. Daarom mag de hamer niet op een te droge plaats worden bewaard.

Stelen gemaakt van glasfiber Stelen met een kern van glasfiber zijn zowel duurzaam als veilig; het risico op breuk en verwondingen wordt tot een minimum beperkt. Ze zijn weerbestendig en bestand tegen de meest voorkomende chemicaliën.



• Onverwoestbare kern van glasfiber

• Ergonomisch handgreep van polypropyleen

• Antislip, comfortabele elastomeercoating

1369/C11

11-delig assortiment gereedschappen



1369/C11 € 943,00 1 013690033

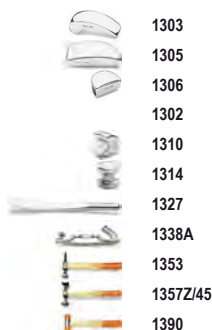

470x340x70 mm - 15,2 kg

1370

Bankhamers met houten steel



HICKORY

UNI 7778 DIN 1041

g	A mm	L mm	L1 mm	€		
100	15	260	82	13,60	5	013700051
200	19	280	95	16,10	5	013700052
300	23	300	105	18,20	5	013700053
400	25	310	112	20,40	5	013700054
500	27	320	118	22,30	5	013700055
600	30	330	122	24,90	5	013700056
800	33	350	130	27,50	4	013700058
1000	36	360	135	33,50	4	013700060
1500	42	380	145	38,00	2	013700065
2000	47	400	155	44,00	1	013700070

1370/MR...

Reserve steel voor model 1370



	€		
1370MR 100 1370/100	6,85	4	013700081
1370MR 200 1370/200	7,50	4	013700082
1370MR 300 1370/300	8,00	4	013700083
1370MR 400 1370/400	8,70	4	013700084
1370MR 500 1370/500	9,55	4	013700085
1370MR 600 1370/600	10,40	4	013700086
1370MR 800 1370/800	11,20	4	013700088
1370MR 1000 1370/1000	11,90	4	013700090
1370MR 1500 1370/1500	13,60	4	013700095
1370MR 2000 1370/2000	14,80	4	013700100

1370T

Bankhamers met kunststof steel



g	A mm	L mm	L1 mm	€		
200	19	280	95	25,00	5	013700620
300	23	300	105	27,00	5	013700630
500	27	320	118	30,00	5	013700650
800	33	350	130	31,00	4	013700680
1000	36	360	135	39,50	4	013700700
1500	42	365	145	46,00	2	013700750

1370F

Bankhamer, Frans model houten steel



NF E 71.014

A mm	L mm	L1 mm	€		
24	260	77	280	23,00	2 013700424
26	260	80	310	25,00	2 013700426
28	280	86	400	26,00	2 013700428
30	280	92	450	27,50	2 013700430
32	300	100	550	28,00	2 013700432
36	300	104	720	39,00	2 013700436
40	330	110	1065	41,00	2 013700440
42	330	116	1080	43,00	2 013700442
50	380	138	1760	45,00	2 013700450
60	380	160	2585	55,00	2 013700460

1370F/MR...

Reserve steel voor model 1370F



	€		
1370F/MR 24 1370F/24-26	6,50	2	013700474
1370F/MR 28 1370F/28-30	7,40	2	013700478
1370F/MR 32 1370F/32-36	8,50	2	013700482
1370F/MR 40 1370F/40-42	10,60	2	013700490
1370F/MR 50 1370F/50	11,90	2	013700495
1370F/MR 60 1370F/60	14,70	2	013700496

1370FT

Klinkhamer, kunststof steel met glasfiber kern



A mm	L mm	L1 mm	€		
28	280	86	530	37,50	1 013700528
30	280	92	625	39,50	1 013700530
32	300	100	750	40,50	1 013700532
36	300	104	930	49,50	1 013700536
40	330	110	1150	52,50	1 013700540
42	330	116	1250	54,00	1 013700542
50	380	138	2100	60,50	1 013700550
60	380	160	2750	64,50	1 013700560

1374F

Timmermanshamer, Frans model houten steel



NF E 71.012

A mm	L mm	L1 mm	€		
16	250	80	180	18,80	2 013740416
20	270	86	250	20,40	2 013740420
22	290	92	335	20,90	2 013740422
26	290	103	425	24,50	2 013740426
28	310	108	510	25,00	2 013740428
30	310	117	580	26,00	2 013740430

1374F/MR...

Reserve steel voor model 1374F



	€		
1374F/MR 16 1374F/16	6,05	2	013740456
1374F/MR 20 1374F/20	6,35	2	013740460
1374F/MR 22 1374F/22-26	6,45	2	013740462
1374F/MR 28 1374F/28	7,30	2	013740468
1374F/MR 30 1374F/30	7,55	2	013740470



1375

Klauwhamer houten steel



g	L1 mm	Ø mm	L mm	€	Hand icon	Computer icon
300	95	25	300	21,00	3	013750000

1375/MR

Reserve steel voor model 1375



1375/MR	€ 10,40	Hand icon	Computer icon	2 013750003
---------	---------	-----------	---------------	-------------

1375A

klauwhamers, handgrepen van kunststof en glasvezel



oz	g	L mm	L1 mm	€	Hand icon	Computer icon
16	450	330	130	33,00	3	013750016
20	570	330	130	35,50	3	013750020

1375B

Klauwhamers stalen steel



oz	g	L mm	L1 mm	€	Hand icon	Computer icon
16	450	330	130	30,00	3	013750026
20	570	330	130	31,50	3	013750030

1376X

Klauw hamers met vierkant slagvlak, magneten en spijkerhouder houten steel



g	A mm	L1 mm	L mm	€	Hand icon	Computer icon
250	20	125	450	22,50	3	013760125
300	25	130	450	22,90	3	013760130
400	27	132	450	25,00	3	013760140

1376X/MR

Reserve steel voor model 1376X



1376X/MR	€ 12,70	Hand icon	Computer icon	2 013760161
----------	---------	-----------	---------------	-------------

1376XT

Klauw hamers met vierkant slagvlak, magneten en spijkerhouder kunststof steel



g	A mm	L1 mm	L mm	€	Hand icon	Computer icon
250	20	125	500	25,50	3	013760525
300	25	130	500	26,50	3	013760530
400	27	132	500	27,50	3	013760540

1376XT/MR

Reserve steel voor hamer 1376XT



1376MR/XT	€ 15,60	Hand icon	Computer icon	2 013760585
-----------	---------	-----------	---------------	-------------

1377

Bolbankhamers voor koper en metaalbewerking houten steel



		HICKORY				
g	L mm	L1 mm	€	Hand icon	Computer icon	
340	330	95	31,50	2	013770134	
450	350	102	33,00	2	013770145	
570	350	110	39,50	2	013770157	
680	360	116	40,50	2	013770168	
900	380	120	42,50	2	013770190	

1377/MR...

Reserve steel voor model 1377



1377MR 340 1377/340	€ 8,20	Hand icon	Computer icon	2 013770234
1377MR 450 1377/450	9,20	2	013770245	
1377MR 570 1377/570	9,90	2	013770257	
1377MR 680 1377/680	10,20	2	013770268	
1377MR 900 1377/900	12,40	2	013770290	

1377T

Bolbankhamers, ronde kop, voor koper- en tin smeden, kunststof steel



g	L mm	L1 mm	€	Hand icon	Computer icon
340	330	95	28,00	2	013770534
450	350	102	34,00	2	013770545
570	350	110	38,00	2	013770557
680	360	116	41,00	2	013770568
900	380	120	47,00	2	013770590

1378

Penbankhamers houten steel



		HICKORY				
g	L mm	L1 mm	Ø mm	€	Hand icon	Computer icon
340	330	100	27	30,00	2	013780134
570	350	115	32	37,50	2	013780157

1378/MR...

Reserve steel voor model 1378



1378MR 340 1378/340	€ 7,05	Hand icon	Computer icon	2 013780234
1378MR 570 1378/570	10,20	2	013780257	

1379F

Elektricienshamers Frans model houten steel



		HICKORY				
A mm	L mm	L1 mm	€	Hand icon	Computer icon	
16	250	126	19,70	2	013790416	
18	250	135	21,10	2	013790418	
20	260	142	22,70	2	013790420	

1379F/MR...

Reserve steel voor model 1379F



	€		
1379F/MR 16	7,00	2	013790426
1379F/16-18			
1379F/MR 20	7,40	2	013790430
1379F/20			

1380

Vuisten houten steel



HICKORY

UNI 7777 DIN 6475

g	A mm	L mm	L1 mm	€		
800	38	260	90	25,00	2	013800208
1000	40	260	95	27,00	2	013800210
1250	43	260	100	29,00	2	013800212
1500	45	280	110	32,50	2	013800215
2000	50	300	120	43,00	2	013800220

1380/MR...

Reserve steel voor model 1380



	€		
1380MR 800	8,70	2	013800238
1380/800-1000-1250			
1380MR 1500	9,55	2	013800245
1380/1500			
1380MR 2000	11,00	2	013800250
1380/2000			

1380S

Mokers met veiligheidshuls houten steel



g	A mm	L mm	L1 mm	€		
800	36	260	90	26,50	2	013800400
1000	39	260	95	29,00	2	013800405
1250	43	260	100	32,00	2	013800410
1500	45	260	110	36,50	2	013800415

1380S/MR...

Reserve steel voor model 1380S



	€		
1380S/MR 800	8,55	2	013800417
1380S/800-1000-1250			
1380S/MR 1500	9,65	2	013800419
1380S/1500			

1380T

Mokers, kunststof steel



g	A mm	L mm	L1 mm	€		
800	35	260	85	35,00	2	013800308
1000	40	260	100	35,00	2	013800310
1250	42	260	110	39,00	2	013800312
1500	45	260	120	42,50	2	013800315
2000	49	295	120	49,00	1	013800320

1381

Voorhamers hickory steel



HICKORY

g	A mm	L mm	L1 mm	€		
3000	55	800	142	99,00	1	013810030
4000	60	900	152	110,00	1	013810040
5000	70	900	162	125,00	1	013810050
8000	80	900	185	215,50	1	013810080

1381/MR...

Reserve steel voor model 1381



	€		
1381MR 3-4	52,00	2	013810730
1381/3000-4000			
1381MR 5	57,00	2	013810750
1381/5000			
1381MR 8	56,00	2	013810780
1381/8000			

1381T

Voorhamers, kunststof steel



g	A mm	L mm	L1 mm	€		
3000	55	900	142	99,00	1	013810330
4000	60	900	152	117,00	1	013810340
5000	70	900	162	125,00	1	013810350
8000	82	920	180	225,00	1	013810380

1385

Koperen hamers houten steel



g	A mm	L mm	L1 mm	€		
400	26	260	75	40,00	2	013850404
600	32	270	80	59,00	2	013850406
800	34	280	90	75,00	2	013850408
1000	37	280	100	89,00	2	013850410
1500	43	280	110	139,00	2	013850415
2000	48	300	120	179,00	1	013850420

1385/MR

Reserve steel voor hamer 1385



	€		
1385MR 400	11,60	2	013850464
1385 400			
1385MR 600	11,90	2	013850466
1385 600			
1385MR 800	12,50	2	013850468
1385 800			
1385MR 1000	13,10	2	013850470
1385 1000			
1385MR 1500	15,10	1	013850475
1385 1500			
1385MR 2000	15,60	1	013850480
1385 2000			

1390

Kunststof hamers met verwisselbare koppen houten steel



UNI 7784

Ø mm	L mm	L1 mm	€		
22	260	70	22,20	5	013900022
28	280	85	27,50	5	013900028
35	310	95	38,50	5	013900035
45	320	107	59,50	4	013900045
60	380	128	100,00	2	013900060

1390/MR...

Reserve steel voor model 1390



	€		
1390MR 22	5,95	2	013900222
1390/22			
1390MR 28	6,50	2	013900228
1390/28			
1390MR 35	8,15	2	013900235
1390/35			
1390MR 45	9,80	2	013900245
1390/45			
1390MR 60	11,80	2	013900260
1390/60			

1390R

Hamerdoppen voor model 1390



Ø mm	€		
22	4,00	4	013900122
28	5,95	4	013900128
35	7,95	4	013900135
45	13,20	4	013900145
60	23,40	4	013900160

1390N

Nylon hamers, houten steel

Medium-hard slagvlak: 75 Shore
Olie en slijtage bestendig
Zeer geschikt voor metaalbewerking



UNI 7784

Ø mm	L mm	L1 mm	€		
22	260	70	22,20	3	013900522
28	280	85	27,50	3	013900528
35	310	95	38,50	3	013900535
45	320	107	59,50	2	013900545
60	380	128	100,00	2	013900560

1390NR

reserve nylon koppen voor artikel 1390N



Ø mm	€		
22	3,60	4	013900622
28	5,40	4	013900628
35	7,20	4	013900635
45	12,00	4	013900645
60	21,20	4	013900660

1391

Terugslagvrije hamers volledig met rubber overtrokken



Ø mm	L mm	L1 mm	€		
35	280	90	34,00	2	013910135
50	320	105	44,00	2	013910150
55	355	110	53,00	2	013910155
65	380	130	74,00	2	013910165

1391A

Terugslagvrije hamers voor tegelzetters volledig met rubber overtrokken



g	Ø mm	L mm	L1 mm	€		
500	45	290	100	32,50	2	013910205
1000	60	300	120	44,00	2	013910210

1392

Terugslagvrije hamers met verwisselbare koppen stalen steel



Ø mm	L mm	L1 mm	€		
30	300	105	60,00	2	013920030
35	305	115	64,00	2	013920035
40	310	125	72,50	2	013920040
50	325	135	85,50	2	013920050
60	385	155	128,00	2	013920060

1392R

Hamerdoppen voor model 1392



Ø mm	€		
30	8,20	4	013920230
35	12,50	4	013920235
40	18,20	4	013920240
50	24,60	4	013920250
60	36,50	4	013920260

1393

Hard rubber hamer



Ø mm	L mm	L1 mm	€		
50	315	90	14,00	3	013930050
60	340	110	16,40	3	013930060
70	370	130	19,60	2	013930070

VOERTUIG REPARATIE

Onze reparatie gereedschappen voor voertuigen, die worden gebruikt door de meest veeleisende professionals, zijn ontwikkeld en vervaardigd om te voldoen aan de hoogste normen ter wereld en worden regelmatig getest onder de meest stressvolle bedrijfsomstandigheden. Al meer dan 50 jaar werken we met trots samen met de grootste kampioenen, die ons non-stop helpen onze producten te verbeteren en te bewijzen volgens de hoogste kwaliteitsnorm.

De voertuig reparatie gereedschappen zijn te vinden in deze secties:

Diagnose	artikel 1438 tot 1499 artikel 1758VT tot 1760TMC
Mototr	artikel 955 tot 989A artikel 1438 tot 1499
Oil and filters	artikel 1438 tot 1499 artikel 1877 tot 1885
Elektrisch systeem	artikel 1438 tot 1499
Startboosters	artikel 1498BC/12 tot 1498/40A
Versnelling	artikel 1438 tot 1499
Ophanging	artikel 1549 tot 1569CP
Remmen	artikel 1438 tot 1499
Wielen	artikel 955 tot 989A
Carrosserie gereedschap	artikel 1302 tot 1369 artikel 1763 tot 1767A
Overig gereedschap	artikel 1875LT tot 3067
Garagekriks	artikel 3029/2T tot 3067/70-13T



1410/M

Trekhaak



Ø mm	€	Hand	Computer
3,5	19,90	2	014100051

1428

Bout en moer verwijderaar



Ø mm	□ mm	L mm	Ø mm	€	Hand	Computer
8	3/8	36	17	20,30	2	014280008
10	3/8	36	17	20,30	2	014280010
11	3/8	36	17	20,30	2	014280011
12	3/8	36	19	20,30	2	014280012
13	3/8	36	19	20,30	2	014280013
14	3/8	36	19	20,30	2	014280014
15	1/2	38	21	21,50	2	014280015
16	1/2	38	21	21,50	2	014280016
17	1/2	38	21	21,50	2	014280017
18	1/2	38	26	21,50	2	014280018
19	1/2	38	26	21,50	2	014280019
20	1/2	38	26	24,70	2	014280020
21	1/2	38	26	24,70	2	014280021
22	1/2	38	26	27,00	2	014280022
24	1/2	38	26	27,00	2	014280024
27	1/2	38	26	29,00	2	014280027

1428L

Dopsleutel, lange uitvoering voor het verwijderen van beschadigde moeren



Ø mm	€	Hand	Computer
17	54,50	1	014280217
19	56,50	1	014280219
21	59,00	1	014280221



1428L/B3	€	Hand	Computer
17-19-21 mm	165,50	1	014280303



1428/SB11	€	Hand	Computer
8-10-11-12-13-14 15-16-17-18-19 mm	249,50	1	014280111
1428/SB5	143,50	1	014280115
20-21-22-24-27 mm			

1429

bout en tapeind verwijderaars met aandrijfvierkant



mm	□	L mm	€	Hand	Computer
2	3/8	60	13,80	3	014290002
3	3/8	60	13,80	3	014290003
4	3/8	60	13,80	3	014290004
5	3/8	60	14,90	2	014290005
6	3/8	60	14,90	2	014290006
8	1/2	70	16,70	2	014290008
10	1/2	70	17,00	2	014290010



1429/SB7	€	Hand	Computer
2-3-4-5-6-8-10 mm	119,00	1	014290107

1430/...

Tapeinduithalers vervaardigd uit gehard en geslepen staal

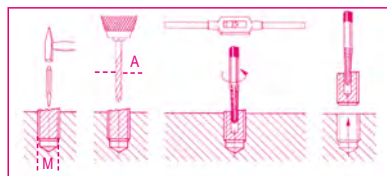

	M	A mm	€	Hand	Computer
1430/1	3÷6	2,5	4,05	10	014300006
1430/2	6÷8	3,0	4,40	10	014300008
1430/3	8÷11	4,5	5,30	10	014300011
1430/4	11÷14	6,0	6,95	10	014300014
1430/5	14÷18	8,0	7,90	10	014300018
1430/6	18÷24	11,0	15,30	5	014300024
1430/7	24÷33	14,0	22,70	5	014300033
1430/8	33÷50	21,0	29,00	5	014300050



1430/S5	€	Hand	Computer
1430/1-1430/2-1430/3 1430/4-1430/5	29,00	1	014300105
1430/S6	41,00	1	014300106
1430/1-1430/2-1430/3 1430/4-1430/5-1430/6			
1430/S8	91,50	1	014300108
1430/1-1430/2-1430/3 1430/4-1430/5-1430/6 1430/7-1430/8			

1431/...

Tapeind uithalers voor afgebroken schroeven en draadeinden

"Voor het verwijderen van schroeven en tapeinden die niet stevig kunnen worden vastgehouden, slag-mechanisme

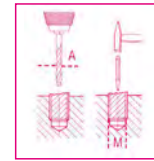

	M	A	L	□	€	Hand	Computer
1431/3	3÷6	2,5	59	5	6,80	10	014310051
1431/5	6÷8	5,0	68	5	6,80	10	014310052
1431/6	8÷11	6,0	72	6	8,05	10	014310053
1431/8	11÷14	8,0	77	8	8,80	10	014310054
1431/9	14÷18	9,0	82	9	9,30	10	014310055

1431/C5

Tape uitdraaiset voor beschadigde schroeven en draadeinden

Slag mechanisme

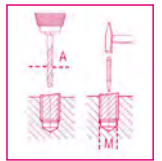

1431/C5	M mm	A mm	€	Hand	Computer
	3÷18	2,5÷9	38,50	1	014310005

1433

Tapeinduithalers

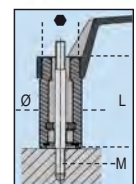

M mm	Ø mm	L mm	• mm	□	€	Hand	Computer
5	21	60	19	3/8	15,50	2	014330005
6	24	60	21	1/2	15,50	2	014330006
7	24	60	21	1/2	15,50	2	014330007
8	24	60	21	1/2	15,50	2	014330008
9	28	70	21	1/2	18,10	2	014330009
10	28	70	21	1/2	18,10	2	014330010
10,5	28	70	21	1/2	18,10	2	014330021
11	28	70	21	1/2	18,10	2	014330011
12	28	70	21	1/2	18,10	2	014330012
14	36	72	24	-	28,50	2	014330014
16	36	72	24	-	28,50	2	014330016

1433/C11

Tapeind uithalers met rol en 1/2" insteek vierkant

38"
12"



1433/C11 € 295,00 1 014330311
M5 - M6 - M7 - M8 - M9 - M10 - M10,5
M11 - M12 - M14 - M16
340x135x56 mm - 3,0 kg

1435

Tapeinduithalers met wig



Ø mm € 109,00 1 014350001
4÷20

1435R

Reserve wiel voor model 1435



1435R € 34,50 1 014350010

1435/1

Tapeinduithalers met wig



Ø mm € 135,00 1 014350002
19÷26

1435/1R

Reserve wiel voor model 1435/1

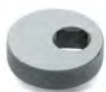

1435/1R € 35,50 1 014350011

1437/C12

12-delig assortiment gereedchappen voor het verwijderen van airbags



1437/C12 € 100,00 1 014370001
260x160x55 mm - 1,0 kg

1438

Universeel koppelings centreerapparaat compleet met drie spanconussen



1438 € 61,50 1 014380001

1438R

Reserve spanconus voor model 1438



Ø mm € 5 014380101
14÷18 4,40 5 014380102
18÷21 4,40 5 014380103
22÷25 4,40 5 014380103

1438EVO

Universele koppelingsplaat centreerset

Componenten zijn geheel vervaardigd uit metaal



1438EVO € 273,00 1 014380011
290x200x60 mm - 2 kg

1438DSG

Hefboom voor het vastzetten en loshalen bij een DSG dubbele-clutch versnellingsbak van de VAG groep



1438DSG € 39,00 1 014380200

1438K/DSG-2

Gereedschapsset voor het uitlijnen van 6- en 7-traps DSG koppeling

Voor het gebruik met 6-traps DSG en handgeschakelde bak, 7-traps DSG (series 1 en 2) en S-tronic versnellingsbakken.



1438K/DSG-2 € 687,00 1 014380260

350x370x117 mm - 10 kg

1438K/PWR

Gereedschapsset voor het verwijderen/installeren van Powershift transmissie met dubbele koppeling



1438K/PWR € 470,00 1 014380270

440x400x85 mm - 10 kg

1438DCT/S

Gereedschapset voor het uitlijnen van Ford droge dubbele koppeling

Voor het uitlijnen van de koppeling na het uitvoeren van werkzaamheden zoals het vervangen van de oliekeerring



1438DCT/S	€ 358,00	1	014380305
≡ 440x400x85 mm - 8 kg			

1439/K7

Haakse schroevendraaier (90°) lange uitvoering, met bits in kunststof koffer.



Koffer inhoud: - Haakse schroevendraaier
1 kop voor sleufschroeven
1 bithouder - speciale kop
7 verschillende bits.

1439K7	€ 233,00	1	014390101
≡ 500x120x60 mm 825 g			

1440/...

Zuigerveerklemmen



	Ø mm	L mm	€		
1440/0	40÷75	50	33,00	1	014400000
1440/1	57÷125	80	42,50	1	014400010
1440/1A	57÷125	100	49,00	1	014400011
1440/2	90÷175	80	53,00	1	014400020
1440/2A	90÷175	100	55,50	1	014400021
1440/3	90÷175	165	79,50	1	014400030

1445/1 - 1445/2

Zuigerveertangen



	Ø mm	€		
1445/1	50÷100	44,50	1	014450001
1445/2	90÷150	55,50	1	014450002

1452K

Klepveerlichter, met 3 bekken

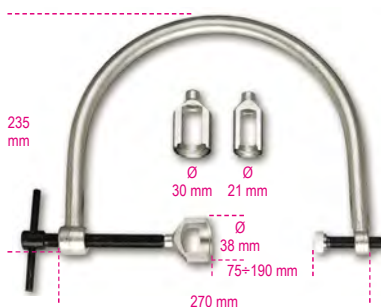

1452K	€ 171,50	1	014520100
-------	----------	---	-----------

1452PN/K

Pneumatische klepveerlichter

Duwkracht: 1400 N



Ø mm	L mm	L1 mm	€		
16-19-23	230	185	353,00	1	014520110
25-30-42					

1454P

Schraper voor het verwijderen van pakking en kitresten

Met name aanbevolen voor het reinigen kopdeksel en vlakke oppervlakken



L mm	L1 mm	€		
210	32	47,50	1	014540010

1455SVP

Pneumatische kleppenslijper

• Werkdruk: 6 bar



1455SVP	€ 424,00	1	014550001
---------	----------	---	-----------

1455SVP/R...

Reserve rubber zuignappen voor model 1455SVP



	€		
1455SVP/R1	7,85	5	014550501
1455SVP/R2	7,85	5	014550502
1455SVP/R3	7,85	5	014550503

1457/B4

Gereedschap voor het ontkoppelen van Riisan slangkoppelingen

Het set bevat de maten:

- 6x8
- 10x12
- 15x16
- 18x1/2



1457/B4	€ 50,50	1	014570024
---------	---------	---	-----------

1458

Seegeringtang



DIN 5417

Ø mm	€		
30÷100	80,50	2	014580001

1460F

Klepafdichtringtang



1460F € 69,00 1 014600010

1462CF/C6

6-delig set van open twaalfkant dopsleutels voor brandstofleiding aansluitingen

Maten:

12-14-16-17-18-19 mm

12"



1462CF/C6 € 111,00 1 014620006

260x145x60 mm - 1,2 kg

1462CF

Open twaalfkant dopsleutels voor brandstofleiding aansluitingen

12"



mm	€		
12	17,90	1	014620012
14	18,10	1	014620014
16	18,40	1	014620016
17	18,60	1	014620017
19	19,10	1	014620019
18	18,80	1	014620018

1462CF-SN/C6

6-delig set set van open zeskant dopsleutels met kniegewricht voor brandstofleiding moeren.

Maten:

12-14-16-17-18-19

3/8"



1462CF-SN/C6 € 167,00 1 014620026

275x182x64 mm

1462CF-SN

bandenpomp

3/8"



mm	€		
12	28,00	1	014620032
14	28,50	1	014620034
16	30,50	1	014620036
17	31,50	1	014620037
18	33,00	1	014620038
19	33,50	1	014620039

1462/KI

Assortiment van common rail diesel injectie trekkers

Maakt het mogelijk DELPHI-BOSCH-SIEMENS-DENSO injectoren te verwijderen



1462/KI € 2.800,00 1 014620235

530x470x140 mm - 2,0 kg

1462/KU

Universeel gereedschapsset voor het verwijderen van diesel common rail injectoren
Compleete met trekker en slaggewicht



1462/KU € 829,00 1 014620100

390x290x100 mm - 4,5 kg

1462/MB

slag kit voor het verwijderen van injectoren

Set-inhoud:

- 1 4 kg slagvlak met 400 mm staaf
- 1 adapter, mannelijk M10x1,5, vrouwelijk M22x1,5 mm
- 1 adapter, mannelijk M22x1,5, vrouwelijk M13x1,4 mm
- 1 adapter, mannelijk M14x1,5, vrouwelijk M27x1 mm
- 1 adapter, mannelijk M14x1,5, mannelijk M25x1 mm
- 1 adapter, mannelijk M14x1,5, mannelijk M27x1 mm
- 1 adapter, mannelijk M14x1,5, vrouwelijk M14x1,5 mm
- 1 adapter, mannelijk M14x1,5, mannelijk M20x1 mm
- 1 adapter, mannelijk M14x1,5, mannelijk M17x1 mm



1462/MB € 345,00 1 014620110

500x250x80 mm - 7,2 kg

1462AD/BSC

Adapter voor het verwijderen van Bosch common rail injectoren

Te gebruiken in combinatie met de Beta artikelen 960KI en 1462/KU



1462AD/BSC € 245,00 1 014620435

1462AD/SMN

Adapter set voor het verwijderen van Siemens en Denso injectoren

Te gebruiken in combinatie met de Beta artikelen 960KI/1462KI



1462AD/SMN € 365,00 1 014620436

1462/EI

Universeel vibratie gereedschap voor het demonteren van injectoren

- Helpt bij het volledig verwijderen van vastzittende injectoren uit hun behuizing, zonder de cilinderkoppen te beschadigen of de injectoren af te breken.
- Kan gebruikt worden in combinatie met elk ander injector verwijdergereedschap, met of zonder slagvlak.
- Het apparaat werkt direct op de trekstang, welke gekoppeld is aan de injector, door vibraties en pulse.
- Controle klep maakt het instellen van de intensiteit mogelijk afhankelijk van de uit te voeren werkzaamheden.

CE



1462/EI € 745,00 1 014620240

 **Beta**
Quality Tools

1463/KIT

Klepstel systeem met poelie blokkeer



1463/KIT	€ 425,00	1	014630001
≡ 280x140x75 mm - 1,2 kg			

1464T

Digitaal testapparaat voor het meten van druk en compressie



Tesamen met artikel 960AD/TP2, is het mogelijk de volgende testen uit te voeren:

- Benzine en dieselmotor compressie
- Motor oliedruk
- Common rail lage druk
- Benzine injectie druk

Met artikel 1464AP, is het mogelijk de volgende testen uit te voeren:

- Actuele common rail systeem druk
- Hogedruk pomp druk

SPECIFICATIES

- 5" touch screen beeldscherm
- Oplaadbare polymeer lithium batterij
- Compleet met 80 bar druksensor (voor lage druk) en USB kabel

1464T	€ 970,00	1	014640050
--------------	----------	---	-----------

1464T/SP80

Druksensor, 80 bar, voor artikelen 1464T en 960TP



1464T/SP80	€ 335,00	1	014640053
-------------------	----------	---	-----------

960AD/TP2

Set van adapters voor item 960TP in kunststof koffer



960AD/TP2	€ 550,00	1	009600510
≡ 430x310x50 mm - 3,2 kg			

1464CBD

Uitgebreide adapterset voor het testen van compressie in benzine- en dieselmotoren, met tester 1464T

Maakt het mogelijk om de motor om benzine- en dieselcompressiete koppelen en te testen met testapparaat 1464T

Inhoud:

- 8 dummy bougies met terugslagkleppen
- 44 dummy-gloeibougies met terugslagkleppen
- 1 verstelbare universele dummy-injector voor auto's, vrachtwagens, scheepsmotoren en landbouwmachines
- 1 90° adapter, overdrukventiel en aansluitslang
- ruimte voor tester 1464T in kofferkoppeling



1464CBD	€ 850,00	1	014640300
≡ 510x410x140 mm - 5,5 kg			

1464IC

Compleet set van dummy injectoren en dummy gloeispiralen voor artikel 1464T

Maakt het mogelijk de digitale tester artikel 1464T aan de motor te koppelen om de compressie te testen bij diesel motoren.

Bevats:

- 22 dummy gloeispiralen
- 5 dummy injectoren
- 1 universele dummy injector kit voor autos, trucks, marine motoren en agrarische machines



1464IC	€ 649,00	1	014640350
≡ 559x312x50 mm - 4,5 kg			

1464IC/RK

Universele dummy injectoren kit voor autos, trucks, marine motoren en agrarische voertuigen

Geleverd met artikel 1464IC



1464IC-RK	€ 219,00	1	014640377
≡ 200x110x30 mm - 885 g			

1464AP

Set voor het testen van hoge druk systeem bij common rail diesel motoren, met artikel 1464T

Compleet met:

- Hoge druk pijpset
- Aansluitingen
- 2,000 bar sensor



1464AP	€ 879,00	1	014640450
≡ 430x310x50 mm - 1,8 kg			

1464AP T

Hoge drukpijp voor artikelen 1464AP en 960TAP



1464AP T12X12	€ 74,00	1	014640453
1464AP T12X14	€ 74,00	1	014640454
1464AP T14X12-M1,0	€ 74,00	1	014640455

1464AP T16X12



1464AP T16X12	€ 85,00	1	014640456
----------------------	---------	---	-----------

1464FG

Assortiment van dummy regulateuren voor het testen van het diesel common rail systeem

(te gebruiken met Beta artikelen 1464T-1464AP)

In combinatie met het testapparaat en geschikte adapters, maakt het mogelijk om vast te stellen of het probleem veroorzaakt wordt in de hoge druk pomp of in de reguleur indien er geen druk is in het hoge druk is in het specifieke gedeelte bij common rail



1464FG € 353,00 1 014640470

350x250x80 mm - 1,8 kg

1464FG/CP4

Dummy reguleur voor Bosch CP4 pomp, niet meegeleverd met artikel 1464FG



1464FG/CP4 € 54,00 1 014640475

1464APB

Set voor het testen van hoge druk systeem in FSI benzine motoren, voor het gebruik in combinatie met artikel 1464T

Geleverd met een 200 bar sensor en aansluitingen



1464APB € 469,00 1 014640500

240x210x50 mm - 0,5 kg

1464PB

9-delig set van snel koppelingen for het testen lage druk van brandstof (te gebruiken met Beta artikel 1464T)

Snelkoppelingen voor testapparaat 1464T maakt het mogelijk de lage druk bij diesel en benzine inspuiting snel te controleren



1464PB € 608,00 1 014640700

530x440x120 mm - 3,8 kg

1464ADB

Hulpset voor het testen van druk in het AdBlue® systeem voor artikel 1464T

Geleverd met adapters met een 80-bar standaard sensor geleverd met artikel 1464T



1464ADB € 103,50 1 014640620

240x210x50 mm - 0,5 kg

1464FAP

Hulpset voor het testen van de druk van diesen deeltjes filter (DPF) voor artikel 1464T

Geleverd met:
- 500 mbar sensor
- 8 mm adapter met snelkoppeling en T stuk
- 3-m-lange RJ45 kabel



TECHNISCHE DATA
Druktest: 0÷500 mbar
Resolutie: 1 mbar

1464FAP € 221,50 1 014640610

240x210x50 mm - 0,5 kg

1464PT

Set voor het testen van turbo druk, voor het gebruik in combinatie met artikel 1464T

Geleverd met sensor en aansluitkabel



1464PT € 201,50 1 014640550

240x210x50 mm - 380 g

1464TDI

Set voor het testen pomp druk in TDI motoren, voor het gebruik in combinatie met artikel 1464T

Geleverd met aansluitkoppeling



1464TDI € 145,00 1 014640600

240x210x50 mm - 400 g

1464VD

Vacuum test set voor artikel 1464T

Voor het meten en opslaan van de maximale vacuüm waarde
Geleverd met
- 800 mbar sensor
- 6 en 8 mm adapters
- 3-m-lange RJ45 kabel

TECHNISCHE DATA
Vacuüm test: 0÷800 mbar
Resolutie: 1 mbar
Max. waarde opslag



1464VD € 223,00 1 014640570

240x210x50 mm

 **Beta**

1464PF

Set voor het testen van druk in het rem systeem, voor gebruik in combinatie met artikel 1464T Geleverd met adapters en aansluitkoppelingen



1464PF € 810,00 1 014640650
400x280x60 mm - 3 kg

1465

Motor efficiëntie tester

Het apparaat maakt het mogelijk de compressie te testen van een endothermische motor in slechts enkele seconden zonder deze aan te sluiten aan de motor. Het meten van de spanning van de accu met behulp van daarvoor specifieke software is voldoende.



Stap 1: bereken het toerental van de motor
Stap 2: test de accuspanning tijdens elke omwenteling
Stap 3: Geef aan het opgenomen vermogen en compressie gecalculeerd tijdens start procedure voor elke zuiger
Stap 4: test de laadspanning van de accu en de efficiëntie
TECHNISCHE SPECIFICATIES
Werk voltage: 12V DC (voertuig accu)
Afmetingen: 140x75x30 mm
Lengte kabel: 1300 mm
Gewicht: 215 g

1465 € 1.335,00 1 014650010

1466/C5

5-delig set van rem vloeistof aftapsleutels

Set bevat:
• 5 sleutels met de maten 7-8-9-10-11 mm
• 1 aftapslang met controle klep



1466/C5 € 150,00 1 014660100
260x170x50 mm - 600 g

1466L 11

Remvloeistof aftapsleutel, 11 mm, lange uitvoering



1466L 11 € 37,00 1 014660211
11 mm L 60 mm

1466TLF

Remvloeistof opvangtank capaciteit: 1.5 l

Snelkoppeling voor aftapslang Ø 5.5 mm



1466TLF € 53,50 1 014660201

1467

Remvloeistof vulapparaat



Druk: min 5 bar, max 11.5 bar

1467 € 350,00 1 014670001

1467/RK1

Reserve slangen voor artikel 1467LF



1467/RK1 € 30,00 1 014670501

1467/RK2

Reserve vulaansluiting voor artikel 1467



1467/RK2 € 110,00 1 014670502

1467LF/2

Elektronisch apparaat voor het vervangen van remvloeistof

Met "pulserend effect" functie



- Stopt automatisch zodra het reservoir leeg is, en voorkomt dat er lucht in het systeem komt
 - Maximale tank volume: 20 l
 - Werkdruk: 0.4÷3.5 bar
 - Voeding: 230V
- Geleverd met:
- Remolie opvangtank
 - 1 standaard aansluiting E20

1467LF/2 € 2.050,00 1 014670099

1467LF/RC

Vaatje met opvangslang voor artikel 1467LF



1467LF RC € 132,50 1 014670125

1467TU

Aansluitstuk voor remvloeistof reservoirs

- Is passend op 90% van de bestaande reservoir
- Te gebruiken in combinatie maar Beta's artikel 1467LF



1467TU € 82,50 1 014670090

1467T/C6

Set van aansluitstukken voor remvloeistof reservoirs, te gebruiken in combinatie met de BETA artikelen 1467LF en 1467LF/2

Set bevat:

- 1 plug voor Toyota voertuigen
- 1 plug voor Ford, Hyundai, Mazda, Mitsubishi, Nissan, Subaru voertuigen
- 1 plug voor Honda voertuigen
- 1 plug voor Mazda en Suzuki voertuigen
- 1 plug voor Nissan voertuigen
- 1 aansluitstuk voor Europese voertuigen



1467T/C6 € 299,00 1 014670080

350x240x85 mm - 1,8 kg

1470

Remveertang



L mm	€	1	014700001
210	44,50	1	014700001
330	55,50	1	014700002
540	184,00	1	014700010

1470FT

Universele borgveertang voor trommelremmen

40° gebogen bekken
Eenvoudig te werken in ongemakkelijke plekken



L mm 184 € 47,00 1 014700000

1470PF

Gereedschap voor het vervangen van cilinders in trommelremmen

De klauwen blijven open, voor het eenvoudig vervangen van de cilinders

38"



Ø 17 mm

A mm 25÷140 € 101,00 1 014700200

1471

Remveertang



L mm 330 € 88,00 1 014710001

1471A

Handremafsteltang

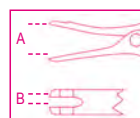

220 mm

A max mm 45 B mm 5 € 110,50 2 014710010

1471GF

Een paar vormbare haken voor bijvoorbeeld het ondersteunen van remklauwen bij het vervangen van remblokken.



1471GF Max kg 5 € 17,20 1 014710310

Beta

1471M/C22

Pneumatisch aangedreven gereedschap voor het terug duwen en links en rechtsom draaien van remzuigers met toebehoren



1471M/C22 € 338,00 1 014710101

350x310x85 mm - 3,5 kg

1471M/50

Luchtaangedreven apparaat voor het terug drukken, rechts en links draaien van remzuigers



Ø mm 50 Kg 150 Bar 5÷8 € 188,00 1 014710069

1471M/P

TRW-Mégane opvul en pas hulpstukken



1471M/P € 29,00 1 014710080

1471M/W50

VW Passat handrem adapter ≥ 2005

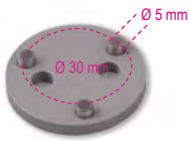

1471M/W50	€ 10,00	1	014710079
-----------	---------	---	-----------

1471PN/B1

Ford handrem adapter

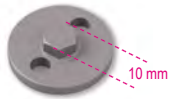

1471PN/B1	€ 10,00	1	014710081
-----------	---------	---	-----------

1471PN/B2

Daily handrem adapter



1471PN/B2	€ 14,00	1	014710082
-----------	---------	---	-----------

1471PN/B3

BMW handrem adapter



1471PN/B3	€ 10,00	1	014710083
-----------	---------	---	-----------

1471PN/B4

BMW handrem adapter



1471PN/B4	€ 10,00	1	014710084
-----------	---------	---	-----------

1471PN/B5

Mini/ BMW handrem adapter

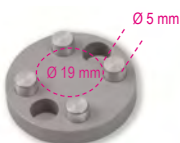

1471PN/B5	€ 10,00	1	014710085
-----------	---------	---	-----------

1471CF

Vijfvlaks dopsleutels voor remzuigers



mm	€	1	014710314
14	19,60	1	014710314
19	19,60	1	014710319

1471CM

Vijfvlaks sleutel voor remzuigers



mm	€	1	014710360
10	19,60	1	014710360

1471CM/E11

Dopsleutel met zeskantprofiel, 11 mm, voor Mercedes ML remafstel schroeven (serie 166)



mm	Ø	L	L1	€	1	014710361
11	24	75	15,5	22,00	1	014710361

1471PT/C5

Slagdoppen set voor remklauwmoeren

Voor Volkswagen, Audi & Porsche Group
• 3 10-tands doppen: 11,5 mm - 15 mm - 20 mm
• 2 7-tands dop: Ø 14 mm - 22 mm



1471PT/C5	€ 82,00	1	014710367
-----------	---------	---	-----------

1471D2

Gereedschap voor het terugduwen van remzuigers met gesloten remklauwen

Twee paar platen voor het werken op 2 en 4 zuiger klauwen



mm	€	1	014710301
10	90,00	1	014710301

250x170x60 mm 1,5 kg

1471T/C5

5 slagsleutels voor remklauwen bij vrachtautos

Kan worden gebruikt met momentsleutels voor aandraai werkzaamheden

met de volgende maten:

- Inwendige Torx sleutels E18, E20, E24
- Ringsleutels M24, M26



1471T/C5	€ 286,00	1	014710400
----------	----------	---	-----------

275x220x60 mm - 3,1 kg

1472

Slangklemtang



1472	€ 49,50	1	014720001
------	---------	---	-----------

1472AU

Slangklemtang voor zelfklemmende slangklemmen



mm	€	1	014720100
18+53	151,00	1	014720100



1472R/AU

Reserve bekken voor tang artikel 1472AU



1472AU/R € 59,00 1 014720101

1472AU/P

Slangklemtang met verlengstuk voor zelfklemmende slangklemmen



∅ mm 18+54 L mm 630 € 132,00 1 014720105

1472AU/RP

Reserve kabel voor tang artikel 1472AU/P



1472AUP/R € 33,00 1 014720106

1472B/RNLT

Dubbele kop dopsleutel, speciaal ontwikkeld voor slangklemmen van aanzuigslangen geïnstalleerd op motoren van de Renault groep



1472B/RNLT € 20,30 1 014720250

1472FC

Clic® klembandtang met draaibare bekken



1472FC € 45,00 1 014720090

1472FC/GE

Zware Clic® slangklem tang

Uitermate geschikt voor grote slangklemmen



L mm 230 € 82,00 1 014720093

1472FC/L

Clic® collar pliers with flexible extension



L mm 630 € 125,00 1 014720095

1472FCL/RP

Reserve kabel voor tang artikel 1472FC/L



1472FCL/RP € 57,00 1 014720096

1472FCA

Slangklem tang voor Visa® type slangklemmen



1472FCA € 75,50 1 014720041

1472H

Demontage sleutel voor Henn klemmen



L mm 100 € 30,00 1 014720000

1472MT/VW

een paar ontgrendel pennen voor luchtinlaat kanalen in VAG automobielen

Toepasbaar op benzine voeruijen met turbo motoren 1.0 - 1.2 - 1.4



1472MT/VW € 13,10 1 014720500

1472TM

Tang voor snelkoppeling van multijet filters



1472TM € 32,00 1 014720200

1472VW

Slangklemtang met kantelbare bekken

Voor Volkswagen en Mercedes voertuigen



1472 VW € 53,50 1 014720051

1473

Oetiker® klembandtang



1473 275 € 150,50 1 014730001

1473A

Klemtang voor Oetiker® klembanden



1473A € 111,50 1 014730010

1473P

Slangklemtang voor OETIKER® lage klembanden



1473P A Max mm 53 € 39,00 1 014730020

1473FN

Klemtang voor het vastzetten en doorknippen van roestvast stalen klembanden
Voor het gebruik met Panduit(R) banden en soortgelijke



1473FN A mm 4,7÷9,5 € 77,50 1 014730501

1473T

Kniptang voor stalen slangklemmen

Maakt het mogelijk slangklemmen door te knippen zonder het risico van beschadiging aan de ashoes, slangen enz.



1473T A Max mm 14 L mm 220 € 71,00 1 014730582

1474/C4

4-delig set trekkers voor het verwijderen van Volkswagen bobines



1474/C4 € 116,50 1 014740100
290x190x50 mm - 1 kg

1474E/VW

Binnentrekker voor pen type injectorhouder, Volkswagen groep



1474E/VW € 32,50 1 014740120

1474E/VW2

bobine trekker, voor voertuigen van de VAG-groep
Voor het gebruik op motoren 1.0 - 1.2 - 1.4 - 2.0



1474E/VW2 € 42,50 1 014740150

1474L

Bougiekaptang, 15° gebogen bekken

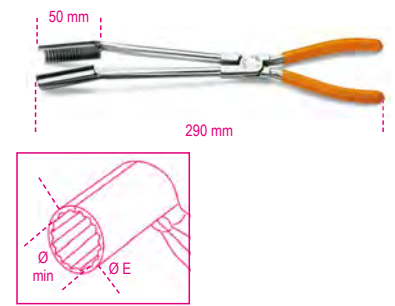

1474L Ø min mm 14 Ø E mm 20 € 97,00 2 014740010

1474DL

Bougiekap tang, lange bekken, dubbele PVC handgreep



1474DL € 43,50 1 014740015

1474G

Tang voor het verwijderen van beschermkapjes van gloeispiralen
Lange gebogen speciale bekken



1474G € 53,50 1 014740200

1475U

Extra lange platbek tang, hoog verchromd, dubbele PVC-handgreep

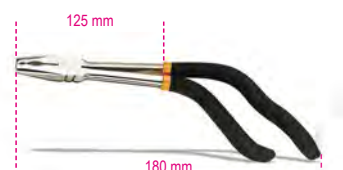

1475U € 40,00 1 014750010

1476

Verstelbare griptang voor het snijden van uitlaatpijp



225 mm

Ø min mm	Ø max mm	L mm	€	1	014760002
19	75	225	87,50		

1476/RC

Reserve snijketting voor 1476



1476RC	€ 45,00	1	014760012
--------	---------	---	-----------

1476A

Tang voor het snijden van uitlaatpijp



230 mm

Ø min mm	Ø max mm	€	1	014760005
30	95	116,50		

1476A/RC

Reserve snijketting voor 1476A



1476A/RC	€ 97,50	1	014760015
----------	---------	---	-----------

1476C/1

Optrompgereedschap voor uitlaatpijp



1476C/1	€ 44,50	1	014760101
Ø 30÷42 mm			
L = 131 mm			
L1 = 51 mm			

1476GT

Tang voor het verwijderen van steunrubbers van de uitlaatpijp



L mm	A Max mm	± mm	€	1	014760050
280	58	3	39,00		

1476PSA

Tang voor uitlaatklembanden met pen, PSA groep

De vorm van de bek en de blokkeerstand maakt het mogelijk aan de uitlaat te werken zonder de klemband te verwijderen



L mm	A Max mm	S mm	€	1	014760060
309	60	12,2	49,00		

1476T

Tang voor het verwijderen en monteren voor turbo's op Volkswagen Audi diesel motoren



105 mm

Ø mm	€	1	014760200
12	44,50		

1477/C10

Gebogen sleutel met 9 insteek ringsleutels voor

V snaar moeren

1 gebogen sleutel met open uiteinde

4 twaalfkant ring insteekstukken: 12x14 - 13x15 - 16x17 - 18x19 mm

5 Torx® profiel insteekstukken E10 - E12 - E14 - E16 - E18



1477/C10	€ 188,00	1	014770310
530x110x55 mm			

1477D

Ringsleutels voor het vastdraaien van V snaar moeren



555 mm

Ø mm	€	1	014770113
13	35,00		
15	35,00		
16	35,00		
17	35,00		
19	35,50		

1477D/S5

5-delig set ringsleutels voor Vsnaar moeren



1477D/S5	€ 175,50	1	014770200
13-15-16-17-19 mm			
600x200x70 mm - 2,2 kg			

1477K/7

Gebogen omschakelbare ratelssleutel met toebehoren



- 2 TORX T40-T45 bits
- 1 XZN 10 bit
- 1 zeskant bit, 8 mm
- 3 twaalfkant bits, 10-12-13 mm

1477K/7	L mm	€	1	014770051
	250	170,00		

1478

Bekledingstang



265 mm

1478	€ 64,50	1	014780001
------	---------	---	-----------

1478NSS

Plastic pin verwijdertang met 3 release-punten



L mm 180 € 48,00 1 014780163

1478T

Bekledingstang met knikbare kop en instelbare klauwen

De kop kan 90° knikken



S mm 4,5 € 52,50 1 014780101

1478/K3

pin tangenset met assortiment plastic clips

KIT INHOUD:

- Telefoontang (1 stuk)
- 90° gebogen telefoontang (1 pc.)
- 625 plastic clips in 16 verschillende maten
- Clips in 3 stapelbare PPL-opbergbakjes



L mm 180 L1 mm 170 € 117,00 1 014780160

1478SP

assortiment van 625 kunststof clips

16 verschillende soorten



€ 27,50 1 014780201

1479

Bekledingsvork

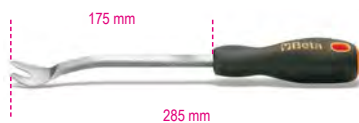

1479 € 28,00 2 014790001

1479/B27

27-delig set nylon gereedschappen voor het verwijderen van bekledingspinnen en werkzaamheden op kunststof en pakkingen, ophangbaar



1479/B27 € 89,00 1 014790407

1479LB/C5

5-delig set van metalen bekledingsvorken



1479LB/C5 € 126,50 1 014790150

215x165x50 mm

1479L/S2

Multifunctionele koevoeten, paar, vervaardigd uit Teflon®



1479L/S2 € 42,00 1 014790510

1479LV/S3

3-delig set multifunctionele breekijzers, vervaardigd uit metaal

Maten:

- 1479LV/1: 10x12 mm
- 1479LV/2: 4.8x9.6 mm
- 1479LV/3: 2.8x6 mm



1479LV/S3 € 36,00 1 014790100

1479L/K4

4 bekledingshevels voor werkzaamheden aan dashboards en delicate onderdelen



1479L/K4 € 39,00 1 014790604

1479ML/B17

17-delig set van multifunctionele breekijzers, vervaardigd uit kunststof

Zeer aanbevolen voor precisie werkzaamheden



1479ML/B17 € 75,00 1 014790700

1479ML/S3

3 delig set univesele breekijzers, Vervaardigd uit kunststof

Zeer aanbevolen voor precisie werkzaamheden



1479ML/S3 € 15,40 1 014790603

1479N/S5

5 delig set beklodingsvorken



1479N/S5 € 45,50 1 014790251

1479RB/1

Recht schraapmes



1479RB/1 € 32,00 1 014790315

1479RB/2

Gebogen schraapmes



1479RB/2 € 32,00 1 014790320

1479RB/3

Gebogen schraapmes



1479RB/3 € 37,50 1 014790310

1479U/13

Bekledingsvork, roestvast stalen blad



1479U/13 € 27,50 2 014790010

1479U/32

Bekledingsvork, roestvast stalen blad



1479U/32 € 34,50 2 014790015

1480

Assortiment voor het vullen van dieselolie filter van voertuigen zonder inschakeling van de elektrische pomp

• Eveneens te gebruiken met bandenvul pomp.

Assortiment bevat:

- GM snel koppeling
- Renault, GM, Fiat snel koppeling, binnen Ø 6 mm
- Renault, GM, Fiat snel koppeling, binnen Ø 7 mm
- Ford snel koppeling
- PSA snel koppeling, binnen Ø 6 mm
- PSA snel koppeling, binnen Ø 7 mm
- Ford snel koppeling
- 2 kegelvormige adapters voor voertuigen zonder snel koppeling



1480 € 432,00 1 014800010

410x320x70 mm

1481/C12

Kit van 6 paar slangklemtangen

Kit bevat:

- 2 paar verschillende klemmen maat 1/4"
- 2 paar verschillende klemmen maat 3/8"
- 2 paar verschillende klemmen maat 5/16"
- 3 paar rubber stoppen



1481/C12 € 139,50 1 014810312

370x270x59 mm

1481K/S4

4-delig set van zelfborgende klemmen voor het afdichten van leidingen

Maten:

5/16" - 3/8" - 1/2" en banjo



1481K/S4 € 35,50 1 014810400

1481PL/A

Slangklem

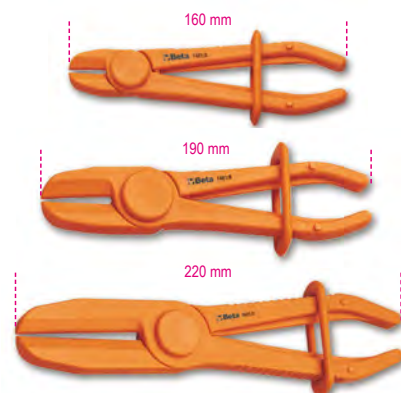

1481PL/A	Ø mm	€	1	014810110
1481PL/B	8÷15	22,50	3	014810120
1481PL/C	15÷25	25,00	3	014810130
	25÷45	34,50	3	014810130

1481PL/S3

3-delig set slangklemmen



1481PL/S3	€	1	014810200
1481PL-A Ø 8÷15 mm	82,00	1	014810200
1481PL-B Ø 15÷25 mm			
1481PL-C Ø 25÷45 mm			



1481T/C12

Set van afstoppluggen voor brandstofleiding

3 paar pluggen met man/vrouw aansluiting voor het afdichten van brandstofleidingen



1481T/C12	€ 144,50	1	014810212
≡ 275x220x45 mm - 540 g			

1482

Verstelbare en zelfklemmende sleutel voor tank borgringen



∅ mm	€		
89÷170	115,50	1	014820001
89÷200	122,50	1	014820002

1482A/1

3-armige sleutel voor tankborgringen, met een aluminium borgring

Voor het werken op de aluminium borgring welke zijn gemonteerd op voertuigen van Fiat, Volkswagen, Opel, Chevrolet, Mercedes en BMW sinds 2011



∅ mm	€		
185	81,00	1	014820005

1482A/3

Sleutel voor tankborgringen, PSA groep

Zo ontworpen, dat het mogelijk is om te werken op de gedecentraliseerde as door het verwijderen van de borgring, zonder de delicate brandstofleiding te beschadigen



∅ mm	€		
157	92,00	1	014820007

1482A/5

Sleutel voor tankborgringen, 22 grijppunten

Voor het gebruik op kunststof ringen bij voertuigen uit de VAG groep



∅ mm	€		
180	81,50	1	014820015

1482/8 - 1482/10

Brandstofleidingtang



∅ mm	€		
1482/8	43,50	2	014820008
1482/10	43,50	2	014820010

1482B

Tang voor snelkoppelingen van brandstofleidingen



1482B	€ 56,00	1	014820021
-------	---------	---	-----------

1482SN

Brandstofleiding tang, met beweegbare bekken



L mm	€		
260	67,00	1	014820110

1482C

Wiggen (2 paar) voor het loshalen van dieselfilters, Fiat, Volkswagen, Jeep, Chrysler en Volvo groepen

Het snel vervangen van het filter zonder het onherstelbaar beschadigen van de koppelingen



1482C	€ 70,50	1	014820022
-------	---------	---	-----------

1482D

Tang voor snelkoppeling van brandstofleiding, met flexibele verlenging



1482D	€ 96,00	1	014820026
-------	---------	---	-----------

1483K/12

Set voor het verwijderen van kleppen bij air-condition systeem compleet met 7 delig sets 5 punts bits

Set bevat:
• 2 open achthoekige dopsleutels, ∅ 12 en 15 mm, voor hoge druk kleppen
• 2 insteek dopsleutels, uitvoering 2.2 en 3.2 mm, voor gaskleppen
• 7 delig set 5 punts bits:
PT10, PT15, PT20, PT25, PT27, PT30, PT40



1483K/12	€ 45,00	1	014830012
----------	---------	---	-----------

≡ 120x80x35 mm

1483KV-PT/S7

7-delig set vijf punts bits

Bevat de volgende maten:
PT10 - PT15 - PT20 - PT25 - PT27 - PT30 - PT40



1483KV PT/S7	€ 13,50	1	014830117
--------------	---------	---	-----------

1483K/22

Assortiment ontkoppelgereedschappen voor koppelingen bij air-conditioning, brandstofvoeder en olie systemen.



1483K/22 € 160,00 1 014830022
300x230x55 mm - 1 kg

1484

2-delig set gereedschappen voor het verwijderen en monteren van V snaren
Maakt het mogelijk de V snaar eenvoudig te verwijderen of te plaatsen zonder deze te beschadigen



1484 € 136,00 1 014840010

1484PSA

Gereedschap voor het monteren van de v snaar van de waterpomp zonder v snaar voorspanner
Voor het gebruik op PSA en Opel groep voertuigen motoren 1.0 - 1.2



1484PSA € 18,40 1 014840012

1485BP

Halve maan blokkeer sleutel voor het fixeren van getande poelies

Instelbaar door de draaibare handgreep, spant en blokkeert de poelie aan de buitenkant en voorkomt hiermee dat de omliggende sensoren kunnen beschadigen



A Max mm 130 € 268,00 1 014850000

1485BPM

Halve maan blokkeer sleutel met aluminium uiteinden voor het fixeren van multi sleuf poelies

Instelbaar door de draaibare handgreep, spant en blokkeert de poelie van de buitenzijde en voorkomt hiermee dat de omliggende sensoren kunnen beschadigen



A Max mm 180 € 226,50 1 014850002

1485FCA/K2

Sleutels voor het voorspannen van lagers van de distributiepoelie, paar, FCA groep

Aanbevolen voor 1.2, 1.4 8/16 V en 1.4 Multiair motoren

- 1 175-mm-lange sleutel met 13.5-mm-diepe drukpen
- 1 305-mm-lange gecombineerde sleutel met 13.5-mm-diep drukpen



1485FCA/K2 € 123,00 1 014850220

1485FCA/T

Sleutels voor het voorspannen van de spanrol, lange uitvoering, met 13.5 mm drukpen



L mm 175 P mm 13,3 € 45,00 1 014850210

1485FCA/TS

Sleutels voor het aanspannen van de spanrol, geleed, met 13.5 mm drukpen



L mm 305 P mm 13,5 € 78,00 1 014850215

1485FRD/T

Hefboom voor het ontspannen van multi V snaar gemonteerd op Ford motoren
Ook te gebruiken bij de poelie van de dynamo



L mm 450 Q mm 12,80 € 95,00 1 014850310

1485MRC/T

Hefboom voor het voorspannen van riemen gemonteerd op Mercedes motoren
Voor het gebruik op motoren M133 - M270

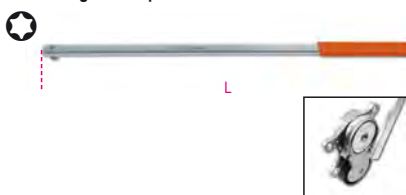

L mm 510 O T55 € 38,00 1 014850315

1485VLV/T

Hefboom voor het voorspannen van riemen gemonteerd op Volvo motoren

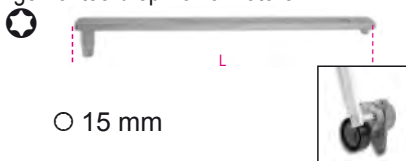

L mm 420 O T50-T60 O mm 15 € 77,50 1 014850320

1485TC

Hefboom voor multiriem spanner, gemonteerd op Ford, PSA, FCA motoren

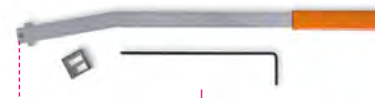

L mm 475 € 56,50 1 014850330

1485/KIT

Kit voor het controleren van de spanning van de distributieriem



1485/KIT € 210,00 1 014850100
230x140x75 mm - 580 g

1485MJ

Nokkenas blokkeersleutel, voor 1.3 16V Multijet motoren

2 3-vormige koppen voor het werken op alle 1.3 16V Multijet motoren van FCA, Opel, Ford en Suzuki groep voertuigen

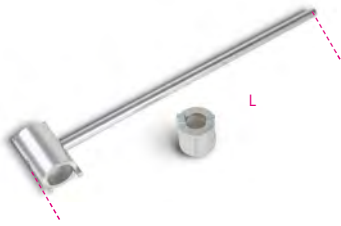

1485MJ	L mm 500	€ 154,00	1	014850150
--------	----------------	-------------	---	-----------

1485PMTJ

Voor het loshalen van de krukas poelie bij Multijet motoren

Specifiek ontworpen om de krukas te fixeren bij het loshalen van de poelie



1485PMTJ	L mm 450	€ 149,00	1	014850190
----------	----------------	-------------	---	-----------

1485R

Universele sleutel voor het draaien van de nokkenas poelie



30±120	Ø1 mm 10 - 17	L mm 500	€ 178,00	1	014850025
--------	---------------------	----------------	-------------	---	-----------

1485R/P10

Set inzetstukken



1485R/P10	€ 18,20	1	014850035
-----------	------------	---	-----------

1485R/P17

Set inzetstukken



1485R/P17	€ 18,20	1	014850038
-----------	------------	---	-----------

1485VAG/K2

Sleutels voor het voorspannen distributie lagere, paar

- 3-posities draaibare kop
- 1 sleutel met 12.5-mm -diepe aansluiting
- 1 sleutel met 21.5-mm-diepe aansluiting



1485VAG/K2	€ 94,50	1	014850080
------------	------------	---	-----------

1485VAG

Sleutels voor het voorspannen van lagere van de distributie poelie

- 3-posities draaibare kop



1485VAG/12,5	L mm 190	P mm 12,5	€ 46,50	1	014850062
1485VAG/21,5	L mm 195	P mm 21,5	€ 47,50	1	014850071

1487/K2

2 dopsleutels voor radiator aftappluggen



1487/K2	€ 31,50	1	014870100
---------	------------	---	-----------

1488 - 1488L

Oliefiltersleutel met ketting



1488	Ø mm 60±110	€ 104,00	1	014880001
1488L	Ø mm 60±160	€ 113,00	1	014880050

1488/1

Oliefiltersleutel met ketting



1488/1	Ø mm 60±110	€ 119,00	1	014880010
--------	-------------------	-------------	---	-----------

1488R...

Reserve ketting



1488RC	1488	350	€ 41,50	1	014880101
1488R/L	1488/L	520	€ 67,50	1	014880150
1488RC/1	1488/1		€ 57,00	1	014880110

1489/31T

Sleutel voor vliegwielen van dynamo



1489/31T	T50	15	31	€ 43,50	1	014890016
----------	-----	----	----	------------	---	-----------

1489/33

Trekker voor vliegwielen

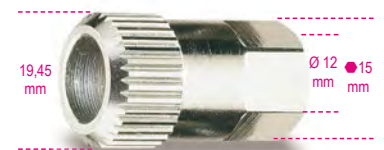

1489/33	33	€ 17,80	1	014890010
---------	----	------------	---	-----------

1489/33P

Sleutel voor dynamovliegwiël, voor Bosch FIAT Grande Punto dynamo's



M	mm	€		
10	15	55,50	1	014890015

1489/E

Sleutel voor vliegwielen van dynamo



mm	mm	€		
10	15	37,00	1	014890025

1489R

Sleutel voor dynamo vliegwiël

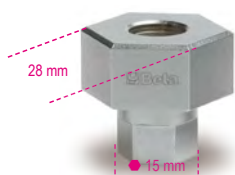

1489/R	€			
	18,10	1	014890020	

1489/Y

Sleutel voor dynamovliegwiël, voor Nippondenso dynamo's. I.c.m dopsleutels 910XZN/L en 920XZN/L en 920PEL



mm	€			
32	21,00	1	014890040	

1489/C14

14-delig assortiment gereedschappen voor dynamo vliegwielen



1489/C14	€			
	341,00	1	014890100	

- 867PE 8 mm
- 867PE/L 8 mm
- 867XZN/L M10
- 867TX/L T50
- 867/2 □1/2"
- 920B 10 mm
- 1489/33
- 1489/33P M10
- 1489R
- 1489Y
- 1489/31T T50
- 1489/E 10 mm
- 188 10 mm
- 188 15 mm

420x250x45 mm - 1,9 kg

1490

Oliefiltersleutel met canvasband

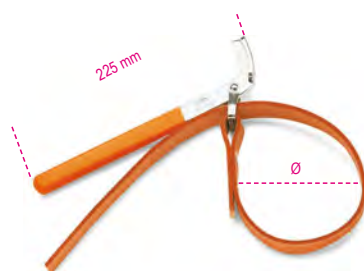

	Ø max mm	€		
1490/1	160	42,50	1	014900001
1490/2	240	45,00	1	014900002

1490/R1 - 1490/R2

Reserve spanband voor artikel 1490



	Ø mm	€		
1490R/1	160	21,50	1	014900101
1490R/2	240	25,50	1	014900102

1490F

Bandsleutel voor oliefilters



Ø Max mm	€			
200	50	32,00	1	014900201

1491

Oliefiltersleutel, verstelbaar



Ø mm	€			
65÷110	55,00	2	014910001	

1491R

Reserve metalen band voor model 1491



1491R	€			
	9,60	10	014910010	

1491A

Instelbare oliefiltertang

Nauwkeurige afstelling door opgelegd scharnier



L mm	Ø min - Max mm	€		
345	55 ÷ 140	36,50	1	014910040

1491T

Instelbare oliefiltertang voor vrachtautos

Nauwkeurige instelling door opgelegd scharnier
Te gebruiken op droogfilters



L mm	Ø min - Max mm	€		
500	70÷200	88,50	1	014910050

Beta

1492/1 - 1492/2

Oliefiltersleutels

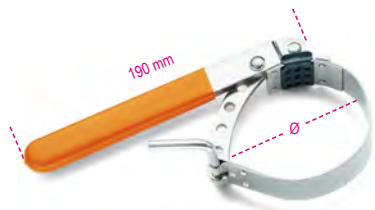

	Ø mm	€		
1492/1	60÷80	49,50	1	014920001
1492/2	80÷110	52,00	1	014920002

1492T

Luchtdroger filtertang



	Ø mm	H mm	€		
1492T 40	125÷145	40	38,50	1	014920540
1492T 75	120÷140	75	68,50	1	014920575

1493B

Twaalfkant platte oliefilter sleutels voor moeilijk te bereiken oliefilter



mm	± mm	€		
24	8	23,60	1	014930524
27	8	25,00	1	014930527
32	8	25,50	1	014930532
36	8	26,50	1	014930536
38	8	27,00	1	014930538

1493B/S5

5-delig set van twaalfkant oliefiltersleutels voor moeilijk te bereiken oliefilters

Afmetingen:
24-27-32-36-38 mm



1493B/S5	€		
	96,50	1	014930599

1493

Oliefilter dopsleutel

12"



Ø mm	N	€		
65	14	12,00	1	014930200
73	14	12,00	1	014930208
74	14	12,00	1	014930209
74	15	12,00	1	014930210
76	14	12,00	1	014930218
76-74	15	13,00	1	014930220
78	15	13,00	1	014930224
80	15	13,60	1	014930226
82-80	15	13,60	1	014930228
86	16	14,60	1	014930230
90	15	14,60	1	014930234
92	10	14,60	1	014930236
93	15	14,60	1	014930238
100	15	16,40	1	014930248
106	15	17,10	1	014930250
108	15	17,10	1	014930252
135	18	27,00	1	014930256

1493/PF

Purflux® oliefilter dopsleutel

12"



Ø mm	N	€		
66	6	12,00	1	014930202
76	12	12,00	1	014930216
76	30	13,00	1	014930222
86	18	14,60	1	014930232
93	36	14,60	1	014930240
93	45	14,60	1	014930242
96	18	14,60	1	014930246
108	18	17,80	1	014930254



1493/C30

28-delig set oliefilter dopsleutels

12"



Het assortiment omvat de maten (Ø mm / n°, aantal kanten) 1493:

65/14 - 67/14 - 68/14 - 73/14 - 74/15
76/15 - 75.77/15 - 76/14 - 76/8 - 78/15 - 80/15
82/15 - 86/16 - 90/15 - 92/10 - 93/15 - 95/15
100/15 - 106/15 - 108/15

1493PF (Purflux)
66/6 - 76/12 - 76/30 - 86/18
93/36 - 93/45 - 96/18 - 108/18

- Inclusief 1 instelbare oliefilter sleutel
Ø 65÷120 mm

1493/C30	€		
	299,00	1	014930000

530x400x110 mm - 4 kg

1493AL

Oliefilter dopsleutels.

N= aantal kanten

38"

12"

Hexagon icon



Ø mm	N	•	□	€		
64	14	27	1/2"	18,70	1	014930310
66,5	14	27	1/2"	16,90	1	014930315
74	14	27	1/2"	20,50	1	014930320
79	15	27	3/8"	18,70	1	014930325
84	14	27	3/8"	20,20	1	014930330
87	16	27	1/2"	24,80	1	014930335
92	15	27	3/8"	20,50	1	014930340
100,5	15	27	3/8"	20,50	1	014930350

1493AL 4S

Oliefilter dopsleutels voor Aziatische wagens

4-haak profiel

38"

Hexagon icon

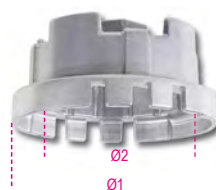

Ø1 mm	Ø2 mm	€		
70	64,5	27	20,30	1 014930304
80	64,5	27	18,70	1 014930305

1493AL CF

Zeskant dopsleutels voor oliefilterhouders



Ø mm	H mm	€	1	014930424
24	34	11,90	1	014930424
30	34	11,90	1	014930430
32,5	34	12,80	1	014930432
36	34	12,80	1	014930436
38	34	12,80	1	014930438

1493/C19

18-delig set oliefilter doppen, voornamelijk geschikt voor Aziatische auto's

Ø mm	N°. van hoeken
63-64	14
66.5	14
74	14
79	15
84	14
87	16
92	15
94.5	15
100.5	15
64.5	14 haak dop voor Toyota auto's
64.5	14 haak dop voor Lexus auto's
6 zeskant dopsleutels, maten 24-27-30-32.5-36-38 mm, voor filterhouders	
Set bevat 1 universele en instelbare dop Ø 58÷93 mm	



1493/C19 € 269,00 1 014930019
490x450x60 mm - 4 kg

1493DSG

Oliefilter sleutel voor het verwijderen en installeren van een DSG olie filter



Ø mm 24 € 42,00 1 014930800

1493FF

Gebogen sleutel voor het verwijderen of monteren van de kunststofhouder bij Ford Peugeot Citroën olie filters
Motoren: TDCi-HDi
Maakt het mogelijk de kunststof houder correct te monteren tot 25 Nm met behulp van een momentsleutel



Ø mm 27 € 34,00 1 014930127

1493FT

Oliefilter sleutel voor Ford Transit Diesel

Is te gebruiken voor alle Transit, Transit Custom en Tourneo Custom uitvoeringen welke gefabriceerd zijn sinds 2012



Ø mm 115 € 28,00 1 014930085

1493J

Oliefiltersleutel voor MultiJet

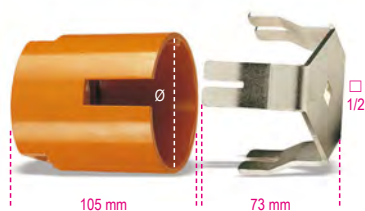

Ø mm 90 € 139,00 1 014930080

1493VW

Diesel oliefilter sleutel, voor VAG en Volvo automobielen



Ø mm 82,5 € 19,20 1 014930086

1493HK

Dieselolie filtersleutel voor Hyundai Kia, 15-punts



1493HK € 31,50 1 014930087

1493/C7

Zelfspannende oliefilter sleutel met 3 grijppunten voor links en rechtop vastdraaien, met vervangbare grijpers

antislip diamanten afwerking
2 sets van grijpers:
• 1 set met 20 mm werkhoopte
• 1 set met 38 mm werkhoopte



Ø mm 50÷100 € 132,00 1 014930079
Ø mm 16
210x150x50 mm

1493H

Zelfspannende oliefilter sleutel met 3 grijppunten, voor het rechts en linksom vastdraaien
Gegroefde grijppunten

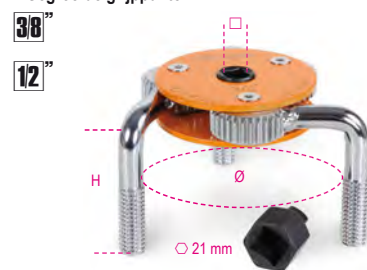

Ø mm 72÷127 € 31,50 1 014930077
H mm 62



1493/S-U

Zelfklemmende oliefiltersleutel, 3- armen voor links en rechts aandraaien



	□	∅ mm	€		
1493/S	3/8-1/2	80-115	97,00	1	014930074
1493/U	1/2	105-165	207,50	1	014930076

1493X

Zelfspannende oliefilter sleutels, voor linksom vastdraaien

38"



	∅ mm	± mm	€		
1493X/1	60÷80	2,9	36,00	1	014930105
1493X/2	80÷98	2,9	36,00	1	014930110

1493Y

Zelfspannende oliefilter sleutel, voor het links en rechtsom vastdraaien, zware uitvoering

Artikel 1493Y/2 is eveneens te gebruiken voor lucht filters

12"



	∅ mm	± mm	€		
1493Y/1	80÷110	7,3	132,00	1	014930120
1493Y/2	104÷145	7,3	200,50	1	014930122

1493C/ADB

Speciale dopsleutels voor het opendraaien van AdBlue® pluggen, voor voertuigen uit de PSA groep

38"



1493C/ADB	17 mm	€	17,20	1	014930900
-----------	-------	---	-------	---	-----------

1493U/ADB

Dopsleutel voor het opendraaien van AdBlue® aftappluggen

38"



1493U/ADB	17 mm	€	12,50	1	014930910
-----------	-------	---	-------	---	-----------

1494T/C5

Set van speciale sleutels voor kunststof oliepluggen

Set omvat:

- 1 dopsleutel voor VAG groep carterpluggen
- 1 dopsleutel voor BMW carterpluggen
- 1 dopsleutel voor PSA en Ford groep carterpluggen
- 1 dopsleutel voor Mercedes carterpluggen
- 1 "T"-greep sleutel

38"



1494T/C5	17 mm	€	81,00	1	014940350
----------	-------	---	-------	---	-----------

173x125x50 mm - 360 g

1494BMW

Speciale adapters voor kunststof oliecarter pluggen, voor BMW motoren

38"



1494BMW	17 mm	€	15,40	1	014940315
---------	-------	---	-------	---	-----------

1494FPC

Speciale adapters voor kunststof oliecarter pluggen, voor Ford, Peugeot en Citroën motoren

38"



1494FPC	17 mm	€	17,50	1	014940320
---------	-------	---	-------	---	-----------

1494VW

Speciale carterplug sleutel voor kunststof carterpluggen, bij Volkswagen motoren

Maakt het mogelijk de kunststof carterplug te monteren en te demonteren bij de oliecarter.

Speciaal ontworpen voor Volkswagen voertuigen met TFSI en TDI motoren

38"



1494VW	17 mm	€	24,90	1	014940305
--------	-------	---	-------	---	-----------

1494MRC

Speciale sleutel voor kunststof carterplug, voor Mercedes motoren

38"



1494MRC	17 mm	€	17,40	1	014940325
---------	-------	---	-------	---	-----------

1494MAN

Speciale sleutel voor kunststof carterplug, voor DAF en MAN motoren

38"



1494MAN	17 mm	€	17,40	1	014940330
---------	-------	---	-------	---	-----------

1494

Vierkant carterplug bit

12"



mm	€		
10	10,20	1	014940280

1494E

Zeskant carterplug dopsleutel

12"



mm	€		
8	10,20	1	014940208
9	10,20	1	014940209
10	10,20	1	014940210
11	10,20	1	014940211
12	10,20	1	014940212
14	10,20	1	014940214
17	10,20	1	014940217



1494Q

Vierkant carterplug dopsleutel



12"



mm	€	1	014940258
8	10,20	1	014940258
9,5	10,20	1	014940259
12	10,20	1	014940262
13	10,20	1	014940263

1494T

Driekant carterplug dopsleutel



12"



mm	€	1	014940289
9,5	10,20	1	014940289

1494XZN

Carterplug dopsleutel met XZN® profiel



12"



M	€	1	014940296
16	12,30	1	014940296

1494VW/K

Carterplug service set, voor VAG automobielen



Set bevat:

- 1 speciale bit dopsleutels voor kunststof oliecarter schroeven
- 6 kunststof carterpluggen

1494VW/K	€	1	014940310
	34,00	1	014940310

1494VW/KT

Set van 6 plastic doppen voor artikel 1494VW/K



1494VW/KT	€	1	014940311
	28,50	1	014940311

1494/C14A

14-delig set olie verwissel gereedschappen

12"



1494/C14A	€	1	014940150
	153,00	1	014940150

- 1494E 8-9-10-11-12-14-17
- 1494Q 8-9,5(3/8")-12-13
- 1494 10
- △ 1494T 9,5(3/8")
- 1494XZN M16

380x305x40 mm - 1,7 kg

1494M

Flexibele carterplugsleutel voor zeskant pluggen, magnetisch.

Maakt het mogelijk de plug los te schroeven zonder het risico van verbranding of vuil te worden.



L mm	F kg	Ø mm	€	1	014940401
293	2,5	19	26,50	1	014940401

1495/C6

Assortiment gereedschappen voor het herstellen van schroefdraad van oliecarterplug



- De beschadigde draad wordt opnieuw getapt en vervangen door een maat groter
- Maakt repareren mogelijk en voorkomt vervangen van de gehele carter

Bevat:

- 1 handtap M13x1.25 + 6 pluggen + 12 vulringen
- 1 handtap M13x1.5 + 6 pluggen + 12 vulringen
- 1 handtap M15x1.5 + 6 pluggen + 12 vulringen
- 1 handtap M17x1.5 + 6 pluggen + 12 vulringen
- 1 handtap M20x1.5 + 6 pluggen + 12 vulringen
- 1 handtap M22x1.5 + 6 pluggen + 12 vulringen

1495/C6	€	1	014950500
	336,00	1	014950500

420x185x60 mm - 2,1 kg

1495M

Draadtap voor carterplug draad



M	€	1	014950553
13x1,25	19,50	1	014950553
13x1,50	15,80	1	014950563
15x1,50	17,40	1	014950565
17x1,50	19,50	1	014950567
20x1,50	21,40	1	014950570
22x1,50	27,50	1	014950572

1495T

6-delig set carterpluggen en opvullingen



M	€	1	014950503
13x1,25	22,20	1	014950503
13x1,50	22,20	1	014950513
15x1,50	22,20	1	014950515
17x1,50	26,00	1	014950517
20x1,50	28,00	1	014950520
22x1,50	37,00	1	014950522

1496/C

Carterplugsleutels



8 x 10 mm	€	3	014960010
	25,00	3	014960010

1497D

Tang voor het verwijderen van relais blokken, recht model



A min+Max mm	€	1	014970150
15÷50	41,00	1	014970150

1497BS

Tang voor het verwijderen van relais en zekeringen, recht, dun model

de lange, extreem dunne punten zorgen ervoor dat het relais en de zekering uit kleine ruimtes kunnen worden verwijderd



L mm	L1 mm	A min	€		
230	45	14	26,00	1	014970190

1497P

Tang voor het verwijderen van relais blokken, 60° gebogen



1497P	A min+Max mm	€		
	15÷50	42,00	1	014970160

1497SS

soldeerfixeertang voor het solderen van vertinde draden

Bovenste clips maken het mogelijk om soldeerdraden vast te klemmen en dicht bij elkaar te brengen. Ingebouwde fixeerstand maakt het mogelijk om draden in 6 verschillende posities te plaatsen. De soldeertang kan gewoon worden neergelegd en zijn beide handen vrij voor het solderen.



L mm	A min+Max mm	€		
245	14÷70	24,00	1	014970195

1497TE

Tangen voor het loskoppelen van elektrische koppelingen

De extreem dunne beken maken het mogelijk de klemmen los te koppelen zonder hierbij de koppelingen te beschadigen



1497TE	L mm	A Max mm	Ø mm	€		
	215	63	4	27,00	1	014970180

1497/C23

23-delig assortiment voor het verwijderen van contacten uit stekkerblokken



1497/C23	€		
	259,00	1	014970200

440x250x70 mm - 1,7 kg

1497/C94

Assortiment van 94 auto elektronische aansluitingen voor het testen in combinatie met diagnose testapparatuur

- 2 t-aansluitingen
- 2 potentiometers
- 2 waarschuwingslampjes
- 2 SRS aansluitingen
- 2 kerkodillenbekken
- 2 naaldvormige sondens
- 2 steekpennen
- 2 dubbele banaan aansluitingen
- 4 enkele banaan aansluitingen
- 24 platte uitwendige clips 0.6÷6 mm
- 12 ronde uitwendige clips 1.6÷3.9 mm
- 24 platte inwendige clips 0.6÷6 mm
- 12 ronde inwendige clips 1.6÷3.9 mm



1497/C94	€		
	446,00	1	014970300

430x390x100 mm - 3 kg

1497RC

Doorsteekpennen, paar

- Kabeldikte: 1.5÷3.5 mm
- Volt: 0÷330V
- Max. stroom: 5A



1497RC	€		
	85,00	1	014970351

1497KB/S3

3-delig set gereedschappen voor het verwijderen van Knorr en Bremse elektrische koppelingen

- 1 Sleutel voor bajonet aansluiting
- 1 Sleutel met enkelvoudige kop voor 2 polige aansluiting
- 1 Sleutel met dubbele kop voor 4- of 6- en 12-polige aansluiting



1497KB/S3	€		
	95,00	1	014970050

1497/S3

3-delig set van kabels voor elektrische signaal detectie

- 1 Rechte pc.
- 1 45° pc.
- 1 90° pc.



1497/S3	€		
	22,30	1	014970400

1498

Spanningsmeter-voltage tester

CE

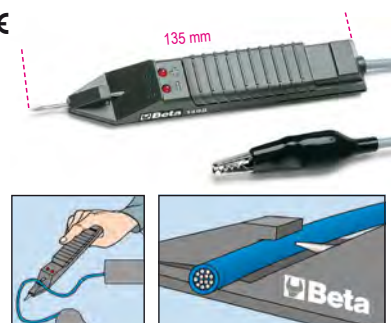

3÷48V	€		
	55,50	2	014980100



VOERTUIG REPARATIE

Onze reparatie gereedschappen voor voertuigen, die worden gebruikt door de meest veeleisende professionals, zijn ontwikkeld en vervaardigd om te voldoen aan de hoogste normen ter wereld en worden regelmatig getest onder de meest stressvolle bedrijfsomstandigheden. Al meer dan 50 jaar werken we met trots samen met de grootste kampioenen, die ons non-stop helpen onze producten te verbeteren en te bewijzen volgens de hoogste kwaliteitsnorm.

De voertuig reparatie gereedschappen zijn te vinden in deze secties:

Diagnose	artikel 1438 tot 1499 artikel 1758VT tot 1760TMC
Motor	artikel 955 tot 989A artikel 1438 tot 1499
Olie en filters	artikel 1438 tot 1499 artikel 1877 tot 1885
Elektrisch systeem	artikel 1438 tot 1499
Startboosters	artikel 1498BC/12 tot 1498/40A
Versnelling	artikel 1438 tot 1499
Ophanging	artikel 1549 tot 1569CP
Remmen	artikel 1438 tot 1499
Wielen	artikel 955 tot 989A
Carrosserie gereedschap	artikel 1302 tot 1369 artikel 1763 tot 1767A
Overig gereedschap	artikel 1875LT tot 3067
Garagekriks	artikel 3029/2T tot 3067/70-13T



1498BC/12

multifunctionele draagbare starter, 12V

Technische data:

- Startstroom: 600A
- Ophaalstroom: 1500A
- Batterijtype: 4 cellen, LifePo4
- Batterijcapaciteit: 25000mAh
- Apparaat beschermt tegen polariteitsomkering, kortsluiting, overstroom, overbelasting en oververhitting



Voorzien van:

- Beschermende hoes
- Kabel met startklemmen
- USB-poorten voor het opladen van elektronische apparaten
- LED-indicator voor batterijlading
- USB- en USB-C-kabel
- Netvoeding
- Multifunctionele LED-zaklamp

1498BC/12 L 225 mm P 100 mm H 40 mm € 349,00 1 014980040

1498MN/12-C

Startkabel met klemmen voor artikel 1498BC/12



1498MN/12-C € 61,50 1 014980005

1498MN/12-R

Lader voor mini startbooster 1498BC/12



1498MN/12-R € 45,00 1 014980003

1498MN/12-P

Lader met auto sigaret aansluiting voor mini starthulp 1498BC/12



1498MN/12-P € 27,50 1 014980004

1498MN/12-U

USB kabels met universele U adapter



1498MN/12-U € 20,00 1 014980009

1498LT/12

Draagbare krachtige startbooster, ultralicht



De microprocessor geeft een volledige bescherming tegen:

- Omschakeling polariteit
- Kortsluiting
- Onjuiste voltage
- Overbelasting
- Onvoldoende ontladen
- Overladen
- Te hoge temperatuur

TECHNISCHE SPECIFICATIES

Continue spanning: 12 V
Continue amperage: 800 A
Maximale piekspanning: 2000 A
Piek amperage: 4000 A
Kabellengte: 500 mm
Batterij type: 4-cel LifePo4
Auto geheugen beveiliging: JA
Afmetingen: 260 x 135 x 72 mm
Netto gewicht: 2.5 kg
Compleet met laad adaptor 12 V 1.3A

1498LT/12 € 880,00 1 014980012

1498LT/12-SF

Muur houder voor startbooster artikel 1498LT/12



1498LT/12-SF € 145,00 1 014980013

1498LT/12-R7

Hoofd voeding voor startbooster 1498LT/12



1498LT/12-R7 € 64,00 1 014980057

1498LT/12-24

Draagbare krachtige startbooster,
12-24 V, ultralicht

Geschikt voor het gebruik op wagens,
bedrijfsvoertuigen en vrachtautos



De microprocessor geeft een volledige bescherming tegen:

- Omkeering polariteit
- Kortsluiting
- Onjuiste voltage
- Overbelasting
- Onvoldoende ontladen
- Overbelasting
- Te hoge temperatuur

TECHNISCHE SPECIFICATIES

- Werkspanning: 12/24V
- Continue amperage: 2000/1000 A
- Maximale start amperage: 5000/2500 A
- Piek amperage: 10000/5000 A
- Klem amperage: 1000 A
- Kabel lengte: 160 cm
- Kabel sectie: 25mm²
- Automatische voeding: 4 Amp
- Geheugen beveiliging
- Afmetingen: 350x240x140 mm
- Gewicht: 5 kg

1498LT/12-24 € 1.755,00 1 014980014

1498/12

Startbooster, 12V



TECHNISCHE SPECIFICATIE:

- Piekspanning: 2200A
- Draagriem meegeleverd
- Verzegelde loodzuur batterij, solide electrolytisch (AGM) type

1498/12 € 775,00 1 014980480

13 kg

1498/24

Mobiele startbooster voor autos en
bedrijfsvoertuigen,
12-24V



TECHNISCHE SPECIFICATIE:

- Piekspanning stroom: 4200A (12V) - 2100A (24V)
- Draagriem meegeleverd
- Verzegelde loodzuur batterij, solide electrolytisch (AGM) type

1498/24 € 1.410,00 1 014980490

1498B12/R02

12V reserve batterij
voor startboosters 1498B/12 en 1498B/24



1498B/12-R02 € 315,00 1 014980502

1498/12-24 R20

Reserve batterij voor startboosters artikel
1498/12 en 1498/24



1498/12-24 R20 € 75,00 1 014980520

1498/2A

Electronische batterijlader voor wegmotoren,
12V

Maakt het laden mogelijk van alle
Pb Wet, Agm, Gel, Mf en Vrla batterij type
en LiFePo4 lithium batterijen



- Twee verschillende mogelijkheden tot laden, respectievelijk voor lithium en loodzuur houdende batterijen
- Automatische multi fase laad cycles
- Bescherming tegen omschakeling polariteit en kortsluiting
- IP65 beschermingsklasse
- Compleet met kabel en klemmen en kabel met oogaaansluiting
- Voeding: 220-240V

TECHNISCHE SPECIFICATIES

- Laadstroom: 1A
- Laadcapaciteit: 2Ah-40Ah
- Frequentie: 50-60 Hz
- Batterij voltage: 12V
- Afmetingen: 180x80x40 mm
- Gewicht: 0.5 kg

1498/2A € 153,00 1 014980102

1498/4A

Electronische batterijlader voor auto en
motorfietsen, 6-12V



- Bescherming tegen omschakeling polariteit en kortsluiting
- Automatisch 6 of 12 volt selectie
- Automatisch selectie type batterij
- Digitaal scherm met verlichting
- Uittrekbare ophanghaak

TECHNISCHE SPECIFICATIES Voeding voltage: 220V-240V

- Frequentie: 50-60 Hz
- Laadstroom (min-max): 1-4 Amp
- Batterij voltage: 6V/12V
- Batterij capaciteit: 4Ah-80Ah
- Laadduur: 12 uur
- Beschermingsklasse: IP65

1498/4A € 178,00 1 014980104

1498SA/2A-4A

Kabel met 12V sigarette aansteek plug
voor artikelen 1498/2A en 1498/4A



1498SA/2A-4A € 38,50 1 014980120



1498/8A

Electronische batterijlader voor auto en bedrijfsvoertuigen, 12V



- Langzaam en snel laden (2A-8A)
- Lege accu herstellfunctie
- 13.8V-5A stroom afgifte functie
- Beschermd tegen omschakeling polariteit en kortsluiting
- Handmatige selectie batterij type
- Digitaal scherm met verlichting
- Uittrekbare ophanghaak

TECHNISCHE SPECIFICATIES

Voeding voltage: 220V - 240V
Frequentie: 50-60 Hz
Laadstroom (min-max): 2-8 Amp
Batterij voltage: 12V
Batterij capaciteit: 5Ah-160Ah
Memory saving toepassing: 13.8V - 5A
Beschermingsklasse: IP65

1498/8A € 252,00 1 014980108

1498/4A-8A CO

Kabel met oogaansluiting voor artikel 1498/4A en 8A



1498/4A-8A-CO € 18,50 1 014980114

1498/4A-8A CP

Kabel met klemaansluiting voor artikel 1498/4A en 8A



1498/4A-8A-CP € 24,90 1 014980118

1498/2A-8A-PR

Verlenging voor artikel 1498/2A/4A/8A



1498/2A-8A-PR € 44,00 1 014980119

1498/16A

Elektronische multifunctionele acculader, 12-24V



- Grafische weergave op verlicht scherm
- Max.laadspanning: 16A, continue
- Laden en onderhoud
- Bescherming tegen ompoling en kortsluiting
- 9 laadfasen
- Onderhoudslader
- SHOW ROOM functie (13.8V - 12A)
- VOEDING functie (14V - 12A)
- Geheugen bescherming functie (13.8V - 12A)
- Accu herstel functie
- Klemhouder
- Uittrekbare ophandhaak
- Geleverd met toebehoren: kabel met klem, kabel met oog

TECHNISCHE GEGEVENS

Voeding: 220-240V
Vermogen: 240W
Laadstroom: 4-16A
Geschikt voor accu type: Agm - Wet - Lithium (LiFePo4)
Laad capaciteit: 5-360Ah
Onderhoud capaciteit: 5-550Ah
Geschikt voor accu: 12-24V
Minimum accu spanning: 0.8V
Beschermingsklasse: IP20

1498/16A € 522,00 1 014980126

1498/25A

Elektronische multifunctionele batterijlader, 12-24V



Kenmerken:

- Verlicht grafisch display
- Maximale continue oplaadstroom: 25a
- Opladen en onderhoud
- Beschermd tegen polariteitsomkeer, korte circuits
- 9 oplaadfasen
- 'Drijvend' systeem
- Demo-functie (13,8v - 21a)
- Leveringsfunctie (14V - 21A)
- Geheugenbesparende functie (13.8V - 21A)
- Functie voor batterijherstel
- Klemhouder
- Liggende bevestigingshaak
- Geleverde accessoires: kabel met klem

Technische data:

- Voeding: 220-240V
- POWER: 390W
- Laadstroom: 5-25A
- Batterijtype: AGM - Nat - Lithium (LIFEPO4)
- Oplaadcapaciteit: 5-550AH
- Onderhoudscapaciteit: 5-800AH
- Uitgangsspanning: 12-24V
- Minimale batterijspanning: 0.8V
- Beschermingsgraad: IP20

1498/25A L mm H mm P mm € 623,00 1 014980125

1498/120A

Elektronische multifunctionele accu lader,
12 V

Maakt het mogelijk accu's te laden
en voorziet het motorvoertuig van stroom tijdens diagnose
werkzaamheden



- Maximale continue laadspanning: 120A
- Laden en onderhoud gecontroleerd met CPU microprocessor
- Accu herstel functie na diepe ontlading
- Her programmeren en voedingsstroom voor ECU
- Bescherming tegen ompoling, kortsluiting, onjuiste spanning en overbelasting

TECHNISCHE KENMERKEN

Voeding: 90-260V
Vermogen: 1500W
Laadstroom: 10-120A
Geschikt voor accu type: Agm - Wet - Lithium (LifePo4)
Laad capaciteit: 10-1200Ah
Onderhouds capaciteit: 5-3600Ah
Geschikt voor accu: 12 Volt
Lengte kabel, met klemmen: 2700 mm
Afmetingen: 310 x 150 x 350 mm
Gewicht: 8.5 kg

1498/120A € 3.300,00 1 014980142

1498/40A

Multifunctionele startbooster en lader, 12-24V
verrijdbaar



- 3 voorgeprogrammeerde laad cycli en 1 handmatige
- Electronische instelbare potentiometer
- Specifieke WET-SPIRAL/GEL-AGM laad cycli
- Electronisch controle en beschermingssysteem
- 10-traps laadproces
- Batterij desulfateren en herstellfunctie
- Voeding functie
- Dubbele voltage, 12-24V
- Tevens geschikt voor Start&Stop batterijen
- Professionele rubber-geïsoleerde koperen klemmen

TECHNISCHE SPECIFICATIES

Voeding: 230V
Spanning: 12-24V
Laadstroom: 1-40A
Startstroom: 350A max cc
Laadcapaciteit: 4-450Ah

1498/40A € 1.330,00 1 014980140
330x250x792

1498SM

Autogeheugen beveiliging, 12 V

Vorkomt data verlies vanuit het geheugen van de
autocomputer bij het vervangen van de accu of tijdens
onderhoud.



- Technische specificaties:
- zelf voedende interne batterij Pb 5 Ah
 - 12 volts
 - professionele aansluiting met OBD stekker

1498SM € 282,00 1 014980020

1498SM-C

OBD II autogeheugen beveiliging stekkers,
12V, voor artikel 1498SM/C



1498SM-C € 31,50 1 014980021

1498SM-CP

Autogeheugen beveiliging aansluitingen, 12V
klem, voor artikel 1498SM/CP



1498SM-CP € 30,00 1 014980022

1498SM-A

Lader voor autogeheugen beveiliging artikel
1498SM/A



1498SM-A € 33,50 1 014980023

1498TB/6-12

Analoge batterijtester, 6-12v

Voor het testen van 6V- en 12V-batterijen tot 1000cca



Kabellengte: 500 mm

1498TB/6-12 € 67,00 1 014980420
L L1 P
mm mm mm

Beta

1498TB/12-24

Digitale accu tester, 12V, en controleerd het start en laad systeem, 12-24V

- Maakt het mogelijk het volgende te testen: accu, dynamo (smart en normaal) en starter, diode rimpel en aardig systeem
- Voorzien van software voor het printen van de test via de PC
- Scherm met achtergrond verlichting
- Compact, schokbestendige behu



CE

TECHNISCHE KENMERKEN:

- Toepassingen: 12V accu test - Dynamo laad test, 12-24V - Start systeem test
- Werk bereik: 100-2000 CCA
- Referentie standaards: CCA, SAE, DIN, EN, IEC, JIS
- Geschikt voor accu type: PB, WET, GEL, AGM, AGM FLAT, EFB
- Voltmeter: 9V-36V
- Lengte kabel: 1600 mm
- Talen: Italiaans, Engels, Frans, Duits, Spaans, Pools, Romeens, Nederlands, Zweed en Fins
- Toebehoren meegeleverd: USB kabel en software

1498TB/12-24 € 725,00 1 014980401

1498ST/TB

Mini thermische printer voor testapparaat artikel 1498TB/12

- Mini printer kan rechtstreeks aan het testapparaat aangesloten worden
- Maakt het mogelijk de testresultaten uit te printen



CE

1498ST/TB € 275,00 1 014980410

1498ST/TB ROT

Papierrol voor printer 1498ST/TB



1498ST/TB ROT € 12,50 2 014980411

1498PC

Spannings stabilisator, 12-24 V

Beschermde controle units tijdens het lassen en startprocedures



1498PC € 114,50 1 014980801

1499

Stethoscoop



1499 € 117,00 1 014990001

1500/...

Twee-armige trekkers

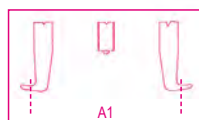

	L mm	€		
1500/1	100	94,00	1	015000301
1500/2	100	98,50	1	015000302
1500/3	150	166,00	1	015000303
1500/4	150	231,50	1	015000304
1500/5	205	415,00	1	015000305
1500/6	205	482,00	1	015000306
1500/7	205	732,00	1	015000307
1500/8	230	1.165,00	1	015000308

	A min+Max mm	A1 min+Max mm
1500/1	25÷80	70÷130
1500/2	25÷130	80÷180
1500/3	50÷160	105÷220
1500/4	60÷200	120÷270
1500/5	80÷250	160÷330
1500/6	80÷350	160÷420
1500/7	110÷520	195÷600
1500/8	170÷640	260÷715



Beta



1500/SP5 € 1.070,00 1 015000325
 1500/1-1500/2-1500/3
 1500/4-1500/5
 1500/SPV € 90,00 1 015000001

1500G/...

Armen, per paar, standaard uitvoering, voor items 1500 en 1580/8I



	mm	1500	€		
1500G/1	35	/1-2	62,00	1	015000311
1500G/3	35	/3-4	90,50	1	015000313
1500G/5	35	/5-6-7	186,00	1	015000315
1500G/8	50	/8	227,00	1	015000317

1580/8I

1500N/...

Twee-armige trekkers

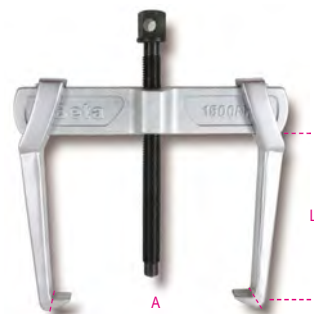

	A min+Max mm	L mm	€		
1500N/0	18÷65	70	88,00	1	015000600
1500N/1	23÷70	100	91,50	1	015000601
1500N/2	23÷100	100	96,00	1	015000602
1500N/3	35÷140	150	159,50	1	015000603
1500N/4	35÷190	150	171,50	1	015000604
1500N/5	43÷250	205	338,00	1	015000605
1500N/6	43÷320	205	365,00	1	015000606



1500N/SP6	€ 944,00	1	015000626
1500N/0-1500N/1-1500N/2-1500N/3			
1500N/4-1500N/5			
1500N/SPV	€ 110,00	1	015000006

1500N/G...

Losse armen voor model 1500N



	mm	1500N	€		
1500N/G0	10	/0	28,50	2	015000650
1500N/G1-2	12	/1-2	31,00	2	015000651
1500N/G3-4	17	/3-4	53,00	2	015000653
1500N/G5-6	23	/5-6	100,00	2	015000655

1501/1 - 2 - 3

Trekkers met dunne armen

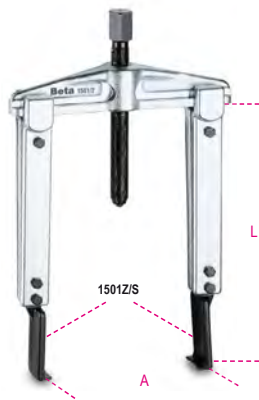

L	mm	€		
1501/1	100	226,50	1	015010101
1501/2	200	238,00	1	015010102
1501/3	250	249,50	1	015010103

A	min+Max
1501/1	25÷130
1501/2	25÷130
1501/3	25÷130



1501G/1 - 2 - 3

Losse armen voor model 1501



L	mm	€		
1501G/1	100	124,50	1	015010111
1501G/2	200	146,00	1	015010112
1501G/3	250	157,50	1	015010113

1501Z/S - P - R

Losse uiteinden voor model 1501G



	mm	D	mm	€		
1501Z/S	2,0	27		44,50	2	015010211
1501Z/P	3,6	27		45,00	2	015010212
1501Z/R	3,6	14		50,50	2	015010213

1502/...

Twee armige universele trekkers met snelspan instelling en borging van de armen

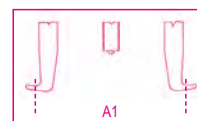
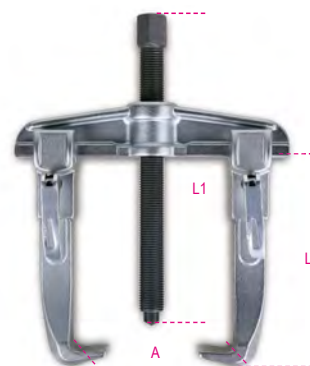

	L	L1	€		
1502/0	100	166	143,50	1	015020000
1502/1	100	166	157,00	1	015020001
1502/2	150	247	248,50	1	015020002
1502/3	150	247	275,00	1	015020003
1502/4	200	321	474,00	1	015020004

	A	A1
	min+Max	min+Max
	mm	mm
1502/0	40÷90	80÷130
1502/1	50÷130	90÷170
1502/2	65÷150	115÷210
1502/3	65÷190	125÷260
1502/4	70÷235	170÷335

1505V

Ruitenwisserarm trekker, zowel voor als achter ruitwisser

Afneembare geperforeerde koperen bekken voor het verwijderen van de arm met geïntegreerde spreikop



	A Max	L	€		
1505V	mm	mm	52,50	1	015050001

1505/C5

Ruitenwisserarm demonteerset

1 twee-armige trekker, Ø 25÷40 mm
4 halve-maanvormige trekkers, Ø 25 mm, Ø 30 mm, Ø 35 mm, Ø 41 mm



mm 12 € 165,50 1 015050300

320x150x60 mm - 1,2 kg

1506

Twee-armige zelfklemmende trekker

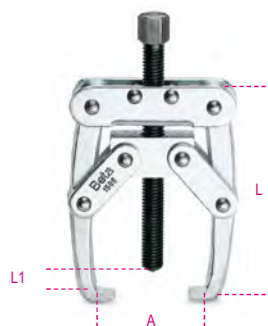

	A min+Max mm	L mm	L1 mm	€		
1506	10÷50	80	40	58,50	1	015060001

1508/1 - 1508/2

Twee-armige trekker, lichte uitvoering

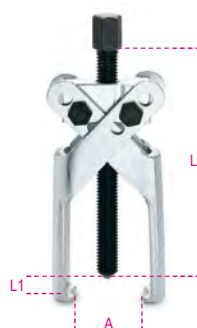

	L mm	€		
1508/1	105	178,00	1	015080001
1508/2	130	214,50	1	015080002

	A min+Max mm	L1 mm
1508/1	6÷100	85
1508/2	10÷140	120

1511/1 - 2 - 3

Buiten trekkers met omkeerbare armen

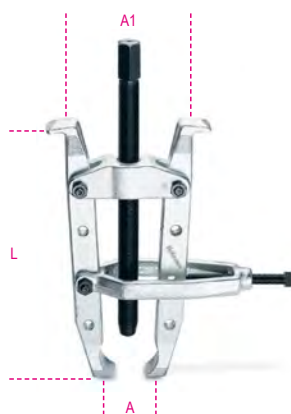

	L mm	€		
1511/1	235	310,00	1	015110001
1511/2	330	385,00	1	015110002
1511/3	405	475,00	1	015110003

	A min+Max mm	A1 min+Max mm
1511/1	20÷100	65÷95
1511/2	40÷150	103÷190
1511/3	40÷150	103÷175

1515/1 - 2 - 3

Twee-armige trekkers



	L mm	€		
1515/1	85	42,00	1	015150101
1515/2	85	44,50	1	015150102
1515/3	105	65,00	1	015150103

	A Max mm	L1 mm
1515/1	60	105
1515/2	70	105
1515/3	90	105

1516/1 - 2 - 3

Drie-armige trekkers



	L mm	€		
1516/1	85	61,50	1	015160001
1516/2	85	66,50	1	015160002
1516/3	105	93,50	1	015160003

	A Max mm	L1 mm
1516/1	60	85
1516/2	70	85
1516/3	90	105

1517

Drie-armige zelfspannende trekker

- Voor aanzienlijke trekspanning.
- Zelfspannende werking.

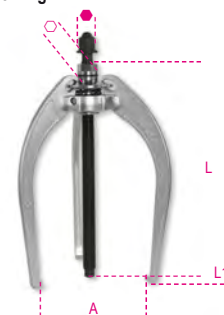

	L mm	L1 mm	Ø mm	€		
1517/90	182	60	22	308,00	1	015170000
1517/150	242	115	22	322,00	1	015170010
1517/200	307	150	22	357,00	1	015170020
1517/260	395	180	30	415,00	1	015170030

	● mm	A mm	kg	N
1517/90	19	18÷90	6000	59000
1517/150	19	25÷150	6000	59000
1517/200	19	40÷200	6000	59000
1517/260	27	50÷260	8000	78500



1517C TWEË / DRIE-ARMIGE ZELFSPANNENDE TREKKERS VOOR EXTERN GEBRUIK

Beta's trekker 1517C is gebaseerd op een zelf vergrendelend armmechisme dat wordt geactiveerd door de veer op het trekkerhuis. Deze functie maakt het gemakkelijk om de trekker op het te verwijderen onderdeel te plaatsen en te vergrendelen. Nadat de trekker is vastgezet, kunnen de poten worden vergrendeld door middel van de ringmoer.

Het specifieke trekkerhuis heeft 4 positie zittingen waardoor de 1517C-trekker met beide 2 armen kan worden gebruikt - voor gemakkelijkere, snellere klussen - en 3 armen - voor meer stevigheid.

De borgpen op de schroefkop breekt wanneer het maximale toegestane koppel wordt overschreden en beschermt zo de trekker tegen overbelasting.

1517C/...

Gecombineerde twee en drie arms zelfspannende trekkers

- Voor 2- of 3-arm gebruik
- Zelfspannend mechanisme



	L mm	L1 mm	€		
1517C/0	145	250	257,00	1	015170500
1517C/1	200	300	316,00	1	015170501
1517C/2	270	300	391,00	1	015170502

	A mm	● mm
1517C/0	12÷140	18
1517C/1	20÷180	18
1517C/2	30÷280	18

1518/...

Drie-armige trekkers



	L mm	€		
1518/1	105	107,00	1	015180001
1518/2	135	137,50	1	015180002
1518/3	235	237,00	1	015180003
1518/4	270	341,00	1	015180004
1518/5	270	390,00	1	015180005
1518/6	270	416,00	1	015180006

	A min+Max mm	L1 mm
1518/1	24÷100	105
1518/2	32÷160	150
1518/3	40÷220	220
1518/4	80÷250	240
1518/5	80÷300	350
1518/6	80÷350	400

1518U/...

Drie armige universele trekkers

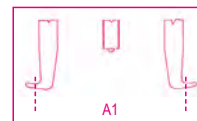
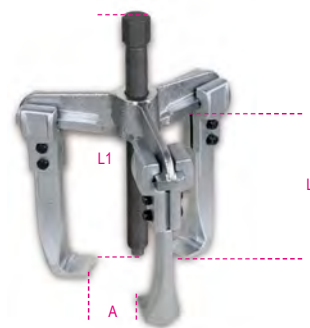

	L mm	L1 mm	€		
1518U/0	100	166	176,50	1	015180500
1518U/1	100	166	190,50	1	015180501
1518U/2	150	247	289,00	1	015180502
1518U/3	150	247	301,00	1	015180503
1518U/4	200	321	435,00	1	015180504

	A min+Max mm	A1 min+Max mm	● mm
1518U/0	40÷90	80÷130	17
1518U/1	50÷130	90÷170	17
1518U/2	65÷150	115÷210	22
1518U/3	65÷190	125÷260	22
1518U/4	70÷235	170÷335	27

1519/...

Drie armige universele trekkers met snelspan instelling en sluiting

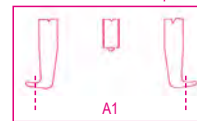
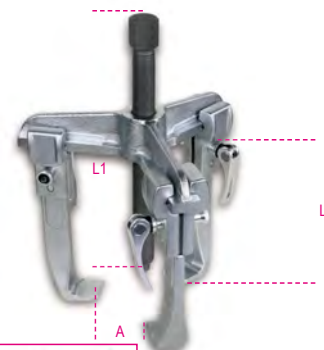

	L mm	L1 mm	€		
1519/0	100	166	203,50	1	015190000
1519/1	100	166	217,00	1	015190001
1519/2	150	247	310,00	1	015190002
1519/3	150	247	329,00	1	015190003

	A min+Max mm	A1 min+Max mm	● mm
1519/0	40÷90	80÷130	17
1519/1	50÷130	90÷170	17
1519/2	65÷150	115÷210	22
1519/3	65÷190	125÷260	22



1520/1 - 1520/2

Twee-armige trekkers met omkeerbare armen



	L mm	€		
1520/1	135	101,50	1	015200101
1520/2	235	173,00	1	015200102

	A Max mm	L1 mm
1520/1	110	85
1520/2	160	140

1521/1 - 1521/2

Drie-armige trekkers



	L mm	€		
1521/1	135	135,50	1	015210101
1521/2	235	228,00	1	015210102

	A Max mm	L1 mm
1521/1	110	90
1521/2	160	140

1528

Zelfborgende trekker voor remschijven



∅ 19 mm

	A min+Max mm	€		
1528	170÷380	207,50	1	015280000

260x240x60 mm - 4,8 kg

1529

Verstelbare trekker voor gegroefde poelie

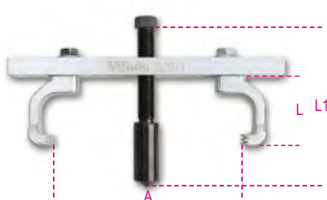

	A min+Max mm	L min+Max mm	L1 min+Max mm	€		
1529	24÷240	60÷95	90÷135	305,00	1	015290000

260x210x60 mm - 2,6 kg

1529/C7

Trekker voor poelies

Set omvat:

- 2 armen met twee klauwen 4.7-mm-dik
- 2 armen met een klauw 4.3-mm-dik
- 1 arm met twee klauwen 2.3-mm-dik
- 1 arm met een klauw 2.3-mm-dik

De samenstelling van de armen kunnen aangepast worden aan de benodigheden

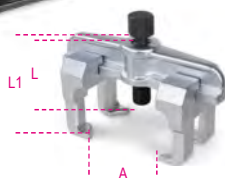

	L mm	L1 mm	A min+Max mm	€		
1529/C7	50	72,5	53÷114	154,50	1	015290100

285x155x50 mm - 2 kg

1529PI

Universele trekker voor de pully van de injectiepomp

- Maakt het mogelijk de pully van de injectiepomp snel en nauwkeurig te verwijderen.
- Uitermate geschikt voor Fiat, Ford, Volkswagen, Citroën en Peugeot voertuigen.

Inclusief 3 paar bouten voor het bevestigen van de trekker aan de pully:

- M6 x 1.0 x 49 mm
- M7 x 1.0 x 75 mm
- M8 x 1.25 x 76 mm



	€		
1529PI	123,00	1	015290051

1529/PG

Speciale dopsleutel voor de hogedruk dieselpomp, voor VAG groep voertuigen



	∅ mm	€		
1529/PG	15-24	79,00	1	015290010

1530/C5

Naaf en kogellagertrekker kit, 3, 4, 5 gaten

Kit bevat:

- 1 universele flens (96÷138 mm)
- 1 hydraulische trekker (12 t)
- 1 slaggewicht (2.8 kg), nodig voor nafen zonder centrale borgmoeren



	€		
1530/C5	599,00	1	015300300

760x320x120 mm - 11,5 kg

1530/C16

Slaghamer kit met afstandhouders, voor het trekken van wielnafen en lagers met 3, 4, 5 gaten

Ideaal voor nafen met uitspringende centreer ringen

Kit omvat:

- 1 universele flens (90÷130 mm)
-)
- 1 slaghamer (5 kg)
-)
- 4 M12 koppelbare afstandhouders
- 4 M14 koppelbare afstandhouders



	€		
1530/C16	750,00	1	015300316

760x310x100 mm - 13,5 kg

1531/C7

Demontage set voor binnenringen wiellager

Bevat de maten:

- 1 trekker Ø 40÷45 mm
- 1 trekker Ø 45÷51 mm
- 1 trekker Ø 50÷55 mm
- 1 trekker Ø 55÷61 mm



1531/C7 € 850,00 1 015310107

390x315x96 mm - 4,3 kg

1532

Pakking en oliekeerring verwijderaar



1532 € 17,40 2 015320001

1533/...

Trekstangen voor schoteltrakkers 1534



L mm	€		
1533/2 150	132,00	1	015330002
1533/3 210	245,50	1	015330003
1533/4 315	391,00	1	015330004
1533/5A 305	468,00	1	015330006

A min÷Max mm	L1 mm
1533/2 45÷140	110
1533/3 55÷205	175
1533/4 90÷260	175
1533/5A 100÷360	235

1533PR/1-2-3

Verlengstukken voor trekkers 1533



	€		
1533PR/1 1533/2	30,00	1	015330011
1533PR/2 1533/3	32,50	1	015330012
1533PR/3 1533/4	36,50	1	015330013
1533PR/5A 1533/5A	36,50	1	015330016

1534/...

Schoteltrakkers

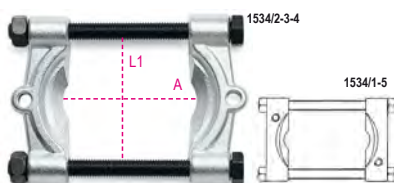

		€		
1534/1	1533/2	114,50	1	015340001
1534/2	1533/2	135,00	1	015340002
1534/3	1533/3	221,00	1	015340003
1534/4	1533/4	371,00	1	015340004
1534/5A	1533/5A	763,00	1	015340006

	A min÷Max mm	L1 mm
1534/1	5÷60	63
1534/2	12÷75	75
1534/3	22÷115	118
1534/4	25÷155	154
1534/5A	30÷220	180

1535/C...

Trekkerket



1535/C1 € 364,00 1 015350001

1533/2
1533PR/1
1534/1

260x180x40 mm - 2,5 kg

1535/C2 € 385,00 1 015350002

1533/2
1533PR/1
1534/2

260x180x40 mm - 2,8 kg

1535/C3 € 619,00 1 015350003

1533/3
1533PR/2
1534/3

380x280x55 mm - 8,0 kg

1535/C4 € 966,00 1 015350004

1533/4
1533PR/3
1534/4

420x380x65 mm - 14,8 kg

1535/C5A € 1.465,00 1 015350006

530x510x85 mm - 27,2 kg

1539

Slaggewicht voor plaatwerk



1539 € 199,50 1 015390001

1540

Slaggewicht

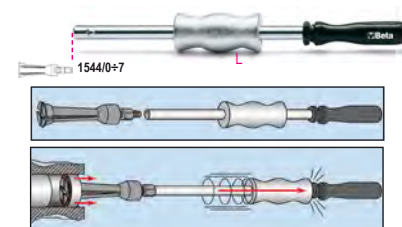

1540 € 112,00 1 015400001



1542/1 - 1542/2

Twee-armige trekkers



	A	min+Max	1544	€		
	mm	mm	mm			
1542/1	35÷75	0÷7		92,50	1	015420001
1542/2	60÷130	9C-10C		146,00	1	015420002

	L	L1
	mm	mm
1542/1	140	140
1542/2	175	160

1544/...

Binnentrekkers

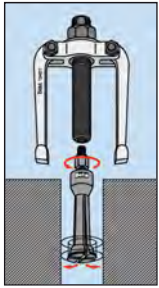

	C	Ø	€		
	mm	M			
1544/0	0,25	M10	81,50	1	015440100
A= 5÷7					
1544/A	0,80	M10	86,00	1	015440105
A= 7÷9					
1544/1	0,80	M10	90,00	1	015440110
A= 9÷12					
1544/2	1,15	M10	91,50	1	015440120
A= 13÷17					
1544/2B	1,00	M10	93,00	1	015440121
A= 14÷19					
1544/3	1,70	M10	95,50	1	015440130
A= 16÷21					
1544/4	1,65	M10	106,00	1	015440140
A= 20÷25					
1544/5	2,00	M10	117,00	1	015440150
A= 25÷30					
1544/6	3,00	M10	144,50	1	015440160
A= 30÷37					
1544/7	3,80	M10	162,50	1	015440170
A= 38÷45					
1544/9C	2,60	G 3/8"	235,00	1	015440189
A= 40÷75					
1544/10C	7,30	G 3/8"	338,00	1	015440199
A= 70÷115					

1545/C5M

Trekker 1542/1
met 5 binnentrekkers 1544



1545/C5M € 637,00 1 015450011

1542/1	● 24 mm
1544/1	9÷12 mm
1544/2	13÷17 mm
1544/3	16÷21 mm
1544/4	20÷25 mm
1544/5	25÷30 mm

265x180x45 mm - 2,4 kg

1547/C6

Kogellagertrekker (dummy kogels)



1547/C6 € 321,00 1 015470006

420x185x60 mm - 3 kg

1547/KP

Set van 3 paar dummy kogel klemmen



	Ø	€		
	mm			
1547KP/1	9-11-12,5	55,00	1	015470106
1547KP/2	5-6-8	37,50	1	015470206

1547P

Verlengstukken zeskant



	L	mm	€		
1547P/1	205	1547/1	12,00	1	015470101
1547P/2	102	1547/2	7,30	1	015470201

1547PC/2

Ronde verlengstukken, korte uitvoering



	L	mm	€		
1547PC/2	42	1547/2	6,00	1	015470202

1547PL/2

Ronde verlengstukken, lange uitvoering



	L	mm	€		
1547PL/2	106	1547/2	6,65	1	015470203

1549

Kit voor het verwijderen en monteren van
dubbelwerkende schokdempers op gas

Maakt het mogelijk de spindel recht te houden terwijl de veren
gemonteerd worden



1549 € 502,00 1 015490001

310x270x110 mm - 3 kg



1550U

Pneumatische veerspanner voor personenwagens, SUVs en bedrijfsvoertuigen

CE

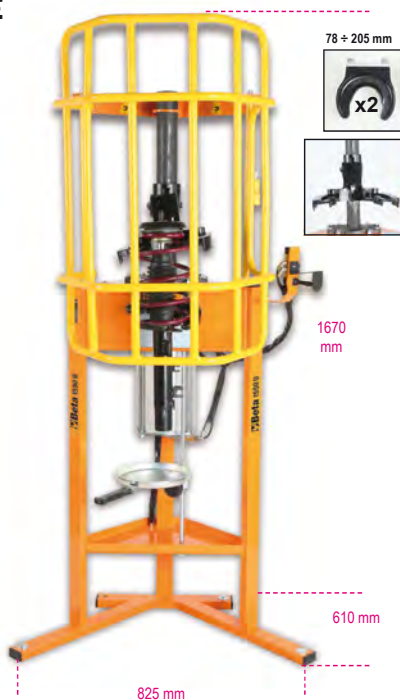

VERHOOGDE COMPRESSIE: maximale druk 2 ton (10 bars)
UNIVERSEEL BORGSYSTEEM BOVENZIJD: maakt het mogelijk linkse en rechtse veren van verschillende diameters samen te drukken met de bovenste instelbare veerhouder.
ACTIEF VEILIGHEIDSSYSTEEM RONDOM DE VEER: veiligheidshaak en 3 sluitkleppen maken het mogelijk de veer correct te positioneren en te ondersteunen gedurende het samendrukken.

Indien de veer niet correct is gepositioneerd zal het systeem het apparaat doen stoppen.

BESCHERMENDE "FULL BODY" ROOSTER: geeft maximale bescherming en beslaat het hele werkgebied.

GECONTROLEERDE WERKING VAN DE SPANNER:

toeneemende nauwkeurigheid en gevoel tijdens het samendrukken.

WERKBEREIK: werkhogte op de achterste veerhouder heeft een bereik tot 875 mm.

Geleverd met 2 onderste veerhouders voor veren met een diameter van 78-205 mm.

TECHNISCHE GEGEVENS

Maximale druk: 2 ton (10 bars) - 1.6 ton (8 bars) - 1.2 ton (6 bars)
 Compressieslag: 335 mm.

1550U € 3.310,00 1 015500010

1550U/CGS-R

Lage bovenste veerhouders, paar, voor artikel 1550U



1550U/CGS-R € 662,00 1 015500035

1550U/MRC-ABE

Speciale veerhouders voor artikel 1550U, Specifiek ontworpen voor Mercedes A-B-E klasse voertuigen



1550U/MRC-ABE € 688,00 1 015500031

1550U/MRC-C

Speciale veerhouders voor artikel 1550U, Specifiek ontworpen voor Mercedes C klasse voertuigen



1550U/MRC-C € 613,00 1 015500032

1550U/S...

Onderste veerhouder voor artikel 1550U



	Ø mm	€		
1550U/S 130	78÷130 mm	413,00	1	015500014
1550U/S 182	105÷182 mm	445,00	1	015500015
1550U/S 205	125÷205 mm	409,00	1	015500016

1550U/SS187

Linkse veerhouder voor artikel 1550U

Uitermate geschikt voor linkse veren, bijv.: Nissan Qashqai en Renault Koleos



1550U/SS 187 € 441,00 1 015500018

1550U/M

Klem voor schokdemper bij veerspanner artikel 1550U

Maakt het mogelijk de schokdemper vast te zetten.



1550U/M € 406,00 1 015500021

1551/C20

Set gereedschappen voor het verwijderen schokdemper koppen

Set bevat:

- 7 Zeskant dopsleutels, maten: 16 - 17 - 18 - 19 - 21 - 22 - 24
- 1 Dopsleutel verlengstuk, lengte: 120 mm
- 3 Sleuf inwendig bits, maten: 8x5 - 8x6 - 11x8
- 1 Zeskant inwendig bit, maat: 10 mm
- 1 Uitwendig XZN(R) bit, maat: M10
- 1 Uitwendig Torx(R) bit, maat: T50
- 4 Zeskant bits, maten: 5 - 6 - 7 - 8
- 1 Verlengde bithouder, lengte: 95 mm
- 1 Verlengde bithouder, lengte: 190 mm



1551/C20 € 177,00 1 015510020

320x245x71 mm - 2,6 kg

1552/C9

Set voor het uiteen drukken van schokdemperbevestiging, fusee en draagarm verbinden.

Het gebruik maken van enkele of dubbele trekker maakt het ook mogelijk om aan dubbele draagarmen te werken, b.v. Voertuigen van VAG groep



1552/C9 € 140,50 1 015520020

195x140x40 mm - 1,0 kg



1555/Q

Veerspanner voor MacPherson en gelijkwaardige schokdemperversen

Maximale duwkracht: 1500 kg

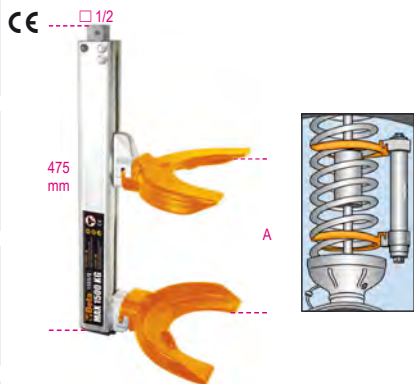

A	Ø	€		
min+Max mm	min+Max mm			
65+354	80=195	917,00	1	015550006

1555/QS

Veerspanner voor MacPherson en gelijkwaardige schokdempers

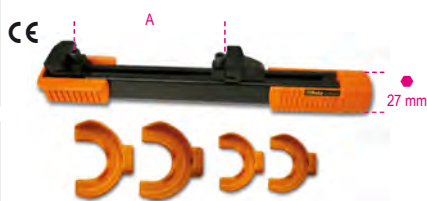

A	Ø	€		
min+Max mm	min+Max mm			
70+300	80=200	1.120,00	1	015550005

1555S/BMW-RNT

Veerhouder voor BMW E39, E46 en Renault Mégane II schokdempers, passend op 1555Q en 1555/QS



1555S/BMW-RNT	€			
	362,00	1	015550303	

1555C

Telescopische veerspanner met vier veerhouders en een momentbegrenzer



A	Ø	N	t	€		
min+Max mm	min+Max mm					
80=225	90=160	25000	8,5	1.150,00	1	015550202

1556/1A

Veerspanner

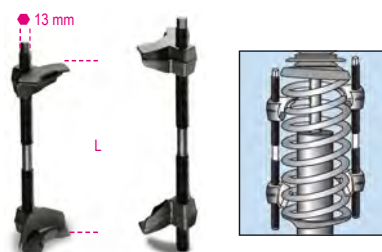

min L Max mm	€			
65=320	266,00	1	015560101	

1556/2A

Veerspanner

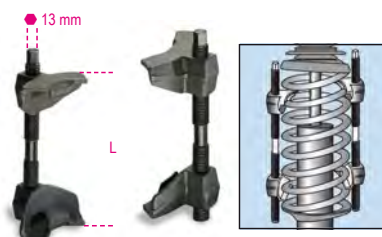

min L Max mm	€			
65=200	264,00	1	015560102	

1557

Slagdopsleutels voor bladveerpennen



L	L1	€		
mm	mm			
37	28	95,50	1	015570137
46	34	99,00	1	015570146
56	34	105,50	1	015570156

1557V

Slagdoppen voor Volvo vrachtwagen bladveren



mm	€			
27	51,50	1	015570299	

1557/S3

3-delig set speciale doppen voor schokdempermoeren

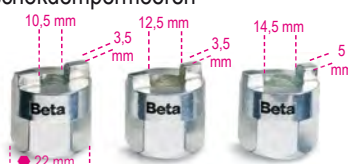

1557/S3	€			
	75,00	1	015570010	

1558/C4

Borgveertang, voor interne en externe ringen, bediening door schroefdraad

Het vierkante aandrijf gedeelte maakt het mogelijk om grote kracht te ontwikkelen in zowel het monteren als in het demonteren
Meegeleverde punten:
Ø 2.5-3-3.5 mm



1558/C4	Ø mm	Ø mm	€		
	5,5 ÷ 7,7	5,5 ÷ 7,7	185,00	1	015580100
	330x220x50 mm				900 g

1558P

Reserve bekken, paar, voor artikel 1558



Ø mm	€		
2,5	7,45	1	015580125
3,0	7,45	1	015580130
3,5	7,45	1	015580135

1558/C13

Tang voor interne en externe seegerringen, bediening door schroefdraad

Het aandrijfvierkant maakt het mogelijk om grote kracht over te brengen in beide richtingen

Meegeleverde punten:
• Recht: Ø 2.5 - 3 - 3.5 - 3.8 mm
• 45°: Ø 2.5 - 3 - 3.5 - 3.8 mm
• 90°: Ø 2.5 - 3 - 3.5 - 3.8 mm



1558/C13	Ø mm	Ø mm	€		
	5,5 ÷ 7,7	5,5 ÷ 7,7	249,50	1	015580200
	330x220x45 mm				1,6 kg

1559

Stuurkogeltrekker, lichte uitvoering



	A Max mm	Ø mm	€		
1559/22	50	18÷22	101,00	1	015590001
1559/36	90	36	446,00	1	015590036
1559/45	115	45	679,00	1	015590045

1559V/8T

Hydraulische schroefspindel voor stuurkogeltrekkers 1559/36 en 1559/45. Voor zware voertuigen

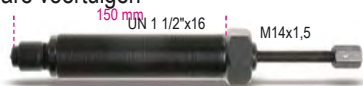

Nm	t	€		
80000	8	342,00	1	015590145

1560/2

Stuurkogeltrekker, zware uitvoering



	A min+Max mm	Ø mm	€		
1560/2	60÷85	20	220,50	1	015600002

1560A

Stuurkogeltrekker



	€		
1560A	301,00	1	015600601

1561/...

Uitdrukker voor spoorstangkogels



	L mm	A mm	Ø mm	€		
1561/1	39	36,6	18	79,50	1	015610001
1561/2	47	45,7	25	105,50	1	015610002
1561/3	63	62	30	148,00	1	015610003
1561/4	75	63	40	197,00	1	015610004

1562D

Stuurkogeltrekker

Geleverd met twee bouten voor het trekken van zowel stuur als fusee kogels



A max mm	Ø mm	• mm	L mm	€		
50	39	26	155	382,00	1	015620239

1563/C4

4-delig set doppen voor het verwijderen van kogelgewricht

Voor gebruik met persluchthamer

Set bevat:

- 1 dop M12x1.25 mm
- 1 dop M12x1.5 mm
- 1 dop M14x1.5 mm
- 1 dop M16x1.5 mm



22/24 mm

	€		
1563/C4	56,00	1	015630010

1565/1-2-3

Demontage vorken



	Ø mm	L1 mm	€		
1565/1	18	65	91,00	1	015650001
1565/2	23	65	104,00	1	015650002
1565/3	30	88	111,00	1	015650003

1566N

Apparaat voor het verwijderen en monteren van spoorstangen



Ø x L mm	○ mm	□ mm	€		
28÷35 x 400	27	12"	144,00	1	015660005
35÷45 x 190	27	-	144,00	1	015660008
35÷45 x 400	27	12"	156,50	1	015660010

1566R

Verstelbare tool voor het verwijderen / installeren van stuurarmen



Ø mm	€		
27÷43	26,50	1	015660015

1566/G01

Homokineet trekker

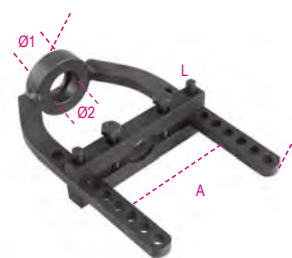

L mm	A mm	Ø1 mm	Ø2 mm	€		
250	115	29	36	162,50	1	015660052

1566P

Borgveertang voor de borging van de homokineet

De tang drukt de veer samen, waarna het eenvoudig is de as te bevestigen aan de homokineet



L mm	A Max mm	€		
280	36	78,50	1	015660091

1567

Hefboom voor het verwijderen van draagarmen en schokdempers van de fusee
Slechts een monteur nodig voor het bedienen



A mm	B min+Max mm	€		
1060	100÷300	389,00	1	015670001

1568

Pneumatisch monteergereedschap voor silicone ashoezen

8 spreider armen

Maximale spreiding: 145 mm

CE



L mm	L1 mm	€	🔧	🚚
420	195	274,00	1	015680001

1569/F

Gereedschaps assortiment voor het verwijderen en vervangen van draagarm rubber bij Fiat Panda, Fiat 500 en Ford Ka



1569/F	€	🔧	🚚
	509,00	1	015690021

1569/SB

assortiment gereedschappen voor het de-monteren van silentblokken op de achteras, aandrijf-as oliekeerringen en wielagers

• De bussen kunnen zowel op voertuig als op hydraulische pers worden gebruikt



1569/SB	€	🔧	🚚
	282,00	1	015690016

425x365x100 mm - 13 kg

1569CP

Slagbus voor het plaatsen van conische lagers en oliekeerringen

Snel instelbaar



	∅ min=Max mm	L mm	€	🔧	🚚
1569CP/50	9,5÷50	130	142,00	1	015690750
1569CP/90	18÷90	145	169,00	1	015690790

1570/3

Hydraulische vijzel



t	L mm	L1 mm	∅ mm	€	🔧	🚚
30	243	36	19	281,00	1	015700003

1580/8I

Twee-armige hydraulische trekker

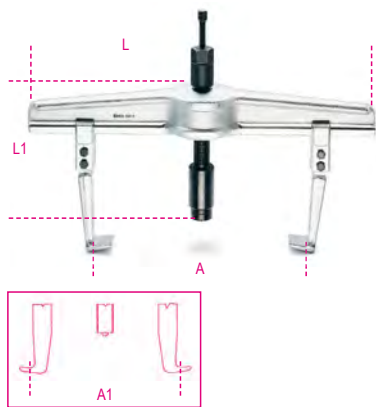

1580/8I	€	🔧	🚚
	1.880,00	1	015800008

	A min=Max mm	L mm	L1 mm	A1 min=Max mm	N Max
1580/8I	170÷640	715	280	260÷715	180000

1580GL

Losse armen, lange uitvoering voor trekker 1580/8I



	L mm	€	🔧	🚚
1580GL/8A	300	208,00	1	015800227
1580GL/8B	400	227,50	1	015800228
1580GL/8C	500	294,00	1	015800229

1585/5I - 6I - 7I

Drie-armige hydraulische trekkers

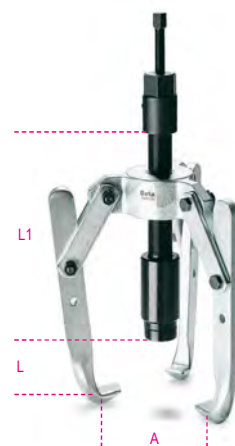

	€	🔧	🚚
1585/5I	1.315,00	1	015850005
1585/6I	1.385,00	1	015850006
1585/7I	1.425,00	1	015850007

	A min=Max mm	L1 mm	L mm	N Max
1585/5I	50÷350	135	280	150000
1585/6I	50÷350	235	280	150000
1585/7I	50÷350	335	280	150000

1585GI/5 - 6 - 7

Armen voor hydraulische trekkers

1585/5I-1585/6I-1585/7I

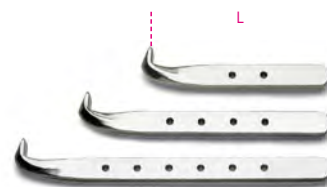

	L mm	€	🔧	🚚
1585GI/5	135	123,50	1	015850205
1585GI/6	235	143,50	1	015850206
1585GI/7	335	175,50	1	015850207

1589VI

Hydraulische schroefspindel 1580/8I en 1585/5I-1585/6I-1585/7I



1589VI	€	🔧	🚚
	770,00	1	015890001

1589PI/50 - 100 - 150

Verlengstukken voor hydraulische schroefspindel



	L mm	L1 mm	€	🔧	🚚
1589PI/50	50	70	70,50	1	015890005
1589PI/100	100	120	78,50	1	015890010
1589PI/150	150	170	86,50	1	015890015

1590

C-klemmen



A max mm	L1 mm	€		
60	55	32,50	2	015900305
100	65	51,50	2	015900310
150	95	86,50	2	015900315

1591

Lijmtangen

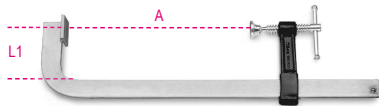

A	A max mm	L1 mm	€		
200	200	80	32,50	2	015910020
300	310	85	40,00	2	015910030
400	410	85	43,50	2	015910040
500	500	95	58,00	2	015910050
600	600	95	59,00	2	015910060
800	800	95	71,00	2	015910080
1000	1000	110	88,50	2	015910100

1593

Lijmtangen

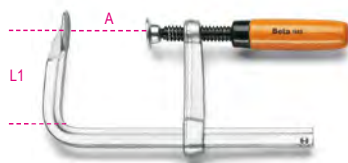

A	A max mm	L1 mm	€		
160	170	80	45,00	2	015930016
200	240	100	66,50	2	015930020
300	320	145	92,50	2	015930030

1594

Lijmtangen met snelsluiting

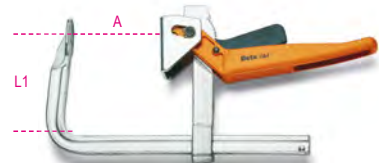

A	A max mm	L1 mm	€		
200	240	145	144,00	1	015940020
250	290	145	150,00	1	015940025
300	340	145	159,50	1	015940030
400	430	150	167,00	1	015940040
500	530	150	177,00	1	015940050
600	630	150	186,00	1	015940060

1595

Lijmtangen

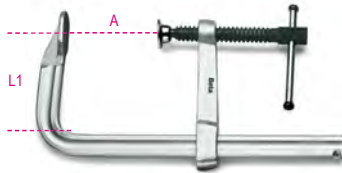

A	A max mm	L1 mm	€		
200	230	100	68,50	2	015950020
250	270	120	76,00	2	015950025
300	330	120	96,50	2	015950030
400	420	120	106,00	2	015950040
500	520	125	115,00	2	015950050
600	620	125	121,50	2	015950060
800	820	125	146,00	1	015950080
1000	1030	125	160,00	1	015950100

1599F

parallele bankschroeven, gesmeed

Volledig gegoten staal. Gefreesd en gehard oppervlak.
Opening aan de voorkant. Hoge klemdiepte.



L1 mm	BxH mm	Ø mm	A MAX mm	€		
100	92x46	11	125	372,00	1	015990100
125	108x54	13	150	480,00	1	015990125
150	125x62	13	200	666,00	1	015990150
175	140x70	15	220	907,00	1	015990175

1599GI

Parallel bankschroef met verwisselbare
bekken

- Heavy-duty bankschroef met vierkante geleider
- Verwisselbare, op het oppervlak geharde bekken

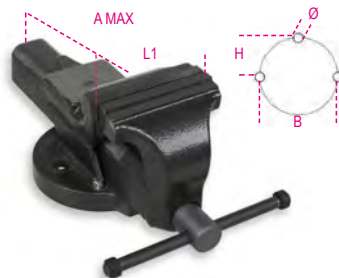

L1 mm	BxH mm	Ø mm	A MAX mm	€		
100	92x46	11	125	287,00	1	015990200
125	108x54	13	150	395,00	1	015990225
150	125x62	13	200	539,00	1	015990250
175	140x70	15	220	719,00	1	015990275

1599GR

paar reservebekken en schroeven voor
bankschroef 1599GI



	A mm	€		
1599GR 100	100	27,00	1	015990920
1599GR 125	125	34,50	1	015990925
1599GR 150	150	42,00	1	015990950
1599GR 175	175	48,50	1	015990975

1599P

bankschroeven parallel

Geharde bekken
Aambeeld met groot gelakt oppervlak.
Vierkante stalen voet

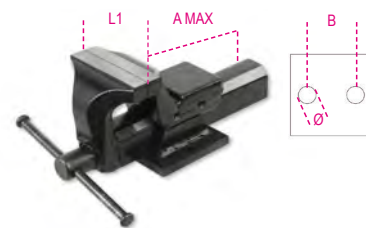

L1 mm	B mm	Ø mm	A MAX mm	€		
100	92	11	111	325,00	1	015990000
125	108	13	130	390,00	1	015990025
150	130	15	170	545,00	1	015990050

1599B

Draaiplateau voor bankschroeven 1599P



	1599P	€		
1599B 100	100	138,00	1	015990810
1599B 125	125	155,50	1	015990812
1599B 150	150	194,00	1	015990815

1599T

boormachineklem

Speciale gietijzeren bankschroeven, met geharde en geslepen
bekken.
Voor gebruik op kleine en middelgrote kolomboormachines

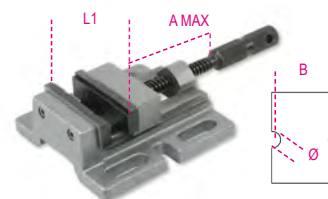

L1 mm	B mm	Ø mm	A MAX mm	€		
80	111	11	65	185,00	1	015990480
100	120	13	87	227,50	1	015990500

1599G

Paar aluminium bekbeschermers

- magnetisch over totale lengte
- inwendig gefreesd om schroefdraaddelen te borgen

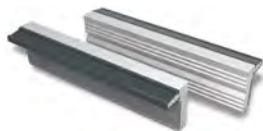

A mm	€	1	015990910
100	59,50	1	015990910
125	62,50	1	015990912
150	68,00	1	015990915
180	75,50	1	015990917

1600Q 8

Universele 4 weg schakelkastleutel

Vierkant 5/6/7-8 mm
Driehoek 7 / 9 mm
Dubbelbaard 3-5 mm
Zeskant 1/4"
Sleufkop 1,0x7 mm + kruiskop PH2



L mm	€	1	016000008
76	33,00	1	016000008

1600Q 10

Universele 8 weg schakelkastleutel met kniegewricht

Vierkant 5 / 6-7 / 8-9 mm
Driehoek 5-6-7 / 8-9 / 10 mm
Dubbelbaard 3-5 mm
Zeskant 1/4"
Aandrijfvierkant 1/4"



L mm	€	1	016000010
125	42,50	1	016000010

CERTIFICATIESERVICE VOOR MEETINSTRUMENTEN

Certificering van meetinstrumenten is essentieel in de sectoren of toepassingsgebieden waar nauwkeurige, eenduidige, herkenbare metingen vereist zijn. Certificering omvat de afgifte van een Accredia-certificaat:

Op verzoek biedt Beta Utensili S.p.A. de certificeringsservice voor schuifmaten, digitale schuifmaten, meetklokken, micrometer en voelermaten. Neem voor deze service contact op met uw dealer.



1650

Schuifmaat, universeel, uitlezing tot 0.05 mm

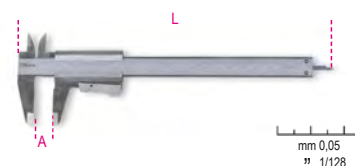

UNI EN ISO 13385-1DIN 862

A max mm	L mm	€	1	016500001
150	235	73,00	1	016500001
200	290	96,50	1	016500002

1650FD

Schuifmaat voor remschijven, uitlezing tot 0.1 mm

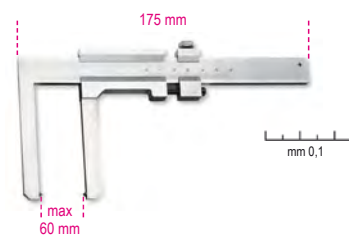

1650FD	€	1	016500050
	272,00	1	016500050

1650FT

Schuifmaat voor remtrommels, uitlezing tot 0.05 mm

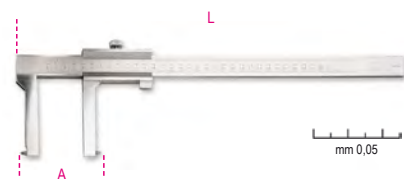

	A max mm	L mm	€	1	016500060
1650FT/1	350	438	466,00	1	016500060
1650FT/2	500	550	803,00	1	016500070

1651DGTB

Digitale schuifmaat, uitlezing tot 0,01mm

- Functies:
- Uitlezing tot 0,01 mm
 - Borgschroef
 - MM / INCH-conversie
 - Nul-instelling op elke positie
 - Vierkant dieptestang tot 300 mm
 - In hard kunststof koffer

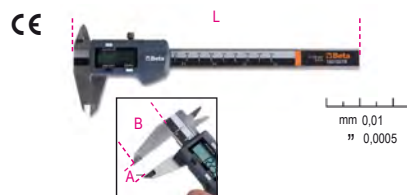

UNI EN ISO 13385-1DIN 862CE

A Max mm	L mm	B mm	€	1	016510211
150	235	40	125,00	1	016510211
200	285	50	163,00	1	016510212
300	400	60	212,50	1	016510213

1651DGTB/IP

Digitale schuifmaat, uitlezing tot 0,01 mm .
Bescherming IP67

- Uitlezing tot 0,01 mm
- Borgschroef
- mm/inch conversie
- automatisch inschakelen door de nonius langs de pool te bewegen
- nulinstelling op elke positie
- HOLD-functie
- absolute en incrementele meetmodi

Beschermingsgraad IP67 biedt totale bescherming tegen stof en vloeistoffen, waarbij de functionele kenmerken behouden blijven, b.v. wanneer het volledig is ondergedompeld.

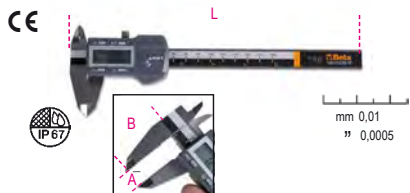

UNI EN ISO 13385-1 DIN 862CE

A Max mm	L mm	B mm	€		
150	235	40	204,50	1	016510711

270x115x35 mm - 450 g

1652

Schuifmaat met meetklok analoge uitlezing tot 0.02 mm



UNI EN ISO 13385-1DIN 862

1652	€		
	171,00	1	016520016

1654

Werkplaats schuifmaat uitlezing tot 0.02 mm



UNI EN ISO 13385-1DIN 862

A max mm	L mm	€		
200	330	378,00	1	016540020
300	410	508,00	1	016540030

Beta

1654DGT

Digitale schuifmaat
Uitlezing tot 0.01 mm
Uitlezing tot 0.0005"

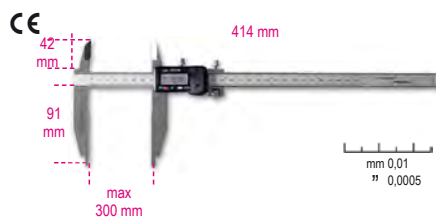

UNI EN ISO 13385-1DIN 862CE

1654DGT	€		
	800,00	1	016540111

1656

Diepteschuifmaat
uitlezing tot 0.02 mm



UNI EN ISO 13385-2DIN 862

A max mm	L mm	€		
200	260	174,50	1	016560020
300	360	256,00	1	016560030

1657DGT/2

Digitale diepteschuifmaat
uitlezing tot 0.01 mm

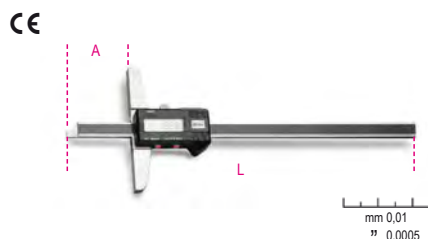

UNI EN ISO 13385-2DIN 862CE

1657DGT/2	A max mm	L mm	€		
	200	270	330,00	1	016570002

1658/...

Buiten micrometers
uitlezing tot 0.01 mm



DIN 863/II

	A mm	€		
1658/25	0÷25	99,00	1	016580025
1658/50	25÷50	112,00	1	016580050
1658/75	50÷75	127,00	1	016580075
1658/100	75÷100	135,50	1	016580100

1658/C4

4-delig set van buiten micrometers 1658



DIN 863

1658/C4	€		
	415,00	1	016580001

1658/25 0÷25 mm

1658/50 25÷50 mm

1658/75 50÷75 mm

1658/100 75÷100 mm

365x245x35 mm - 2,5 kg

1658DGTB

Digitale buitenmicrometers IP65, uitlezing tot 0,001 mm

- uitlezing tot 0,001 mm
- gehard staal
- Borgschroef
- MM / INCH-conversie
- nulinstelling op elke positie
- Absolute en incrementele meetmodi
- Geleverd met een kalibratiesleutel



DIN 863CE

1658DGTB 25	€		
	256,00	1	016580525
1658DGTB 50	318,00	1	016580550

Beta

Beta

1658SP/1

Standaard voor micrometers



1658SP/1 € 65,50 1 016580910

1659

Dikte meter met meetklok
uitlezing tot 0.01 mm

C = meetbereik



1659 C mm 0=10 € 262,00 1 016590001

1662/1 - 1662/2

Analoge meetklok
uitlezing tot 0.01 mm

C = meetbereik



DIN 878

1662/1	C mm 0=5	€ 120,00	1	016620001
1662/2	C mm 0=10	€ 144,50	1	016620010

1662DGT/A

Digitale meetklok,
Uitlezing tot 0.01 mm

C = meetbereik

CE



1662DGT/A C mm 0-12,5 € 326,00 1 016620311

1662AN

Instelbare meetklok met taster
Uitlezing tot 0.01 mm

C=meetbereik



DIN 2270

1662AN	C mm 0=0,8	€ 258,00	1	016620200
--------	------------	----------	---	-----------

1662SPO

Magnetische standaard



1662SPO € 89,00 1 016620800

1662SP2

Magnetische standaard, draaibaar



1662SP2 € 169,00 1 016620910

1666

Precisie winkelhaak vervaardigd
uit roestvast staal geslepen en gelapt



DIN 875/0

L mm	L1 mm	€	1	016660210
100	70	75,50	1	016660210
150	100	109,00	1	016660215
200	130	132,50	1	016660220
250	165	170,00	1	016660225
300	200	217,00	1	016660230

1666A

Precisie winkelhaak met aanslag
vervaardigd uit roestvast staal
geslepen en gelapt



DIN 875/0

L mm	L1 mm	€	1	016660110
100	70	128,50	1	016660110
150	100	175,50	1	016660115
200	130	246,50	1	016660120
250	170	308,00	1	016660125
300	200	391,00	1	016660130

1668

Winkelhaak vervaardigd uit genormaliseerd,
geslepen staal



DIN 875/2

L mm	L1 mm	€	2	016680210
100	70	34,50	2	016680210
150	100	45,50	2	016680215
200	130	58,50	2	016680220
250	165	85,50	1	016680225
300	174	103,00	1	016680230

Beta

1668A

Standaard winkelhaak met aanslag vervaardigd uit genormaliseerd geslepen staal



DIN 875/2

L mm	L1 mm	€		
100	70	44,00	2	016680110
150	100	67,00	2	016680115
200	130	85,00	2	016680120
250	165	116,50	1	016680125
300	176	140,00	1	016680130

1670

Winkelhaken vervaardigd uit geslepen staal



L mm	L1 mm	€		
100	70	22,90	3	016700010
150	100	24,20	3	016700015
200	130	26,50	3	016700020
250	160	29,00	3	016700025
300	175	32,50	3	016700030
400	230	47,50	2	016700040
500	280	51,50	2	016700050
600	330	52,50	2	016700060
800	420	74,50	1	016700080
1000	500	88,00	1	016700099

1670A

Winkelhaken met aanslag vervaardigd uit geslepen staal



L mm	L1 mm	€		
100	70	29,00	3	016700110
150	100	32,50	3	016700115
200	130	35,50	3	016700120
250	165	41,50	3	016700125
300	175	49,50	3	016700130
400	230	64,50	2	016700140
500	280	86,00	2	016700150
600	330	97,50	2	016700160
800	420	118,00	1	016700180
1000	500	145,00	1	016700199

1672

Verstelbare zwihaak blad en aanslag vervaardigd uit staal

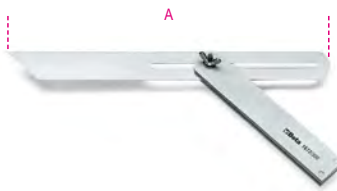

A mm	€		
300	67,00	2	016720030

1672A

Verstelbare schuif zwihaak. Blad is vervaardigd uit verchromd staal aluminium aanslag

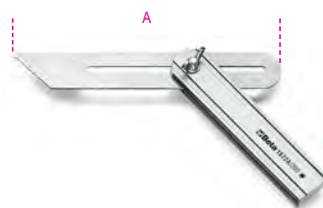

A mm	€		
200	37,00	3	016720120
300	40,00	3	016720130

1674A

Timmermans winkelhaak vervaardigd uit staal aluminium aanslag



L mm	L1 mm	€		
300	169	33,00	2	016740130
400	214	40,50	2	016740140

1674C

Timmermans winkelhaak met stalen oppervlak en bladen

- Dubbele mm-schaal
- Oppervlakteniveau

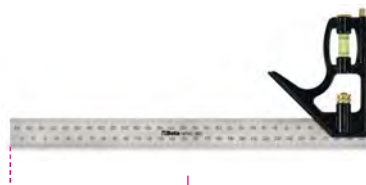

L mm	€		
300	25,00	2	016740230

1676

Hoekmeters vervaardigd uit roestvast staal

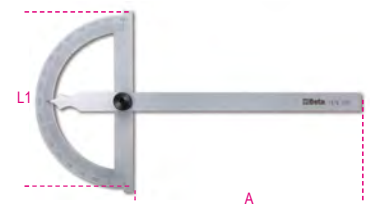

A	A mm	L1 mm	G mm	€		
120	120	80	1°	52,00	2	016760012
150	165	120	1°	59,50	2	016760015
200	210	150	1°	72,50	2	016760020
300	310	200	1°	96,50	1	016760030

1678/C3

Precisie hoekmeter vervaardigd uit roestvast staal



L Max mm	D mm	€		
300	70	370,00	1	016780030

1679

Universele passer met rol vervaardigd uit roestvast staal, uitzetting tot 0.1 mm

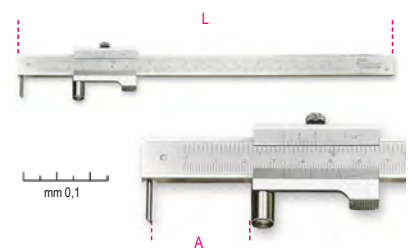

L mm	A Max mm	€		
235	200	108,50	1	016790020

1679/PR

Reserve punt voor universele passer 1679



L mm	€		
300	18,70	1	016790021

1680

Schuifpassers geharde stalen huis en punten

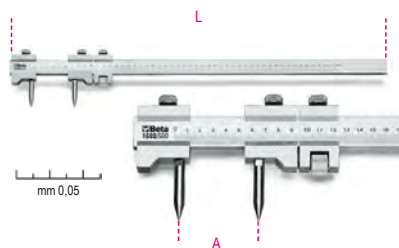

L mm	A Max mm	€	📦	🚚
660	500	388,00	1	016800050

1680A

Binnen meetpasser



L mm	A Max mm	€	📦	🚚
150	144	25,50	2	016800115
200	200	31,50	2	016800120
250	245	38,50	1	016800125
300	300	45,50	1	016800130

1680B

Dikte meetpasser



L mm	A Max mm	€	📦	🚚
150	155	25,50	2	016800215
200	190	31,50	2	016800220
250	235	38,50	1	016800225
300	280	45,50	1	016800230

1680C

Rechte steekpasser geharde rechte stalen punten



L mm	A Max mm	€	📦	🚚
150	138	25,50	2	016800315
200	190	31,50	2	016800320
250	235	38,50	1	016800325
300	280	45,50	1	016800330

1682

Flexibele linialen vervaardigd uit roestvast staal

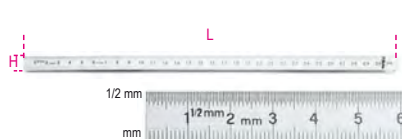

L mm	H mm	± mm	€	📦	🚚
150	13	0,5	3,80	5	016820015
200	13	0,5	4,40	5	016820020
250	13	0,5	5,15	5	016820025
300	13	0,5	6,55	5	016820030
500	13	0,5	14,30	2	016820050
1000	13	0,5	37,50	2	016820100

1683

Half stijve linialen vervaardigd uit roestvast staal

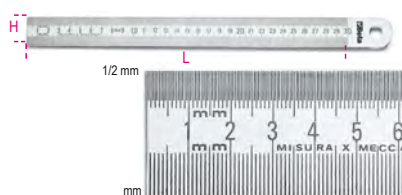

L mm	H mm	± mm	€	📦	🚚
300	30	1	12,20	5	016830030
500	30	1	19,80	2	016830050
1000	30	1	48,50	2	016830100
1500	30	1	111,50	1	016830150

1685/C7

7-delig set van meet en aftekengereedschap



1685/C7	€	📦	🚚
	382,00	1	016850110

	1650	160 mm
	1658/25	0+25 mm
	1670	100 mm
	1680C	150 mm
	1682	150 mm
	1688BC	165 mm
	1688BC/R	

320x210x37 mm - 1,2 kg

1687A

Monteurs precisiehaak, uiteinde 90° gebogen, met handgreep



1687A	L mm	L1 mm	€	📦	🚚
	153	80	7,95	1	016870120

1687AC

Monteurs precisiehaak, korte uiteinde 45° gebogen, met handgreep



1687AC	L mm	L1 mm	€	📦	🚚
	153	80	7,95	1	016870125

1687D

Monteurs precisiehaak, recht uiteinde, met handgreep



1687D	L mm	L1 mm	€	📦	🚚
	153	80	7,95	1	016870110

1687U

Monteurs precisiehaak, gebogen uiteinde, met handgreep



1687U	L mm	L1 mm	€	📦	🚚
	153	80	7,95	1	016870115

1687/S4

Set van 4 monteurs precisiehakken, met handgrepen



1687/S4	€	📦	🚚
1687A-1687AC 1687D-1687U	32,00	1	016870150

1688

Kraspen vervaardigd uit gehard staal



1688	L mm	Ø mm	€	5	016880020
	250	2	10,80		

1688A

Kraspen vervaardigd uit gehard staal, wolfram carbid punt



1688A	L mm	Ø mm	€	5	016880120
	200	4	18,90		

1688PC

Kraspen vervaardigd uit verchroomd en gehard staal



1688PC	L mm	Ø mm	€	1	016880300
	150	1	45,00		

1688PC/R

Reserve punt voor artikel 1688PC



1688PC/R	€	1	016880310
	13,00		

1688M

Timmermansplood



1688M	L mm	€	50	016880880
	180	1,00		

1690F

Fiberglas duimstok, nauwkeurigheidsklasse III

CE



1690F/2	L m	S mm	€	5	016900220
	2	17	15,40		

1690L

Houten duimstok, nauwkeurigheidsklasse III

CE

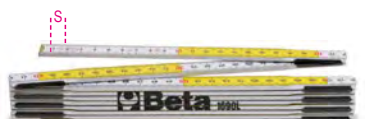

1690L/2	L m	S mm	€	5	016900200
	2	17	16,10		

1691BM

Rolbandmaten schokbestendige ABS behuizing, uit twee componenten, stalen meetlint, nauwkeurigheidsklasse: II

CE



1691BM/5	L m	S mm	€	1	016910205
	5	25	18,80		
1691BM/8	L m	S mm	€	1	016910208
	8	32	27,50		
1691BM/10	L m	S mm	€	1	016910210
	10	32	34,50		

1691MG

Rolbandmaat met magneten, Schokbestendige ABS-behuizing stalen meetlint, Nauwkeurigheidsklasse: II

CE



1691MG/5	L m	S mm	€	1	016910405
	5	25	17,10		
1691MG/8	L m	S mm	€	1	016910408
	8	25	24,40		
1691MG/10	L m	S mm	€	1	016910410
	10	25	26,00		

1692

Rolbandmaten, schokbestendig ABS huis uit bi-materiaal, stalen meetlint, precisie klasse II

CE



1692/2	L m	S mm	€	5	016920052
	2	16	9,20		
1692/3	L m	S mm	€	5	016920053
	3	16	11,70		
1692/5	L m	S mm	€	5	016920055
	5	19	16,60		
1692/8	L m	S mm	€	5	016920058
	8	25	24,10		

1693

Laser afstandsmeter, 20 meter

MEETINGEN:

- Enkel afstandsmeting
- Continue meeting of minimale meting

Automatische uitschakelfunctie

Levensduur batterij: tot 4,000 metingen

CE
IP54



TECHNISCHE GEGEVENS

Meetbereik: 0.05 + 20m (0.2ft + 66ft)

Maat eenheden: m, in, ft

Meetnauwkeurigheid: ±1.5 mm (± 0.06 in)

Laserklasse: 2

Batterijen: AAA 2 x 1.5V

1693 20	H mm	L mm	S mm	€	1	016930020
	100	36	23	146,50		

1693L

laser afstandsmeter, multifunctioneel, 40 m, met positioneringsniveaus

Metingen:

- Enkele afstandsmeting
- Continue meting of minimale meting

Functies:

- Optellen/afrekken
- Oppervlaktemeting
- Volumemeting
- Variabele indirecte meting (Pythagorese meting)
- Tilt meting

Automatische uitschakelfunctie

Levensduur van de batterij: maximaal 5.000 metingen

Zacht stoffen hoesje (inbegrepen)

CE
IP54



Technische data:

- Meetbereik: 0,05 + 40 m (0.2IN + 131F)
- Schaalselectie: M, in, ft
- Meetnauwkeurigheid: ± 1,5 mm (± 0,06 in)
- Laserklasse: 2
- Max. Opslag: 99 eenheden
- Batterijen: AAA 2 X 1.5V

1693L 40	H mm	L mm	S mm	€	1	016930040
	115	50	25	180,00		

1693M

laser afstandsmeter, multifunctioneel,
80 m

MEETINGEN:

- Enkele afstandsmeting
- Continue meting of minimale meting

FUNCTIES:

- Optellen / aftrekken
- Oppervlaktemeting
- Volumemeting
- Indirecte meting (Pythagoras meting)
- Tilt meting

Automatische uitschakelfunctie

Zacht stoffen hoesje (inbegrepen)

Levensduur batterij: tot 4.000 metingen



TECHNISCHE GEGEVENS

Meetbereik: 0,05 ÷ 80 m (0,2ft ÷ 229ft)

Maateenheden: m, in, ft

Meetnauwkeurigheid: ± 1,5 mm (± 0,06 inch)

Laserklasse: 2

Max. opslag: 99 eenheden

Batterijen: AAA 2 x 1,5 V.

	H mm	L mm	S mm	€	U	L
1693M 80	115	48	29	254,00	1	016930080

1694/L

Meetlint schokbestendig ABS huis,
PVC geplastificeerde glasvezel band,
nauwkeurigheidsklasse III

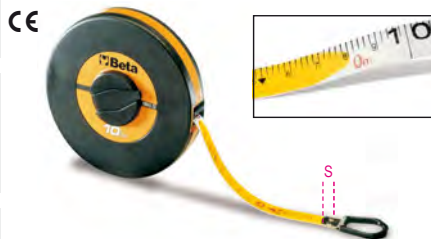

	L m	S mm	€	U	L
1694L10	10	13	16,50	1	016940110
1694L20	20	13	20,80	1	016940120

Beta

1694A/L

Rolbandmaat met handgreep,
schokbestendig ABS huis,
kunststof meetlint,
precisie klasse III

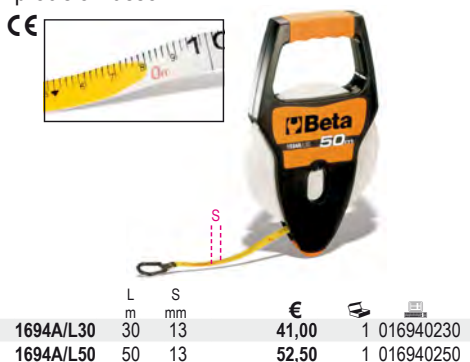

	L m	S mm	€	U	L
1694A/L30	30	13	41,00	1	016940230
1694A/L50	50	13	52,50	1	016940250

1694B/L

Meetlint met handgreep aluminium huis,
gelakte stalen band,
nauwkeurigheidsklasse II



	L m	S mm	€	U	L
1694B/L50	50	12,5	78,50	1	016940350

1695XS

Zak waterpas met magnetisch V vormige
behuizing vervaardigd uit geprofileerd
aluminium
2 onbreekbare libellen
Nauwkeurigheid: 1mm/m



	L mm	H mm	S mm	€	U	L
1695XS	70	48,5	20	16,50	5	016950250

1696

Waterpassen vervaardigd geanodiseerd,
geprofileerd aluminium,
onbreekbare libellen
nauwkeurigheid: 1 mm/m



	L mm	H mm	S mm	€	U	L
1696	200	50	19	27,50	2	016960002
	400	50	19	32,50	2	016960004
	500	50	19	35,50	2	016960005
	600	50	19	38,00	2	016960006
	800	50	19	48,00	2	016960008
	1000	50	19	53,50	2	016960010

1696A

Waterpassen vervaardigd uit gegoten
aluminium, met een geslepen meetvlak
en twee onbreekbare libellen,
nauwkeurigheid: 1 mm/m



	L mm	H mm	S mm	€	U	L
1696A	300	43	23	39,00	2	016960103
	400	43	23	41,00	2	016960104
	500	43	23	45,00	2	016960105
	600	43	23	50,50	2	016960106
	1000	43	23	100,00	1	016960110

1696B

Waterpassen vervaardigd
uit geanodiseerd geprofileerd aluminium
2 onbreekbare libellen,
nauwkeurigheid: 1 mm/m



	L mm	H mm	S mm	€	U	L
1696B	200	49	22	41,50	2	016960202
	300	49	22	45,00	2	016960203
	400	49	22	49,00	2	016960204
	500	49	22	57,50	2	016960205
	600	49	22	59,50	2	016960206

Beta

Beta

1696D

Waterpassen, vervaardigd uit gegoten aluminium. Vier meetvlakken en 3 onbreekbare libellen. Nauwkeurigheid: 1 mm/m



L mm	H mm	S mm	€		
300	47	25	35,50	2	016960353
400	47	25	39,50	2	016960354
500	47	25	44,50	2	016960355
600	47	25	50,00	2	016960356

1696S

Waterpassen vervaardigd uit aluminium, met 2 onbreekbare libellen nauwkeurigheid: 1mm/m



L mm	H mm	S mm	€		
1500	90	25	127,50	1	016960415
2000	90	25	149,50	1	016960420
2500	90	25	187,00	1	016960425
3000	90	25	212,50	1	016960430

1697

kruis laser niveau, 30 meter, groene straal, met magnetische voet en muurbeugel, in geval dat

TECHNISCHE SPECIFICATIES:

- zelfnivellerend kruis
- Zelfnivellerende functie kan worden uitgeschakeld voor handmatig gebruik
- laserdioden 515 Nm, klasse 2
- werkbereik: 30 m
- nauwkeurigheid: ± 1 mm bij 5 m
- zelfnivellerend bereik: $3^\circ \pm 0.5^\circ$

- body gemaakt van ABS en antislip rubber
- 1/4" aansluiting
- 2xAA-batterijen
- batterijduur: 4 uur

STATIEF:

- 1 magnetische voet voor individueel en gecombineerd gebruik, 1/4" aansluiting
- 1 verstelbare spanbeugel voor meerdere houten en metalen profielen (voor gebruik in combinatie met magneetvoet)
- snelle horizontale en verticale uitlijning in een hoek van 90°

CE



IP55



H mm	L mm	S mm	€		
82	57	89,5	321,00	1	016970030

320x230x90 mm

1699L

Aswaterpas vervaardigd uit gietijzer met een geslepen prismatische zool 2 onbreekbare libellen nauwkeurigheid tot 0.05 mm/m



DIN 877

	L mm	A mm	€		
1699L	200	49	386,00	1	016990002

1699L/1

Aswaterpas vervaardigd uit gietijzer met een geslepen prismatische zool 2 onbreekbare libellen nauwkeurigheid tot 0.02 mm/m



DIN 877

	L mm	A mm	€		
1699L/1	200	49	420,00	1	016990005

1699Q

Raamwaterpassen vervaardigd uit gietijzer met twee geslepen prismatische zolen en 2 geslepen platte zolen 2 onbreekbare libellen, nauwkeurigheid tot 0.05 mm/m



DIN 877

L mm	A mm	€		
150	40	539,00	1	016990015
200	48	669,00	1	016990020

1700N

Puntbeitels



L mm	S mm	€		
250	16	17,80	5	017000005
300	16	20,00	5	017000006

1700N/PM

Puntbeitels met handbeschermer



L mm	S mm	€		
250	16	25,50	2	017000105
300	16	29,00	2	017000106

1701N

Breekbeitels



L mm	A mm	S mm	€		
250	23	16	19,00	5	017010001
300	23	16	21,20	5	017010003

1701N/PM

Breekbeitels met handbeschermer



L mm	A mm	S mm	€		
250	23	16	24,70	2	017010101
300	23	16	28,50	2	017010103

1701PMR

Handbeschermers voor model 1700N en 1701N



D mm	L mm	€	U	U
16	115	12,00	1	017010206

1701NE/...

Elektricienbeitels



	SxL mm	€	U	U
1701NE3	10x200	11,10	5	017010406
1701NE4	10x250	12,00	5	017010409

1702N

Extra brede voegbeitels



A mm	SxH mm	€	U	U
50	13x23	24,70	2	017020005
70	13x23	26,00	2	017020007

1702N/PM

Extra brede voegbeitels met handbescherming



A mm	SxH mm	€	U	U
50	13x23	31,00	2	017020105
70	13x23	34,50	2	017020107



Het is aan te bevelen om de gereedschappen tijdens het naslijpen te koelen.

1702PMR

Handbescherming voor model 1702N



L mm	€	U	U
115	9,10	1	017020200

1704

Koevoet, vervaardigd uit gehard staal

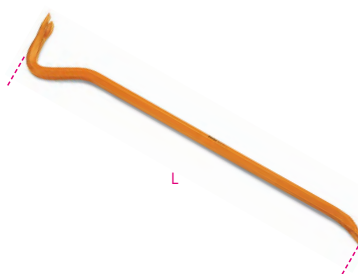

L mm	6 mm	mm	mm	€	U	U
500	16	35	28	33,00	2	017040050
600	16	34	26	37,00	2	017040060
800	18	38	29	54,50	2	017040080

1704A

Koevoet met verharde punt, vervaardigd uit smeedstaal

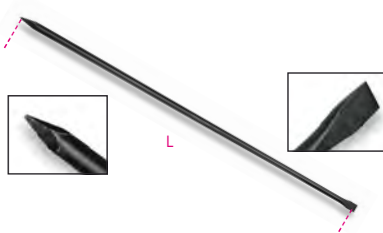

L mm	Ø mm	mm	€	U	U
1500	25	45	103,00	1	017040110
2000	25	55	134,50	1	017040120

1704C

Koevoet vervaardigd uit gelakt smeedstaal



L mm	8 mm	min-MAX mm	mm	€	U	U
1200	21-31	39		113,50	1	017040210
1400	31-37	42		134,50	1	017040212
1600	25-37	42		165,50	1	017040215

1705

Aftekenkoord vervaardigd uit aluminium



L m	€	U	U	
1705	30	22,40	4	017050001

1705PT

Talkpoeder

- container met dispenser
- blauw



g	€	U	U
250	14,90	5	017050025

1706DGT

Digitale profiel meter voor banden



1706DGT	€	U	U
	41,00	1	017060011

1707

Schroefdraadmeter

Voor ISO 60° metrisch en Whitworth 55° schroefdraad



P (ISO)	W	€	U	U
0,25+6	62÷4x1"	21,00	5	017070001

1707A/1-2-3

Straalkaliber, holle en bolle stalen bladen

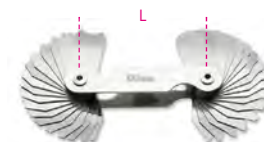

	R mm	L mm	n	€	U	U
1707A/1	1,0÷7,0	70	34	33,00	2	017070007
1707A/2	7,5÷15	85	32	35,50	2	017070015
1707A/3	15,5÷25	85	30	35,50	2	017070025

1708/8 - 13 - 20

Voelermaten metrisch



	€		
1708/8 S = 0,05÷0,50 mm	8,30	5	017080008
1708/13 S = 0,05÷1,00 mm	9,25	5	017080013
1708/20 S = 0,05÷1,00 mm	15,20	5	017080020

1709/10 - 1709/18

Moerenspijters



	L mm	A max mm	€		
1709/10	82,5	17 (M10)	61,50	1	017090010
1709/18	107,8	24 (M16)	68,50	1	017090018

1710

Hydraulische moerenspijter



	C min mm	C max mm	€		
7(M4)	7(M4)	22(M14)	274,00	1	017100001

1712E/1 - 2 - 3

Flexibele magneten

F = magnetische trekkracht



	L mm	D mm	F kg	€		
1712E/1	420	7,5	0,5	35,00	2	017120011
1712E/2	530	15	1,8	45,00	2	017120012
1712E/3	532	19	3,0	55,00	2	017120013

1712TF

Telescopische magneet met flexibele kop

• Met reinigingsnaald voor ruitensproeiers
F = magnetische trekkracht



	L mm	D mm	F kg	€		
150÷590	150÷590	11	1	25,00	1	017120600

1713M

Flexibele grijper

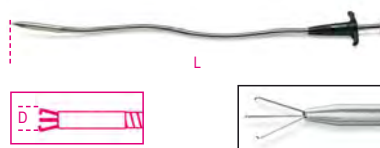

	L mm	D mm	€		
500	500	7	49,50	2	017130011
1000	1000	7	88,50	1	017130015

1713M/K7

kit van 7 inspectie tools voor onderdelen met 1/4" zeskantaandrijving

- kitinhoud:
- 1 telescopische hendel, lengte 185-660 mm
 - 1 rechthoekige inspectiespiegel, 65x43 mm
 - 1 ronde inspectiespiegel, Ø 52 mm
 - 1 magneet, Ø 16,3 mm
 - 1 ultrahelder LED-lampje
 - 1 flexibele grijper (item 1713M)
 - 1 magnetische koffer van roestvrij staal
 - 3 LR44-celbatterijen



	€		
1713M/K7	165,00	1	017130100

297x165x52 mm - 0,8 kg

1714

Inspectiespiegel vervaardigd uit kunststof



	L mm	D mm	€		
1714	155	25	4,00	5	017140001

1715

Inspectiespiegel verchroomd metalen greep



	L mm	D mm	€		
1715	180÷540	30	35,00	1	017150001

1715FL/A

Inspectiespiegel verchroomd metalen greep



	L mm	A mm	B mm	€		
1715FL/A	600	53	90	44,00	1	017150110

1715R/FL

2-delig sets spiegels voor artikelen 1715FL/A en 1715FL/B

	€		
1715R/FL	10,60	1	017150151

1715FL/B

Inspectiespiegel, flexibel met licht kunststof handgreep, verchroomd

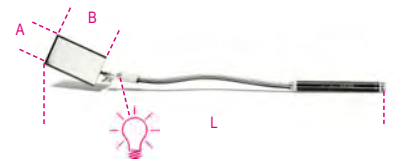

	L mm	A mm	B mm	€		
1715FL/B	553	53	90	58,00	1	017150115

1715B/R5L

5-delig set reserve lampjes voor artikel 1715FL/B

	€		
1715B/R5L	9,45	1	017150152

1715I

Telescopische inspectiespiegel met 5x vergrotingsfunctie

- Antislip PVC-handvat
- Spiegel en handgreep van roestvrij staal



	L mm	D mm	€		
1715I	250÷720	55	37,50	1	017150020

1715L

Telescopische inspectiespiegel met LED licht

- Behuizing gemaakt van roestvrij staal
- Zakformaat, met clip
- Geleverd met 3 batterijen van het type L736F



	L mm	D mm	€		
1715L	265÷765	50	52,50	1	017150005

1716A

Gebogen haak voor algemeen gebruik



	L mm	L1 mm	B mm	€		
1716A	240	125	6	13,60	3	017160040

1716P

Pakking schraper



L	L1	Ø	€	Stuks	Art. No.
mm	mm	mm			
250	125	6	16,50	3	017160020

1716R

Priem, rond stalen kling

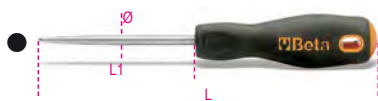

L	L1	Ø	€	Stuks	Art. No.
mm	mm	mm			
215	100	6	10,80	5	017160001

1716U

Haak voor algemeen gebruik



L	L1	Ø	€	Stuks	Art. No.
mm	mm	mm			
195	80	6	13,00	3	017160025

1717A

Schraapstalen, halfrond model



L	L1	L2	€	Stuks	Art. No.
mm	mm	mm			
150	70	260	24,40	2	017170015
200	75	310	26,00	2	017170020
250	100	360	27,50	2	017170025

1717B

Schraapstalen, driekantig model



L	L1	L2	€	Stuks	Art. No.
mm	mm	mm			
150	75	260	21,10	2	017170115
200	85	310	23,80	2	017170120
250	100	360	25,00	2	017170125

1717C

Schraapstalen, vlak model



L	S	L1	€	Stuks	Art. No.
mm	mm	mm			
150	18	270	20,10	2	017170215
200	20	320	23,00	2	017170220
250	25	370	24,80	2	017170225

1717D

Schraapstaal, vlak model



L	S	L1	€	Stuks	Art. No.
mm	mm	mm			
150	150	23	27,00	2	017170320

1717T

Driehoeks schraper, compleet met 2 messen



L	€	Stuks	Art. No.
mm			
310	12,90	1	017170610

1717T RT

Reserve driehoekig mes



L	€	Stuks	Art. No.
mm			
65	2,69	1	017170660

1717T RS

Reserve voorgevormd mes



€	Stuks	Art. No.
2,69	1	017170661

1717V

Verfschraper, mesjes kunnen aan meerdere kanten worden gebruikt



L	A	€	Stuks	Art. No.
mm	mm			
1717V 38	200 38	8,95	1	017170703
1717V 65	285 65	18,40	1	017170706

1717V R

Reserve messen voor artikel 1717V



L	€	Stuks	Art. No.
mm			
1717V R38	38	2,69	1 017170753
1717V R65	65	3,95	1 017170756

KAPVORM VAN WERKPLAATSVIJLEN

Basterd

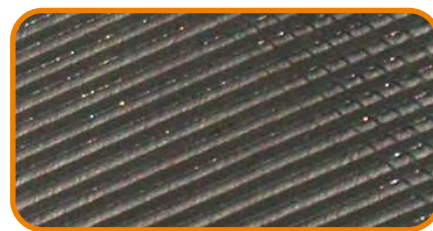

Halfzoet



Zoet



1718D...Q

Vierkante basterd vijlen, zonder handgreep

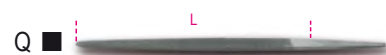

	L	L"	€	Stuks	Art. No.
	mm				
1718D6/Q	150	6	10,20	5	017180121
1718D8/Q	200	8	12,70	5	017180131
1718D10/Q	250	10	16,80	5	017180141

1718A...Q

Vierkante halfzoete vijlen, zonder handgreep



	L	L"	€	Stuks	Art. No.
	mm				
1718A6/Q	150	6	10,70	5	017180021
1718A8/Q	200	8	12,70	5	017180031
1718A10/Q	250	10	17,30	5	017180041

1718D...T

Driehoekig basterd vijlen, zonder handgreep



	L mm	L' "	€		
1718D6/T	150	6	12,70	5	017180123
1718D8/T	200	8	15,70	5	017180133
1718D10/T	250	10	20,70	5	017180143

1718A...T

Driehoekige halfzoete vijlen, zonder handgreep



	L mm	L' "	€		
1718A6/T	150	6	12,70	5	017180023
1718A8/T	200	8	16,10	5	017180033
1718A10/T	250	10	21,20	5	017180043

1718D...P

Platte basterd vijlen, zonder handgreep



	L mm	L' "	€		
1718D6/P	150	6	9,90	5	017180125
1718D8/P	200	8	11,40	5	017180135
1718D10/P	250	10	15,70	5	017180145

1718A...P

Platte halfzoete vijlen, zonder handgreep



	L mm	L' "	€		
1718A6/P	150	6	10,30	5	017180025
1718A8/P	200	8	11,80	5	017180035
1718A10/P	250	10	16,60	5	017180045

1718D...M

Halfronde basterd vijlen, zonder handgreep



	L mm	L' "	€		
1718D6/M	150	6	13,70	5	017180127
1718D8/M	200	8	16,80	5	017180137
1718D10/M	250	10	21,20	5	017180147

1718A...M

Halfronde basterd vijlen, zonder handgreep



	L mm	L' "	€		
1718A6/M	150	6	14,10	5	017180027
1718A8/M	200	8	17,10	5	017180037
1718A10/M	250	10	22,50	5	017180047

1718D...R

Ronde basterd vijlen, zonder handgreep



	L mm	L' "	€		
1718D6/R	150	6	9,90	5	017180129
1718D8/R	200	8	11,40	5	017180139
1718D10/R	250	10	15,20	5	017180149

1718A...R

Ronde halfzoete vijlen, zonder handgreep



	L mm	L' "	€		
1718A6/R	150	6	10,30	5	017180029
1718A8/R	200	8	12,20	5	017180039
1718A10/R	250	10	15,80	5	017180049

1718D...S5

5-delig set basterd vijlen, zonder handgreep



	L mm	L' "	€		
1718D6/S5	150	6	56,50	1	017180130
1718D8/S5	200	8	68,00	1	017180140
1718D10/S5	250	10	89,50	1	017180150

1718A...S5

5-delig set halfzoete vijlen, zonder handgreep



	L mm	L' "	€		
1718A6/S5	150	6	58,00	1	017180030
1718A8/S5	200	8	70,00	1	017180040
1718A10/S5	250	10	93,50	1	017180050

1719BMD...Q

Basterd vijlen, vierkant met handgreep



	L mm	L' "	€		
1719BMD6/Q	150	6	13,30	5	017190191
1719BMD8/Q	200	8	14,80	5	017190221
1719BMD10/Q	250	10	21,60	5	017190241
1719BMD12/Q	300	12	28,50	3	017190325

1719BMA...Q

Halfzoeten vijlen, vierkant met handgreep



	L mm	L' "	€		
1719BMA6/Q	150	6	14,00	5	017190021
1719BMA8/Q	200	8	16,30	5	017190052
1719BMA10/Q	250	10	23,00	5	017190071
1719BMA12/Q	300	12	31,00	3	017190311

1719BMX...Q

Zoete vijlen, vierkant met handgreep



	L mm	L' "	€		
1719BMX6/Q	150	6	15,20	5	017190022
1719BMX8/Q	200	8	18,60	5	017190053
1719BMX10/Q	250	10	24,70	5	017190072

1719BMD...T

Basterd vijlen, driehoek met handgreep



	L mm	L' "	€		
1719BMD6/T	150	6	15,80	5	017190193
1719BMD8/T	200	8	18,30	5	017190223
1719BMD10/T	250	10	26,00	5	017190243
1719BMD12/T	300	12	36,00	3	017190326

1719BMA...T

Halfzoeten vijlen, driehoek met handgreep



	L mm	L' "	€		
1719BMA6/T	150	6	16,40	5	017190023
1719BMA8/T	200	8	19,90	5	017190054
1719BMA10/T	250	10	27,00	5	017190073
1719BMA12/T	300	12	37,50	3	017190313

1719BMX...T

Zoete vijlen, driehoek met handgreep



	L mm	L' "	€		
1719BMX6/T	150	6	19,00	5	017190024
1719BMX8/T	200	8	24,70	5	017190055
1719BMX10/T	250	10	31,50	5	017190074

1719BMD...P

Basterd vijlen, plat met handgreep



	L mm	L "	€	U	L
1719BMD6/P	150	6	13,30	5	017190195
1719BMD8/P	200	8	14,10	5	017190225
1719BMD10/P	250	10	20,70	5	017190245
1719BMD12/P	300	12	27,00	3	017190327

1719BMA...P

Halfzoeten vijlen, plat met handgreep



	L mm	L "	€	U	L
1719BMA6/P	150	6	14,50	5	017190025
1719BMA8/P	200	8	16,20	5	017190056
1719BMA10/P	250	10	21,60	5	017190075
1719BMA12/P	300	12	29,50	3	017190315

1719BMX...P

Zoete vijlen, plat met handgreep



	L mm	L "	€	U	L
1719BMX6/P	150	6	14,90	5	017190026
1719BMX8/P	200	8	18,50	5	017190057
1719BMX10/P	250	10	25,50	5	017190076

1719BMD...M

Halfzoeten vijlen, half rond met handgreep



	L mm	L "	€	U	L
1719BMD6/M	150	6	17,40	5	017190197
1719BMD8/M	200	8	19,00	5	017190227
1719BMD10/M	250	10	26,50	5	017190247
1719BMD12/M	300	12	37,00	3	017190328

1719BMA...M

Halfzoeten vijlen, half rond met handgreep



	L mm	L "	€	U	L
1719BMA6/M	150	6	18,80	5	017190027
1719BMA8/M	200	8	21,30	5	017190058
1719BMA10/M	250	10	28,50	5	017190077
1719BMA12/M	300	12	40,00	3	017190317

1719BMX...M

Zoete vijlen, half rond met handgreep



	L mm	L "	€	U	L
1719BMX6/M	150	6	19,60	5	017190028
1719BMX8/M	200	8	24,70	5	017190059
1719BMX10/M	250	10	33,50	5	017190078

1719BMD...R

Basterd vijlen, rond met handgreep



	L mm	L "	€	U	L
1719BMD6/R	150	6	13,30	5	017190199
1719BMD8/R	200	8	14,20	5	017190229
1719BMD10/R	250	10	19,90	5	017190249
1719BMD12/R	300	12	26,00	3	017190329

1719BMA...R

Halfzoeten vijlen, rond met handgreep



	L mm	L "	€	U	L
1719BMA6/R	150	6	14,50	5	017190029
1719BMA8/R	200	8	16,10	5	017190060
1719BMA10/R	250	10	21,10	5	017190079
1719BMA12/R	300	12	28,50	3	017190319

1719BMX...R

Zoete vijlen, rond met handgreep



	L mm	L "	€	U	L
1719BMX6/R	150	6	16,70	5	017190031
1719BMX8/R	200	8	18,40	5	017190061
1719BMX10/R	250	10	24,70	5	017190081

1719BMA...B5

5 delig set halfzoeten vijlen, met handgreep, in etui



	L mm	L "	€	U	L
1719BMA8/B5	200	8	90,00	1	017190297
1719BMA10/B5	250	10	121,00	1	017190298

1719BMD...B5

5 delig set basterd vijlen, met handgreep, in etui



	L mm	L "	€	U	L
1719BMD8/B5	200	8	80,50	1	017190303
1719BMD10/B5	250	10	114,50	1	017190305

1719BMD...S5

5-delig set basterd vijlen met handgreep

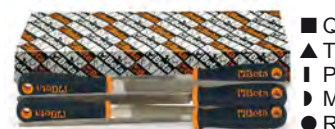

	L mm	L "	€	U	L
1719BMD6/S5	150	6	73,00	1	017190200
1719BMD8/S5	200	8	80,50	1	017190230
1719BMD10/S5	250	10	114,50	1	017190250
1719BMD12/S5	300	12	154,50	1	017190363

1719BMA...S5

5-delig set halfzoeten vijlen met handgreep



	L mm	L "	€	U	L
1719BMA6/S5	150	6	78,00	1	017190030
1719BMA8/S5	200	8	90,00	1	017190070
1719BMA10/S5	250	10	121,00	1	017190080
1719BMA12/S5	300	12	166,50	1	017190361

1719BMX...S5

5-delig set zoete vijlen met handgreep



	L mm	L "	€	U	L
1719BMX6/S5	150	6	85,50	1	017190032
1719BMX8/S5	200	8	105,00	1	017190069
1719BMX10/S5	250	10	140,00	1	017190082

1719BMB/P

Werkplaatsvijl, plat met kunststof handgreep

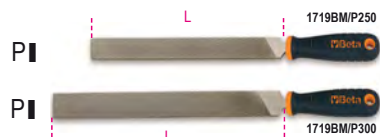

L mm	L"	€	Hand	Computer
250	10	32,50	5	017190152
300	12	38,50	5	017190153

1719BMC

Werkplaatsvijlen half rond en plat, kunststof handgreep



UNI 5569 - UNI 5568

	L mm	L"	€	Hand	Computer
1719BMC/M 250	250	10	22,10	6	017190252
1719BMC/M 300	300	12	27,00	4	017190253
1719BMC/P 250	250	10	18,30	6	017190262
1719BMC/P 300	300	12	22,00	4	017190263

1719BM/RL

platte rasp/vijl
1 tweede snede raspzijde,
1 ruwe vijlzijde
kunststof handvat



	L mm	L"	€	Hand	Computer
1719BM/RL	200	8	17,30	5	017190360

1719BM/RR

ronde rasp,
kunststof handvat



	L mm	L"	€	Hand	Computer
1719BM/RR	200	8	17,80	5	017190351

1719BM/RG

Halfronde rasp, kunststof handvat



	L mm	L"	€	Hand	Computer
1719BM/RG	200	8	17,00	5	017190353

1719BM/RP

Platte rasp, kunststof handvat



	L mm	L"	€	Hand	Computer
1719BM/RP	200	8	18,00	5	017190352

1719BMR/B3

Set van 3 raspen met handvat in etui



	L mm	L"	€	Hand	Computer
1719BMR/B3	200	8	53,00	1	017190358

1719BMR

Handgrepen voor vijlen



	L mm	A mm	€	Hand	Computer
1719BMR/0	95	25	4,00	10	017190950
1719BMR/0B	110	29	4,00	10	017190955
1719BMR/1	110	29	4,00	10	017190951
1719BMR/1B	110	29	4,00	10	017190953
1719BMR/2	123	31	4,00	10	017190952
1719BMR/2B	123	31	4,00	10	017190954

	mm	"	
1719BMR/0	100/150	4/6	▲▲
1719BMR/0B	100/150	6/8	●●
1719BMR/1	150/200	6/8	▲▲
1719BMR/1B	150/200	6/8	●●
1719BMR/2	250/300	10/12	▲▲
1719BMR/2B	250/300	10/12	●●



1720/...

Naaldvijen,
schacht Ø 3 mm

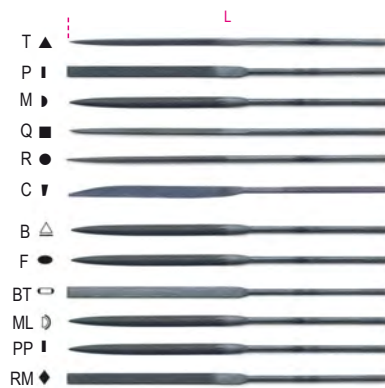

UNI 5569 UNI 5670

	L mm	€	Hand	Computer
1720T	160	7,85	5	017200004
1720P	160	7,85	5	017200006
1720M	160	7,85	5	017200008
1720Q	160	7,85	5	017200009
1720R	160	7,85	5	017200010
1720C	160	7,85	5	017200012
1720B	160	7,85	5	017200005
1720ML	160	7,85	5	017200007
1720BT	160	7,85	5	017200011
1720F	160	7,85	5	017200013
1720PP	160	7,85	5	017200014
1720RM	160	7,85	5	017200015



	€	Hand	Computer
1720/S3	23,60	1	017200000

1720/B



	€	Hand	Computer
1720/B6	49,50	1	017200002
1720/B12	94,00	1	017200003

1720D/...

Diamant naaldvijen
korrel D126



	L mm	€	Hand	Computer
1720D/T	160	53,00	2	017200104
1720D/P	160	53,00	2	017200106
1720D/M	160	53,00	2	017200108
1720D/Q	160	53,00	2	017200109
1720D/R	160	53,00	2	017200110
1720D/C	160	53,00	2	017200112



1720D/B6 € 321,00 1 017200120

1721/B6

6-delig set contactpuntvijen in kunststof etui



1721/B6 € 25,00 1 017210010

1723

Veertrekker



1723 L mm 210 € 17,30 5 017230001

1725

Zaagbeugel



1725 L mm 420 L1 mm 300 € 25,00 4 017250001

1725CR

Mini zaagbeugel



1725CR L mm 250 L1 mm 150 € 14,50 5 017250010

1726

Zaagbeugel, zaagbladspanner in de handgreep

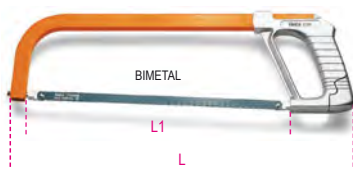

1726 L mm 440 L1 mm 300 € 35,00 4 017260001

1726BM

Zaagbeugel met snelwissel mechanisme voor zaagbladen



1726BM L mm 400 L1 mm 300 € 57,50 1 017260050

1727

Zaagbeugel, zware uitvoering

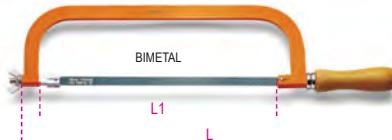

1727 L mm 515 L1 mm 300 € 25,50 4 017270001

1727BM

Zaagbeugel, een hands greep



1727BM L mm 315 L1 mm 300 € 29,00 5 017270020

1728...

Zaagbladen voor zaagbeugels



1728LA € 1,80 100 017280001

1725CR € 4,20 100 017280010

1725MQ € 4,20 100 017280010

1728BM 1725-1726 € 5,70 50 017280030

1727-1727M € 5,70 50 017280030

1728CO 1725-1726 € 5,70 50 017280030

1727-1727M € 5,70 50 017280030

1729CG

Gipsplaat zaag



1729CG L mm 310 L1 mm 160 € 28,50 2 017290200

1729DM 450

Houtzaag

Medium vertanding, 12 tanden/inch



1729DM 450 L mm 450 L1 mm 400 € 33,50 4 017290450

1730

Plamuurmes, met roestvaststalen messen en handvatten



S mm	L mm	L1 mm	€		
38	210	85	6,70	2	017300038
63	220	95	8,10	2	017300063
75	220	95	8,85	2	017300075
100	220	95	10,20	2	017300100

1730M

Paletmessen, met roestvast stalen messen en handgrepen



L1 mm	L mm	S mm	€		
150	245	27	9,40	2	017300215
200	330	28	17,80	2	017300220
250	365	36	21,90	2	017300225

1730V 38

Stopmes lemmet vervaardigd uit roestvast staal



1730V 38 S mm 38 L mm 225 L1 mm 100 € 6,80 2 017300338

1736A

Vijlenborstel
Roestvaststalen draden,
draad Ø: 0.5 mm



1736A L mm 240 € 12,40 10 017360010

1737

Bougie borstel, gegolfde koperdraden, draad Ø: 0.2 mm



1737	L mm	€		
	145	5,80	10	017370001

1737NX

Remschoen borstel, koperen staaldraden, draad Ø: 0.3 mm



1737NX	L mm	€		
	270	6,80	5	017370010

1737AC

Staalborstel, 5 rijen, draad Ø: 0.3 mm



1737AC	L mm	€		
	275	6,65	5	017370020

1737B

Staaldraad borstel voor het reinigen van de accupool en en poolhouders draad Ø: 0.3 mm



1737B	€			
	17,40	1		017370050

1738

Borstel



1738	L mm	H mm	€		
	210	30	9,80	10	017380001

1739C

Blindklinktang schaarmodel, geleverd met 5 verwisselbare mondstukken



Ø mm	3,2	4	4,8	5	6	6,4
Aluminium	•	•	•	•	•	•
Roestvrij staal	•	•	•	•	•	•
L max mm	810					
1739C	€					
	90,00	1				017390152

1740AN

Heavy-duty blindklinktang, met 5 verwisselbare mondstukken
Compleet met rivet opvangbak



Ø mm	3,2	4	4,8	5	6	6,4
Aluminium	•	•	•	•	•	•
Roestvrij staal	•	•	•	•	•	•
L mm	530					
1740AN	€					
	120,00	1				017400103

1740B

Compacte industriële blindklinktang, geleverd met 5 verwisselbare mondstukken



Ø mm	2,4	3	3,2	3,2	4,8
Aluminium	•	•	•	•	•
Roestvast staal	•	•	•	•	•
Inox	•	•	•	•	•
L mm	280				
1740B 280	€				
	85,00	1			017400280

Ø mm	2,4	3,2	4,0	4,8	6,4
Aluminium	•	•	•	•	•
Roestvast staal	•	•	•	•	•
Inox	•	•	•	•	•

1740B 330	L mm	€		
	330	96,00	1	017400330

1741B

Blindklinktang met 4 verwisselbare mondstukken



Ø mm	2,4	3,2	4	4,8	5
Aluminium	•	•	•	•	•
Steel	•	•	•	•	•
Stainless steel	•	•	•	•	•

1741B	€			
	44,50	1		017410000

1741B/C5

Blindklinktang 1741B met een 700-delig assortiment aluminium nagels



1741B/C5	€			
	143,50	1		017410025

	Ø mm	L mm	n.
1741RV2,9K	3,0	6	200
1741RV3,2K	3,2	8	200
1741RV3,8K	4,0	10	100
1741RV4K	4,0	12	100
1741RV4,8K	4,8	12	100

415x155x60 mm - 3,1 Kg



1741BP

Blindklinktang met 4 verwisselbare mondstukken



Ø mm	2,4	3,2	4	4,8	5
Aluminium	•	•	•	•	•
Steel	•	•	•	•	•
Stainless steel	•	•	•	•	•

1741BP € 67,00 1 017410350

1741U

Ultra compacte blindklinktang met instelbare kracht
en 4 verwisselbare bekken
3 klauwen: verbeterde nagelgrip



Ø mm	2,4	3	3,2	4	4,8
Aluminium	•	•	•	•	•
Staal	•	•	•	•	•
Roestvast staal	•	•	•	•	•

1741U € 52,50 1 017410450

1741RV...K

Aluminium nagels



1741RV 2,9K	€ 23,40	1 017410191
1741RV 3,2K	24,10	1 017410192
1741RV 3,8K	32,00	1 017410193
1741RV 4K	34,00	1 017410194
1741RV 4,8K	42,50	1 017410195

De afgebeelde prijzen zijn per 500 stuks.

1742N

Blindklinktang voor blindklinkmoeren, met 4 verwisselbare mondstukken (1x M3;M4;M5;M6)



1742N € 80,00 1 017420002

	Ø mm	L mm
3	5	11
4	6	11
5	7	13
6	9	17

1742N/KR

Set van 4 reserve mondstukken voor artikel 1742N



M3	€ 50,00	1 017420063
M4	50,00	1 017420064
M5	50,00	1 017420065
M6	50,00	1 017420066

1742R-AL/M...

Aluminium nagels met draad voor artikelen 1742-1742A-1946KF



1742R-AL M3	€ 5,75	1 017420023
1742R-AL M4	5,85	1 017420024
1742R-AL M5	6,20	1 017420025
1742R-AL M6	7,90	1 017420026

De afgebeelde prijzen zijn per 20 stuks.

1742R-A/M...

Stalen nagels met draad voor artikelen 1742-1742A-1946KF



1742R-A M3	€ 5,90	1 017420013
1742R-A M4	6,40	1 017420014
1742R-A M5	6,65	1 017420015
1742R-A M6	7,85	1 017420016
1742R-A M8	7,00	1 017420018
1742R-A M10	9,30	1 017420020
1742R-A M12	9,50	1 017420022

De afgebeelde prijzen zijn per 20 stuks.
* De afgebeelde prijzen zijn per 10 stuks.

1742N/C4

Blindklinktang 1742N met assortiment van 400 stalen nagels



1742N/C4 € 265,00 1 017420006

	M	Ø mm	n.
1742R-A/M3	3	5	100
1742R-A/M4	4	6	100
1742R-A/M5	5	7	100
1742R-A/M6	6	9	100

415x155x60 mm - 2,9 kg

1742AN

Heavy-duty Blindmoertang, met 7 verwisselbare mondstukken



1742AN € 330,00 1 017420101

M	Ø mm	L mm
5	7	13
6	9	17
8	11	17
10	13	24

1742AN/KR

Set met 4 reserve mondstukken voor artikel 1742AN



	€		
1742AN/KR M3	M3	30,00	1 017420153
1742AN/KR M4	M4	30,00	1 017420154
1742AN/KR M5	M5	30,00	1 017420155
1742AN/KR M6	M6	30,00	1 017420156
1742AN/KR M8	M8	30,00	1 017420158
1742AN/KR M10	M10	30,00	1 017420160
1742AN/KR M12	M12	30,00	1 017420162

1742AN/C

Heavy-duty Blindmoertang 1742AN met assortiment van 80 stalen nagels



	€		
1742AN/C	399,00	1	017420106

	M	Ø mm	n.
1742R-A/M5	5	7	20
1742R-A/M6	6	9	20
1742R-A/M8	8	11	10
1742R-A/M10	10	13	10

420x240x80 mm - 2,5 kg

1749

Kitspuit gelakt metalen houder



	L min mm	€		
1749	340	15,70	2	017490001

1749A

Kitspuit, professioneel model aluminium koker



	L min mm	€		
1749A	360	49,50	1	017490010

1749A/RB

Reserve mondstukken voor artikel 1749A

	€		
1749A/RB	1,28	1	017490051

1749A/RT

Voorste afsluitmoer voor artikel 1749A

	€		
1749A/RT	2,95	1	017490052

1749AC

Kitspuit voor chemische verankering



	L min mm	€		
1749AC	360	44,00	1	017490005

1750

Schaarvetspuit

Te gebuiken met vetpatronen 1750CG of los vet



	1750CG cc	L mm	€		
	400	380	50,00	1	017500500
	600	450	61,50	1	017500750

1750R/1 - 1750R/2

Flexibel mondstuk vervaardigd uit Nylon



	L mm	€		
1750R/1	310	8,30	2	017500030
1750R/2	410	9,40	2	017500040

1750RC

Gebogen vast mondstuk



	L mm	M mm	€		
1750RC	150	10x1	6,85	2	017500050

1750RT

4 beks vetnippel "hydraulische" model



	M mm	€		
1750RT	10x1	5,90	5	017500110

1750RP/1 - 1750RP/2

Vetnippels voor platte aansluitingen



	Ø mm	M mm	€		
1750RP/1	16	10x1	16,20	2	017500115
1750RP/2	22	10x1	35,50	2	017500120

1750CG

Vetpatronen voor model 1750



	cc	€		
	400	18,30	18	017500140
	600	23,00	18	017500160

1750KG10

Vetafgifte pomp met pistool, 10 kg, met hogedruk slang, 2 m

Compleet met een draaibare koppeling waarmee het verward raken van de slang uitgesloten is.
Gegoten aluminium behuizing met controle klep

3 verschillende druk niveaus zijn beschikbaar:

- 4 g bij 275 bar
- 7 g bij 206 bar
- 9 g bij 137 bar



312,5 mm

1750KG10 € 227,50 1 017500100

1750TA

Hoge druk, zelfklemmende 6 pins mondstuk

Enmaals geplaatst, blijft het op de vetnippel zitten; deze hoeft niet meer worden vastgehouden zoals bij de standaard vetnippels

Eenvoudig af te koppelen, zelfs wanneer het mondstuk onder druk staat.

Draad type M10x1: geschikt voor alle type vetspuiten: elektrisch, pneumatisch, handmatig enz.

Beschermd tegen vervorming tot 550 bar



17 mm
30 mm

1750TA € 59,00 1 017500111

1750TLA

Hogedruk, zelfklemmende 6 pins mondstuk, lange uitvoering

• Enmaals geplaatst, blijft het op de as zitten en verbonden met de nippel

• Eenvoudig af te koppelen, zelfs met een onder druk staand mondstuk

• Draad M10x1: geschikt voor alle type vetspuiten: elektrisch, pneumatisch, hand, enz.

• Beschermd tegen vervorming tot 550 bar



17 mm
80 mm

1750TLA € 73,50 1 017500112

1750M

Mini vetspuit

- Met micro vetnippel
- Zeer geschikt voor perslucht gereedschap



Ø 0,5 mm

Ø

	cc	D mm	L mm	€		
1750M	100	43	145	26,50	1	017500025

1750M3

mini-vetspuit, met 3 mondstukken

• voorzien van drie verwisselbare mondstukken: 0,7 - 1,0 - 1,4 mm

• bijzonder geschikt voor het smeren van pneumatisch gereedschap

• kan gebruikt worden met los vet

• geschikt voor gebruik van vet tot klasse NLGI 2



Ø 0,7 mm

Ø 1,0 mm
Ø 1,4 mm

Ø

	cc	Ø mm	L mm	€		
1750M3	85	42	160	35,50	1	017500003

1751CR

Metalen oliekan met pomp, flexibele tuit



L

D

	cc	D mm	L mm	€		
200	62	140	15,00	4	017510202	
300	75	140	16,00	4	017510203	
500	85	140	16,50	4	017510205	
700	100	140	17,50	2	017510207	
1000	100	140	19,50	2	017510210	

1751N

metalen oliekannen met pomp, flexibele tuit



L

D

	cc	D mm	L mm	€		
200	62	140	19,70	4	017510020	
300	75	140	21,40	4	017510030	
500	85	140	22,40	4	017510050	
700	100	140	24,30	2	017510075	
1000	100	140	26,50	2	017510100	

1752

kunststof oliekannen met pomp, vaste tuit



L

D

	cc	D mm	L mm	€		
200	67	140	13,10	4	017520002	
300	77	140	13,70	4	017520003	
500	95	140	14,40	4	017520005	

1754

Kunststof oliekannen met pomp flexibele kunststof tuit



130 mm

D

	cc	D mm	L mm	€		
150	60	130	10,90	5	017540015	
250	65	130	12,10	5	017540025	

1755C

Kunststof oliekan, gebogen tuit



cc	L mm	A mm	€		
125	110	46	7,50	5	017550112
250	110	60	8,50	5	017550125
500	110	74	9,50	4	017550150

1756

oliespuit penmodel

geschikt voor gebruik met minerale oliën



cc	L mm	€		
5	140	27,50	2	017560001

1756B

oliespuit penmodel

- met antislip grip
- bedrijfstemperatuur: -10 °C - +60 °C
- minimale dichtheid van SAE 10 olie



cc	L mm	€		
500	280	26,00	2	017560220

1756C

oliespuit, 200ml, vervaardigd uit polypropyleen

- ook geschikt voor remsysteemvloeistof
- dubbele EPDM pakking
- bedrijfstemperatuur: +0 °C ÷ +50 °C
- bruikbare minimale oliedichtheid; ISO 150, SAE 90 (versnellingsbakolie), SAE 40 (motorolie)



€		
41,00	1	017560502

1756D

Oliespuit, 1500 ml, vervaardigd uit polypropyleen

- Dubbele NBR pakking
- Werk temperatuur: +0 - +50 °C
- NIET geschikt voor brandstof

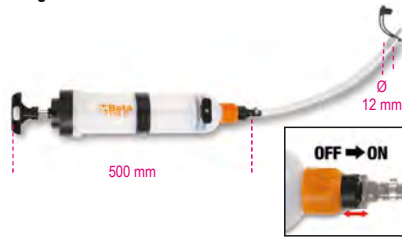

€		
91,50	1	017560515

1756E

Oliespuit, geschikt voor benzine



€		
49,00	1	017560610

1756G

Diesel oliespuit capaciteit: 1.5 l

- Is geschikt voor:
- het vullen van diesel olie filters
 - het vullen van DPF tank



- Set omvat:
- 2 slangen met snelkoppeling voor het aansluiten op dieselolie slangen
 - 2 insteekkoppelingen, vervaardigd uit metaal
 - 1 kegelvormige adapter voor rubberen slangen

€		
137,50	1	017560615

1756C-2OR

O-ringen (paar) voor oliespuit artikel 1756C

€		
5,40	1	017560503

1756D-2OR

O-ringen (paar) voor oliespuit artikel 1756D

€		
10,40	1	017560516

1757

Accu vulspuit



cc	D mm	€		
250	60	4,70	4	017570002
500	75	5,60	4	017570004
1000	90	7,80	2	017570006

1757A

Accuvuller



cc	€		
2000	49,00	1	017570020

1758

Zelfklemmende trechter

Zeer geschikt voor personenwagens waar geen diepe vulopening aanwezig is



€		
61,00	1	017580020

1758ADB-D

Vultrechter voor AdBlue®, anti terugslag met rechte aansluiting



I Max	€		
1	39,00	1	017580050

1758ADB-45°

Vultrechter voor AdBlue®,
anti terugslag met 45° aansluiting



1758 ADB-45
I
Max 1
€ 42,50
1 017580060

1758A

Trechter met bajonetsluiting en
anti-lek mechanisme, Ø 38 mm
Voor Volkswagen groep auto's



1758A
€ 85,50
1 017580010

1758B

Vultrechter, anti-terugslag
met snelsluitingen
Zeer geschikt voor
VAG automobielen



1758B
€ 40,50
1 017580030

1758B-1,6

ant-terugslagtrechter, 1600 ml,
met snelkoppelingen
snelkoppelingen
voor VAG-groepsvoertuigen



H1 H2 Ø
mm mm mm
1758B-1,6 125 100 155
€ 46,50
1 017580033

1758B-RNT

Anti terugslag koppelstuk
voor trechter artikel 1758B - 1758B-1,6

Voor Renault 1.5 dCi motor



1758B-RNT
€ 29,00
1 017580035

1758B/K5

set met anti-terugslag kleppen
snelkoppelingsadapters,
voor trechter 1758B - 1758B-1,6

set-inhoud:

- 1 adapter voor 1.5 dCi Renault-, Dacia-, Nissan-motoren
- 1 adapter voor 1.5/1.6 dCi Renault, Dacia, Nissan motoren
- 1 adapter voor 3.0 BMW dieselmotoren
- 1 adapter voor 1.5/2.0 benzinemotoren, VAG-groep
- 1 verbindingadapter voor trechter, met kraan



1758B/K5
€ 119,50
1 017580040

1758RD

Koelvloeistofrechter met snelkoppelingen



H Ø
mm mm
1758RD 248 172
€ 135,00
1 017580070

1758S

Wandmontagesteun voor trechter 1758 en
snelkoppelingen



1758S
€ 95,00
1 017580080

1758LG

Vormbare, voorzien van rubber coating,
aluminium trechter,
voor het geleiden van vloeistoffen



L H
mm mm
1758LG 365 168
€ 53,50
1 017580006

1758M

Trechter



L
mm
1758M 350
€ 16,30
1 017580000

1758R

Vulkannen

Gemakkelijk, afneembare en flexibele tuit



	lt	€		
1758R 1	1	10,80	1	017580201
1758R 2	2	12,60	1	017580202
1758R 3	3	22,60	1	017580203
1758R 5	5	27,00	1	017580205

1758VT

Cilinderkop testset

Contrast vloeistof maakt een snelle controle mogelijk of het expansievat enig kooldioxide bevat.



1758VT	€ 205,50	1	017580100
--------	----------	---	-----------

≡ 290x190x50 mm - 1 kg

1758VT/L

Contrast vloeistof voor het testen van cilinderkoppen



1758VT/L	€ 58,50	1	017580101
----------	---------	---	-----------

1759

Optisch meetapparaat voor koelmiddel, accuzuur, ruitenreiniger en AdBlue® vloeistoffen

Geleverd in harde koffer

Automatische temperatuur correctie

Accuzuur meetbereik: 1.1±1.3 kg/l

Propyleen koelmiddel: -25 °C ÷ -50 °C

Ethyleen koelmiddel: -25 °C ÷ -50 °C

Ruitensproeier vloeistof: -25 °C ÷ -40 °C

AdBlue: Urea percentage meting: 30% ÷ 45%



1759	€ 190,00	1	017590251
------	----------	---	-----------

1759A

Antivriesweger glazen cilinder



1759A	L mm 340	€ 78,50	1	017590001
-------	----------	---------	---	-----------

1759B

Accu zuurweger glazen cilinder



1759B	L mm 280	€ 53,00	1	017590005
-------	----------	---------	---	-----------

1759HD/3

Koelsysteem test en vul apparaat

• Maakt het mogelijk om het koelsysteem te controleren (slangen, koppelingen, pompen radiatoren) op lekkagen onder druk en het snel vullen van het koelsysteem zonder dat er luchtballen ontstaan.



1759HD/3	€ 659,00	1	017590063
----------	----------	---	-----------

≡ 600x500x140 mm - 6,5 kg

1759HD/RR

Koelsysteem vulapparaat



1759HD/RR	€ 203,50	1	017590064
-----------	----------	---	-----------

≡ 450x310x110 mm - 2,2 kg



1759LR

Koelsysteem spoelapparaat

gebaseerd op het gebruik van perslucht, Hoge waterdruk zorgt voor effectief spoelen van het reinigingssysteem

- Geleverd met 6-systeem adapters
- Bedieningshendel met positievergrendeling voor continu gebruik
- Geleverd met water-koppeling



1759LR 402 mm € 503,00 1 017590070
390X330X100

1759HD/TRUCK

Apparaat voor het testen en vullen van het koelsysteem bij vrachtautos



1759HD/TRUCK € 458,00 1 017590065
440x330x100 mm - 3 kg

1759TT

Kit van 4 paar koppelingen voor het testen van het turbo circuit, met behulp van bandenpomp



1759TT € 238,50 1 017590300
400x160x100 mm - 1,8 kg

CERTIFICATIESERVICE VOOR ELEKTRONISCHE INSTRUMENTEN

Certificering van elektronische meetinstrumenten als multimeters, metrische ampere klemmen, **tachometers en thermometers** is essentieel in de sectoren of toepassingsgebieden waar nauwkeurige, eenduidige, herkenbare metingen vereist zijn.

Voor infraroodthermometers wordt een 4-punts kalibratierapport (minimum, maximum en twee tussenliggende punten) met ENAC-traceerbaarheid uitgegeven.

Op verzoek levert Beta Utensili S.p.A. de certificeringsservice. Neem voor deze service contact op met uw dealer.



1760DGT

Digitale automotive multimeter

CE



195 mm



92 mm

TECHNISCHE SPECIFICATIES:

RPM (tachometer):
 VOOR 2 EN 4 cilinder motoren
 RPM4 600 - 4000 RPM
 RPM4 600 - 12000 RPM (x10 RPM)
 RPM2/DIS 300 - 4000 RPM
 RPM2/DIS 300 - 6000 RPM (x10 RPM)
 Contacthoek: 4-8 CYL
 Spanning DC: 400mV-4/40/400/1000V
 Spanning AC: 4/40/400/700V
 Ampere DC: 40/400mA-4/20A
 Ampere AC: 40/400mA-4/20A
 Weerstand: 400Ω-4/40/400kΩ-4/40MΩ
 Capaciteit: 40/400nF-4/40/100μF
 Frequentie: 5/50/500Hz-50/500-10MHz
 Arbeidstijd: 0.1% - 99.9%
 Gelijk en wisselstroom: 1 - 10ms
 Diode test: Test stroom 0.3mA
 Continuïteit: <150Ω - Test stroom <0.3mA
 Scherm: Hoog-contrast, verlicht 4-digit LCD
 Overvoltage: Category II 1000V
 Automatisch uitschakeling: 30 minuten
 Voeding: 1.9V batterij (meegeleverd)
 Inductieve klem (meegeleverd)
 2 sensoren (meegeleverd)
 Zachte opbergtas (meegeleverd)
 Gebruiksaanwijzing

1760DGT € 280,00 1 017600005



1760DGT/2

Digitale automatische multimeter, draagbaar, met een 2-kanaals oscilloscoop en golfvorm generator



CE

SET BEVAT:

- Multimeter pennen
- 2 BNC krokodillen klemmen voor oscilloscoop
- Sonde voor oscilloscoop (1X and 10X)
- Batterij lader
- Nylon opbergtas

TECHNISCHE DATA

Scherm: 2.8" kleur TFT
Resolutie: 320 x 240 pixels
Voeding: 100V-240V AC, 50Hz-60Hz; DC INPUT 5V DC-2A
Batterij: 2 x 2600 mAh

MULTIMETER SPECIFICATIES

Testen: spanning, stroom, weerstand, capaciteit, diodes en aan-uit
Max. spanning: 600V AC-DC
Max. stroom: 10A AC-DC
Max. weerstand: 40MOHM
Max. capaciteit: 100uF

OSCILLOSCOOP SPECIFICATIES

Horizontaal
Bandbreedte: 40 MHz
Bemonsteringsfrequentiebereik: 250MSa / s (enkel kanaal) - 125MSa / s (dubbel kanaal)
SEC / DIV-bereik: 5ns / div ÷ 500s / div 1,2,5-reeks
Verticaal
VOLTS / DIV-bereik: 10mV / div ÷ 10V / divat BNC-ingang
Selecteerbaar analoog, bandbreedtelimiet, typisch: 20 MHz
Lage frequentierespons (-3db): ≤10Hz een BNC
DC-versterkingsnauwkeurigheid: ± 3% voor normale of gemiddelde acquisitiemodus, 10V / div ÷ 10 mV / div
In gang zetten
Type: Edge
Modus: Auto, Normaal, Single
Helling: Rising, Falling, Rising & Falling
Bron: CH1, CH2
Invoer
Koppeling: DC, AC of GND
Ondersteunde sonde-dempingsfactoren: 1X, 10X, 100X, 1000X
Willekeurige golfvormgenerator
Golfvormfrequentie: Sinus (1 Hz ÷ 25 MHz), Vierkant (1 Hz ÷ 10 MHz), Ramp (1 Hz ÷ 1MHz), EXP (1 Hz ÷ 5 MHz)
Breedte: 2,5Vpp (50Ω) - 5Vpp (hoge impedantie)
Uitgangsimpedantie: 50Ω

Afmetingen: 199 x 98 x 40 mm
Gewicht: 624 gram

Dimensions: 199 x 98 x 40 mm
Weight: 624g

1760DGT/2 € 825,00 1 017600008

1760B

Digitale multimeter



CE

SPECIFICATIE

DC spanning: 200 mV-2/20/200/1000V
AC spanning: 2-20/200/700V
DC ampere: 2/20/200 mA-20 A
AC ampere: 2/200 mA- 20 A
Weerstand: 200Ω - 2/20/200 kΩ - 2/20 MΩ
Capaciteit: 2/20/200 nF - 2/200 μF
Temperatuur: -20° + 1000°C/-4 °F ~ +2000°F
Frequentie: 20kHz
Voeding: 1 9V batterij (meegeleverd)

1760B € 190,00 1 017600012

1760/OHM

Multimeter/Ohmmeter voor hoog voltage isolatie testen.
TRUE RMS indicator



CE

CAT. IV
600V
CAT. III
1000V

Meetbereik Basis nauwkeurigheid
AC/DC spanning: 50mV - 1000V ±0.06% - ±0.1% rdg
AC/DC stroom: 0.01μA - 10A ±0.5% - ±1% rdg
Weerstand: 0.01Ω - 50MΩ ±0.2% - ±2% rdg
Meg OHM: 0.01 - 5000MΩ ±4% Uitlezen max.
stroom 1mA
Capaciteit: 5nF - 10mF ±1.5% - ±3% rdg
Frequentie: 50Hz - 100 MHz ±0.02% - ±0.1% rdg
Temperatuur: -50 °C - +1350 °C ±0.5% uitlezen
Diode test: 3V dc
Continuïteitstest: <30 Ω

1760/OHM € 895,00 1 017600025

1760/RMS

Industriële digitale multimeter

EN61010-1
EN61326-1



CE

Meetbereik AC/DC spanning: 110mV - 600V ±0.8% - ±2% rdg
AC/DC ampere: 110μA - 10A ±1.5% - ±2% rdg
Weerstand: 110Ω - 40MΩ ±1.2% - ±2.5% rdg
Capaciteit to 11mF: 11nF - 40mF ±5% - ±10% rdg (up to 11mF)
Frequentie rdg: 1100Hz - 110 MHz ±1.2% - ±1.5%
Temperatuur: -32°C - +1000°C ±3% - ±5% rdg
Diode test, 3V DC ±10% rdg
Continuïteit test: <30 Ω -

1760/RMS € 350,00 1 017600020

1760S

Compacte digitale multimeter

TRUE RMS (effectieve waarde) lezen



CE

Meetbare parameters:
DC Voltage: 200 MV-2 / 20/200 / 600V
AC Voltage: 100 / 600V
DC-stroom: 200 MA-10 A
AC-stroom: 0,01-10 A
Weerstand: 200Ω - 2/20/200 KΩ - 2 MΩ
Diodetest: 0,4 ÷ 0,7
Voeding: 2 1.5V-batterijen, type AAA

1760S € 97,50 1 017600022

153x75x42 mm

1760PA/80

AC/DC ampere klem 80A

Ontworpen om lekstroom te meten bij laagstroom of de eigen stroom afname van het voertuig



CE

- Bereik: 1mA-80A AC/DC
- Lamp met wit LED licht
- Verlicht LCD scherm
- Nulinstelling functie
- Geheugen functie
- Automatische uitschakeling
- Voeding: 2 1.5V AAA-type batterijen

1760PA/80 € 250,00 1 017600002

1760PA/AC

Multimeter en ampereklem.

A: AC
V: AC/DC



CE

Specificaties
Spanning DC: 400 mV - 4/40/400/600 V
Spanning CA: 400 mV - 4/40/400/600 V
Ampere CA: 40/400/1000 A
Weerstand: 400Ω - 4/40/400 kΩ - 4/40 MΩ
Frequentie: 5/50/500 Hz - 5/50/500 kHz - 5/10 MHz
Capaciteit: 40/400 nF - 4/40/100 μF
Temperatuur: -20 °C + 1000 °C / -4 °F + 1832 °F
Voeding: 1 x 9V batterij (inclusief)

1760PA/AC L mm 190 € 210,00 1 017600050

1760PA/AC-DC

Digitale multimeter en ampereklem

A: AC/DC
V: AC/DC



CE

A: AC/DC
V: AC/DC

SPECIFICATIES
DC spanning: 0.1mV ÷ 600V
AC spanning: 0.1mV ÷ 600V
AC ampere: 0.01A ÷ 1000A
DC ampere: 0.01A ÷ 1000A
Weerstand: 0.1Ω ÷ 40MΩ
Capaciteit: 0.001nF ÷ 40 μF
Frequentie: 0.001kHz ÷ 4kHz
Temperatuur: -40°C ÷ 1000 °C
 -40°F ÷ 1832°F

1760PA/AC-DC € 350,00 1 017600000

1760PA/AC-DC2000

Ampereklem met digitale multimeter en Bluetooth-verbinding

TRUE RMS-functie in AC-assortiment

A: AC/DC
V: AC/DC



CE

Meetbare parameters:
 • DC-spanning: 0.1mV ÷ 1000V
 • AC-spanning: 0.1mV ÷ 1000V
 • AC-stroom: 0.01A ÷ 2000A
 • DC-stroom: 0.01A ÷ 2000A
 • Weerstand: 0,1Ω ÷ 60mΩ
 • Capaciteit: 1nF ÷ 6000 μF
 • Frequentie: 10kHz ÷ 20kHz
 • Temperatuur: -20 °C + 1000 °C -4 °F + 1832 °F
 • Voeding: 3 1.5V-batterijen, type AA (inbegrepen)
 • Bluetooth-verbinding (versie 4.0)

H mm 300 L mm 110 P mm 43 € 730,00 1 017600003

380x280x100 mm - 1,78 kg

1760DGT-R3

Reserve steekpennen voor digitale multimeters en ampereklemmen



1760DGT-R3 € 27,00 1 017600603

1760/RSE

Signaal detector

Maakt het mogelijk het elektrische voedingssignaal te testen van de afzonderlijke delen, inclusief common rail elektrische-injectoren, benzine/LPG elektrische-injectoren, piezoelektrische injectoren, stroom regelende magneetkleppen, EGR magneetkleppen en convertoren.



CE

Voor het stellen van een diagnose van de afzonderlijke delen van het elektrische systeem is het in de nabijheid brengen van de sonde bij het te testen onderdeel voldoende.

Bij systemen met elektromechanische/elektronische delen welke aangestuurd worden door een controle unit, controleert dit apparaat of:

- controle unit voorzien is van voeding en de controle functie werkt
- kabel aansluiting tussen het onderdeel en controle unit efficiënt is.
- het geteste onderdeel niet is aangesloten
- het onderdeel geen kortsluiting heeft gehad
- het onderdeel elektronisch funtioneert

1760/RSE € 495,00 1 017600170



1760/TC2

Combinatie contact / geen-contact digitale tachometer



Technische Informatie

- Voor meten:
 - geen-contact rotatiesnelheid (t/min - RPM)
 - contact rotatie (t/min - RPM) en lineaire oppervlaktesnelheid (m/min of voet/min; ft/min).
- 5-cijferig LCD display.
- Schaal:
 - geen-contact snelheid 2.5÷99,999 rpm - t/min
 - contact snelheid 0.5÷19,999 rpm - t/min
 - lineaire oppervlaktesnelheid 0.05÷1,999.9 m/min.
- Frequentie: 0.8 sec.
- Voeding: 4 1.5V batterijen, AA maat of 6V voedingsunit (niet inbegrepen).
- Geleverd met het volgende:
 - adapter voor contact tip meting;
 - mannelijke (contact) rubberen tip (2 stuks);
 - vrouwelijk (contact) rubberen tip (1 stuk);
 - lineair meetlint (1 stuk);
 - reflecterend lint;
 - handleiding;
 - kunststof kist.

	L	H	€		
1760/TC2	230 mm	74 mm	255,00	1	017600161

1760R/TC2

Set van reflecterende band voor item 1760/TC2



1760R/TC2	€		
	24,20	1	017600561

1760K

non-contact AC volt detector met LED mini-spotlight

Meetbereik: 200-1000Vac 50/60Hz
CAT III-1000V
Voeding 2 AAA batterijen (meegeleverd)



1760K	€		
	43,00	1	017600140

1760PT

Gecombineerde volt en continuïteit tester, 12-690V AC/DC

- Test functies:
- continuïteit
 - phase rotatie
 - netspanning testen
 - LED spotlight



1760PT	€		
	184,50	1	017600150

1760/IR500

digitale infrarood thermometer met dubbele laser geleiding systeem

niet geschikt voor het meten van lichaamstemperatuur



TECHNISCHE DATA
Temperatuur bereik: -50 + 500 °C (-22 + 932 °F)
Beeld resolutie: 0.1 °C (0,1 °F)
Emissiviteit: 0.1 ÷ 1 instelbaar
Nauwkeurigheid: -50 °C + 20 °C (+/- 3 °C); 20 + 500 °C (+/-2% or 2 °C)
Optische resolutie (D:S): 12:1
Automatische uitschakeling: ca. 10 seconden
Werktemperatuur: 0 °C + 50 °C
Opberg temperatuur: -20 °C + 60 °C
Voeding: 1 9V batterij

1760/IR500	€		
	175,00	1	017600350

1760/IR1000

Digitale infrarood thermometer met dubbele laser geleiding systeem

niet geschikt voor het meten van lichaamstemperatuur



TECHNISCHE DATA
Temperatuur bereik: -50 °C + 1000 °C (-58 °F + 1832 °F)
Beeld resolutie: 0.1 °C (0.1 °F)
Emissiviteit: 0.1 ÷ 1 instelbaar
Nauwkeurigheid: -50 °C + 20 °C (+/- 3.5 °C); 20 °C + 300 °C (+/-1% or 1 °C); 300 °C + 1000 °C (+/-1.5%)
Optische resolutie (D:S): 20:1
Werktemperatuur: 0 °C + 50 °C
Opberg temperatuur: -10 °C + 60 °C
Voeding: 2 1.5V (AAA type batterijen)

1760/IR1000	€		
	290,00	1	017600400

1760/IR1600

Digitale infrarode thermometer met laser geleiding systeem

niet geschikt voor het meten van lichaamstemperatuur



TECHNISCHE DATA
Bereik: van -50 °C tot +1600 °C / -58 °F tot +2912 °F
Weergave selectie: °C/°F
Nauwkeurigheid: ±1.5% or ±2 °C to 20 °C
Laser sterkte: <1mW
Reactietijd: 1sec
Uitstralingsgraad: 0.10-1.0 instelbaar
Afstand ratio: (D:S) 50:1
Werktemperatuur: 0 °C + 50 °C / 32 °F + 122 °F
Omgevings luchtvochtigheid: 10% to 90% RH
Verlicht LCD venster
Data geheugen functie
Automatisch uitschakelfunctie
Voeding: 1 9V batterij (meegeleverd)
Harde koffer met aluminium driepoot
Gebruiksaanwijzing

1760/IR1600	mm	mm	€		
	200	115	795,00	1	017600461



1760LX

draagbare digitale luxmeter

EN61010-1
EN61326-1

CE



Technische details:
Meetbereik Basisnauwkeurigheid
Lux-meetbereik: 0-200000 ±3%
FC-meetbereik: 0-20000 ±3%
Voeding: 1x 9V

1760LX	L mm	€	1	017600820
	165	115,50		

1760TMC

Infrarode warmtebeeld camera

Compact warmtebeeld camera voor het contactloos temperatuur meten, geschikt voor toepassing in de bouw, mechanische, elektrische installatie en verwarmingsindustrie

LCD TFT scherm, 2", 240x320
sensor, 32x32 pixels
Beeldfrequentie 7Hz
Thermische gevoeligheid <347mK
Automatische weergave van warme en koude plekken
Camera voor weergave van afbeeldingen in BMP-formaat (max. 100 afbeeldingen)
Instelbare emissiviteit
Voeding: 3 alkaline AAA-batterijen
USB-interface
IP54
Temperatuurbereik: -20 °C ÷ +600 °C
Spectraal bereik: 6,5 ÷ 14 μm
Zichtbare / infraroodbeeldfusie: 0,5; 1; 2m
Alarmfunctie, het selecteren van aanvaardbare maximum- en minimumtemperaturen

CE



1760TMC 600	€	1	017600710
	958,00		

1760WM

digitale windmeter met ventilatorsensor

EN61010-1
EN61326-1

CE



Technische details:
Meetbereik Basisnauwkeurigheid
m/s luchtsnelheidsbereik: 0,4-30 ±2%
k/n luchtsnelheidsbereik: 1,4-108 ±2%
ft/m luchtsnelheidsbereik: 80-5900 ±2%
mil/h luchtsnelheidsbereik: 0,8-58 ±2%
CFM-luchtstroombereik: 0-99990 ±0-9,999 ft2
CMM luchtstroombereik: 0-99990 ±0-9,999 m2
CMS luchtstroombereik: 0-99990 ±0-9,999 m2

1760WM	L mm	€	1	017600800
	170	93,50		

1761

Borgdraadtang met automatische terugstelling



L mm	€	1	017610101
255	74,50		

1761RS/1

Borgdraadtang, links en rechtsdraaiend met automatische terugstelling



L mm	€	1	017610130
220	133,50		

1762

Revolver holpijptang



Ø mm	L mm	€	2	017620001
2-2,5-3	210	34,50		
3,5-4-4,5				

1763

Tang voor bekledingskrammen



1763	€	1	017630001
	43,00		

1763G/S500

500 autobekleding krammen



1763G/S500	€	1	017630105
	83,00		

1764/K5

Blindklinktang voor plastic klinknagels

Geleverd met klinknagels in 4 maten

INHOUD:

- 10 klinknagels Ø 5x17.2 mm
- 10 klinknagels Ø 5x15.8 mm
- 10 klinknagels Ø 6.3x25.2 mm
- 10 klinknagels Ø 6.6x17.2 mm



1764/K5	€	1	017640001
	59,00		

1764/K5-R

Set van 20 plastic klinknagels voor artikel 1764/K5



1764/K5-R1	5X17,2	€	1	017640003
1764/K5-R2	5X15,8	15,00	1	017640004
1764/K5-R3	6,3X25,2	15,00	1	017640005
1764/K5-R4	6,6X17,2	15,00	1	017640006

1765/C24

24-del set demontage trekkers voor autoradio in kist



1765/C24 € 222,50 1 017650001

1766

Dubbele zuignap



max kg 50 € 144,00 2 017660001

1766A

Enkelvoudige zuignap



max kg 30 € 34,50 2 017660005

1766/8

8-delig assortiment voor bewerking aan de autoruit



1766/8 € 537,00 1 017660100

1766ER

Zijruitrubber trekker met handgreep

Maakt het mogelijk de zijruitrubbers eenvoudig te verwijderen, zonder het risico op beschadigingen



1766ER € 24,70 1 017660501

1766ER/VW

Raamrubber verwijderaar met een laag profiel

Bijzonder geschikt voor ruiten van voertuigen van de VAG groep met beperkte grip ruimte

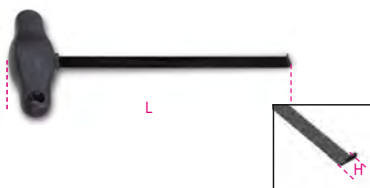

L mm 215 H mm 4 € 17,60 1 017660510

1766L

Hefboom voor ruiten



1766L € 60,50 1 017660015

1766LI

Hefboom voor het plaatsen van trekdraad bij autoruiten

Scherpe kanten voor het snijden van kit



1766LI € 21,10 1 017660016

1766I

T handgrepen voor het trekken van stalen draad 1766G

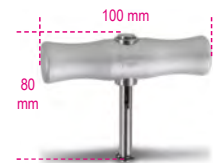

1766I € 59,50 2 017660020

1766G

Stalen snijdraad voor autoruiten

Vierkant deel



50 m € 50,00 1 017660025

1766T

Stalen snijdraad voor autoruiten

Driehoekige vorm



50 m € 57,50 1 017660026



1767A

Telescopische steun

- Ontworpen om motorkleppen en kofferbakdeksel te ondersteunen bij het ontbreken van de gasveren.
- Kan gebruikt worden om pedalen te fixeren.



L mm
640 ÷ 1090

€ 74,50

1 017670000

1767B

Pedaal en stuur blokkeer set

Het afstellen via het trekmechanisme garandeert nauwkeurige instelling terwijl de motor draaiend wordt gehouden



1767B

€ 154,00

1 017670100

490x285x95 mm - 2,4 kg

1767PMC

Magnetische gereedschaphouder, rond



1767PMC

€ 25,00

1 017670020

1767PMR

Magnetische gereedschaphouder, rechthoekig

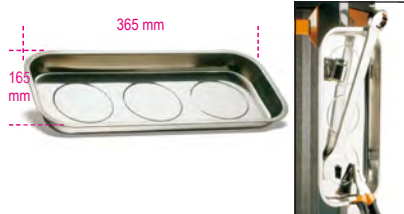

1767PMR

€ 53,00

1 017670010

1768

Aluminium opstap

Voorzien van anti-slip materiaal
Maximale belastbaarheid: 200 kg



L mm 960

L1 mm 300

H mm 475

€ 215,50

1 017680010

1770

Afbreekmes, plat model, geleverd met twee extra messen



1770

L mm 140

A mm 9

€ 20,70

10 017700001

1770A

9 mm afbreekmes met automatisch blokkeersysteem, 3 reserve messen



1770A

L mm 135

A mm 9

€ 7,65

10 017700025

1770RL

Reserve afbreekmessen, verpakt per 10 stuks, voor model 1770, 1770BM en 1770A



1770RL

€ 6,50

5 017700010

1770BM

Afbreekmes, 9 mm, 6 extra messen



1770BM

L mm 140

A mm 9

€ 16,20

10 017700050

1771

Afbreekmes, 18 mm. Geleverd met 3 reserve messen



1771

€ 11,80

10 017710000

1771BM

Afbreekmes met 5 reserve bladen



1771BM

L mm 170

A mm 18

€ 26,50

10 017710050

1771HD

Afbreekmes, 18 mm, Geleverd met 6 reserve bladen

- Automatisch messen verwisselen
- Mes blokkeer mechanisme



1771HD

L mm 190

A mm 18

€ 29,50

5 017710100

1771RL

Reserve afbreekmessen 18 mm, verpakt per 10 stuks, voor model 1771, 1771BM, 1771HD



1771RL

€ 9,60

5 017710010

1772M

Veiligheidsmes met inschuifbaar snijmes, geleverd met 3 extra snijmessen

- Snijmes intrekbaar door een automatisch veermechanisme
- Handgreep vervaardigd uit giet legering
- Kram verwijderaar in de handgreep



1772M

L mm 170

A mm 18

€ 23,50

5 017720040

1772R

Universeel mes met uitschuifbaar lemmet, geleverd met 5 extra messen



	L mm	A mm	€		
1772R	125	18	22,40	5	017720006

1772H

Universeel mes met uitschuifbaar lemmet, geleverd met extra messen



	L mm	A mm	€		
1772H	170	18	23,70	5	017720029

1772RL/2

Reserve messen per 10 verpakt voor de modellen 1772H, 1772M, 1772R, 1774, 1777BMT, 1777T

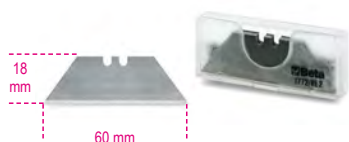

	€		
1772RL/2	5,65	5	017720017

1773A

Afbreekmes 25 mm



	L mm	A mm	€		
1773A	180	25	23,00	10	017730000

1773RL

Reserve afbreekmessen 25 mm, verpakt per 10 stuks voor model 1773A



	€		
1773RL	22,70	5	017730015

1773S

Veiligheidsmes met rond blad

- mes Ø 28 mm
- secundair mes voor het snijden van folie
- ophanghaak



	L mm	A mm	€		
1773S	190	28	15,00	1	017730100

1773S/RL



	€		
1773S/RL	7,50	5	017730110

1774

Universeel schraapmes met mesbeschermer



	L mm	L1 mm	€		
1774	155	60	5,00	5	017740001

1774A

Multifunctionele schrapper, twee componenten handgreep



	L mm	A mm	€		
1774A	300	40	16,90	1	017740011

1774A/RL

10 messen voor de schrapers 1774A en 1774S

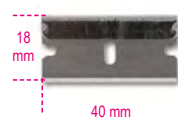

	€		
1774A/RL	6,95	1	017740511

1774S

Stickerschraper



	A mm	L mm	€		
1774S	40	100	7,90	2	017740021

1777BM

Klapmes met inkeping voor draadstrippen, roestvast stalen lemmet



	L mm	L1 mm	A mm	€		
1777BM	190	80	16	15,30	5	017770100

1777T

Klapmes met verwisselbare messen, 5 reserve messen



	L mm	A mm	L1 mm	€		
1777T	160	19	65	32,00	5	017770030

1777BMT

Klapmes met verwisselbare messen
4 instelbare snijdieptes
4; 9.5; 15.5; 21.5 mm
geleverd met 3 reserve messen



	L mm	L1 mm	A mm	€		
1777BMT	170	80	19	35,00	5	017770050

1778AN

inlapbaar mes, roestvaststaal blad, lichtgewicht geanodiseerd aluminium handvat
• in houder



	L mm	A mm	L1 mm	€		
1778AN	204	26	84	41,50	5	017780065

1778AX

Klapmes,
roestvaststalen getand lemmet,
aluminium handgreep,
tandpatroon voor het gemakkelijker openen
• In etui



	L	A	L1	€		
	mm	mm	mm			
1778AX	189	26	80	50,50	5	017780026

1778BS

opvouwbaar mes
met dubbel veiligheidsslot,
roestvrij staal gekarteld blad,
afwerking in carbonlook

in etui



	L	A	L1	€		
	mm	mm	mm			
1778BS	200	29	85	49,00	10	017780035

1778CM

Klapmes, gehard stalen lemmet,
camouflage print.
In etui



	L	A	L1	€		
	mm	mm	mm			
1778CM	195	24	80	41,00	5	017780099

1778M7

inklapbaar mes,
roestvaststaal miniblad,
handvat met glasvezel inzetstukken
• in houder



	L	A	L1	€		
	mm	mm	mm			
1778M7	163	24	68	36,50	5	017780015

1778P

Klapmes,
roestvast staal lemmet en aluminium
handgreep,
door drukknop eenvoudig het mes uit te
klappen
• In etui



	L	A	L1	€		
	mm	mm	mm			
1778P	193	29	72	48,00	5	017780088

1778SCL

Klapmes met zacht carbonachtige afwerking,
gehard stalen lemmet.
In etui



	L	A	L1	€		
	mm	mm	mm			
1778SCL	180	22	78	38,50	5	017780089

1778SOS

Klapmes,
met ramenbreker en gordelsnijder.
In etui.



	L	A	L1	€		
	mm	mm	mm			
1778SOS	205	25	85	41,50	5	017780080

1778V18

Klapmes,
aluminium handgreep
• in houder



	L	A	L1	€		
	mm	mm	mm			
1778V18	195	25	85	38,50	5	017780018

1778X

Mes voor nautische werkzaamheden,
roestvast stalen lemmet in etui.



	L	L1	A	€		
	mm	mm	mm			
1778X	185	85	25	41,00	2	017780050



Beta

1778MT - MULTITOOL

BETA's multifunctionele gereedschap onderscheidt zich van de in de handel verkrijgbare en vergelijkbare gereedschappen met de typische kenmerken van BETA: tangen die synoniem staan voor ongeëvenaarde kwaliteit, geavanceerde materialen en state-of-the-art technologie. De **11 bits**, die in de meest voorkomende vormen op de markt worden geleverd, maken dit item ideaal voor alle werkomgevingen en omstandigheden, b.v. kamperen, nautische industrie, jacht en doe-het-zelf.



22 FUNCTIES

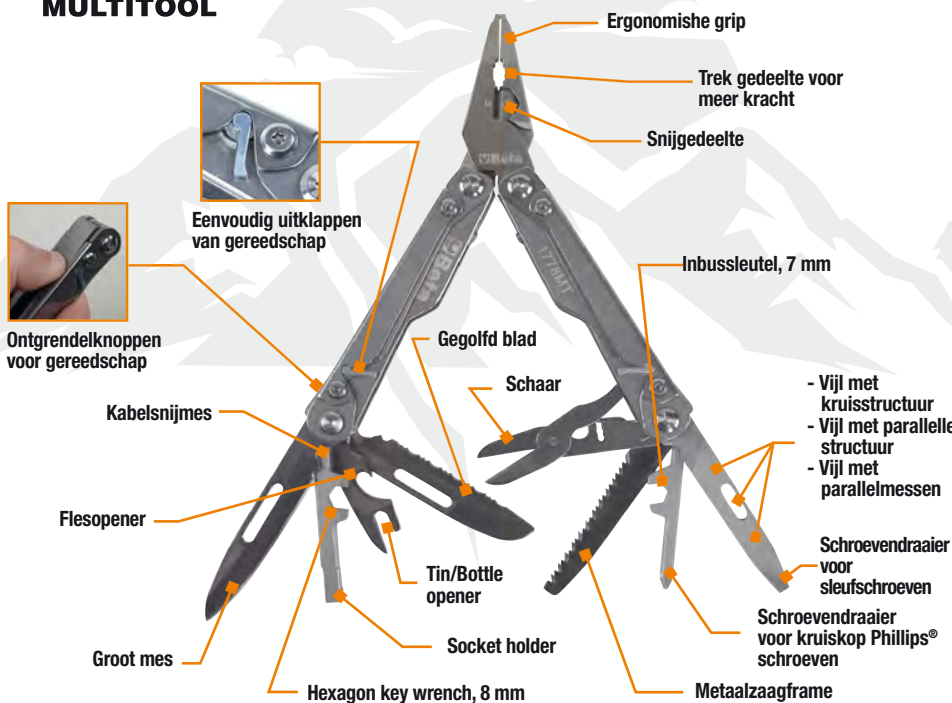

11 bits



Liniaal 100 mm / 4"

1778MT

multitools Zakmes compleet met bits en opberghoesje 9 delig, 22 functies



L mm	L1 mm	€	Uitval	Art. No.
180	115	125,00	1	017780055

1781

Handwerkschaar lange spitse bladen



Art. No.	L mm	€	Uitval	Art. No.
1781	132	20,90	2	017810001

1783

Scharen voor licht gebruik



Art. No.	L mm	€	Uitval	Art. No.
	215	18,40	5	017830021
	240	20,30	5	017830024

1784

Kleermakersscharen



Art. No.	L mm	€	Uitval	Art. No.
	175	27,50	2	017840017
	200	35,50	2	017840020
	250	47,00	2	017840025
	300	62,50	2	017840030

1800/100

Opblaasbare wiggen (max. lift capaciteit: 100 kg)

- liften/afstellen
- fixeren van deuren



Art. No.	A mm	B mm	S mm	€	Uitval	Art. No.
	160	150	2+55	63,00	3	018000000



Beta

VERLICHTING

Het verlichting assortiment omvat een breed scala aan producten die zijn ontworpen om aan alle eisen van gebruikers te voldoen, gaande van het inspecteren van kleine buizen tot het verlichten van grote werkgebieden.

ZAKLAMPEN

Door het nieuwe boeiende ontwerp, de technische verbeteringen en de grote keuze aan formaten kan de meest geschikte zaklamp worden geselecteerd op basis van criteria als helderheid, batterijduur en prestatie.

LAMPEN EN SCHIJNWERPERS

Op basis van verbeterde LED-technologie, langere batterijduur, kortere oplaadtijd, nauwgezette aandacht voor materialen en voortdurende zoektocht naar innovatieve oplossingen, betekenen Beta's werklampen een uitstekende combinatie van design, functionaliteit en prestatie.

Een uitgebreid assortiment dat is ontworpen om professionals in staat te stellen op hun best te werken, in elke sector en onder alle omstandigheden.



DRAADLOOS

Dankzij nieuwe draadloze technologie kunnen de nieuwste schijnwerpers en lampen worden opgeladen via één oplaadstation, artikel 1839BRW.

Het nieuwe oplaadstation, 1839BRW, maakt het mogelijk om tegelijkertijd de nieuwste schijnwerpers en lampen op te laden. Kan gebruikt worden zonder oplaadsnoertjes. Bovendien maakt de uittrekbare ondersteuning het draadloos opladen van mobiele telefoons mogelijk.



CRI - Color Rendering Index

CCT - Correlated Color Temperature

LAMPEN

ITEM	LUMEN	BATTERIJ	OPLAAD TIJD	LEVENSDUUR	IP/IK	CCT	CRI
1837C/2100	500 - 1000 - 2100	Li-Ion 11.1V; 4400 mAh	4.0h	9 - 2.5h	IP65 - IK07	6500K	80+
1837C/4300	1100 - 2100 - 4300	Li-Ion 11.1V; 5200 mAh	4.0h	6 - 1.5h	IP65 - IK07	6500K	80+
1837M	500 - 1000 - 2000	Li-Ion 11.1 V; 5200 mAh	3.5h	2 - 8h	IP65 - IK07	2700-3500-4500-5500-6500K	96+
1838FLASH	360 - 720	Li-Ion 7.4 V; 4000 mAh	4.0h	4 - 8h	IP65	6300K	-
1838POCKET	160 - 400 - 800	Li-Ion 3.7 V; 2600 mAh	4.0h	3 - 9h	IP65	6500K	80+

LAMPEN

ITEM	LUMEN	BATTERIJ	OPLAAD TIJD	LEVENSDUUR	IP/IK	CCT	CRI
1838/11LED	320	Li-Ion 3.7V; 4200 mAh	4.0h	4h	IP65	6500K	
1838AM	60 - 700 120 (spot)	Li-Ion 3.7V; 2600 mAh	4.0h - USB-C	2.5 - 16h 10h (spot)	IP54 - IK07	6500K	80+ 70+
1838COB	100 - 200 75 (spot)	Li-Ion 3.7V; 1600 mAh	3.0h	3-6h 4h (spot)	IP65	6000K	80+
1838P	80 - 50	Li-Ion 3.7V; 700 mAh	2.5h	4h	IP20	6000K	80+
1838SLIM	100 - 200 180 (back) 80 (spot)	Li-Ion 3.7 V; 700 mAh	2.5h - USB-C	2 - 4h 2h (back) 3h (spot)	IP54 - IK07	6500K	80
1838UV	75 - 150	Li-Ion 3.7V; 1600 mAh	3.0h	3h	IP20	6000K	80
1838SW	250 - 500 - 1000	Li-Ion 3.6V; 3350 mAh	4.5 - 6.5h	3 - 7h	IP65 - IK07	6500K	80+
1838E	500 - 1000 - 2000	Li-Ion 3.6V; 3350 mAh	4.5 - 6.5h	3 - 9h	IP20 - IK07	5500K	80+

HOOFDLAMPEN

ITEM	LUMEN	BATTERIJ	OPLAAD TIJD	LEVENSDUUR	IP/IK	CCT	CRI
1836B	125 - 250	Li-Ion 3.8V; 1600 mAh	3.0h	5h	IP65 - IK07	6000K	80+
1836AW	30 - 200 - 400	Li-Ion 3.7V; 1500 mAh	2.5h	4-18h	IP65 - IK07	6500K	80+

ZAKLAMPEN

ITEM	LUMEN	BATTERIJ	OPLAAD TIJD	LEVENSDUUR	IP/IK	VERLICHTINGSBEREIK
1833XS/1	100	1 x AAA	-	5h	IP66	85m
1833XS/2	200	2 x AAA	-	10h	IP66	112m
1833S	500	2 x AA	-	10h	IP66	140m
1833M	700	3 x AAA	-	7.5h	IP66	170m
1833L	1100	3 x AA	-	8.5h	IP66	330m
1833L/USB	1200	Li-Ion 3.7 V; 2600 mAh	3.0h - USB-C	3.0h	IP66	230m
1833XSW	80 - 250	Li-Ion 3.7V 2600 mAh	2.0 h	2.0-8.0h	IP54 - IK07	
1833MW	5 - 30 - 400 - 1000	Li-Ion 3.7V; 2600 mAh	4.0 - 6.0 h	2.0-200.0h	IP68 - IK07	
1833XL	1500	3xD	-	22h	IP66	290m
1837F	500	3 x AA	-	14.5h	IP66	125m
1837F/USB	600	Li-Ion 3.7 V; 2900 mAh	4.0h - USB-C	10h	IP66	280m

1833L/USB

Ultra heldere LED zaklamp, gemaakt van stevig geanodiseerd aluminium, tot 1.200 lumen

- instelbare focus
- 3 helderheids standen
- batterijduur: 3.0h
- IP66
- verlichtingsbereik: 230 m
- platte batterij-indicator (<15%)
- opladen via USB-C-poort
- oplader niet inbegrepen



L mm 240 € 128,50 1 018330054

1833RB-L/USB

Reserve batterij voor artikel 1833L/USB

1833RB-L/USB € 60,50 1 018330975

1833XS/1

LED-inspectiezaklamp, gemaakt van stevig geanodiseerd aluminium

- 100 lumen
- instelbare focus
- batterij: 1xAAA (niet inbegrepen)
- IP66
- batterijduur: 5.0h
- verlichtingsbereik: 85 m



L mm 92 € 22,40 3 018330000

1833XS/2

LED-inspectiezaklamp, gemaakt van stevig geanodiseerd aluminium

- 200 lumen
- instelbare focus
- batterijen: 2xAAA (niet inbegrepen)
- IP66
- batterijduur: 10,0 uur
- verlichtingsbereik: 112 m



L mm 133 € 24,50 3 018330001

1833XSW

LED-inspectiezaklamp, draadloos oplaadbaar

- Twee helderheidsinstellingen: LED SMD, 250 - 80 Lumen
- Oplaadbare batterij: 3,7 V 700 mAh, 2,59 Wh Li-ion
- Twee oplaadmodi: draadloze basis 1839BRW voeding met USB-C-poort
- Laadtijd: 2 uur met draadloos oplaadstation
- 2 uur met stroomvoorziening
- Levensduur batterij: 2-8 uur
- LED-indicator voor batterijniveau
- Magneten op basis en achterkant
- Riem clip
- IP54
- IK07
- USB-C-kabel meegeleverd



L mm 145 € 49,00 1 018330011

1833S

Ultra heldere LED zaklamp, gemaakt van stevig geanodiseerd aluminium, tot 500 lumen

- instelbare focus
- 2 helderheids standen
- batterijen: 2xAA (niet inbegrepen)
- batterijduur: 10,0 uur
- IP66
- verlichtingsbereik: 140 m



L mm 150 € 43,00 1 018330002

1833M

Ultra heldere LED zaklamp, gemaakt van stevig geanodiseerd aluminium, tot 700 lumen"

- instelbare focus
- 2 helderheids standen
- batterijen: 3xAAA (niet inbegrepen)
- lege batterij-indicator (<15%)
- batterijduur: 7,5 uur
- IP66
- verlichtingsbereik: 170 m



L mm 162 € 59,00 1 018330003

1833MW

LED-zaklamp met hoge helderheid, draadloos oplaadbaar

- Vier helderheidsinstellingen: LED SMD, 1000 - 400 - 30 - 5 Lumen
- Oplaadbare batterij: 3,7 V 2600 mAh, 9,62 Wh Li-ion
- Twee oplaadmodi: draadloze basis 1839BRE voeding met USB-C-poort
- Laadtijd: 6 uur met draadloos oplaadstation
- 4 uur met stroomvoorziening
- Levensduur batterij: 2-200 uur
- Batterijniveau-indicator met 3 LED's
- Magneet op de achterkant
- IP68
- IK07
- USB-C-kabel meegeleverd



L mm 160 € 85,00 1 018330013

1833L

Ultra heldere LED zaklamp, gemaakt van stevig geanodiseerd aluminium, tot 1.100 lumen

- instelbare focus
- 2 helderheids standen
- batterijen: 3xD (niet inbegrepen)
- lege batterij-indicator (<15%)
- batterijduur: 22,0 uur
- IP66
- verlichtingsbereik: 330m



L mm 196 € 88,00 1 018330004

1833XL

Ultra heldere LED zaklamp, gemaakt van stevig geanodiseerd aluminium, tot 1.500 lumen

- instelbare focus
- 2 helderheids standen
- batterijen: 3xD (niet inbegrepen)
- lege batterij-indicator (<15%)
- batterijduur: 22,0 uur
- IP66
- verlichtingsbereik: 290 m



L mm 300 € 110,00 1 018330005

1836AW

oplaadbare draadloze LED-koplamp, dubbele helderheid

- dubbele lichtemissie: voorzijde: 3 lichtsterktes, LED COB, 30 - 200 - 400 lumen hoofd (spot): LED COB, 400 lumen
- oplaadbare batterij: Li-Ion 3,7 V, 1500 mAh, 5,55 Wh
- USB-C-poort
- geleverd met USB-C-kabel
- oplaadtijd: 2,5 h
- batterijduur: voor: 4-18 uur hoofd (schijnwerper): 4 h
- IP65
- IK 07



1836AW € 79,50 1 018360051

1836B

oplaadbare LED-koplamp, dubbele helderheid, met AAN/UIT-sensor

- contactloze AAN/UIT-sensor
- compleet met USB-oplaadkabel / mini-jack + oplader
- 250 lumen
- levensduur batterij: 3-6 uur
- IP65



1836B € 146,50 1 018360200

1837F

Magnetische flexibele werkklamp met ultra heldere LEDs, vervaardigd uit stevig geanodiseerd aluminium, Lichtsterkte tot 500 lumen

- Instelbare focus
- 2 lichtsterktes
- Batterijen: 3xAA (niet meegeleverd)
- Batterij levensduur: 14,5 uur
- Lege batterij indicator
- IP66



L mm 460 € 93,50 1 018370050

1837F/USB

oplaadbare magnetische lamp met LED's met hoge helderheid, gemaakt van stevig geanodiseerd aluminium, tot 600 lumen

- instelbare scherpstelling
- 2 helderheidsinstellingen
- levensduur batterij: 10,0 uur
- lege batterij-indicator <15%
- opladen met USB-C-poort
- compleet met USB-C-kabel
- IP66



L mm	€	1	018370060
460	138,00		

1837RB-F/USB

Reserve batterij voor artikel 1837F/USB

1837RB-F/USB	€	1	018370960
	46,00		

1838POCKET

Verstelbare LED werklamp, met dubbele lichtbundel, draadloos oplaadbaar

- dubbele lichtemissie: hoofdlucht: LED COB, 3 lichtsterktes: 160 - 400 - 800 lumen spotlicht: LED SMD, 250 lumen
- verlichtingshoek: hoofdlucht: 160° spotlicht: 18°
- oplaadbaar lampje 3,7V 2600mAh Li-ion
- 2 oplaadmodi: draadloze basis 1839BRW (los leverbaar) voeding met USB-C-poort
- laadtijd: 4,5 uur met draadloos oplaadstation 4 uur met stroomvoorziening
- batterijduur: hoofdlucht: 3-9 uur spotlicht: 4,5 uur
- Batterijniveau-indicator met 3 LED's
- kan 210° worden gedraaid
- antislip rubberen behuizing
- magnetische basis
- 1 magneet op basis
- IP65
- IK07
- compleet met USB-C-kabel



L mm	I mm	S mm	€	1	018380080
98	82	39	74,00		

1837C

Oplaadbare LED schijnwerper voor bouwplaatsen

- 3 helderheidsinstellingen
- Batterij lader: voeding: 100-240V AC - 50/60Hz; laden: 15V 1.5A
- Laadtijd: 4 hours
- 3-LED laad indicatie
- Draaibaar tot 180°
- IP65
- IK07



LxHxI mm	Lm	h	€	1	018370210
220x225x70	2100	2.5	198,50		
	1000	5.0			
	500	9.0			
266x236.6x59	4300	1.5	294,00		1 018370430
	2100	3.0			
	1100	6.0			

1837C/RA2100-4300

Voeding voor LED-lampen 1837C/2100-4300

1837C/RA2100-4300	€	1	018370970
	28,50		

1837M

Oplaadbare LED COLOUR MATCH schijnwerper, voor visuele kleur controle, hoge kleur wergave index (CRI 96+), tot 2,000 lumen

- 3 helderheidsinstellingen: 500 / 1.000 / 2.000 lumen
- CRI (kleurweergave-index): 96+
- CCT (gecorrleerde kleurtemperatuur): 2700K / 3500K / 4500K / 5500K / 6500K
- Batterijlader: ingang: 100-240V AC - 50 / 60Hz; uitgang: 15V 1.5A
- Laadconnector met snelsluiting
- Oplaadtijd: 3,5 uur
- Brandtijd: 8/4/2 u
- Oplaadindicator
- Knop en LED-kleurtemperatuurindicator
- knop en LED-helderheidsindicator
- Is 180° draaibaar
- IP65



LxHxI mm	Lm	h	€	1	018370450
220x225x70	500	8.0	317,00		
	1000	4.0			
	2000	2.0			

1837M/RA

Stroomvoorziening voor COLOUR MATCH lampen 1837M



1837M/RA	€	1	018370975
	54,50		

1837S

Telescopische driepoot statief voor werklamp

- Vervaardigd uit metaal
- Instelbare hoogte: 70÷155 cm
- Geschikt voor lampen 1837C en 1838FLASH



h cm	€	1	018370500
70÷170	63,50		

1838FLASH

Oplaadbare ultracompacte schijnwerper, ontworpen om een zo goed mogelijk licht oplossing te bieden

- BESCHIKBAAR VOLLEDIGE VERLICHTING: met een maximale verlichting van 720 lumen, verkrijgbaar uit zowel de batterij of met aangesloten kabel is de lamp altijd gebruiksklaar.
- IS OVERAL TE PLAATSEN: -op vlakke ondergrond: met rubber poten op drie punten of op een 1/4" vierkant voor standards (zoals een camera standaard)
- op metalen constructies: met een vaste magneet of haak welke 360 graden kan draaien.
- COMPACT: niet meer dan 85x100x155 mm in afmeting, kan het eenvoudig meegenomen worden in een gereedschapstas en is te gebruiken in kleine ruimten.
- ROBUUST: ontworpen om weerstand te bieden tegen extreem zware mechanische stress. Gegarandeerd duurzaam.



1838FLASH	€	1	018380300
	367,00		

1838RB/FLASH

Reserve batterij voor artikel 1838/FLASH

1838RB/FLASH	€	1	018380930
	85,50		

1838/11LED

Oplaadbare inspectielamp met ultra heldere LEDs,
lithium polymeer batterij

- Compacte behuizing uit anti-slip rubber
- Eenvoudige te vervangen beschermglas
- Draaibare ophanghaak • Met laadstation, 110-230Vac
- 320 lumen
- Met dubbele LED lichtbundel



1838/11LED € 178,00 1 018380111

1838RA/10-11LED

Oplader voor artikelen 1838/10LED en 1838/11LED

CE

1838RA/10-11LED € 37,00 1 018380903

1838RB/10LED

Reserve accupack voor artikelen 1838/10LED en 1838/11LED

1838RB/10LED € 61,00 1 018380902

1838RR/11LED

Laadstation voor artikel 1838/11LED

1838RR/11LED € 40,00 1 018380914

1838RV/11LED

Reserve krasbestendig beschermglas voor lamp 1838/11LED



1838RV/11LED € 6,10 2 018380905



1838AM

oplaadbare LED-inspectielamp, met dubbele lichtbundel, scharnierend, 180° draaibaar, met draaibare magneetvoet en haak

- dubbele licht emissie: voorzijde: LED COB, 60-700 lumen, instelbaar met potmeter spot (kop): LED SMD, 120 lumen, AAN-UIT-schakelaar
- oplaadbare 3.6V 2600mAh Li-ion batterij
- met USB-C-poort
- geleverd met 100-240V / 50-60Hz oplader
- oplaadtijd: 4u
- batterijduur: voor: 2,5-16 uur plek (hoofd): 10h
- 3-LED batterijniveau-indicator

- scharnierend, 180° draaibaar (± 90° tov as)
- magnetische voet (met neodmium magneet), 90° draaibaar
- draaibare basishaak

- IP54
- IK07



L I S L1
mm mm mm mm mm
1838AM 405 40 45 175 € 131,50 1 018380400

1838COB

Oplaadbare LED inspectie lamp

- Met ophanghaak en antislip schokbestendige behuizing
- Lithium polymeer batterij
- Magnetische voet welke 180 graden draaibaar is
- Met lader 100-240Vac / 50-60Hz
- 100/200 lumen; LICHTSPOT 75 lumen
- Branduren: 6 uur / 3 uur; SPOT 4 uur
- Laadtijd: 3 hours
- IP65

CE
IP65



1838COB € 100,50 1 018380010

1838P

Oplaadbare inspectie lampje, met dubbele lichtstraal: lamp en spot

- Compact behuizing vervaardigd uit anti-slip rubber
- 75/150 lumen
- Zakclip
- Magnetische voet kan 180 graden gedraaid worden
- Compleet met USB plug laadkabel, 3.5mm
- Brandtijd: 2.5 uur
- IP65



1838P € 88,00 1 018380005

1838SLIM

oplaadbare slanke inspectielamp met 3 LED's

- drievoudige lichtemissie
- voorkant: 100/200 lumen/ achterkant: 180 lumen/ spot (kop): 80 lumen
- magnetische basis
- oplaadtijd: 2,5 uur
- levensduur batterij: 2-4 uur/spot 3 uur
- compleet met USB-C-kabel

CE
IP54



L I S
mm mm mm mm
1838SLIM 307 17 29 € 79,00 1 018380221



1838SW

Oplaadbare scharnier LED-inspectielamp , met draadloze oplader

- Dubbele lichtbron:
- Voor kant: LED COB, 3 lichtintensiteiten: 250 - 500 - 1000 lumen
- Spot (hoofd): LED SMD, 200 Lumens
- Oplaadbare 3.6V 3.350 MAH Li-ion batterij
- 2 laadmodi: draadloos 1839BRW-basis
- Voeding met USB-C-poort
- Oplaadtijd: 6.5h met draadloze oplaadbasis
- 4.5h met voeding
- Levensduur van de batterij: Voor kant: 3-5h
- Spot (hoofd): 7h
- 3-led batterijniveau-indicator
- Basis kan 180 ° worden geroteerd
- Anti-slip rubberen body
- Dubbele draaibare haak
- 3 magneten op de achterkant
- 1 magneet op basis
- IP65
- IK07
- Geleverd met een USB-C-kabel



L	I	S	€	1	018380142
260 mm	53 mm	40 mm	105,50		

1838UV

Oplaadbare inspectie lamp met UV en wit licht ideaal voor het dedecteren van lekken

- Compacte behuizing vervaardigd uit antislip rubber
- Met lader 100-240Vac / 50-60Hz
- 150 lumen / UV



L	I	S	€	1	018380150
171,50			171,50		

1838E

Oplaadbare motorkap LED lamp

- Drievoudige lichtafgifte: 500/1000/2000 lumen
- Is 360° draaibaar
- Lengte instelling: 116 ± 188 cm
- Aluminium behuizing
- Anti slip rubber haken
- USB-C laad aansluiting
- 2 laad mogelijkheden:
- laden via de lamp door USB port
- laden direct van de batterij door USB port
- Geleverd met batterij lader
- voeding: 100-240V ~ 50/60Hz
- uitgang: DC 5V - 2000 mA
- Branduren: 3-9 h
- IP20
- IK07



IP20
IK07

L min	L max	I	€	1	018380270
1170 mm	1880 mm	150 mm	200,50		

1838E-BT

Oplaadbare batterij met USB-C aansluiting voor motorkap lamp artikel 1838E

- Li-Ion 3,6V
- DC 5V - 2000 mA

CE

L	I	S	€	1	018380271
56,00			56,00		

1839BRW

Draadloos oplaadstation
Compatibel met 1838POCKET, 1838SW-
inspectielampen

- Twee oplaadposities met magnetische verbinding, voor gelijktijdig gebruik
- Met uittrekbare ondersteuning voor het opladen van draadloze mobiele telefoon
- Oplaadstatus LED-indicator
- Max. Invoer: 10W x2
- Input: AC 100-240V 50 / 60Hz
- OUTPUT: DC 12V 1.5A
- DC 9V 2A
- DC 5V 3A
- USB-C-poort
- Kan op de muur worden gehangen door: 3 sterke magneten op de achterkant
- 2 schroefgaten
- IP20
- IK07



L	I	S	€	1	018390002
101 mm	190 mm	28 mm	104,00		

1839/R5

USB-C QC 3.0-kabel, vervanging voor items
1838POCKET, 1839BRW

L	I	S	€	1	018390505
9,20			9,20		

1839/R6

USB Q C3.0 snellaadtransformator,
vervanging voor 1838POCKET, 1839BRW

L	I	S	€	1	018390506
26,50			26,50		

1839/R1

Transformator met USB aansluiting, onderdeel
voor artikelen 1833L/USB, 1836B, 1837F/
USB, 1838COB, 1838P, 1838S, 1838SLIM,
1838UV, 1838AM, 1838E

CE

L	I	S	€	1	018390501
27,50			27,50		

1839/R2

USB/insteekplug kabel 3.5 mm, onderdeel
voor de artikelen 1836B; 1838P; 1838COB;
1838UV

L	I	S	€	1	018390502
10,90			10,90		

1839/R4

USB/USB-C kabel, reservedeel voor artikelen
1833L/USB, 1833F/USB, 1838SLIM, 1838S,
1838AM, 1838E

L	I	S	€	1	018390504
9,65			9,65		

Beta

Beta

1842LED/BM

Inspectielamp met extra helder lichtgevende LEDs, 230 V

- 10-meter lange kabel
- Compacte behuizing vervaardigd uit anti-slip rubber
- Eenvoudig te vervangen beschermglas
- Draaibare ophanghaak
- 340 lumens
- Met dubbele LED lichtbundel

CE



1842LED/BM	L mm 230	€ 150,00	1	018420301
------------	-------------	-------------	---	-----------

1842LED/ABM

Inspectielamp met extra helder lichtgevende LEDs, 24 V

- 10-meter lange kabel
- Compacte behuizing vervaardigd uit anti-slip rubber
- Eenvoudig te vervangen beschermglas
- Draaibare ophanghaak
- 340 lumens
- Met dubbele LED lichtbundel

CE



1842LED/ABM	L mm 230	€ 143,50	1	018420311
-------------	-------------	-------------	---	-----------

HASPELS



Beta's nieuwe en uitgebreide assortiment haspels is ontworpen en ontwikkeld om aan alle eisen van professionals te voldoen.

- Het assortiment kabelhaspels omvat diverse lengtes en soorten kabels, uitvoeringen met LED-lampen en met SCHUKO-contactdozen en -stekkers.
- Het assortiment slanghaspels omvat slangen met een diameter van 8mm en 10mm.

Veer met hoge weerstand voor extra duurzaamheid en unieke soepel.

Drums gemaakt van dik polypropyleen, voor unieke schokbestendigheid.

Rack-apparaat waardoor het automatisch oprollen van de kabel stopt, eenvoudig uit te schakelen, om continu trekken mogelijk te maken.

Elke haspel is uitgerust met een 180° draaibare wandmontagebeugel en een extra beugel voor snelle aansluiting op en loskoppeling van de wandmontagesteun.

KABELHASPELS

Een breed assortiment met niet minder dan 18 versies, ontworpen om aan alle werkeisen te voldoen, inclusief de meest veeleisende gebruikers. Lengtes variërend van 10 m tot 30 m, en secties van 2x1,0 mm² tot 5Gx1,5 mm², met H05VV-F en H07RN-F kabeltypes. Alle kabelhaspels - tot een kabeldoorsnede van 3Gx2,5 mm² - worden geleverd met thermische beveiligingsschakelaars, die worden geactiveerd in geval van overbelasting van het elektrische circuit.



SLANG HASPELS



347

Een geselecteerd assortiment, met lengtes van 10 m tot 15 m, 8 mm en 10 mm in diameter, voor gebruik met pneumatisch gereedschap. Omdat onze producten lekvrij zijn, kunnen ze ook met water worden gebruikt.

Item	Geleider	Sectie	Kabel type	Lengte	Haspel zonder slang	Thermische protectie	Accessoire	
1842 15-H05/LED	018420821	2x	1,0 mm ²	H05VV-F	15+1 m	Klein	JA	LED lamp
1843 15-H05	018430215	2x	1,5 mm ²	H05VV-F	15+1 m	Klein	JA	
1844 10-H05	018440310	3G	1,5 mm ²	H05VV-F	10+1 m	Klein	JA	-
1844 15-H05	018440315			H05VV-F	15+1 m	Klein	JA	-
1844 15-H07	018440317			H07RN-F	14+1 m	Klein	YES	-
1844 30-H05	018440330			H05VV-F	30+2 m	Medium	YES	-
1844 15-H05/SCK	018440316	3G	1,5 mm ²	H05VV-F	15+1 m	Klein	JA	SCHUKO
1844 15-H07/SCK	018440318			H07RN-F	14+1 m	Klein	JA	SCHUKO
1845 12-H05	018450365	3G	2,5 mm ²	H05VV-F	12+1 m	Klein	JA	
1845 15-H07	018450367			H07RN-F	15+1 m	Medium	JA	
1845 25-H07	018450377			H07RN-F	25+1,5 m	Medium	JA	
1846 10-H05	018460405	4G	1,5 mm ²	H05VV-F	10+1 m	Klein	NEE	
1846 10-H07	018460407			H07RN-F	10+1 m	Klein	NEE	
1846 15-H05	018460415			H05VV-F	15+1 m	Klein	NEE	
1847 10-H05	018470420	4G	2,5 mm ²	H05VV-F	10+1 m	Medium	NEE	
1847 15-H07	018470427			H07RN-F	15+1 m	Medium	NEE	
1848 10-H05	018480510	5G	1,5 mm ²	H05VV-F	10+1 m	Medium	NEE	
1848 15-H07	018480517			H07RN-F	15+1 m	Medium	NEE	

Beta

1842

automatische kabelhaspel met led-inspectielamp,
100-240V

- met 230/12V veiligheidstransformator
- H05VV-F 2x1,0 mm² kabel
- opgerolde kabellengte: 15 m
- 1,5 m inkomende kabel met SCHUKO-type stopcontact
- kabellengte uit trommel: 1 m
- vergrendelsysteem kan worden uitgeschakeld.
- geleverd met een 180° draaibare beugel en een extra snelkoppelingsbeugel

CE

IP42
IP65

Model	Kabel	L (m)	€	Stk	Art. No.
1842 15-H05/LED	H05VV-F	15+1	390,00	1	018420821

1846R-LED/BM

Reserve LED lampen

12-24V - AC-DC



Model	€	Stk	Art. No.
1846LED/BM R	105,00	1	018460331

1843

automatische kabelhaspel, met 2x1,5 mm² kabel

- H05VV-F 2x1,5 mm² kabel
- met thermische beveiligingsschakelaar
- opgerolde kabellengte: 15 m
- kabellengte uit trommel: 1 m
- geleverd zonder inkomende kabel
- vergrendelsysteem kan worden uitgeschakeld.
- max. vermogen (opgerold): 1300W (230V-20 °C)
- max. vermogen (uitgerold): 2300W (230V-20 °C)
- geleverd met een 180° draaibare beugel en een extra snelkoppelingsbeugel

CE



IP42

Model	Kabel	L (m)	€	Stk	Art. No.
1843 15-H05	H05VV-F	15+1	250,00	1	018430215

1844

automatische kabelhaspel, met 3Gx1,5 mm² kabel

- 3Gx1,5 mm² kabel
- met thermische beveiligingsschakelaar
- kabellengte uit trommel: 1 m (behalve 1844 30-H05, 2 m)
- geleverd zonder inkomende kabel
- vergrendelsysteem kan worden uitgeschakeld.
- max. vermogen (opgerold): 1500W (230V-20 °C)
- max. vermogen (uitgerold): 2500W (230V-20 °C)
- geleverd met een 180° draaibare beugel en een extra snelkoppelingsbeugel"

CE



IP42

Model	Kabel	L (m)	€	Stk	Art. No.
1844 10-H05	H05VV-F	10+1	230,00	1	018440310
1844 15-H05	H05VV-F	15+1	255,00	1	018440315
1844 15-H07	H07RN-F	14+1	278,00	1	018440317
1844 30-H05	H05VV-F	30+2	495,00	1	018440330

1844SCK

automatische kabelhaspel, met 3Gx1,5 mm² kabel en SCHUKO type stopcontact

- 3Gx1,5 mm² kabel
- met thermische beveiligingsschakelaar
- kabellengte uit trommel: 1 m
- geleverd met 1,5 m inkomende kabel en SCHUKO type stopcontact
- rekmechanisme kan worden uitgeschakeld om aan de kabel te houden
- max. vermogen (opgerold): 1500W (230V-20 °C)
- max. vermogen (uitgerold): 2500W (230V-20 °C)
- geleverd met een 180° draaibare beugel en een extra snelkoppelingsbeugel

CE



IP42

Model	Kabel	L (m)	€	Stk	Art. No.
1844 15-H05/SCK	H05VV-F	15+1	270,00	1	018440316
1844 15-H07/SCK	H07RN-F	14+1	295,00	1	018440318

1845

automatische kabelhaspel, met 3Gx2,5 mm² kabel

- 3Gx2,5 mm² kabel
- met thermische beveiligingsschakelaar
- kabellengte uit trommel: 1 m (behalve 1845 25-H07RN-F, 1,5 m)
- geleverd zonder inkomende kabel
- vergrendelsysteem kan worden uitgeschakeld.
- max. vermogen (opgerold): 2000W (230V-20 °C)
- max. vermogen (uitgerold): 3000W (230V-20 °C)
- geleverd met een 180° draaibare beugel en een extra snelkoppelingsbeugel"

CE



IP42

Model	Kabel	L (m)	€	Stk	Art. No.
1845 12-H05	H05VV-F	12+1	530,00	1	018450365
1845 15-H07	H07RN-F	15+1	530,00	1	018450367
1845 25-H07	H07RN-F	25+1,5	665,00	1	018450377

1846

automatische kabelhaspel, met 4Gx1,5 mm² kabel

- 4Gx1,5 mm² kabel
- zonder thermische beveiligingsschakelaar
- kabellengte uit trommel: 1 m
- geleverd zonder inkomende kabel
- vergrendelsysteem kan worden uitgeschakeld.
- max. vermogen (opgerold): 1400W (230V-20 °C)
- max. vermogen (uitgerold): 1900W (230V-20 °C)
- geleverd met een 180° draaibare beugel en een extra snelkoppelingsbeugel"

CE



IP42

Model	Kabel	L (m)	€	Stk	Art. No.
1846 10-H05	H05VV-F	10+1	285,00	1	018460405
1846 10-H07	H07RN-F	10+1	295,00	1	018460407
1846 15-H05	H05VV-F	15+1	295,00	1	018460415



1847

automatische kabelhaspel, met 4Gx2,5 mm² kabel

- 4Gx2,5 mm² kabel
- zonder thermische beveiligingsschakelaar
- kabellengte uit trommel: 1 m
- geleverd zonder inkomende kabel
- vergrendelsysteem kan worden uitgeschakeld.
- max. vermogen (opgerold): 2000W (230V-20 °C)
- max. vermogen (uitgerold): 2700W (230V-20 °C)
- geleverd met een 180° draaibare beugel en een extra snelkoppelingsbeugel

CE



IP42



		L m	€		
1847 10-H05	H05VV-F	10+1	310,00	1	018470420
1847 15-H07	H07RN-F	15+1	550,00	1	018470427

1848

automatische kabelhaspel, met 5Gx1,5 mm² kabel

- 5Gx1,5 mm² kabel
- zonder thermische beveiligingsschakelaar
- kabellengte uit trommel: 1 m
- geleverd zonder inkomende kabel
- rekmechanisme kan worden uitgeschakeld om aan de kabel te houden
- max. vermogen (opgerold): 1400W (230V-20 °C)
- max. vermogen (uitgerold): 1900W (230V-20 °C)
- geleverd met een 180° draaibare beugel en een extra snelkoppelingsbeugel

CE



IP42



		L m	€		
1848 10-H05	H05VV-F	10+1	315,00	1	018480510
1848 15-H07	H07RN-F	15+1	599,00	1	018480517

1852R1750

Draagbaar inductie apparaat



CE

- verhit bouten, moeren en lagers zonder gebruikt te maken van open vuur, waardoor deze eenvoudiger te verwijderen zijn.
- is geschikt om elk type magnetisch metaal te verhitten

Standaard meegeleverd:

- twee opzetkop adapters, Ø 19 en 26 mm, voor het verhitten van moeren
- een plat opzet adapter voor het verhitten van oppervlakten
- een flexibele adapter, 800 mm lang
- geleverd in kunststof koffer

Technische specificatie:

- voeding: 230V AC, 50/60 Hz
- ingangsvormen: max. 7,5A
- vermogen: max. 1.75 kW

OPTIONELE TOEBEHOREN

Opzet adapters zijn eveneens verkrijgbaar in andere maten

VOORDELEN

- Tijdbesparend: snel, extreem nauwkeurige verhitting
- Brandveilig: produceert geen vlammen, maximale veiligheid voor de gebruiker
- Functioneel: te gebruiken met 1 hand, opzetadapters kunnen eenvoudig gewisseld worden

TOEPASBAAR

- Automotive industrie
- Industrieel onderhoud
- Luchtvaart industrie
- Marine industrie
- Petrochemische industrie

1852R1750	€	1.650,00	1	018520175
-----------	---	----------	---	-----------

480x370x130 mm - 4,5 kg

1852S-CNT

oprolbare gereedschapstas van duurzaam polyester, leeg



1852S-CNT	€	128,50	1	018520520
-----------	---	--------	---	-----------

1852S-CC

foudraal van duurzaam polyester, leeg



1852S-CC	€	103,50	1	018520521
----------	---	--------	---	-----------

1852S-KR/CNT

foudraal van duurzaam polyester, leeg



1852S-KR/CNT	€	56,50	1	018520522
--------------	---	-------	---	-----------

1852S-L

Hoge platte adapter



	Ø mm	M	L mm	€		
1852S-L 19	19	M6	220	52,50	1	018520501
1852S-L 20	20	M8	220	52,50	1	018520502
1852S-L 23	23	M10	220	52,50	1	018520503
1852S-L 26	26	M12	220	52,50	1	018520504
1852S-L 32	32	M16	220	52,50	1	018520505
1852S-L 38	38	M20	220	60,00	1	018520506
1852S-L 45	45	M22	220	66,00	1	018520507

1852S-F

Top adapter



	Ø mm	M	L mm	€		
1852S-F 19	19	M6	220	52,50	1	018520508
1852S-F 20	20	M8	220	52,50	1	018520509
1852S-F 23	23	M10	220	52,50	1	018520510
1852S-F 26	26	M12	220	52,50	1	018520511
1852S-F 32	32	M16	220	52,50	1	018520512
1852S-F 38	38	M20	220	60,00	1	018520513
1852S-F 45	45	M22	220	64,50	1	018520514

1852S-FLESS



	L mm	€		
1852S-FL750	750	38,50	1	018520519
1852S-FLESS	800	99,00	1	018520515
1852S-FL1000	1000	124,00	1	018520517
1852S-FL1500	1500	148,00	1	018520518

1852 S-PIATTE

Platte adapter



1852S-PIATTE	€	60,00	1	018520516
--------------	---	-------	---	-----------

Beta



LASSEN

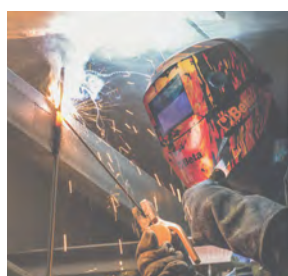

LASINVERTERS

Gebruiksvriendelijke inverter-lasapparaten met uitstekende laseigenschappen voor alle soorten elektroden. Met overspannings- en oververhittingsregeling en anti-aanbakfunctie van de elektroden. Compact en lichtgewicht, ideaal voor onderhoudsklussen in huis, de bouw en onderhoudsklussen.



LAS ACCESSOIRES

Een breed scala aan accessoires ter ondersteuning van las-werkzaamheden.



LASHELMEN

Beta biedt verschillende zelf verduisterende LCD-maskers die geschikt zijn voor verschillende soorten lassen: elektrodelassen, MIG/MAG, TIG en plasmalassen. Bescherming en comfort worden gegarandeerd door volledige naleving van alle huidige veiligheidsnormen.



GAS TIN LASMACHINES

Lasmachines en accessoires ontworpen voor kleine onderhoudsklussen en micro-elektronica klussen. Naast lasmachines met snoer biedt Beta ook verschillende butaangas-oplossingen waarmee laswerkzaamheden buitenshuis en zonder elektriciteit kunnen worden uitgevoerd.

1808

Soldeerbout met twee standen, geleverd met rechte stalen stift 1824R8



W	V	€		
20/130	230	88,00	1	018080001

1812 150

Soldeerpistool



W	V	€		
150	230	129,00	1	018120015

1814M

Soldeerbouten met stalen stiften



W	V	€		
25	230	70,00	1	018140225
30	230	75,00	1	018140230
40	230	80,00	1	018140240

1820

Soldeer pistolen



	€		
1820 30 30W L = 210mm	50,00	1	018200003
1820 60 60W L = 220mm	60,00	1	018200006
1820 80 80W L = 260mm	88,00	1	018200008

1822

Soldeerbouten



	€		
1822 120 120W LxA = 250x125 mm	135,00	1	018220012
1822 180 180W LxA = 250x125mm	145,00	1	018220018
1822 320 320W LxA = 250x140mm	180,00	1	018220032

1823 60

Digitaal soldeestation, soldeerbout meegeleverd

- Temperatuur bereik: 160 °C + 480 °C met ±1% nauwkeurigheid.
- Geheugenstand voor het behouden van de ingestelde temperatuur na het uitschakelen van het apparaat.
- 3 voor ingestelde temperatuur selecties knoppen (200-300-400 °C).



W	€		
60	520,00	1	018230060

1823R/60

Reserve soldeerbout voor artikel 1823 60



	€		
1823R 60	105,00	1	018230066



1824R

Reserve stiften voor soldeerbouten

	€		
1824R 08 1808	39,00	1	018240100
1824R 12 1812/150	5,80	1	018240301
1824R 14-M25 1814M/25	5,10	1	018240152
1824R 14-M30 1814M/30	5,10	1	018240153
1824R 14-M40 1814M/40	5,10	1	018240154
1824R 20 1820/30	6,95	1	018240302
1824R 60 1820/60	7,30	1	018240303
1824R 80 1820/80	10,10	1	018240304
1824R 120-180 1822/120 -/180	86,50	1	018240305
1824R 320 1822/320	105,00	1	018240307
1824R ST-60 1823-60	13,40	1	018240308

1825B

Soldeertin draad met anti-oxydatie

- 1 mm²; 250 g
- Sn 99.3%; Cu 0.7%



	€		
1825B	79,00	1	018250251

1827

Gassoldeer apparaat, instelbaar



	€		
1827	162,00	1	018270001

1827PC

Reserve conische stiften voor item 1827



	€		
1827PC 1,6	33,50	1	018270501
1827PC 3,2	33,50	1	018270502

1827PCL

Reserve mesvormige stiften voor item 1827



	€		
1827PCL 2,4	33,50	1	018270503

1827PFL

Reserve open stift voor item 1827



1827PFL € 33,50 1 018270504

1827/K

Gassoldeer apparaat met 7 toebehoren in koffer met polyethyleen inleg



- Vermogen: 30 watt tot 125 watt
- Tip temperatuur is regelbaar tussen 250 °C en 500 °C
- Regelbare gashendel
- Gebruiksklaar na: 15 seconden
- Gastank inhoud geschikt voor 120 minuten werking
- Gastank voorzien van kijkglas
- Geschikt voor butaan gas.

1827/K € 260,00 1 018270100

1827F

butaan gas soldeer pistool

35 g tank

- drie verwisselbare mondstukken: 550 °C; 1000 °C; 1300 °C
- Geleverd met een standaard in een hard koffertje



1827F € 180,00 1 018270200

1830T

Tinzuiger met anti-statische plastic zuigbuis



L mm 190 € 21,50 5 018300021

1860BH/120A

DC-aangedreven inverter lasmachine voor MMA-lassen met rutiel-, basis- en roestvrijstalen elektroden, compact en gemakkelijk mee te nemen

Arc force, hot start, anti-kleef en thermostatische beschermingsfuncties

Lasstroom bereik: 10÷120A
Voeding: 1x230V

Inschakelduur bij (40 °C) :
25% - 120 A
50% - 80 A
100% - 60 A
Beschermingsklasse: IP22S
Bruikbare elektrode: Ø 1.6 - 3.2mm rutilic, basis, roesvaststaal, gietijzer enz.
Geleverd met 16mm² kabels

CE



1860BH/120A € 399,00 1 018600121

1860BH/160A

DC-aangedreven inverter lasmachine voor MMA-lassen met rutiel-, basis- en roestvrijstalen elektroden, compact en gemakkelijk mee te nemen

Arc force, hot start, anti-kleef en thermostatische beschermingsfuncties

Lasstroom bereik: 10÷160A
Voeding: 1x230V

Inschakelduur bij (40 °C) :
25% - 160 A
60% - 100 A
100% - 80 A
Beschermingsklasse: IP22S
Bruikbare elektrode: Ø 1.6 - 4mm rutilic, basis, roesvaststaal, gietijzer enz.
Geleverd met 16mm² kabels

CE



1860BH/160A € 499,00 1 018600161

1860BH/200A

DC-aangedreven inverter lasmachine voor MMA-lassen met rutiel-, basis- en roestvrijstalen elektroden, compact en gemakkelijk mee te nemen

Arc force, hot start, anti-kleef en thermostatische beschermingsfuncties

Lasstroom bereik: 10÷200A
Voeding: 1x230V

Inschakelduur bij (40 °C) :
25% - 200 A
60% - 130 A
100% - 100 A
Beschermingsklasse: IP22S
Bruikbare elektrode: Ø 1.6 - 4mm rutilic, basis, roesvaststaal, gietijzer enz.
Geleverd met 16mm² kabels

CE



1860BH/200A € 576,00 1 018600201

1860BH R/CM

reserve aardkabel voor inverter lasapparaten 1860BH-120/160/200A



1860BH R/CM € 55,50 1 018600612

1860BH R/CS

reserve laskabel met elektrodehouder voor inverter lasapparaten 1860BH-120/160/200A



1860BH R/CS € 67,50 1 018600613

1860BHT/160A

DC-aangedreven inverter lasapparaat voor MMA en TIG elektrode staal lassen, compact en gemakkelijk mee te nemen

Arc force, STICK/TIG (lift arc), hot start, anti-sticking en thermostatische beschermingsfuncties

instelstroom: 10÷160 A
voeding: 1x230 V

gebruiksfactor (40 °C):
60% - 160 A
100% - 130 A

bescherming: IP23S

bruikbare elektroden: Ø 1,6 - 4 mm, rutiel, basisch, roestvrij staal.

Geleverd met 25 mm² kabels

CE



1860BHT/160A € 999,00 1 018600179

1860BHT R/CM

reserve aardkabel voor TIG lasapparaten 1860BHT



1860BHT R/CM € 86,50 1 018600616

1860BHT R/CS

reserve laskabels voor TIG-lasmachines 1860BHT



1860BHT R/CS € 111,00 1 018600617

1860BHT/T

TIG-fakkels voor TIG-lasapparaten 1860BHT
lengte: 4m
aansluiting: 50 mm2



1860BHT/T € 285,00 1 018600615

1860M

Magnetische, snel vertelbare las hoek klem

Met verstelbare klemmen,

Ideaal voor het vergrendelen van verschillende delen

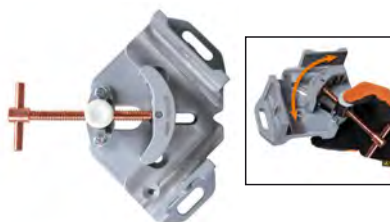

1860M L max mm 30 € 99,00 1 018600301

1860DM

magnetische schijven voor het optillen van metalen platen

ideaal voor het hanteren en bevestigen van metalen platen
constante magnetische kracht over het gehele schijfoppervlak
handgrepen met gaten voor eenvoudiger verticaal werken



1860DM 16 kg max 16 € 59,50 1 018600310
1860DM 40 40 € 83,50 1 018600311

1860PMIG

multifunctionele tang voor MIG-lassen



1860PMIG L mm 215 L1 mm 44 € 43,50 2 018600350

1860EI

Magnetische laswinkelhaak, 90°, voor binnen en buitenhoeken

Ideaal voor het vergrendelen van ronde of platte delen, 18 kg magnetische kracht, met schuine kanten voor 30° en 60° hoeken, met zeshoekig gat waardoor het gemakkelijker is om de magneet van metaal te scheiden



1860EI L mm 165 L1 mm 110 S mm 35 € 41,50 1 018600290

1860RG

Instelbare magnetische laswinkelhaak, 30°÷270°

Ideaal voor het vergrendelen van buisvormige of platte delen, 15 kg magnetische kracht, geleverd met een haakse binnenzeskantsleutel voor het instelmechanisme van de vergrendelingshoek, geleverd met een pin voor het vergrendelingsmechanisme voor hoekverstelling op 30° -45° -90° / 270° -180° met zeshoekig gat waardoor het gemakkelijker is om magneet van metaal te scheiden



1860RG L mm 155 S mm 35 € 67,00 1 018600255

1860SQ

Lasmagneet hoek model, 45°/90°

Ideaal voor het vasthouden van ronde of platte delen
25 kg magnetische trekkracht

Geen batterij nodig, AAN/UIT schakeling door het kantelen van de interne magneten

Eenvoudig spaanders te verwijderen met de magneten in de UIT stand



1860SQ € 103,00 1 018600210





7041LCD/4S

Automatische LCD lashelm, voor elektrode lassen van; MIG/MAG; TIG en plasma.

4 sensors met "TRUE COLOR" filter
Zonnecel voeding en lithium batterijen voor een lange levensduur van het LCD filter

- Zichtvlak: 98x80 mm
- Variabele donkertint: 5+8.5/ 9-13, van binnen verstelbaar
- UV/IR bescherming: DIN16
- Schakeltijd tot donker: 1/25000 s
- Schakeltijd tot licht: 0.1-2.0s
- Instelbare donker intensiteit en vertraging
- Automatische aan/uit
- Slijp instelling
- Lage batterijspannings weergave

- Ergonomische design, lichtgewicht, uitgebalanceerd
- Instelbaar door draaiknop



7041LCD/4S € 333,00 1 070410001

7041LCD/4S-VE

Krasvaste lensbescherming voor artikel 7041LCD/4S

7041LCD/4S-VE € 8,75 2 070410101

7041LCD/4S-VI

Binnenglas voor artikel 7041LCD/4S

7041LCD/4S-VI € 3,95 2 070410102

7042LCD

Automatische LCD lashelm, voor elektrode lassen van: MIG/MAG; TIG en plasma.
Zonnecellen laden automatisch de lithium batterij en garanderen een lange levensduur

- Zichtvlak: 98x43 mm
- Kleur (licht-donker): DIN 9-13, extern instelbaar
- UV/IR protectie
- Schakeltijd tot donker: 1/25000 s
- Schakeltijd tot licht: 0.25-1s
- Regelbare donker intensiteit en inschakeling
- Auto aan/uit
- Slijp instelling
- Optimale vormgeving om het gemakkelijk te ademen met een dicht venster



7042LCD € 224,50 1 070420001

7042LCD/RV

Krasbestendige lensbescherming voor artikel 7042LCD, 7043

7042LCD/RV € 3,75 2 070420101

7042LCD/RV-INT

Binnenglas voor artikel 7042LCD, 7043

7042LCD/RV-INT € 3,35 2 070420102

7043

Automatische LCD lashelm, voor elektrode lassen, MIG/MAG, TIG en plasma,
Voeding door zonnecellen

- Zichtvlak: 92x43 mm
- Kleur (licht-donker): DIN 9-13, extern instelbaar
- UV/IR bescherming
- Schakeltijd tot donker: 1/1000 s
- Schakeltijd tot licht: 0.1-1.0 s
- Regelbare donker inschakeling
- Automatisch aan/uit schakeling
- Slijp instelling
- Optimale vormgeving om goed te kunnen ademen met een omlaaggetrokken kap



7043 € 130,00 1 070430001

VOERTUIG REPARATIE

Onze reparatie gereedschappen voor voertuigen, die worden gebruikt door de meest veeleisende professionals, zijn ontwikkeld en vervaardigd om te voldoen aan de hoogste normen ter wereld en worden regelmatig getest onder de meest stressvolle bedrijfsomstandigheden.
Al meer dan 50 jaar werken we met trots samen met de grootste kampioenen, die ons non-stop helpen onze producten te verbeteren en te bewijzen volgens de hoogste kwaliteitsnorm.

De voertuig reparatie gereedschappen zijn te vinden in deze secties:

Diagnose	artikel 1438 tot 1499 artikel 1758VT tot 1760TMC
Mototr	artikel 955 tot 989A artikel 1438 tot 1499
Olie en filters	artikel 1438 tot 1499 artikel 1877 tot 1885
Elektrisch systeem	artikel 1438 tot 1499
Startboosters	artikel 1498BC/12 tot 1498/40A
Versnelling	artikel 1438 tot 1499
Ophanging	artikel 1549 tot 1569CP
Remmen	artikel 1438 tot 1499
Wielen	artikel 955 tot 989A
Carrosserie gereedschap	artikel 1302 tot 1369 artikel 1763 tot 1767A
Overig gereedschap	artikel 1875LT tot 3067
Garagekriks	artikel 3029/2T tot 3067/70-13T



1875LT

injectie/extractie tapijt/bekleding reiniger

Ideaal voor het grondig reinigen van textieloppervlakken. Het geeft onder druk gespoten reinigingsmiddel af en zuigt dit weer op tegelijk met het vuil, waardoor de oppervlakken nagenoeg droog achterblijven.

Meegeleverde accessoires:

- 1 slang compleet met ergonomische handgreep
- 1 dispenser unit
- 2 verleng delen
- 1 kleine sproei-extractiekop
- 1 grote sproei-extractiekop
- 6 borgmoeren voor het netsnoer

CE



1875LT	€ 675,00	1	018750000
--------	----------	---	-----------

1875SP/K3

set reinigingsborstels

- 1 platte borstel Ø 48 mm
- 1 platte borstel Ø 100 mm
- 1 halfronde borstel Ø 90 mm
- 1/4" aansluiting

1/4



ISO 1173 E 6,3

1875SP/K3	€ 19,00	1	018750010
-----------	---------	---	-----------

1877

Olieopvangbak, verrijdbaar, met 90 liter tank

- Niveau indicator
- Grote diameter van de opvangbak voorzien van een rooster; capaciteit: 12 l
- Tank pneumatisch te legen met 1,8 meter slang
- Gereedschapsbakje

CE



1877	€ 805,00	1	018770008
------	----------	---	-----------

1877A

Olie opvang en afzuig unit, verrijdbaar, met 90 l tank en kijkglas

- Niveau indicator
- Grote diameter opvangbak met rooster; capaciteit: 12 l
- Groot kijkglas: capaciteit 9.5 l
- 1.8 m lange afzuigslang
- Tank pneumatisch te legen met 1.8 meter slang
- Gereedschapsbakje

Standaard toebehoren:

- 1 harde sonde, Ø 5x700 mm
- 1 flexibele sonde, Ø 5x700 mm
- 1 harde sonde, Ø 6x600 mm
- 1 flexibele sonde, Ø 6x700 mm
- 1 flexibele sonde, Ø 7x700 mm
- 1 flexibele sonde, Ø 8x700 mm
- Adapters voor VW, BMW, CITROËN

CE



1877A	€ 1.430,00	1	018770080
-------	------------	---	-----------

1877F

olie opvangunit voor het legen van 1 liter flessen

- tot een maximum van 4 flessen tegelijk
- Wordt geleverd met 2 opvang tanks van 2 liter



H mm	L mm	P mm	€	1	018770100
405	270	240	109,50		

1877P

Olieopvangbak, verrijdbaar met polyethyleentank

- tankinhoud: 40 l
- grote oliepan van PP
- niveau-indicator
- pneumatisch legen van vaten



	H min-max mm	H1 mm	l	€	1	018770180
1877P	1030-1630	900	40	449,00		

1878 2

Vloeistof opvangbak

- Maximale capaciteit: 2 l
- Uitermate geschikt voor het verversen van olie bij scooters



1878 2	l	H mm	€	1	018780002
	2	85	15,30		

1878 3

Vloeistof opvangbak, voor vrachtwagenassen Met oliedruppel vanger



1878 3	l	€	1	018780003
	3	22,50		

1878 4

Vloeistof opvangbak, draagbaar

- Geschikt voor motorfietsen
- Maximale capaciteit: 4 l
- Gereduceerd spatten



1878 4	l	H mm	€	1	018780004
	4	100	32,00		

1878 8

Vloeistof opvangbak

- Door de hoogte is deze geschikt voor motorfietsen
- Maximale capaciteit: 8 l



1878 8	8	H mm 110	€ 17,00	1	018780008
--------	---	----------------	------------	---	-----------

1878 11

Vloeistof opvangbak

- Maximale capaciteit: 11 l
- Aftapplug
- Dubbel wand constructie voorkomt lekkage tijdens transport



1878 11	11	€ 36,00	1	018780011
---------	----	------------	---	-----------

1878 30

Vloeistof opvangbak

- Maximale capaciteit: 30 l
- Anti spat rooster
- Voorzien van 4 zwenkwielen

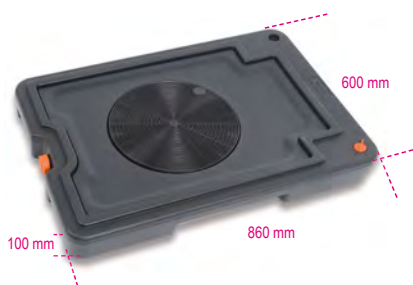

1878 30	30	€ 142,50	1	018780030
---------	----	-------------	---	-----------

1879

9.5 l hand/lucht bediende vloeistof afzuigapparaat



1879 9.5	€ 316,00	1	018790001
----------	-------------	---	-----------

1879 6

Handmatig bediende vloeistof afzuigapparaat, 6 l



1879 6	€ 231,50	1	018790000
--------	-------------	---	-----------

1879R/K4

Set van 4 reserve slangen voor water en stofzuiger artikel 1879



1879R/K4	€ 62,50	1	018790504
----------	------------	---	-----------

1879/FUEL

Handmatig bediende vloeistof afzuigapparaat, 6 l

Geschikt voor het gebruik met koolwaterstoffen



1879/FUEL	6	€ 135,50	1	018790010
-----------	---	-------------	---	-----------

1880

vatpomp handbediening

- voor olie
- niet gebruiken met waterige vloeistoffen, zure oplosmiddelen, dieselolie, benzine en dergelijke
- compleet met tonaansluiting, telescopische buis en schenkruit
- voor gebruik met vaten van 60, 100 en 200 l



1880	gr 240	€ 66,00	1	018800001
------	-----------	------------	---	-----------

1880ADB

Roterende AdBlue® vatpomp

- 5 liter capaciteit per twintig omwentelingen
- Zuigbuis verlenging tot 1.20 m
- 1 fijne draad vataansluiting
- 1 grove draad vataansluiting



1880ADB	€ 150,00	1	018800101
---------	-------------	---	-----------

1881

Pneumatische vatpomp, ratio 3:1

CE



1881	l/min 18	€ 574,00	1	018810001
------	-------------	-------------	---	-----------

1882N

Olieafgifte pistool met flexibel mondstuk en druppelvanger



1882N	€ 165,00	1	018820110
-------	-------------	---	-----------

1883N

Digitale oliemeter



1883N	€ 256,00	1	018830036
-------	-------------	---	-----------

1883NC

verbindingsnippel, 1/2,
voor artikelen 1882N en 1883N



1883NC € 14,00 1 018830135

1884

Olie vulapparaat
voor handgeschakelde- en automatische
versnellingsbakken en differentieel
Compleet met 12 adapters voor rechtstreekse aansluiting



1884 € 551,00 1 018840010

AT-101	FORD
AT-102	UNIVERSAL (Bmw, Honda, Nissan...)
AT-103	VW-AUDI
AT-104	VW-AUDI-PORSCHE
AT-105	VW-AUDI-MINI COOPER
AT-106	MERCEDES
AT-107	DSG
AT-108	VW-AUDI CVT
AT-109	VOLVO
AT-110	TOYOTA-LEXUS
AT-111	SKODA
AT-112	VW Passat/Tiguan <2007

1884/C12

Koffer met adapters voor artikel 1884



1884/C12 € 206,50 1 018840100

1884N/C8

8-delig set adapters voor artikel 1884

Set bevat:

- 1 adapter voor Infiniti, 7-speed, M8x1.0
- 1 adapter voor Honda, Hyundai, Kia 5x8x200 mm
- 1 adapter voor Skoda M18x1.5
- 1 adapter voor Mini M14x1.5
- 1 adapter voor Nissan M10x1.5
- 1 adapter voor Nissan Juke M12x1.25
- 1 adapter voor GM M12x1.75
- 1 adapter voor VAG groep voertuigen, 7-versnellingen



1884N/C8 € 133,00 1 018840200

200x145x40 mm - 400 g

1889N

Stalen lekbak en opslag voor olievaten 2 200-l
vaten

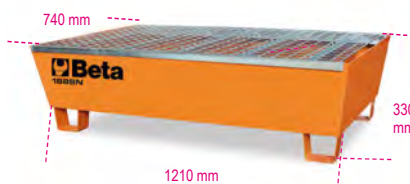

1889N € 894,00 1 018890220

1889CF

Universele vatensleutel

- 1 zeskant inwendige aansluiting Ø 38 mm
- 1 4-puntig profiel Ø 42 mm
- 1 groef profiel 17x7 mm



L mm 270 € 39,00 1 018890010

1885

Service apparaat voor automatische
versnellingsbakken

Spoelt en reinigt op een veilige manier alle automatische
versnellingsbakken door een eenvoudige en begeleide
procedure.

Voorkomt schade aan de automaat door verouderde en
vervuilde olie en verhelpt eenvoudig en snel typische foute
kenmerken zoals:

excessief ratelgeuid, geblokeerde versnellingen,
onverwachte geblokeerde versnelling, lange schakeltijd.



FUNCTIONELE SPECIFICATIES

Automatische werking

Stap voor stap begeleide procedure met geïntegreerde
database

Uitgebalanceerde hoeveelheid van de vervangen olie welke
overeenkomt met de afgenomen hoeveelheid olie, met een
zekerheid dat het systeem altijd gevuld wordt met de
voorgeschreven hoeveelheid olie.

Kijkglas voor de visuele inspectie van de oliehoeveelheid.

Afdruk specificaties van elke operatie.

AUTOMATISCHE SPECIFICATIES

Toevoer reinigingsvloeistof (optioneel)

Spoelen van het versnellingsvat systeem

Het legen van de olie uit de carter

Het legen van de olie uit de koppelvormer

Het vullen met olie van de koppelvormer

TECHNISCHE SPECIFICATIES

Voeding: 220 V 50 Hz

Verlichte scherm met olie meters met 2 witte licht LEDs

2 elektronische weegschalen

Electronische weegschaal, nauwkeurigheid +/- 10 g

Electronisch scherm met grafische weergave

1885 € 9.280,00 1 018850010



1885/C1

Set van aansluitingen voor automatische versnellingsbakken passend op artikel 1885

Set bevat:

- 1885/C1-R1 Land Rover Freelander versnellingsbak aansluiting
- 1885/C1-R2 DP0 versnellingsbak aansluiting
- 1885/C1-R3 ZF 9HP versnellingsbak aansluiting
- 1885/C1-R4 ZF 9HP versnellingsbak peilstok
- 1885/C1-R5 Mercedes versnellingsbak peilstok
- 1885/C1-R6 AISIN TG82 versnellingsbak aansluiting
- 1885/C1-R7 AISIN TG81 versnellingsbak aansluiting
- 1885/C1-R8 Renault-Nissan versnellingsbak aansluiting



1885/C1 € 824,00 1 018850110

1885/C1-R1

Land Rover Freelander versnellingsbak aansluiting voor artikel 1885
lc01430



1885/C1-R1 € 72,50 1 018850111

1885/C1-R2

DP0 versnellingsbak aansluiting voor artikel 1885
lc0990



1885/C1-R2 € 125,00 1 018850112

1885/C1-R3

ZF 9HP versnellingsbak aansluiting voor artikel 1885
lc0992



1885/C1-R3 € 139,00 1 018850113

1885/C1-R4

ZF 9HP versnellingsbak peilstok voor artikel 1885
lc0192



1885/C1-R4 € 78,00 1 018850114

1885/C1-R5

Mercedes versnellingsbak peilstok voor artikel 1885
K-A-M



1885/C1-R5 € 129,00 1 018850115

1885/C1-R6

AISIN TG82 versnellingsbak aansluiting voor artikel 1885
lc01820



1885/C1-R6 € 138,50 1 018850116

1885/C1-R7

AISIN TG81 versnellingsbak aansluiting voor artikel 1885
lc0150



1885/C1-R7 € 138,50 1 018850117

1885/C1-R8

Renault-Nissan versnellingsbak aansluiting voor artikel 1885
lc02150



1885/C1-R8 € 138,50 1 018850118

1885/C2

Set van aansluitingen voor automatische versnellingsbakken passend op artikel 1885

Set bevat:

- 1885/C2-R1 Audi 8HP versnellingsbak aansluiting
- 1885/C2-R2 ZF 9HP versnellingsbak aansluiting zonder wisselaar
- 1885/C2-R3 Audi 0KC versnellingsbak aansluiting
- 1885/C2-R4 AG4-ZF 4HP versnellingsbak aansluiting
- 1885/C2-R5 FIAT versnellingsbak aansluiting
- 1885/C2-R6 Audi Q5-Q7 versnellingsbak aansluiting
- 1885/C2-R7 Audi 0B5 versnellingsbak aansluiting



1885/C2 € 670,00 1 018850120

1885/C2-R1

Audi 8HP versnellingsbak aansluiting voor artikel 1885
lc0993



1885/C2-R1 € 135,50 1 018850121

1885/C2-R2

ZF 9HP versnellingsbak aansluiting zonder wisselaar voor artikel 1885
lc0860



1885/C2-R2 € 88,50 1 018850122

1885/C2-R3

Audi 0KC versnellingsbak aansluiting voor artikel 1885
lc02020



1885/C2-R3 € 138,50 1 018850123

1885/C2-R4

AG4-ZF 4HP versnellingsbak aansluiting voor artikel 1885
lc0750



1885/C2-R4 € 117,50 1 018850124

1885/C2-R5

FIAT versnellingsbak aansluiting voor artikel 1885
lc0061



1885/C2-R5 € 52,50 1 018850125

1885/C2-R6

Audi Q5-Q7 versnellingsbak aansluiting voor artikel 1885
lc0680



1885/C2-R6 € 129,00 1 018850126

1885/C2-R7

Audi 0B5 versnellingsbak aansluiting voor artikel 1885
lc01720



1885/C2-R7 € 77,50 1 018850127

1885/C3

Set van aansluitingen voor automatische versnellingsbakken passend op artikel 1885

Set bevat:

- 1885/C3-R1 Mercedes DSG versnellingsbak aansluiting
- 1885/C3-R2 POWERSHIFT versnellingsbak aansluiting
- 1885/C3-R3 Toyota IQ versnellingsbak aansluiting
- 1885/C3-R4 Mazda versnellingsbak aansluiting
- 1885/C3-R5 Renault Laguna-Esp versnellingsbak aansluiting
- 1885/C3-R6 Nissan Juke versnellingsbak aansluiting
- 1885/C3-R7 AISIN TF71 FV versnellingsbak aansluiting
- 1885/C3-R8 AISIN TF71 FP versnellingsbak aansluiting
- 1885/C3-R9 AISIN TF71 FO versnellingsbak aansluiting
- 1885/C3-R10 AISIN TF71 FS versnellingsbak aansluiting



1885/C3 € 1.180,00 1 018850130

1885/C3-R1

lc0191



1885/C3-R1 € 138,50 1 018850131

1885/C3-R2

POWERSHIFT versnellingsbak aansluiting voor artikel 1885
lc0190



1885/C3-R2 € 138,50 1 018850132

1885/C3-R3

Toyota IQ versnellingsbak aansluiting voor artikel 1885
lc0991



1885/C3-R3 € 138,50 1 018850133

1885/C3-R4

Mazda versnellingsbak aansluiting voor artikel 1885
lc02130



1885/C3-R4 € 138,50 1 018850134

1885/C3-R5

Renault Laguna-Esp versnellingsbak aansluiting voor artikel 1885
lc02150



1885/C3-R5 € 138,50 1 018850135

1885/C3-R6

Nissan Juke versnellingsbak aansluiting voor artikel 1885
lc02140



1885/C3-R6 € 138,50 1 018850136

1885/C3-R7

AISIN TF71 FV versnellingsbak aansluiting voor artikel 1885
lc01420



1885/C3-R7 € 138,50 1 018850137

1885/C3-R8

AISIN TF71 FP versnellingsbak aansluiting voor artikel 1885
lc001420/1



1885/C3-R8 € 138,50 1 018850138

1885/C3-R9

AISIN TF71 FO versnellingsbak aansluiting voor artikel 1885
lc001420/2



1885/C3-R9 € 138,50 1 018850139

1885/C3-R10

AISIN TF71 FS versnellingsbak aansluiting voor artikel 1885
lc001420/3



1885/C3-R10 € 138,50 1 018850140

1885/XC60

Volvo XC60 transmissie fittingen voor artikel 1885



1885/XC60 € 149,50 1 018850151

1893/134A

Volautomatisch service station voor R134a gas airconditioning

Volledig automatisch model, compleet met voertuig database met gas hoeveelheden, compressorolie hoeveelheden en welke types, zelfstellende diagnose software voor routine onderhoud werkzaamheden.

Database kan geupdate worden via software. Het apparaat werkt zowel handmatig (waarbij de monteur stap voor stap de werking controleerd) en in de volautomatische instelling (geen monteur nodig tijdens het proces).



R134A (250 ml)

FUNCTIONELE SPECIFICATIES

Automatische werking
Voertuig- aanhangwagen database met gas, compressorolie hoeveelheden en types
Automatische gas herstel van het systeem
Compensatie van de hoeveelheid vervangen gas in het systeem
Automatische onttrekking van niet condenseerbare gassen
Automatische verslag van storingen en aanbevolenonderhouds werkzaamheden
Meters, ø 80 mm
Digitale vacuometer

TECHNISCHE SPECIFICATIES

Gas tank: 15 kg
Vacuum pomp: 75 l/min
Elektronische weegschaal: 50 kg
Electronisch verlicht scherm
Herstel graad: 500 rpm
Voeding: 220 V

1893/134A € 6.310,00 1 018930001

1893/1234YF

Volautomatisch service station voor R1234yf gas airconditioning

Volledig automatisch model, compleet met voertuig database met gas hoeveelheden, compressorolie hoeveelheden en welke types, zelfstellende diagnose software voor routine onderhoud werkzaamheden.

Database kan geupdate worden via software.

Het apparaat werkt zowel handmatig (waarbij de monteur stap voor stap de werking controleert)

en in de volautomatische instelling (geen monteur nodig tijdens het proces).



CE



1234YF (250 ml)

FUNCTIONELE SPECIFICATIES

Automatische werking

Voertuig- aanhangwagen database met gas, compressorolie hoeveelheden en types

Automatische gas herstel van het systeem

Compensatie van de hoeveelheid vervangen gas in het systeem

Automatische onttrekking van niet condenserbare gassen

Automatische verslag van storingen en aanbevelenonderhouds werkzaamheden

Meters, ø 80 mm

Digitale vacuometer

TECHNISCHE SPECIFICATIES

Gas tank: 15 kg

Vacuumpomp: 75 l/min

Elektronische weegschaal: 50 kg

Electronisch verlicht scherm

Herstel graad: 500 rpm

Voeding: 220 V

1893/1234YF € 6.540,00 1 018930012

1893TR/134A

R134a gas detectie additief



1893TR/134A ml 250 € 45,00 1 018930901

1893TR/1234YF

R1234yf gas detectie gas additief



1893TR/1234YF ml 250 € 50,50 1 018930902

1893TR/CI

Lekdetectie UV additief voor airco



1893TR/CI ml 250 € 53,00 1 018930903

1895G

Testgenerator voor (benzine en LPG) elektrische injectoren en magneetventielen

Maakt het mogelijk om autonoom de efficiëntie te testen van delen zoals:

- EGR magneetkleppen
- Elektrische-injectoren van benzine en LPG motoren
- Magneetkleppen voor variabele geometrische turbine instelling
- Compressoren voor de nieuwe generatie airco's



CE

VOORDELEN

- Maakt het mogelijk om vast te stellen of het deel mechanisch werkt.
- Gecombineerd met een ultrasonische reinigingsstank, is het mogelijk de delen efficiënt reinigen en gelijktijdig deze elektronisch te controleren tijdens de spoelfase.
- Essentieel voor het testen van de airco, om te controleren of de compressor en controle klep efficiënt werken.

SPECIFICATIES

- Benzine en LPG injectore controle:

- Uitgangen aantal: 4

- Test tijdsduur: 1-60 s

- Werkingsduur: 5-10 ms

- Impuls frequentiebereik: 1-10 Hz

PWM controle:

- Uitgangen aantal: 1

- Testduur: 1-60 min

- Automatisch of handmatig

- Werkingscyclus instelling: 10%-85%

- Signaal frequentie regeling: 120-250 Hz

Omvat 4 connectoren met insteek FASTON aansluitingen

Voeding: 110-220 V

Afmetingen: 334x240x74 mm

Gewicht: 4 kg

1895G € 2.095,00 1 018950800

1895/S

Instelbare steun voor de ultrasonische reiniging tanks 1895

Houdt de injectoren in de juiste positie in de tank tijdens het ultrasonisch reinigen

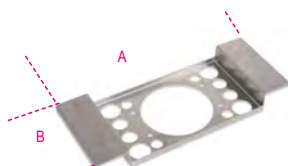

1895S A mm 340 B mm 140 € 126,00 1 018950501

1895 6

Ultrasonische reinigingsstank, 6 ltr

met een speciale ontgassingsfunctie



CE

- Ultrasonisch reinigen is gebaseerd op het verhitten van vloeistof om zodoende onderdelen en metalen delen in het algemeen (injectoren, carburateurs, kleppen enz) effectief te reinigen.

- Digitaal scherm voor weergave van temperatuur en tijdstelling

- Twee reinigingsopties: "zacht" en "normaal"

- Voor standaard reiniging, gebruik water met een temperatuur van 50/60 °C

- Voor een meer accuratereiniging, voeg een niet schuimend schoonmaakmiddel toe welke specifiek geschikt is voor ultrasonische apparaten

- Bij gebruik van de ontgassings functie zal de lucht sneller worden afgevoerd uit de tank, waardoor de reiniging efficiënter wordt.

TECHNISCHE GEGEVENS

Tank capaciteit: 6 l

Aftapkraan

Vermogen: 150 W

Verwarmings vermogen: 300 W

Temperatuur bereik: 0+80 °C

Tijdstelling reiniging: 0-99 minutes

Frequentie: 40 kHz

Voeding: 220/230V

Buiten afmeting: 330x180x310 mm

Tank afmeting: 300x155x150 mm

Korf afmeting: 250x105x100 mm

Maximale capaciteit: 5.5 kg

1895 6 Max 5,5 € 749,00 1 018950060

1895 13

Ultrasonische reinigingsstank, 13 ltr

met een speciale ontgassingsfunctie



CE

- Ultrasonisch reinigen is gebaseerd op het verhitten van vloeistof om zodoende onderdelen en metalen delen in het algemeen (injectoren, carburateurs, kleppen enz) effectief te reinigen.

- Digitaal scherm voor weergave van temperatuur en tijdstelling

- Twee reinigingsopties: "zacht" en "normaal"

- Voor standaard reiniging, gebruik water met een temperatuur van 50/60 °C

- Voor een meer accuratereiniging, voeg een niet schuimend schoonmaakmiddel toe welke specifiek geschikt is voor ultrasonische apparaten

- Bij gebruik van de ontgassings functie zal de lucht sneller worden afgevoerd uit de tank, waardoor de reiniging efficiënter wordt.

TECHNISCHE GEGEVENS

Tank capaciteit: 13 l

Aftapkraan

Vermogen: 300 W

Verwarmings vermogen: 400 W

Temperatuur bereik: 0+80 °C

Tijdstelling reiniging: 0-99 minutes

Frequentie: 40 kHz

Voeding: 220/230V

Buiten afmeting: 350x325x320 mm

Tank afmeting: 325x235x145 mm

Korf afmeting: 257x185x100 mm

Maximale capaciteit: 12 kg

1895 13 Max 12 € 1.555,00 1 018950130

1895 27

Ultrasonische reinigingstank,
27 l

Met een speciale ontgassings functie



CE

- Ultrasonisch reinigen is gebaseerd op het verhitten van vloeistof om zodoende onderdelen en metalen delen over het algemeen (injectoren, carburateurs, kleppen enz.) effectief te reinigen
- Digitale weergave van temperatuur en tijdstelling
- Twee reinigings opties: "zacht" en "normaal"
- Voor normale reiniging, gebruik water met een temperatuur van 50/60 °C
- Voor een meer accurate reiniging, voeg een niet schuimend schoonmaak middel toe welke specifiek geschikt is voor ultrasonisch apparaten.
- Bij gebruik van de ontgassing functie zal de lucht sneller worden afgevoerd uit de tank, voor een betere en efficiëntere reiniging.

TECHNISCHE GEGEVENS

Tank capaciteit: 27 l
Aftapkraan
Vermogen: 500 W
Verwarmings vermogen: 500 W
Temperatuur bereik: 0÷80 °C
Tijdstelling reiniging: 0-99 minuten
Frequentie: 40 kHz
Voeding: 220/230V
Afmetingen: 530x330x380 mm

1895 27	Max 25	€	1.595,00	1	018950270
---------	-----------	---	----------	---	-----------

1895/RC

Inzetmand voor ultrasonische reinigings tanks
1895



	L mm	L1 mm	A mm	€		
1895/RC6	250	105	100	46,50	1	018950506
1895/RC13	257	185	100	73,50	1	018950513
1895/RC27	450	250	150	122,00	1	018950527

9881U



9881U 1 (1-2)	567
9881U 1 (3)	567

9882R



9882R 1 (1-2)	567
9882R 1 (3)	567

1897

Professionele straalcabine, tafelmodel

Uitermate aanbevolen voor het stralen van oppervlakten van verschillende materialen (metaal, kunststof, glas, keramiek, hout, enz.). De cabine is zorgvuldig vervaardigd uit verstevigd plaatstaal met als resultaat ongeëvenaarde stijfheid en stevigheid.

De cabine is voorzien van het volgende:

- Toegangsdeur met magneet sluiting
- Geperforeerd stalen werkblad
- Standaard aansluiting voor stofzuigers, ø 36 mm
- Beschermende polycarbonaat kijkscherm, 6 mm
- LED lamp
- Pneumatisch systeem (compressor luchtinlaat)
- Straalpijstool met trekker bediening



CE

TECHNISCHE DATA

Bruikbare afmetingen van de cabine: 600x520x320 mm
Buiten afmetingen: 660x530x500 mm
Gewicht: 38 kg
Werkblad: geperforeerd stalen blad
Verlichting: LED Luchtverbruik: 340 l/min bij 7 atm
Voeding: 220 V - 50 Hz

1897	€	3.440,00	1	018970066
------	---	----------	---	-----------

1897/CRB

Corund straalgrit voor straalcabine 1897 in 25 kg zak



1897CRB	€	180,50	1	018970101
---------	---	--------	---	-----------

1897/G

Granulaat grit voor straalcabine 1897 in 25 kg zak



1897G	€	144,50	1	018970104
-------	---	--------	---	-----------

1897/MV

Glasparel straalgrit voor straalcabine 1897 in 25 kg zak



1897MV	€	237,00	1	018970103
--------	---	--------	---	-----------

1898/K40

Reinigingstank voor het handmatig
schoonmaken van onderdelen door middel
van

verwarmde vloeistof en regeneratie door
micro-organismen

- Elimineert de kosten van het afvoeren van oplosmiddelen of koolwaterstoffen
- Door Beta's ecologische wasmiddel op basis van enzymen en bacteriën te gebruiken, kunnen olieresten van mechanische onderdelen worden verwijderd en afgevoerd
- Enzymatische functie helpt het olieachtige deel van het vuile vaste deel te scheiden; bacteriën transformeren een dergelijk onderdeel in kooldioxide en water, waardoor het wasmiddel blijft regenereren.



CE

UITRUSTING:

- Lange borstel en verbindingspijp
 - Rechter en linkerhand aansluiting
 - Geperforeerd roestvaststalen rooster
 - Wielen met remmen
 - Display met weergave van bedrijfstemperatuur en laag alarm
- MEEGELEVERDE TOEBEHOREN:**
- 2 blikken van 20 l milieuvriendelijk vloeibaar wasmiddel en 2 pakken bacteriën

TECHNISCHE DATA

- Max. pompcapaciteit: 10 ltr / min
- Tankinhoud: 40 ltr
- Bedrijfstemperatuur: +5 °C ÷ +40 °C
- Afmetingen: 900 x 1000 x 750 mm
- Gewicht: 50 kg (indien leeg)

1898/K40	€	4.590,00	1	018980004
----------	---	----------	---	-----------

ATTENTIE

Landen waar product 1898 / K40 mag worden gedistribueerd zijn: Oostenrijk, België, Frankrijk (vanaf 2021), Hongarije, Italië, Nederland, Polen, Portugal, Spanje, Verenigd Koninkrijk.

1898/B

flesmet bacteriën, 300 ml
voor reinigingstank 1898/K40



1898/B	€	94,50	1	018980904
--------	---	-------	---	-----------

LET OP:

Landen waar item 1898/B mag worden gedistribueerd: Oostenrijk, België, Frankrijk, Italië, Nederland, Polen, Portugal, Verenigd Koninkrijk, Spanje, Hongarije

1898/D

Flacon met milieuvriendelijke reinigingsvloeistof, 20L voor onderdelenreinigingstank 1898/K40



1898/D € 187,00 1 018980920

LET OP:

Landen waar item 1898/D mag worden gedistribueerd: Oostenrijk, België, Frankrijk, Italië, Nederland, Polen, Portugal, Verenigd Koninkrijk, Spanje, Hongarije

1898/M

drukspuit met 1,5 liter tank

- verstelbaar mondstuk met rechte straal en nevelspray
- schaalverdeling 0,5 l - 1 l - 1,5 l
- vergrendelingshendel voor continue straal
- niet voor gebruik met koolwaterstoffen



H mm 340 l 1,5 € 17,00 1 018980930

1898/S

handdrukpomp met 5 l tank

- roestvrijstalen mondstuk
- vergrendelingshendel voor continue straal
- verstelbare sproeikop met rechte straal en nevelspray
- schouderriem voor gemakkelijk transport
- handgreep voor het aansluiten van mondstukken
- 1,2 m lange slang
- niet voor gebruik met koolwaterstoffen



H mm 415 l 5 € 29,00 1 018980932



1899A

DPF/FAP®-systeemreinigingsmachine

Speciale reinigingsmiddelen kunnen periodiek worden gebruikt om DPF- en FAP®-systemen te reinigen en ontdoen van roet- en asafzettingen



voorzien van:

- 1 2 m lange toevoerleiding
- 1 snelkoppeling + slangmondstuk voor verschilsensorslangen
- 1 Niplex M18x1.5 met slangtule voor directe aansluiting op lambdasonde
- 1 verlengslang
- 1 DPF/FAP®-sproeikop
- 1 magnetische leidingsteun
- 1 DPF/FAP® buis met afstelkabelwartel plus niplex M14/16/18 mm voor het aansluiten van lambdasondes

Technische specificaties:

- bedrijfsspanning: 12 V
- lengte voedingskabel: 3,9 m
- tankinhoud: 1 l

1899A € 1.320,00 1 018990010

1899SI

2-in-1-machine voor het reinigen van injectoren en inlaatspruitstuk

speciale reinigingsmiddelen kunnen worden gebruikt om de injectoren en het inlaatspruitstuk bij diesel- en benzinemotoren periodiek te reinigen, waarbij koolstofhoudende afzettingen en verbrandingsresten worden verwijderd



Specificaties:

- Bedrijfsspanning: 12 v
- 2 Service-slangen met snelkoppelingen
- 2 tanks (capaciteit: 1 l elk)

1899SI € 4.870,00 1 018990030

2080/VG

Koffer-organizer met uitneembare assortimentsdoosjes

- Met bovenin opbergruimte voor kleine onderdelen (145 mm in diameter) en 4 plateaus:
- 1 plateau met een diameter van 305 mm
- 3 plateaus met een diameter van 445 mm
- Geleverd compleet met 12 tussenschotten voor gebruik in de 3 grotere draaiplateaus, om tot 8 compartimenten per niveau te komen.



2080/VG € 199,50 1 020800100
445x445x550 mm - 3,4 kg

2250-0

Robuuste verrijdbare zitkruk met gereedschapshouder



2250-0 € 114,50 1 022500011

2252

Zitkruk op wielen



2252-G € 183,00 1 022520002

2252KR4

Reserve wielen voor kruk 2252



2252KR4 € 63,50 1 022520900

2258N-0

Heavy-duty zitkruk met gereedschapsladen



2258N-0	€ 195,00	1	022580021
---------	----------	---	-----------

2258RR

Reservewiel voor heavy-duty zitkruk 2258N



2258RR	€ 12,50	1	022580111
--------	---------	---	-----------

2254A

autohoezen, voor buiten, waterafstotend en uv-bestendig

Deze hoezen zijn ideaal om beschadigde voertuigen te beschermen terwijl ze wachten op reparatie

Technische specificaties

- buitenafwerking met UV-beschermende coating
- zachte, krasvaste binnenafwerking
- 6 verstelbare koorden om de hoes goed aan te laten sluiten op de auto.
- 2 ritsen in de voorportieren om toegang te krijgen tot het voertuig zonder de hoes te verwijderen
- uitsparingen voor de spiegels
- reflecterend



3 Maten:

- maat M aanbevolen voor compacte auto's
- maat L aanbevolen voor sedanwagens en stationwagens
- maat XL aanbevolen voor SUV's

	LxPxH mm	€		
/M	4400x1450x1300	161,00	1	022540002
/L	5300x1450x1150	180,00	1	022540000
/X	4700x1450x1580	165,00	1	022540001

2254C

Carosserie beschermer met zuignappen

Vervaardigd uit geplastificeerd textiel, met 4 zuignappen achterzijde



2254C	L1 mm	L2 mm	€		
	1150	650	54,00	1	022540200

2254F

Frontbeschermer

Beschemt de voorzijde van het voertuig en heeft uitsparingen voor koplampen en radiator.



- Waterafstotend
- Bestand tegen olie en vet
- Bevestiging door spanbandje
- Materiaal: 98% polyamide/nylon, 2% polyurethaan

2254F	€		
	89,00	1	022540150

2254K

Herbruikbare stoel, stuur en versnellingspook beschermhoes

Geschikt voor meeste auto's, sturen en versnellingspoken



2254K	€		
	31,00	1	022540101

2254SM

Ligmat, vervaardigd uit EVA foam

Dubbele afwerking:

- 1 zijde in zacht EVA foam
- 1 zijde in harde carbon look voor een verbeterde anti slip



2254SM	€		
	69,50	1	022540033

2254T

Knie beschermmat

Vervaardigd uit anti-slip EVA foam



2254T	€		
	30,50	1	022540047

3000L

Montagebed

- Met PVC afgewerkte rubber met voor opmerkelijk comfort.



3000L	€		
	176,50	1	030000210

3000L/RLS

Reserve wielen voor montagebed



3000L/RLS	€		
	12,90	6	030000212

3002

Verrijdbare ligmaat en zitkruk

- Stalen constructie
- PVC voering en bekleding
- Eenvoudig om te bouwen van ligmaat naar zitkruk



3002 € 114,00 1 030020001

3002/RLS

6 reserve wielen voor ligmaat artikel 3002



3002/RLS € 31,50 1 030020501

3003

Verrijdbare ligmaat
Vervaardigd uit schokbestendige kunststof

- Wielen Ø: 76 mm



3003 € 91,00 1 030030001

3003/RLS

6 reserve wielen voor ligmaat artikel 3003



3003/RLS € 50,00 1 030030501

Beta

3003C

Verrijdbare ligmaat, vervaardigd uit schokbestendig kunststof

- Compleet met:
- Hoofd en rugdeelte afgewerkt in carbon look
 - Metalen inzetstukken voor het bevestigen van magnetische accessoires
 - 6 rubberen wielen, 79 mm in diameter
 - Max. capaciteit: 120 kg
 - Gewicht: 5.5 kg



3003C € 241,50 1 030030100

3003C/RLS

6 reserve wielen voor verrijdbare ligmaat 3003C



3003C/RLS € 100,50 1 030030600

3003PRO

Verrijdbare ligmaat, vervaardigd uit schokbestendig kunststof

Compleet met:

- Ergonomisch gevormde hoofdsteun
- Zachte rugbescherming
- 2 178 mm dubbel kogelgelagerde wielen voor een probleemloos gebruik op oneffen vloeren of over pijpen/kabels
- 1 centraal zwenkwiel
- Dubbele hoogte instelling van de grond: 38 of 76 mm
- 2 afneembare LED lampen (250 lumen) met bevestigingsmagneten
- Maximale capaciteit: 200 kg
- Gewicht: 7.7 kg



C max	H min	H Max	H1	€	1	030030150
kg	mm	mm	mm			
200	170	230	230	359,00	1	030030150

3003PRO/SP

Kunststof ophangbeugel voor ligmaat 3003PRO

Is te monteren aan muren, bruggen, ladekasten of gereedschapswagens, waardoor de ligmaat snel opgehangen kan worden en voorzien is van een veiligheidssluiting.



3003PRO/SP € 91,50 1 030030151

3003PRO/PM

Magnetische gereedschapshouder rond, voor verrijdbare ligmaat artikel 3003PRO

Kan worden toegepast op de velgen van de verrijdbare ligmaat om kleine delen vast te houden tijdens werkzaamheden



3003PRO/PM € 9,75 1 030030152

3003PRO/RCR

Reserve wielen voor verrijdbare ligmaat 3003PRO, paar



3003PRO/RCR € 75,00 1 030030650

Beta

3003PRO/RRG

Reserve voor wiel voor verrijdbare ligmat 3003PRO



3003PRO/RRG € 22,50 1 030030651

3003PRO/RT

LED inspectie lamp met reserve magneten voor verrijdbare ligmat 3003PRO

- 250 lumen
- Batterijen: 4xAAA (niet meegeleverd)



3003PRO/RT € 16,60 1 030030652

3004

wielstop wig



3004 H mm 225 L mm 475 L1 mm 200 € 34,50 1 030040000

VOERTUIG REPARATIE

Onze reparatie gereedschappen voor voertuigen, die worden gebruikt door de meest veeleisende professionals, zijn ontwikkeld en vervaardigd om te voldoen aan de hoogste normen ter wereld en worden regelmatig getest onder de meest stressvolle bedrijfsomstandigheden.

Al meer dan 50 jaar werken we met trots samen met de grootste kampioenen, die ons non-stop helpen onze producten te verbeteren en te bewijzen volgens de hoogste kwaliteitsnorm.

De voertuig reparatie gereedschappen zijn te vinden in deze secties:

Diagnose	artikel 1438 tot 1499 artikel 1758VT tot 1760TMC
Mototr	artikel 955 tot 989A artikel 1438 tot 1499
Olie en filters	artikel 1438 tot 1499 artikel 1877 tot 1885
Elektrisch systeem	artikel 1438 tot 1499
Startboosters	artikel 1498BC/12 tot 1498/40A
Versnelling	artikel 1438 tot 1499
Ophanging	artikel 1549 tot 1569CP
Remmen	artikel 1438 tot 1499
Wielen	artikel 955 tot 989A
Carrosserie gereedschap	artikel 1302 tot 1369 artikel 1763 tot 1767A
Overig gereedschap	artikel 1875LT tot 3067
Garagekriks	artikel 3029/2T tot 3067/70-13T



3006

Krik en wielmontage apparaat voor tractor en grondverzet wielen

- max. capaciteit: 1,500 kg
- min. wiel diameter: 1,000 mm
- max. wiel diameter: 2,200 mm
- max. wiel breedte 800 mm

CE



3006 € 1.930,00 1 030060000

3006 R/RGF

Reserve wiel met rem voor krik en wielmontage apparaat 3006



3006 R/RGF € 75,50 1 030060501

3006 R/RG

Reserve wiel voor krik en wielmontage apparaat 3006



3006 R/RG € 65,50 1 030060502

3007

Voertuigverplaatser waarbij de voor of achteras ontbreekt

Maakt het mogelijk voertuigen, waarvan de voor of achteras ontbreekt, te verplaatsen voor werkzaamheden

- 4 zwenkwielen, waarvan 2 met rem, geschikt voor het gebruik in spuitcabines
- 2 verstelbare steunen passend op alle chassis
- Max. capaciteit: 800 kg

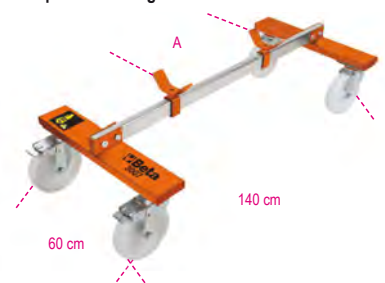

3007 A Max mm 110 € 674,00 1 030070001

Beta

3007 R/RGF

Reserve wiel met rem voor voertuigverplaatser 3007



3007 R/RGF € 118,00 1 030070501

3007 R/RG

Reserve wiel voor voertuigverplaatser 3007



3007 R/RG € 103,50 1 030070502

3008N

Krik en bandenplaatser voor enkel en dubbel lucht vrachtwagen wielen

- maximale capaciteit: 500 kg
- minimale hoogte: 120 mm
- maximale hoogte: 650 mm
- afstand tussen rollen: 429+670 mm
- hydraulisch veiligheidssysteem in geval van overbelasting
- zwenkwielen voor

CE



3008N € 3.070,00 1 030080110

3009

Voertuigverplaatser

Maximale hef capaciteit: 550 kg
4 zwenkbare wielen
Rolbreedte: 200 mm
Voor banden tot 240 mm breed



A 400÷850 mm B 600 mm € 451,00 1 030090001

3009R/GR4

4-delig set wielen voor artikel 3009



3009R/GR4 € 190,00 1 030090501

3010/T...

Assteunen, per paar



C max kg	H min mm	H max mm	H1 mm	L mm	L1 mm
2000	280	425	245	185	165

3010T 2 € 108,50 1 030100002

C max kg	H min mm	H max mm	H1 mm	L mm	L1 mm
3000	285	430	250	180	195

3010T 3 € 130,00 1 030100003

C max kg	H min mm	H max mm	H1 mm	L mm	L1 mm
6000	400	580	340	245	280

3010T 6 € 188,50 1 030100006

C max kg	H min mm	H max mm	H1 mm	L mm	L1 mm
10000	471	735	420	330	290

3010T 10 € 315,00 1 030100010

3011/T

Hydraulische potcricks

CE



C max kg	H min mm	H Max mm	L mm
2000	174	369	90

3011T 2 € 125,00 1 030110020

C max kg	H min mm	H Max mm	L mm
3500	170	366	86

3011T 3,5 € 106,00 1 030110035

C max kg	H min mm	H Max mm	L mm
5000	203	467	118

3011T 5 € 119,00 1 030110050

C max kg	H min mm	H Max mm	L mm
10000	220	484	114

3011T 10 € 180,50 1 030110100

C max kg	H min mm	H Max mm	L mm
15000	230	497	113

3011T 15 € 223,50 1 030110150

C max kg	H min mm	H Max mm	L mm
20.000	245	521	115

3011T 20 € 319,00 1 030110200

3010H

Zware assteunen



C Max kg	H min mm	H Max mm	L mm	L1 mm
15.000	445	631	300	300

3010H631-T15 € 358,00 1 030100150

C Max kg	H min mm	H Max mm	L mm	L1 mm
15.000	645	1077	300	300

3010H1077-T15 € 440,00 1 030100165

3010V

Zware assteunen, uitdraaibare spindel



C Max kg	H min mm	H Max mm	L mm	L1 mm
20.000	410	600	330	330

3010V600-T20 € 505,00 1 030100200

C Max kg	H min mm	H max mm	L mm	L1 mm
20.000	665	1090	460	460

3010V1090-T20 € 642,00 1 030100220

3012

Motorensteun



L mm	C max kg	€		
1500	500	326,00	1	030120010
1800	400	453,00	1	030120018

3012C

Motorensteun

Ideaal voor auto's en bedrijfsvoertuigen



	€		
3012C	869,00	1	030120255

3012I

Motorensteun

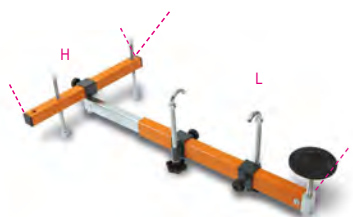

L mm	H mm	€		
3012I	630+960	190	770,00	1 030120250

3014

Motorenstandaard



	€		
3014	434,00	1	030140010

3014R/GR5

5 reserve wielen voor motorensteun artikel 3014



	€		
3014R/GR5	105,00	1	030140501

3014 SAR

Inklapbare motorensteun

- Eenvoudig in te klappen, waardoor aanzienlijk ruimte besparend
 - Maakt het mogelijk de motor 360° te draaien
 - Garandeert ongelijke veiligheid en stabiliteit tijdens werkzaamheden
- Maximale capaciteit: 450 kg



	€		
3014SAR	1.525,00	1	030140360

3014SAR/RR

4 reserve wielen voor motorensteun artikel 3014SAR



	€		
3014SAR/RR	172,50	1	030140370

3014SAR/1

Vloeistofopvangbak voor artikel 3014 SAR

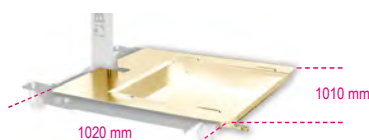

	€		
3014SAR/1	454,00	1	030140361
1020x1010x11 mm			

3014SAR/2

Klem voor het fixeren van de versnellingsbak op artikel 3014 SAR

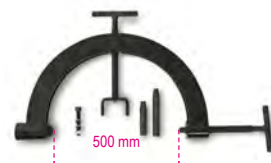

	€		
3014SAR/2	437,00	1	030140362

3023

Hulpsteun voor onder de brug met schroef verstelling

Maximale draagcapaciteit: 400 kg



	H min-Max mm	Ø mm	€		
3023	1350+2030	300	235,00	1	030230050

3025N

Inklapbare hydraulische kraan met dubbelwerkende pomp

Specificaties:

- Maximale capaciteit: 1 t
- 4 hefposities: 300-600-800-1000 kg
- Met veiligheidsklep tegen overbelasting en verchroomde plunjer
- Gecontroleerde daalsnelheid
- Nylon wielen
- Maximale hoogte: 2420 mm



A mm	B mm	C mm	D mm	€		
1560	1600	1000	880	1.915,00	1	030250110

3025N/PF

Vatenklem

Maximale capaciteit: 300 kg

CE



	A mm	B mm	€		
3025N/PF	550+640	70	483,00	1	030250111

3026 0,3

Hydraulische transmissiekrik

CE



H min mm	H Max mm	L mm	L1 mm	Ø mm	€		
1120	1970	450	450	25	747,00	1	030260003

3026/R0,3

4 reserve zwenkwieien voor hydraulische krik 3026 0,3



	€		
3026/R 0,3	198,00	1	030260903

3026 0,5

Hydraulische transmissiekrik

Maximale capaciteit: 500 kg

CE



H min mm	H Max mm	L mm	L1 mm	Ø mm	€		
1140	1990	600	550	30	892,00	1	030260005

3026/R0,5

4 reserve zwenkwieien voor hydraulische krik 3026 0,5



	€		
3026/R 0,5	268,00	1	030260905

3026 1,0

Hydraulische transmissiekrik

Maximale capaciteit: 1 t

CE



H min mm	H Max mm	L mm	L1 mm	Ø mm	€		
1140	1990	650	550	35	1.083,00	1	030260010

3026/R 1,0

4 reserve zwenkwieien voor hydraulische krik artikel 3026 1,0



	€		
3026/R 1,0	392,00	1	030260910

3026/S

Kantelbare transmissie steun met verloopbussen voor de krik artikel 3026

Maximale capaciteit: 500 kg

CE



	€		
3026/S	627,00	1	030260501

3026/SP

Universele transmissie steun

Maakt het voor een monteur mogelijk om veilig en snel versnellingsbakken te monteren en te demonteren van auto's, bedrijfsvoertuigen en "off the road" voertuigen.

CE



	€		
3026/SP	736,00	1	030260505

3026/SA

Wielnaaf steun voor transmissiekrik

- Te gebruiken bij onderhoudswerkzaamheden met betrekking tot navens en het vervangen van schokdempers
- Passend op de hydraulische transmissiekrikken artikel 3026 0,3 en 3026 0,5



	Ø mm	€		
3026/SA	30,4	153,50	1	030260510

3026/SAM

Schokdemper steun voor transmissiekriks

- Voor gebruik ter ondersteuning van schokdempers wanneer de draagarm is verwijderd
- Schokdemperplaat, max. diameter 80 mm, plus adapter voor max. diameters 60 mm
- Passend op de hydraulische transmissiekrikken, artikel 3026 0,3 en 3026 0,5



	€		
3026/SAM	199,50	1	030260515

3027N 10

Hydraulische werkplaatspers met verschuifbare perscilinder

- Maximale capaciteit: 10 t
- Manuele pomp met 2 versnellingen
- Verschuifbare cilinder
- Automatische terugtrekken van de plunjer
- Set van V-vormige prisma's inbegrepen
- verchromde stand

CE



3027N 10 € 1.920,00 1 030270101

3027N 20

Hydraulische werkplaatspers met verschuifbare perscilinder

- Maximale capaciteit: 20 t
- Manuele pomp met 2 versnellingen
- Verschuifbare cilinder
- verchromde plunjer
- Automatische terugtrekken van de plunjer
- Hydraulisch veiligheidssysteem in geval van overbelasting
- Manometer
- Set van V-blokken inbegrepen

CE



3027N 20 € 2.560,00 1 030270102

3027N 30

Hydraulische werkplaatspers met verschuifbare perscilinder en takel

- Maximale capaciteit: 30 t
- Manuele pomp met 2 versnellingen
- Verschuifbare cilinder
- verchromde stand
- Automatische terugtrekken van de plunjer
- Hydraulisch veiligheidssysteem in geval van overbelasting
- Manometer
- Set van V-blokken inbegrepen
- Takel van staalkabel voor het tillen van werkblad

CE



3027N 30 € 4.640,00 1 030270103

3027N 50

Hydraulische pers met bewegende zuiger en takel

- Maximale capaciteit: 50 t
- Manuele pomp met 2 versnellingen
- Verschuifbare cilinder
- verchromde stand
- Automatische terugtrekken van de plunjer
- Hydraulisch veiligheidssysteem in geval van overbelasting
- Manometer
- Set van V-blokken inbegrepen
- Takel van staalkabel voor het tillen van werkblad

CE



3027N 50 € 6.400,00 1 030270105

3027N 100

Gemotoriseerde elektro-hydraulische pers met verschuifbare perscilinder en takel

- Maximale capaciteit: 100 t
- Voeding 230-400V (drie fase)
- Frequentie: 50 Hz
- Elektrische motorvermogen: 3 kW
- Elektro-hydraulische pomp met twee versnellingen
- Bediening met hendelverdelers in 3 standen: vooruit-neutraal-terug
- Verschuifbare cilinder
- cilinder Ø: 100 mm
- Werktafel heffen door middel kettingen
- voedingskabel met 4-polige industriële stekker (380V)
- Motorolie inbegrepen

CE



3027N 100 € 21.280,00 1 030270110

3027N/KP

set persstukken en plaat voor pers 3027N



		€		
3027N/KP10-20	3027N10-20	395,00	1	030270511
3027N/KP30	3027N 30	540,00	1	030270531
3027N/KP50	3027N 50	638,00	1	030270541
3027N/KP100	3027N 100	995,00	1	030270552

3027N/KPP

Voetpedaal bediening voor hydraulische pers 3027N



		€		
3027N/KPP10		375,00	1	030270560
3027N/KPP50		430,00	1	030270565

Beta

3027/PR

Pers ondersteunende hulpstuk voor het verwijderen of plaatsen van naven, lagers en silentblokken

Universeel systeem maakt het mogelijk om naven, lagers en silentblokken in of uit te persen uit hun behuizing met behulp van een pers. Het hulpstuk dient als basis met hulpstukken. Het hulpstuk positioneert zich aan de onregelmatige geometrische vormen van naven, kegels waarop gewerkt moet worden.



TECHNISCHE DATA

Werk bereik: min. 130 mm - max. 186 mm
Afmetingen: 300 x 300 mm
Gewicht: 13 kg
Max. belasting capaciteit: 20 t

3027/PR € 679,00 1 030270400

3028 15

Hydraulische werkplaatspers met verschuifbare perscilinder

Maximale capaciteit: 15 t
Verticale topaanpassing
verschuifbare perscilinder



A mm B mm C mm D mm
1010 565 480 80+370 € 1.071,00 1 030280015

3028SP/15

Protectiescherm voor pers 3028 15



3028SP/15 € 151,50 1 030280016

3028 20

Hydraulische werkplaatspers met verschuifbare perscilinder

Maximale capaciteit: 20 t
Verschuifbare perscilinder

CE

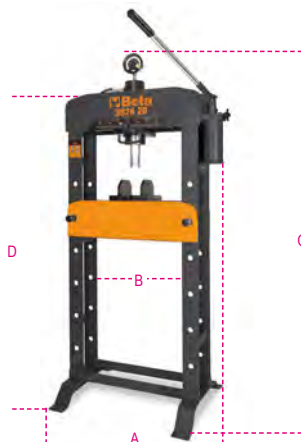

A mm B mm C mm D mm
850 540 1830 1602 € 1.615,00 1 030280020

3028SP/20

protectiescherm voor persen 3028 20



3028SP/20 € 180,50 1 030280021

3028 30

Hydraulische werkplaatspers met verschuifbare perscilinder

Maximale capaciteit: 30 t
Verschuifbare perscilinder

CE

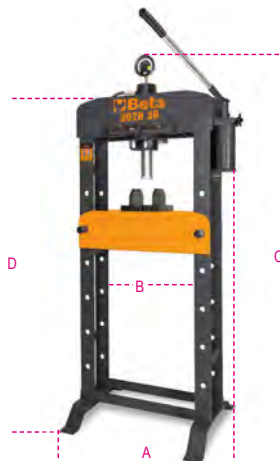

A mm B mm C mm D mm
850 540 1850 1650 € 2.255,00 1 030280030

3028SP/30

protectiescherm voor persen 3028 30



3028SP/30 € 180,50 1 030280031

3028 50

Hydraulische werkplaatspers met verschuifbare perscilinder

Maximale capaciteit: 50 t
Verschuifbare perscilinder

CE

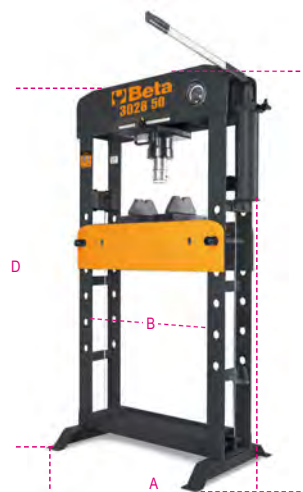

A mm B mm C mm E mm
1100 750 1850 820 € 3.960,00 1 030280050

3028SP/50

protectiescherm voor persen 3028 50



3028SP/50 € 191,00 1 030280051

3028/KP

set persstukken en plaat voor pers 3028



3028/KP € 150,00 1 030280055



3029/2T

Lage hydraulische garagekrik, 2 tons met 4 wielen

- Snel liften door voetpedaal
- Stalen constructie en nylon wielen
- Minimum hoogte: 75 mm

CE



3029/2T € 449,00 1 030290020

3029L/2T

Lange en lage hydraulische garagekrik, 2 ton

Maakt het mogelijk om voertuigen te heffen welke een kleine ruimte hebben tussen de grond en het hefpoint

- Gecontroleerde daalsnelheid
- Snel liften door voetpedaal
- Nylon wielen

CE



3029L/2T € 515,00 1 030290120

3029/2T-L/RP

Reserve 85-mm rubber schoteldop voor artikelen 3029/2T en 3029L/2T



3029/2T-L/RP € 17,00 1 030290502

3029/2T-L/R6

reserve wiel voor artikelen 3029/2T, 3029L/2T, 3030H/2T, 3033E/3T"



3029/2T-L/R6 € 57,00 1 030290506

3029/2T-L/R5

Reserve voorste wiel voor kriks artikel 3029/2T en artikel 3029L/2T



3029/2T-L/R5 € 52,00 1 030290505

3030/2T

Verlaagde hydraulische werkplaatskrik 2 ton met 6 wielen.

- Dubbele kantelbare wielen aan voorzijde vervaardigd uit kunststof materiaal (PTFE)
- De krik is eenvoudige te verrijden, zelfs op oneffen en hobbelige vloeren
- maximale capaciteit: 2 tons

CE



3030/2T € 860,00 1 030300020

43 kg

3030/2T-R5

Voorwiel met borgpin voor werkplaatskrik artikel 3030 2T



3030 2T/R5 € 31,50 1 030300505

3030/2T-R6

Reserve achter wiel voor artikel 3030/2T



3030 2T/R6 € 47,50 1 030300506

3030/2TRP

Reserve 85-mm rubber schoteldop voor item 3030/2T



3030/2TRP € 5,90 5 030300501

3030H/2T

Hydraulische werkplaatskrik, grote lichthoogte, 2 t, met 6 wielen

Maakt het mogelijk te werken aan voertuigen die hoog van de grond zijn en lange schokdempers hebben. • Gecontroleerde daalsnelheid

- Snel liften door voetpedaal
- Nylon wielen

CE



H min-Max mm 85-780 L mm 1010 L1 mm 300 € 724,00 1 030300220

3033/3T

Hydraulische garage krik, 3t lange uitvoering

- Geschikt voor het gebruik op bedrijfsvoertuigen
- Maximale capaciteit: 3 t
- Polyamide wielen

CE



3033/3T € 1.137,00 1 030330030



3033E/3T

Hydraulische krik,
3 ton

- Gecontroleerde daalsnelheid
- Nylon wielen

CE



	H min-Max mm	L mm	L1 mm	€		
3033E/3T	95+515	700	370	435,00	1	030330130

3033S 3T/R2

wiel voorzijde krik 3033E/3T"



3033S 3T/R2	€		
	51,00	1	030330532

Beta

3035

Bandenwagen

- 2 wielen Ø 260 mm
- 2 wielen Ø 125 mm
- Maximale transport hoogte: 1.60 m
- Maximale draag vermogen: 200 kg
- De vorken kunnen ingesteld worden in 2 posities:
eerste positie: maximale opening 880 mm
tweede positie: maximale opening 980 mm



3035	€		
	1.043,00	1	030350100

3036

Wiel en banden transporter

Streepvrije wielen



3036	€		
	124,50	1	030360063

3061/2T

Luchtkrik, 2 ton - 2 traps

CE



B	415 mm
C	250 mm
D	132-326 mm
E	2 t

Voorzien van:

- Robuust drielaags middenrif en interne telescopische spindel
- Automatische eindstop en veiligheidsklep tegen overbelasting
- Kan tevens gebruikt worden op een werkplaatsbrug

TECHNISCHE SPECIFICATIES

Capaciteit: 2 t
Gewicht: 14 kg
Werkdruk: 8-10 bar
Hoogte: min.132 - max. 326 mm

3061/2T	€		
	958,00	1	030610020

3061/2T-P50

50-mm verlengstuk voor model 3061/2T



3061/2T P50	€		
	83,50	1	030610021

3061/2T-P100

100-mm verlengstuk voor model 3061/2T



3061/2T P100	€		
	108,50	1	030610022

Beta

Beta

3065/20-10T

Lucht hydraulische krik, 20-10 t, met koffer

Dragbaar en lichtgewicht, ideaal voor mobiele hulp werkzaamheden

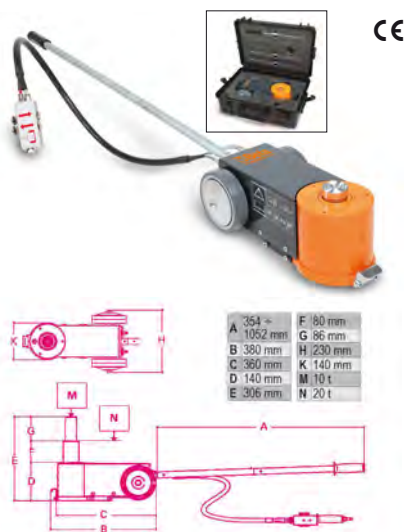

• Geleverd met twee verlengstukken, 75 en 60 mm hoog

TECHNISCHE GEGEVENS

Capaciteit: 20-10 t

Gewicht: 23 kg

Benodigde werkdruk: 8-10 bar

Luchtverbruik: 400 nl/min

3065/20-10T € 2.850,00 1 030650100

3065/40-20T

Lucht hydraulische krik, 40/20 ton

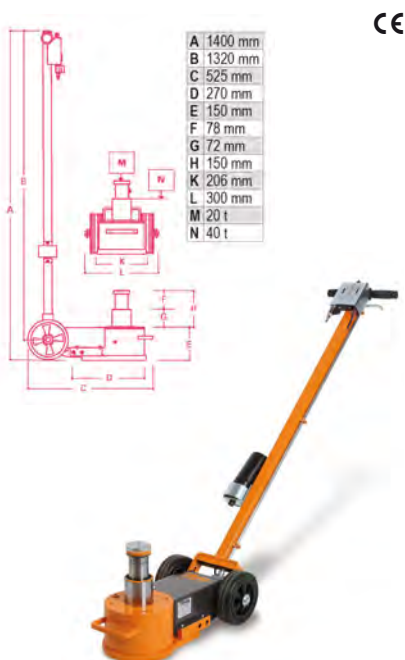

- Geschikt voor het gebruik op zware voertuigen
- Functioneel en eenvoudig in gebruik, tevens inzetbaar door mobiele service diensten
- Automatisch zakken van de plunjer naar begin positie
- Twee kleppen zorgen voor het gecontroleerd zakken

TECHNISCHE SPECIFICATIES

Capaciteit: 40/20 ton

Gewicht: 39 kg

Werkdruk: 8-10 bar

Luchtverbruik: 400 l/min

3065/40-20T € 3.230,00 1 030650200

3067/60-15T

Lucht hydraulische krik, 60-30-15 t

Met een minimale hoogte van niet meer dan 120mm, is uitermate geschikt voor het gebruik bij bussen, touringcars en algemene transportvoertuigen.



- Plunjer zakt automatisch terug in beginstand
- Twee kleppen voor gecontroleerd dalen onder belasting
- Geleverd met twee verlengstukken, 70 en 120 mm hoog

TECHNISCHE GEGEVENS

Capaciteit: 60-30-15 t

Gewicht: 56 kg

Benodigde werkdruk: 8-10 bar

Lucht verbruik: 600 l/min

3067/60-15T € 4.740,00 1 030670120

3067/70-13T

Lucht hydraulische krik, 70-43-23-13 t

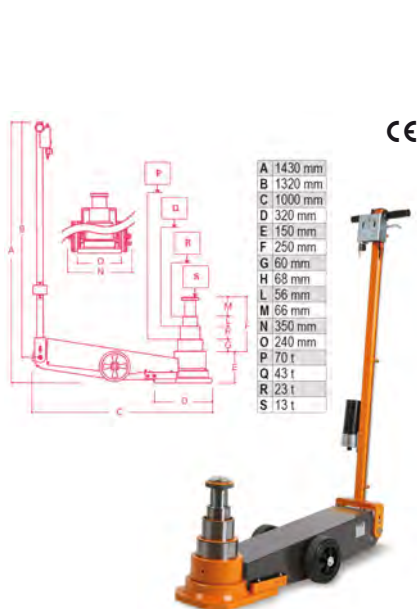

Lange uitvoering, geschikt voor het gebruik op aanhangwagens, uitzonderlijke voertuigen, bussen, toerwagens en agrarische voertuigen

- Automatisch zakken van de plunjer naar de beginpositie
- Twee kleppen zorgen voor het gecontroleerd laten zakken

TECHNISCHE SPECIFICATIE

Capaciteit: 70-43-23-13 tons

Gewicht: 74 kg

Werkdruk: 8-10 bar

Luchtverbruik: 600 l/min

3067/70-13T € 5.920,00 1 030670130

3068

Palletwagen met lage lepel



Technische data:

- maximale capaciteit: 2500 kg
- totale lengte: 1200 mm
- vorklengte: 800 mm
- vorkbreedte: 540 mm
- individuele vorkbreedte: 160 mm
- hefboomhoogte: 1230 mm
- max. hefhoogte: 115 mm

3068 € 799,00 1 030680000

3069

Palletwagen



Technische data:

- maximale capaciteit: 2500 kg
- totale lengte: 1550 mm
- vorklengte: 1150 mm
- vorkbreedte: 540 mm
- individuele vorkbreedte: 160 mm
- hefboomhoogte: 1230 mm
- max. hefhoogte: 115 mm
- pallettopslagang: 800x1200 lengte: 1805 mm
- draaicirkel: 1347 mm

3069 € 749,00 1 030690000



MOTORFIETS GEREEDSCHAP

Beta's reparatiegereedschappen voor motoren omvat speciaal ontworpen producten voor de motorfietsindustrie. Onze producten worden regelmatig bijgewerkt.

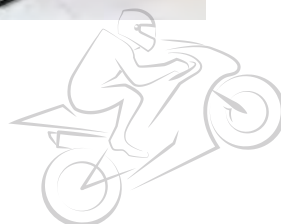

3040C

Motorenstandaard, achter, verstelbaar

- Mat zwart gelakt
- 4 thermoplastische rubber wielen
- Inclusief V-vorm adapters, paar
- Inclusief L-vorm adapters, paar



3040C

€ 93,50

1 030400002

3040C/S1

V-vorm adapters, paar, voor artikel 3040C



3040C/S1

€ 14,30

1 030400503

3040C/S2

Rubber L-vorm adapters, paar, voor artikel 3040C



3040C/S2

€ 19,70

1 030400504

3041C

Motorenstandaard, voor, verstelbaar

- Mat zwart gelakt
- 4 thermoplastische rubber wielen
- Inclusief rol adapters, paar
- Inclusief kegelvormige adapters, paar



3041C

€ 84,00

1 030410002

3041C/12

Rol adapters, paar, voor artikel 3041C



3041C/12

€ 19,70

1 030410512

3041C/16

Kegelvormige adapters,
voor artikel 3041C



3041C/16	€ 13,20	1	030410516
----------	---------	---	-----------

3042C

Motorenstandaard passend op
de voorvork

- Mat zwart gelakt
- 4 thermoplastische rubber wielen
- Inclusief 8-pins kit Ø 13 - 15 - 15.5 - 17 - 19 - 20 - 21 - 27



3042C	€ 148,50	1	030420002
-------	----------	---	-----------

3043C

Motorenstandaard
met enkelzijdige links ophang

- Mat zwart gelakt
- 4 thermoplastische rubber wielen
- Pin facultatief



3043C	€ 110,00	1	030430002
-------	----------	---	-----------

3043C/ 41÷47

Pin
voor item 3043C



	Ø mm	€		
3043C/41 Ducati	21,5 ÷ 25,5	24,80	1	030430551
3043C/42 KTM - Triumph	27,5	24,80	1	030430552
3043C/43 MV	42,5	27,50	1	030430553
3043C/44 Ducati	40,5	27,50	1	030430554
3043C/45 Honda	28,5	25,00	1	030430555
3043C/47 BMW	53,5	32,00	1	030430557

3047C

Motorbok voor
cross/enduro motorfietsen



3047C	€ 69,50	1	030470002
-------	---------	---	-----------

3048C

Staal motorbok voor racing crossmotor

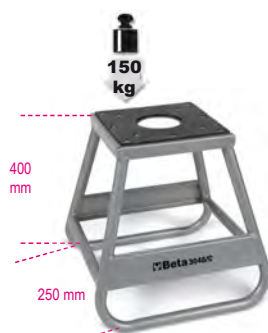

3048C	€ 69,50	1	030480002
-------	---------	---	-----------

3050/CC

Verstelbare motorbok voor
Custom, Enduro, Cross, Scooter motorfietsen



Inclusief een instelbare ondersteuningset



3050/CC	€ 171,00	1	030500012
---------	----------	---	-----------

3050/600

Elektrische aangedreven hydraulischhefbrug,
600 kg



CE

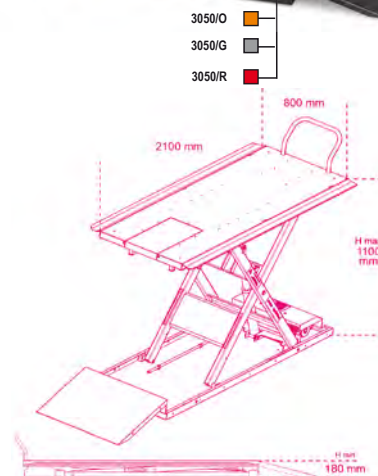

Technische kenmerken

- Electrisch, mechanisch en hydraulische beveiliging
- Capaciteit: 600 kg
- Geïntegreerde elektro-hydraulische aandrijving: 230V - 50 Hz
- Hydraulische pomp
- Gecontroleerde daalsnelheid
- Veiligheidszekeringen voor bescherming bij kabelbreuk
- Bedieningspaneel met drukknopen
- CE-certificaat, TÜV-goedgekeurd

	L	L	H min	H Max	€		
	mm	mm	mm	mm			
3050/O	975	2100	185	1110	6.000,00	1	030500201
3050/G	975	2100	185	1110	6.000,00	1	030500202
3050/R	975	2100	185	1110	6.000,00	1	030500203

3050/KA

Verbreidingsset voor brug artikel 3050/600



	A	B	€		
	mm	mm			
3050/KA-O	107,5	2100	1.169,00	1	030500221
3050/KA-G	107,5	2100	1.169,00	1	030500222
3050/KA-R	107,5	2100	1.169,00	1	030500223

3050/MS

Wielklem voor hefbrug artikel 3050/600



Maakt het mogelijk het voorwiel vast te klemmen aan de brug



3050/MS	€ 685,00	1	030500032
---------	----------	---	-----------

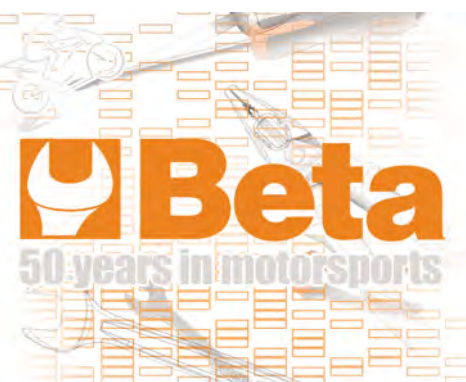

3050/MV

Mechanische wielklem
voor krik 3050/600



3050/MV € 1.159,00 1 030500034

3050/LA

Anti-slip metalen topplaat
voor hefbrug artikel 3050/600

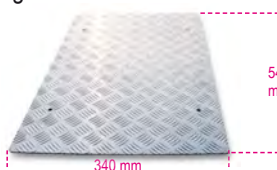

3050/LA € 125,00 1 030500062

9562T1

werkplaats mat 100x80cm

bijzonder geschikt voor gebruik onder motor bandenlichters
BETA 3071 en 3071B"
• gemakkelijk te reinigen, antislip rubber gecoate oppervlak



9562T1 L cm 100 H cm 80 € 107,50 1 095620150

9562T3

Werkplaats mat
Afmetingen: 300x160 cm

- Uitermate geschikt voor het gebruik onder motorfietsen
- Beschermd de vloer tegen olie en benzine vlekken, milieu vriendelijk
- Eenvoudig te reinigen, anti-slip, onderkant mat voorzien van rubber



9562T3 L cm 300 H cm 160 € 425,00 1 095620300

3054

Verrijdbare centrale motorenstandaard of op
het motorfiets achterwiel
met verlenging voor zijstandaard



3054 max kg 500 € 313,00 1 030540000

3055M

Automatische inrijkleem

Maakt het mogelijk het voorwiel van de motorfiets
te fixeren



3055M € 116,50 1 030550002

3057

Aluminium rijplaat voor het laden en uitladen
van motorfietsen

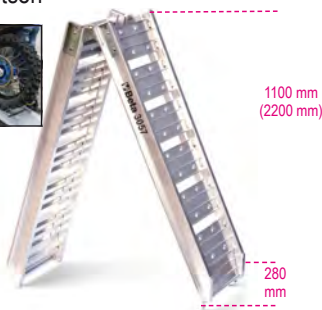

3057 € 240,50 1 030570001

3070B

Handmatige wielbalanceer apparaat



"- Maakt het mogelijk de wielen te balanceren zowel in de
werkplaats als op het circuit
- Voorzien van kogelgelagerde rollen, waterpas en instelbare
voetjes voor ongekende precisie
- Compleet met 2 naaf conussen

3070B € 140,50 1 030700100

3070B/...

balanceer stang
voor balanceer apparaat 3070B



	Ø1	Ø2	L	€		
3070B/10	30	10	410	25,00	1	030700101
3070B/12	30	12	415	30,50	1	030700102
3070B/14	40	14	415	37,00	1	030700103

3070BE/K

Elektronisch handbediend wielbalanceer
apparaat, draagbaar

Balancersysteem met handmatig draaien microprocessor
(zonder motor),
voor het uitbalanceren van auto- of motorwielen van staal of
aluminium



- Compact en gemakkelijk te dragen, voor het gebruik in garages,
bij trucks of in de pitsstraat
- Kan gemonteerd worden op een werkbank of aan de muur
- Software omvat alle onbalanscorrectieprogramma's, aflezen van
posities met kleefgewichten (ALUS), gewichten verborgen achter
spaken (SPLIT) en optimalisatie van onbalans
- Is te gebruiken met kantelbare steun BETA 3070BE/S
(optioneel)

TOEBEHOREN MEEGELEVERD MET WIELBALANCEER
APPARAAT

- Flexibele meetlat
- Opsluitmoer met handwiel en 3 conussen Ø 45 + 110 mm

TECHNISCHE GEGEVENS

Voeding: 115-230V AC of 12-24V DC
Max. opgenomen vermogen: 0.15 kW
Balanceer snelheid: 100 rpm
Meet onzekerheid: 1 g
Velgbreedte: 1.5" + 20" (40 + 510 mm)
Max. wiel gewicht: max. 75 kg

3070BE/K € 3.500,00 1 030700250

3070BE/S

Kantelbare steun voor elektronisch
wielbalanceer apparaat artikel 3070BE

Maakt het mogelijk om de wielbalancer aan een muur of een
werkbank te bevestigen, wat resulteert in meer werkruimte



3070BE/S L mm 514 L1 mm 280 € 1.280,00 1 030700201

3070BE/F

Universele motorfiets flens, Ø 40 mm, voor artikel 3070BE

Voor het gebruik op wielen met een centrale doosteekgaten, Ø 15 ÷ 35 mm, en op flenswielen met uitlijning tot Ø 68 mm



3070BE/F	€ 1.735,00	1	030700202
----------	------------	---	-----------

3070BE/B

Set van 8 opvulbussen voor het uitlijnen van motorfiets wielen voor artikel 3070BE

Geschikt voor het werken met de volgende diameters: 28 - 25 - 22 - 20 - 19.05 - 17 - 16 - 15



3070BE/B	€ 1.905,00	1	030700203
----------	------------	---	-----------

3071A

bandenlichter voor cross- en enduro-motorfietsen

Maakt een gemakkelijke en snelle verwijdering van banden op circuit mogelijk; gebaseerd op een stevig, breed frame van gegalvaniseerd staal, het biedt stevigheid tijdens het verwijderen van de band. Kan worden geïnstalleerd op BETA 3071RS-beugel, voor meer gemak

Functies:

- Ergonomische rubberen handgreep, voor comfortabel en veilig vasthouden van de hendel
- Met rubberen houder voor vergrendelingsstang tijdens transport
- Kan worden gebruikt voor het installeren van cross- en enduro-banden, 17" ÷ 21"

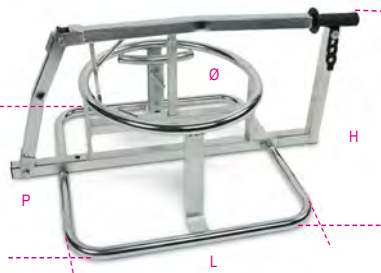

3071A	L mm 570	H mm 400	P mm 850	Ø mm 440	€ 553,00	1	030710000
-------	----------	----------	----------	----------	----------	---	-----------

3071B

bandenlichter voor minibikes en mini-crossmotoren

Maakt een gemakkelijke en snelle verwijdering van banden op racevelden mogelijk; gebaseerd op een stevig, breed frame van gegalvaniseerd staal, het biedt stevigheid tijdens het verwijderen van de band. Kan worden geïnstalleerd op BETA 3071RS-beugel, voor meer gemak

Functies:

- Ergonomische rubberen handgreep, voor comfortabel en veilig vasthouden van de hendel
- Kan worden gebruikt voor de meeste banden van mini bikes te monteren

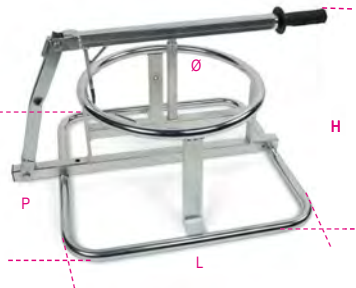

3071B	L mm 570	H mm 330	P mm 650	Ø mm 340	€ 516,00	1	030710010
-------	----------	----------	----------	----------	----------	---	-----------

3071RS

houder voor BETA 3071A en 3071B bandenlichters

Gebruikt om BETA 3071A en 3071B bandenlichters te verhogen, waardoor het verwijderen van banden gemakkelijker wordt; frame gemaakt van gegalvaniseerd staal, met vierkante basis voor meer stevigheid.

- Met 4 bevestigingshaken

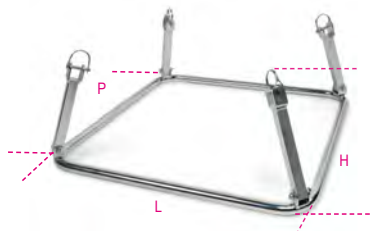

3071RS	L mm 670	H mm 275	P mm 670	€ 240,00	1	030710020
--------	----------	----------	----------	----------	---	-----------

962C

bandenlichters, set, voor cross- en enduro-motorfietsen, minibikes en mini dirty bikes voor gebruik in combinatie met BETA 3071A en 3071B



962C	L mm 420	A mm 30	€ 125,50	1	009620020
------	----------	---------	----------	---	-----------

3072N

motorfiets achterschokdemper demontage unit, handleiding

Maakt een volkomen veilige demontage van de achterschokdemper van een motorfiets mogelijk; door de verstelbare mogelijkheden toepasbaar bij de meeste achterschokdempers; als alternatief kan het worden gebruikt met de meegeleverde plaat.

Functies

- Geschikt voor gebruik op de meeste achterschokdempers van motorfietsen
- Verticaal verstelbaar in 8 standen
- 3 verstelbare armen met verticaal verstelbare houders
- schokdemper vergrendelingsplaat
- met pantograafaansluiting
- met rubberen voetjes
- met schokdemper borgpen

Technische data

Jack verlenging: max. 130 mm

Armverlenging: max. 55 mm

Houderverlenging: max. 18 mm

Stuwkracht: max. 1 t

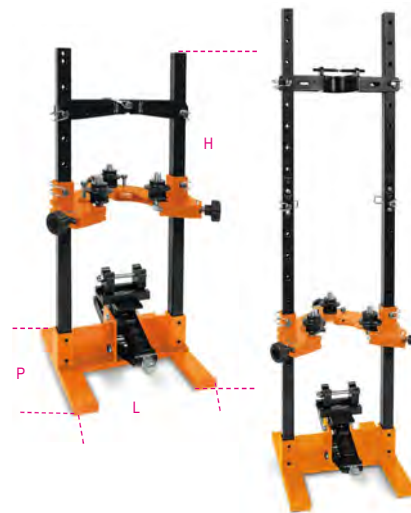

3072N	L mm 390	H mm 785	P mm 390	€ 1.245,00	1	030720010
-------	----------	----------	----------	------------	---	-----------

3073

Universele sleutel voor het plaatsen van oliekeerping bij de vork Voor buis diameters 35 ÷ 48 mm



3073	€ 96,00	1	030730001
------	---------	---	-----------

30740

Voorvork sleutel voor Ohlins elektronische uitvoering

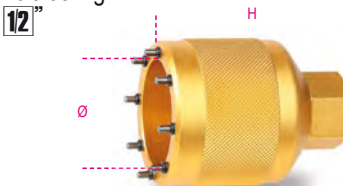

30740	H mm 70,5	Ø mm 50,5	€ 125,00	1	030740001
-------	-----------	-----------	----------	---	-----------

30740/S

Sachs voorvork sleutel voor DUCATI Multistrada

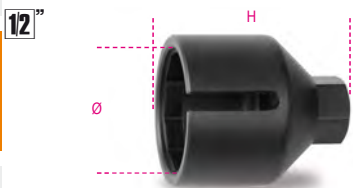

30740/S	H mm	Ø mm	€	1	030740002
	75	65	139,00		

30740/M

Marzocchi voorvork sleutel voor Ducati 1199 en Hypermotard

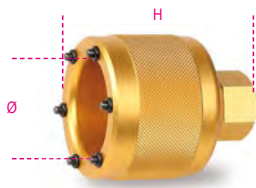

30740/M	H mm	Ø mm	€	1	030740003
	69	55	119,00		

30740/2

Achthoekige Ohlins voorvork sleutel voor DUCATI-motoren



30740/2	H mm	Ø mm	€	1	030740004
	45	65	129,00		

3075A

Zeskant dopsleutels voor wielnaaf

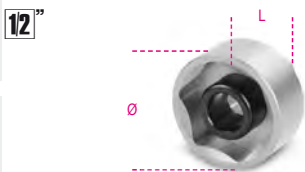

3075A 28	Ø mm	Ø mm	L mm	€	1	030750028
3075A 30	30	40	30	33,50	1	030750030

3075B

Twaalfkant dopsleutels voor wielnaaf

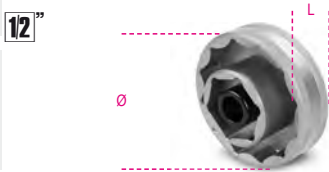

3075B 55	Ø mm	Ø mm	L mm	€	1	030750155
	55	70,7	25	79,50		

3075MV

Twaalfkant dopsleutels voor MV AGUSTA wielnaaf moeren

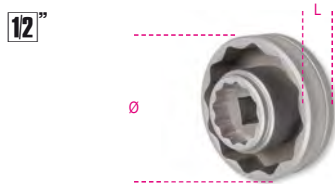

3075MV 56	Ø mm	Ø mm	L mm	€	1	030750156
	56	70,7	30	91,00		

3075/CM

Meervoudige zeskant sleutel voor wielpenen.



3075/CM	€	1	030750212
12-14-17-19-22-24 mm	44,00		

3075/K10

Set bestaand uit universele sleutel met 10 verwisselbare koppen voor het spannen van spaken



Maten: 5.2 - 5.4 - 5.6 - 5.8 - 6.0 - 6.2 - 6.4 - 6.6 - 6.8 - 7.0



3075/K10	€	1	030750410
	60,00		

3079/21

Kabelsmeerder



Maaft een juiste smering mogelijk van de koppelingen en gaskabels, voor een betere werking en langere levensduur.



3079/21	€	1	030790021
	9,30		

3080/C15

Set voor het openen en klinken van de ketting



Ø 3-4-5 mm en Regina kit



3080/C15	€	1	030800015
	401,00		

420x185x60 mm

3080R/CS3

3-delig set reserve stempels voor ketting gereedschap 3080/C15



Ø 3-4-5 mm



3080R/CS3	€	1	030800053
	61,00		

3081

Ketting pons, handzaam



Stevig en opvouwbaar, eenvoudig passend in Enduro gereedschapstas.

Geschikt voor kettingmaten 415, 420, 428, 520, 525, 530, 532



3081	€	1	030810010
	49,50		

3085

Gereedschap voor het uittrekken van remzuigers



Geschikt voor motorfietsen en Scooter remsystemen.



3085	€	1	030850010
	111,00		

3091

Vliegwieltrekkers met binnendraad



	M	€		
3091/10	24x1,5	23,20	1	030910010
3091/20	26x1,0	24,10	1	030910020
3091/25	27x1,0	24,10	1	030910025
3091/30	28x1,0	24,80	1	030910030
3091/40	30x1,0	32,50	1	030910040
3091/45	30x1,5	32,50	1	030910045
3091/50	32x1,5	35,50	1	030910050
3091/60	33x1,5	37,00	1	030910060
3091/70	35x1,0	53,00	1	030910070
3091/75	35x1,5	53,00	1	030910075
3091/80	38x1,5	56,00	1	030910080

3092

Vliegwieltrekkers met buitendraad



	M	€		
3092/10	18x1,5	12,20	1	030920010
3092/20	19x1,0	13,90	1	030920020
3092/25	27x1,0	14,70	1	030920025
3092/30	27x1,25/20x1	14,80	1	030920030
3092/35	22-26x1,5	14,80	1	030920035
3092/40	25x1,5/22x1	14,80	1	030920040
3092/50	26-28x1,0	14,80	1	030920050
3092/60	28x1,5	14,60	1	030920060

3093/E

Blokkeersleutel voor vliegwielen, koppelpedaal en poelies



	€		
3093/E	42,00	1	030930100

3093/U

Meervoudige vliegwieltrekker



	€		
3093/U	39,00	1	030930050
M10x1.25R			
M14x1.5R			
M16x1.5R			
M18x1.5R			
M24x1.0R			
M27x1.0L			

3094PA

Offroad Motorfiets inklapbare service standaard



Metalen frame; poten kunnen in frame worden gevouwen; aanbevolen voor gereedschapsopstelling in de race omgeving verkrijgbaar in 3 kleuren:

- 3094PA-O Oranje
- 3094PA-G Grijs
- 3094PA-R Rood

Optionele accessoires:

- papierrolhouder 3200 PR
- magnetische universele flessenhouder 2499PF/M

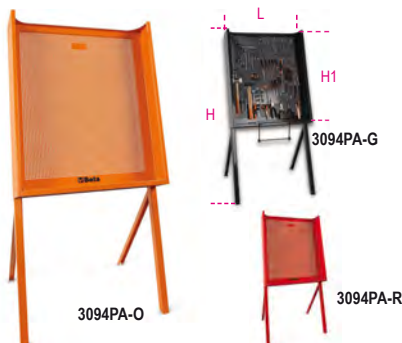

	L	H	H1	€		
	mm	mm	mm			
3094PA-O	750	1555	900	590,00	1	030940101
3094PA-G	750	1555	900	590,00	1	030940102
3094PA-R	750	1555	900	590,00	1	030940103

3095

Werkbank standaard voor motorfiets motoren



verstelbare montagebeugels, voor gemakkelijke, moeiteloze werkbankklussen op motorfiets motoren



	H	P	L	L1	€		
	mm	mm	mm	mm			
3095	360	460	640	460	655,00	1	030950001

3099E

Motorhoes voor buitengebruik, water en vuilbestendig



Beschermt lak tegen krassen, stof en zonlicht



Maat "M" is aanbevolen voor sport en naked bike motoren en middelgrote scooters
Maat "L" is aanbevolen voor maxi enduro en and crossover motorfietsen

		€		
3099E/M	M	93,00	1	030990102
3099E/L	L	114,50	1	030990103

3099T

Motorhoes voor binnengebruik, vervaardigd uit stretch materiaal



Beschermt lak tegen krassen, stof en zonlicht



Maat "M" is aanbevolen voor sport en naked bike motoren en middelgrote scooters

Maat "L" is aanbevolen voor maxi enduro en crossover motorfietsen

Maat "XL" is aanbevolen voor super touring motorfietsen

		€		
3099T/M	M	81,00	1	030990202
3099T/L	L	99,00	1	030990203
3099T/XL	XL	120,00	1	030990204



Beta



FIETS GEREEDSCHAP

Beta is altijd met fietsen bezig geweest. Deze sectie, gericht op fietsgereedschap ontwikkeld voor fietsprofessionals, een nauwkeurige selectie van producten ontworpen voor fiets- en e-bike-onderhoud



Tour de France 2020 and 2021



Partnership 2023

*Official contributor
of Eolo KOMETA cycling*



Partnership 2023



3910

E-bike lift



- Maximaal hefvermogen: 40 kg
- Maximale hoogte centrale ondersteuning: 135 cm
- Ingebouwde wielrichtstandaard
- Innovatief steekasvergrendelingsysteem
- Geleverd met adapterbussen voor de meeste vorken
- Geleverd met vorkverbindingsadapter zonder steekas
- Volledig opvouwbaar en transporteerbaar
- Hefgewicht: 48kg

CE

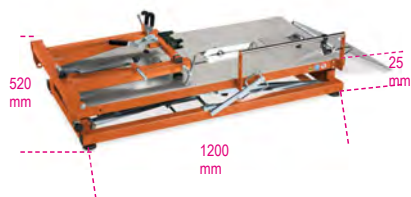

3910 € 3.990,00 1 039100010

3912TP

TOP werkbank voor fietsonderhoud



- Met ondersteuning voor centrale bevestiging, met veiligheids pin
- Gereedschapslade met kogelgelagerde geleiders (490x365x90 mm)
- Ingebouwde wielrichtstandaard
- Innovatief steekasvergrendelingsysteem



3912TP € 1.695,00 1 039120050

3912PP

PRO werkbank voor fietsonderhoud



- Met ondersteuning voor centrale bevestiging, met veiligheids pin
- Ingebouwde wielrichtstandaard
- Innovatief steekasvergrendelings systeem



3912PP € 921,00 1 039120150

3912TP/A

adapterbus voor steekasvorken



Voor werkbanken 3912TP, 3912PP en 3910



L mm 39, Ø mm 30, Ø1 mm 5, € 22,80 1 039120052

3912TP/C

universele adapterbus voor steekasvorken, zeskant aansluiting



Voor werkbanken 3912TP, 3912PP en 3910



L mm 29, Ø mm 30, € 22,80 1 039120054

3912TP/FOX

adapterbussen voor FOX® vorken



Voor werkbanken 3912TP, 3912PP en 3910



L mm 38, € 22,80 1 039120058

3912TP/QRE

adapterpin voor vorken zonder steekassen



Voor werkbanken 3912TP, 3912PP en 3910



L mm 108, € 37,50 1 039120064

3912TP/ROAD

adapterbus voor racevorken



Voor werkbanken 3912TP, 3912PP en 3910



L mm 33, Ø mm 35, € 22,90 1 039120060

3912TP/RS

adapterbus voor ROCKSHOX® steekasvorken



Voor werkbanken 3912TP, 3912PP en 3910



L mm 35, Ø mm 30, € 22,80 1 039120056

3912TP/ST

adapterbus voor SUNTOUR-vorken



Voor werkbanken 3912TP, 3912PP en 3910



L mm 31, Ø mm 30, Ø1 mm 18, € 22,90 1 039120062



3916MMP

werkplaats enkelzijdige klem voor fietsonderhoud

- Klem kan 360° worden gedraaid, met zwevende klemmen en micrometrische afstelling
- Draagvermogen: 25 kg
- Kunststof gereedschapsbak



3916MMP € 828,00 1 039160150

3918MML

enkelzijdige klem, lichtgewicht, opvouwbaar

- Klem 360° draaibaar
- Draagvermogen: 15 kg
- Maximale klemhoogte: 150 cm



3918MML € 336,00 1 039180010

3921

derailleur uitlijner

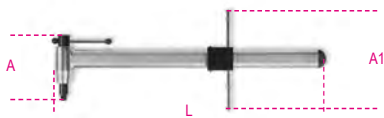

L mm 440 A mm 115 A1 mm 165 € 121,00 1 039210010

3923

Zaaggeleider voor het recht afkorten van voorvorkbuis tot 80 mm en buizen 1" ÷ 1.1/2"



L mm 160 A1 max mm 80 Ø max mm 45 € 59,00 1 039230010

3927

Montage stuurhouder



3927 L mm 365 € 31,50 1 039270010

3932U

Professionele kettingpons geschikt voor kettingen van 5 tot 11 speed.



L mm 164 L1 mm 115 € 57,50 1 039320011

3935

Ketting slijtage meetsleutel



L mm 120 € 9,90 1 039350010

3937

Kettingschakel tang



L mm 170 € 25,50 1 039370010

3948

Cranktrekker

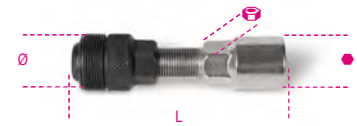

Ø mm 14 L mm 79 Ø mm 20 mm 15 € 20,50 1 039480015

3952

Conussleutel



Ø mm	L mm	€	1	039520013
13	205	26,00	2	039520013
14	205	26,00	2	039520014
15	205	26,00	2	039520015
16	205	26,00	2	039520016
17	205	26,00	2	039520017
18	205	26,00	2	039520018
19	205	26,00	2	039520019
20	205	26,50	1	039520020
21	205	26,50	1	039520021
22	205	26,50	1	039520022
24	205	27,00	1	039520024



3952/S7 182,00 1 039520207
13-14-15-16
17-18-19 mm

3952/S11 288,00 1 039520211
13-14-15-16
17-18-19-20-21-22-24 mm

3953

Pedaalsleutel



Ø mm 15 L mm 401 € 40,50 1 039530015

3955

Dubbele steeksleutels voor universeel balhoofd



Ø mm	L mm	€	1	039550108
30x32	292	37,50	1	039550108
32x36	319	41,50	1	039550114

39613,2

Spaaknippelspanner, zwart, 3,2 mm



Ø mm 3,2 € 14,30 1 039610032

39613,3

Spaaknippelspanner, groen, 3.3 mm



mm 3,3 € 14,30 1 039610033

39613,5

Spaaknippelspanner, rood, 3.5 mm



mm 3,5 € 14,30 1 039610035

3961U

Professionele spaaknippelsleutel, 3.2 - 4.0 mm



mm 3,2 - 4,0 € 23,70 1 039610100

3962SH

Dubbele spaaknippelsleutel voor Shimano



L mm 132 A1 mm 4,3 A2 mm 4,4 € 18,00 1 039620010

3962MV

Dubbele spaaknippelsleutel voor Mavic



L mm 135 A1 mm 4,3 A2 mm 8,4 € 18,80 1 039620020

3963P

Speciale sleutel voor platte spaken



L mm 129 € 8,70 1 039630010

3964

Spaaknippelspanner



L mm 170 L1 mm 89 € 21,70 1 039640010

3965

Wiel centreerboog, ø 20" ÷ 29"



L mm 680 € 104,00 1 039650010

3965C

Professionele wielrichter



- Geschikt voor ø 20" ÷ 29"
- Aswieladapter voor diameter, 10 ÷ 20mm



L mm 500 L1 mm 380 A mm 285 € 465,00 1 039650110

3967

Tandwielverwijderaar met ketting



- Passend tot 11 traps cassettes
- PVC handgreep
- Tevens geschikt voor gemonteerde wielen



L mm 289 € 67,50 1 039670010

3969

Bandenlichter



L mm 200 A mm 15,6 € 10,50 1 039690010

3969K3

Set van 3 bandenlichters, vervaardigd uit kunststof



L mm 113 € 5,75 1 039690130

3971

Sleutel voor Shimano kunststof afdekkoppen



- Geschikt voor Shimano Hollowtech II crankstel



N° 8 mm 8 € 14,00 1 039710010

3972

Trapassleutel



- Geschikt voor Shimano® Hollowtech II, Campagnolo® Ultra-torque, FSA®, SRAM®



L mm 252 € 24,80 1 039720010

3973PF

Lager uitdrijfgereedschap



- Geschikt voor lagers met interne Ø 24 mm en 30 mm



L mm 240 € 33,50 1 039730001

3973/1

16-punts trapasverwijderaar dopsleutel



- Geschikt voor Shimano® XTR BB93, Dura-Ace® BB9000

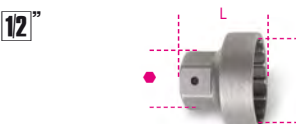

Ø mm 39 mm 24 L mm 34 € 22,90 1 039730010

3973/2

16-punts trapasverwijderaar dopsleutel



• Geschikt voor Shimano® BBR60 (Ultegra® 11 speeds)

12"



Ø mm	● mm	L mm	€	1	039730020
41	24	35	22,90		

3973/3

16-punts trapasverwijderaar dopsleutel



• Geschikt voor Shimano® Hollowtech II, Campagnolo® Ultra-torque, FSA®, SRAM®

12"



Ø int. mm	● mm	L mm	€	1	039730030
46	24	53,5	22,90		

3973/4

20-punts trapasverwijderaar sleutel met centreer pin, vernikkeld



• Geschikt voor Shimano en ISIS

12"

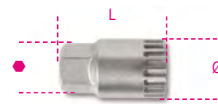

Ø mm	L mm	● mm	€	1	039730040
31,5	55	24	14,00		

3975

Pers voor lagercups



• geschikt voor montage van stuurcups 1", 1.1/8", 1.1/4", 1.1/2" en 2"
NB: Niet te gebruiken met zero stack" doppen



L mm	Ø mm	€	1	039750010
360	16x1	305,00		

3984/1

BMX freewheel verwijderaar, 4 noks

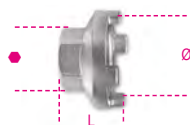

Ø mm	L mm	● mm	€	1	039840010
35	25,5	24	15,90		

3984/2

Shimano freewheel verwijderaar



Ø mm	L mm	● mm	€	1	039840020
22,8	26	24	9,90		

3984/3

Shimano freewheel verwijderaar, cassetteclonking met geleiderpen



12"



Ø mm	L mm	L1 mm	€	1	039840030
23,5	65	25	17,30		

3984/4

Campagnolo freewheel verwijderaar, met geleiderpen



Ø mm	L mm	L1 mm	● mm	€	1	039840040
23	51	13	24	22,30		

3984/5

freewheel verwijderaar dopsleutel, 2 noks



12"



Ø mm	L mm	● mm	€	1	039840050
18,5	38	21	15,50		

3984/6

freewheel verwijderaar dopsleutel, 4 noks



12"



Ø mm	L mm	● mm	€	1	039840060
19,5	36	21	15,50		

3991

Hefboom voor het terugduwen van remblokken



L mm	A mm	α	€	1	039910010
222	36	7°	41,50		

3992

Remschijf sleutel



L mm	A1 mm	€	1	039920010
234	55	27,00		

2115PI/BIKE-HOME



2115PI/BIKE-HOME	361
------------------	-----

M400



M400	543
MV400	543

M401



M401	543
MV401	543

MM400



MM400	548
MMV400	548

MM401



MM401	548
MMV401	548

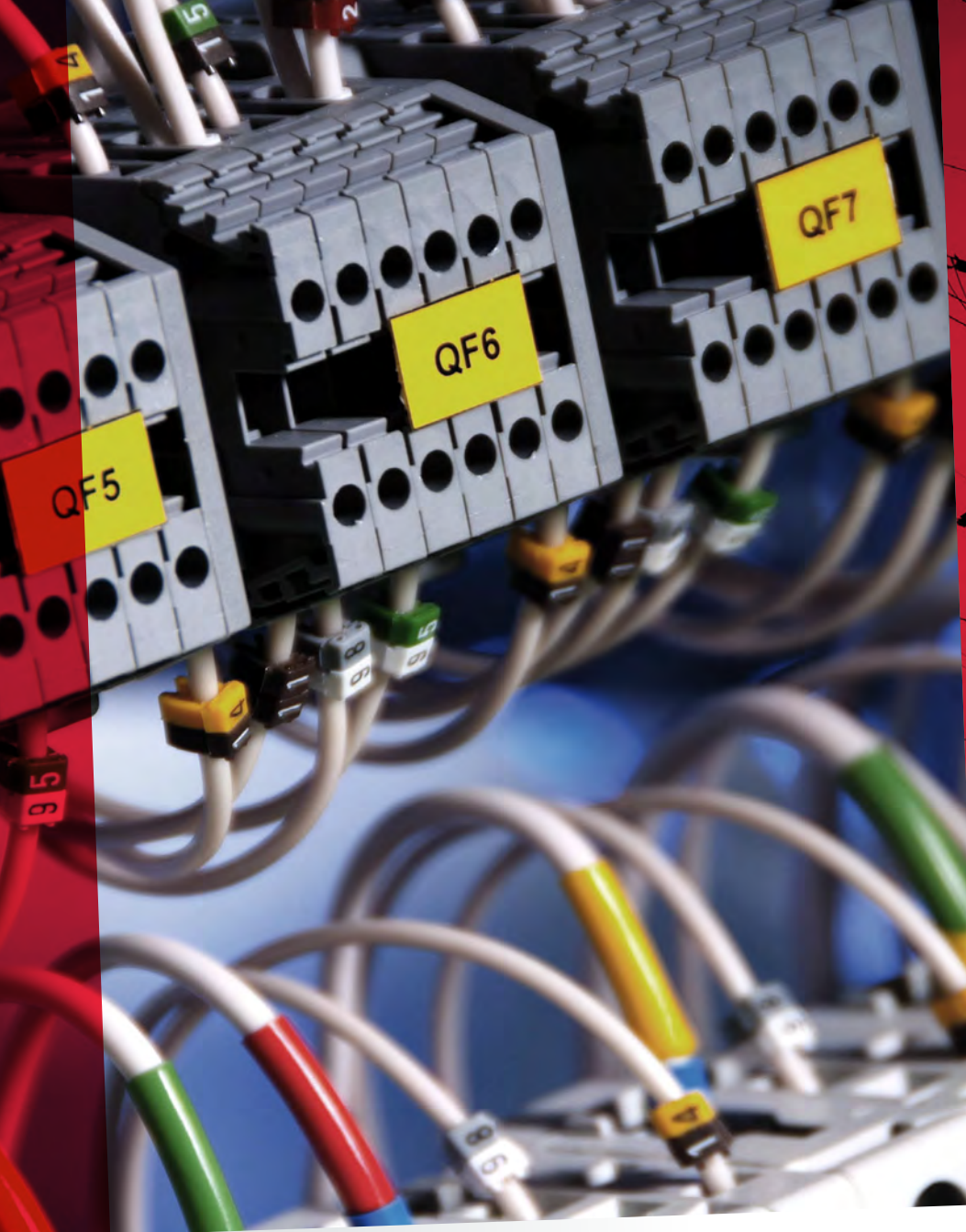

GEISOLEERD GEREEDSCHAP

Beta Utensili's geïsoleerde gereedschappen zijn bedoeld om de veiligheid van de elektriciens en installatiemonteur te garanderen. Met alle geïsoleerde gereedschappen is het mogelijk te werken op systemen tot 1000V wisselstroom en tot 1500 v gelijkstroom. Om de hoogste kwaliteit en werking te garanderen en te controleren of de gereedschappen voldoen aan de norm EN 60900 ondergaan de gereedschappen strenge testen; zoals weerstand van de handgreep tegen het slippen en blootstelling aan hoge temperaturen alsmede een hoog spanningstest (10000V).

Voor assortimenten en inlegbakken, zie desbetreffende sectie.

Alle Beta's geïsoleerde gereedschappen zijn gefabriceerd volgens de normen zoals omschreven in de specificatie EN60900 en zijn goedgekeurd door de meest vooraanstaande Europese certificering instituten.



Istituto Italiano del Marchio di Qualità - I



Verband der Elektrotechnik
Elektronik Informationstechnik - D

1000 V

VEILIGHEIDSTESTS: getest op 10.000 V om te werken aan elektrische installaties van 1.000 V.

Beta's hoog-isolerende gereedschappen worden stuk voor stuk getest op 10 kV, met als doel een ongeëvenaarde kwaliteit te bieden voor werkinstrumenten die vereist zijn om ultra-hoge veiligheidsnormen te garanderen: ze maken het mogelijk om te werken bij spanningen tot 1.000 V a.c. (1500 V d.c.).

VEILIGHEIDSNORMEN:

Hoewel tijdens de productie extreem strenge tests worden uitgevoerd, moet de bediener altijd voor het gebruik van het gereedschap de isolerende handgreep altijd controleren op scheuren, wijzigingen of beschadigingen. Het onveranderd houden van de diëlektrische eigenschappen is nauw verbonden met de mechanische, chemische of thermische spanning waaraan het gereedschap kan worden blootgesteld. In het geval dat de isolator beschadigd raakt, kan het gereedschap niet als veilig worden beschouwd voor gebruik in actieve installaties. Draag altijd een veiligheidsbril en geïsoleerde handschoenen.

UITGEVOERDE TESTEN TIJDENS DE PRODUCTIE



100% visuele test:

alle oppervlakken van het gereedschap moeten vrij zijn van extern zichtbare defecten.



Crashtest:

Na 2 uur bij -25 ° C wordt het gereedschap driemaal geraakt (door een dergelijk specifiek gewicht zoals voorzien in de norm); de isolerende handgreep mag geen tekenen van beschadiging vertonen.



Penetratietest:

een gewicht van 2 kg wordt gedurende twee uur bij +70 ° C op de handgreep van het gereedschap aangebracht. Later wordt een spanning van 5 kV aangelegd op het gebied dat gedurende 3 minuten aan mechanische druk wordt blootgesteld. Er mogen geen tekenen van stroom doorgaan.



Mechanische test:

het gereedschap moet voldoen aan de mechanische prestatie-eisen zoals voorzien in de relevante ISO-normen.



Ontvlamingstest:

een vlam wordt gedurende 10 seconden op het gereedschap gericht; gedurende de volgende 20 seconden mag de vlam een hoogte van 120 mm niet overschrijden.



Dimensionale test:

alle afmetingen van het gereedschap moeten voldoen aan de ontwerpspecificaties.



Elektrische isolatietest:

Na 24 uur onderdompeling in water wordt het gereedschap gedurende 3 minuten onderworpen aan een spanning van 10 kV. De huidige dissipatie mag dergelijke waarden als voorzien in de norm niet overschrijden.



Hechtingstest:

na 168 uur bij +70 ° C wordt het gereedschap onderworpen aan een belasting van 500 N om te controleren of het handvat niet wegglijdt.



Markering leesbaarheidstest:

Na de wrijvingstest met isopropylalcohol moeten markeringen leesbaar blijven.



52MQ

Enkele steeksleutels



1000 V

EN 60900

Ø mm	L mm	€	U	IP
6	90	32,50	1	000520106
7	96	32,50	1	000520107
8	100	32,50	1	000520108
9	108	32,50	1	000520109
10	110	32,50	1	000520110
11	120	32,50	1	000520111
12	132	34,50	1	000520112
13	140	35,50	1	000520113
14	146	38,50	1	000520114
15	166	39,50	1	000520115
16	156	41,00	1	000520116
17	168	41,00	1	000520117
18	170	42,00	1	000520118
19	176	42,50	1	000520119
21	190	46,50	1	000520121
22	200	47,00	1	000520122
24	225	51,50	1	000520124
27	210	65,00	1	000520127
30	240	69,50	1	000520130
32	240	70,50	1	000520132

89MQ

Enkele ringsleutels



1000 V

EN 60900

Ø mm	L mm	€	U	IP
6	150	45,00	1	000890106
7	155	45,00	1	000890107
8	155	45,00	1	000890108
9	160	45,00	1	000890109
10	170	45,00	1	000890110
11	180	45,00	1	000890111
12	190	49,00	1	000890112
13	195	53,00	1	000890113
14	200	54,00	1	000890114
15	210	54,00	1	000890115
16	216	58,50	1	000890116
17	218	58,50	1	000890117
18	236	62,50	1	000890118
19	240	62,50	1	000890119
21	250	73,50	1	000890121
22	255	73,50	1	000890122
24	280	82,50	1	000890124
27	300	85,50	1	000890127
30	320	96,00	1	000890130
32	340	98,00	1	000890132

110MQ

Verstelbare moersleutel met schaalverdeling



1000 V

EN 60900

L mm	A max	€	U	IP
200	28	84,50	1	001100520
250	30	96,00	1	001100525
300	30	141,00	1	001100530

606MQ/50

Momentsleutel met omschakelbare ratel



EN 60900
UNI EN 26789
ISO 6789

Nm	Kgfm	lbf.ft	A mm	L mm	i g
5÷50	0,5÷5	4÷40	90	375	1130

606MQ/50	€	1	006060705
	799,00		

850MQ

Magnetische bithouder, geïsoleerd, met twee componenten handgreep



IMQ CSV
EN 60900

L mm	L1 mm	D mm	€	1	008500910
233	125	12.5	24,30		

910MQ/B

Twaalfkant dopsleutels



EN 60900

Ø mm	L mm	Ø1 mm	Ø mm	€	1	009100616
6	45	14	24	29,00		
7	45	15	24	29,00		
8	45	16	24	29,00		
9	45	17	24	29,00		
10	45	19	24	29,00		
11	45	20	24	29,00		
12	45	24	24	29,00		
13	45	24	24	29,00		
14	45	25	24	29,00		
15	45	27	24	30,50		
16	45	27,5	24	30,50		
17	45	30	24	31,50		
18	45	31	24	31,50		
19	45	32	24	31,50		

910MQ/PE

Dopsleutels voor binnenzeskant schroeven



EN 60900

mm	Ø mm	L mm	€	1	009100604
4	24	100	36,00		
5	24,5	100	36,00		
6	25,0	100	36,00		
8	25,0	100	36,00		
10	25,5	100	37,00		

910MQ/TX

Dopsleutels voor Torx® schroeven



EN 60900

T	Ø mm	L mm	L1 mm	€	1	009100641
T15	23	116	61	44,00		
T20	24,5	116	65	44,00		
T25	24,5	116	65	44,00		
T27	24,5	116	65	44,00		
T30	24,5	116	65	45,00		
T40	24,5	116	65	45,00		

910MQ/XZN

Dopsleutels voor schroeven met XZN® profiel



EN 60900

M	Ø mm	L mm	L1 mm	€	1	009100658
M8	24	106	57	41,00		
M10	24	106	57	42,50		

910MQ/PT

Ingestelde verlengstukken met 3/8" aandrijfvierkant



EN 60900

Nm	L mm	L1 mm	€	1	009100801
12	80	35,5	248,50		

910MQ/21

3/8" verlengstuk



EN 60900

L mm	Ø mm	€	1	009100804
140	13,4	54,00		

910MQ/22

3/8" verlengstuk



EN 60900

L mm	Ø mm	€	1	009100805
265	13,4	60,00		

910MQ/T

3/8" wringstaaf, T-model



EN 60900

L mm	L1 mm	€	1	009100807
200	165	63,50		

910MQ/55

3/8" omschakelbare ratel



EN 60900

L mm	D mm	A mm	€	1	009100808
203	41	67	178,50		

910MQ/C16

8 twaalfkant dopsleutels, 4 binnenzeskant schroevendraaiertoppen en 4 toebehoren



EN 60900

910MQ/C16	€	1	009100917
	808,00		

○ 910MQ/B	8 - 10 - 11 - 12 - 13 - 14 - 17 - 19 mm
○ 910MQ/PE	4 - 5 - 6 - 8 mm
910MQ/21	125 mm
910MQ/22	250 mm
910MQ/T	
910MQ/55	

914MQ/A

Zeskant dopsleutels,
3/8" aandrijvriekant,
vervaardigd van speciale technopolymere op
basis van polyamide

- Speciaal ontwikkeld voor het werken op batterijen van hybride of elektrische voertuigen
- Te gebruiken met een momentsleutel

3/8"



EN 60900

mm	Ø mm	L mm	Ø1 mm	€	U	IP
8	17,5	45	20	15,20	2	009140008
10	20,5	45	20	15,20	2	009140010
13	24	45	20	15,20	2	009140013
17	30	45	22	15,20	2	009140017

3/8"



EN 60900

914MQ-A/S4	€	U	IP
8-10-13-17 mm	64,00	1	009140054

920MQ/A

Dopsleutels zeskant

12"



EN 60900

mm	Ø mm	L mm	Ø1 mm	€	U	IP
8	21,5	57	27,5	29,50	1	009200238
9	21,5	57	27,5	29,50	1	009200239
10	21,5	57	27,5	29,50	1	009200240
11	21,5	57	27,5	29,50	1	009200241
12	23,0	57	27,5	29,50	1	009200242
13	23,0	57	27,5	29,50	1	009200243
14	23,0	57	27,5	31,00	1	009200244
16	23,0	57	27,5	32,00	1	009200246
17	30,0	57	27,5	32,00	1	009200247
18	32,0	57	27,5	33,00	1	009200248
19	32,0	57	27,5	33,00	1	009200249
20	32,0	57	27,5	35,00	1	009200250
21	34,0	57	27,5	35,00	1	009200251
22	36,0	57	27,5	35,00	1	009200252
24	39,0	57	27,5	36,50	1	009200254
27	42,0	57	27,5	37,50	1	009200257
30	44,0	57	27,5	38,50	1	009200260
32	48,0	57	27,5	39,50	1	009200262

920MQ/PE

Schroevendraaierdoppen

12"



1000 V

EN 60900

	Ø mm	L mm	L1 mm	€	U	IP
*4	28,5	94,50	10,5	49,50	1	009200264
*5	28,5	94,5	10,5	49,50	1	009200265
*6	28,5	94,5	10,5	49,50	1	009200266
*8	28,5	94,5	10,5	49,50	1	009200268
10	28,5	94,5	10,5	51,50	1	009200267
12	28,5	94,5	10,5	51,50	1	009200269

920MQ/21

1/2" verlengstuk

12"



EN 60900

L mm	Ø mm	€	U	IP
135	28	57,50	1	009200804

920MQ/22

1/2" verlengstuk

12"



EN 60900

L mm	Ø mm	€	U	IP
264	30	65,50	1	009200805

920MQ/T

1/2" wringstaaf T-model

12"



EN 60900

L mm	L1 mm	€	U	IP
200	163	69,00	1	009200807

920MQ/55A

1/2" omschakelbare ratel met blokkeermechanisme

12"



EN 60900

L mm	D mm	A mm	€	U	IP
240	50	89	256,00	1	009200809

920MQ/C16

9 zeskant dopsleutels,
3 schroevendraaierdoppen
en 4 toebehoren

12"



EN 60900

920MQ/C16	€	U	IP
	953,00	1	009200917

920MQ/A	8 - 10 - 12 - 13 - 14 - 17 - 19 - 22 - 24 mm
920MQ/PE	5 - 6 - 8 mm
920MQ/21	135 mm
920MQ/22	264 mm
920MQ/55A	
920MQ/T	

420x280x60 mm - 5,2 kg

943MQ

Dopschroevendraaier zeskant dop



EN 60900

mm	L mm	L1 mm	D mm	€	U	IP
5,5	233	125	12,2	19,40	1	009430235
6	233	125	12,5	19,40	1	009430236
7	240	125	14,3	20,80	1	009430237
8	240	125	15,3	21,50	1	009430238
10	252	125	17,3	22,50	1	009430240
13	252	125	21,3	23,90	1	009430243

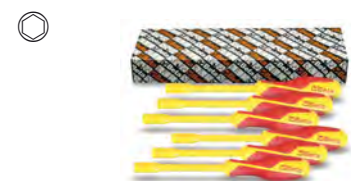

943MQ/S6	€	U	IP
5,5-6-7-8-10-13 mm	127,50	1	009430250

951MQ

T-zeskantsleutels



EN 60900

mm	L mm	L1 mm	€	U	IP
3	120	105	49,00	1	009510703
*4	165	105	49,00	1	009510704
*5	170	105	49,00	1	009510705
*6	168	105	49,00	1	009510706
*8	165	105	50,50	1	009510708
10	200	105	53,50	1	009510710

993MQ

Gebogen pincet



EN 60900

L mm	€	1	009930040
147	40,50	1	009930040

994MQ

Rechte pincet



EN 60900

L mm	€	1	009940040
145	39,50	1	009940040

1010MQ

Buigtang met ronde bekken



EN 60900

L mm	L1 mm	€	1	010100096
160	51,5	51,00	1	010100096

1048MQ

Waterpomptang, doorgestoken scharnier

• Verchroomde uitvoering



EN60900

L mm	A max mm	L1 mm	€	1	010480315
250	48	39	69,50	1	010480315

1082MQ

Zijkniptangen



EN 60900

L mm	L1 mm	mm	€	1	010820094
140	20	1,6	39,00	1	010820094
160	22	1,6	42,00	1	010820096

1084MQ

Zijkniptang, zware uitvoering



EN 60900

L mm	L1 mm	mm	€	1	010840100
200	26	2,0	66,00	1	010840100

1088MQ

Kopkniptang



EN 60900

L mm	L1 mm	mm	€	1	010880096
160	7	1,6	62,50	1	010880096

1128MQ

Electricienschuur, roestvast stalen bladen, met microvertanding



IEC60900

L mm	L1 mm	€	1	011280101
145	45	52,00	1	011280101

1132MQ

Kabelschaar met geïsoleerde handgreep voor koper en aluminium kabels



EN 60900

L mm	mm	€	1	011320193
230	18	91,00	1	011320193

1142MQ

Draadstriptang



EN 60900

L mm	mm²	€	1	011420096
160	0,5÷6	45,00	1	011420096

1150MQ

Combinatietangen hoog verchroomd



EN 60900

L mm	L1 mm	mm	€	1	011500496
160	37	1,6	39,00	1	011500496
180	39	1,8	42,00	1	011500498
200	43	2,0	52,50	1	011500500
220	46	2,0	56,00	1	011500502

1162MQ

Telefoontangen met lange platte bekken verchroomd



EN 60900

L mm	L1 mm	mm	€	1	011620096
160	56	1,6	52,00	1	011620096
200	76	1,6	54,50	1	011620100

1164MQ

Telefoontang, extra-lange gebogen bekken



L mm	L1 mm	mm	€	1	011640096
160	54	1,6	54,00	1	011640096
200	76	1,6	57,00	1	011640100

1166MQ

Telefoontangen met lange halfronde bekken verchroomd



EN 60900

L mm	L1 mm	mm	€	1	011660096
160	56	1,6	42,00	1	011660096
200	76	1,6	45,00	1	011660100

1168MQ

Telefoontangen met lange halfronde gebogen bekken verchromd



EN 60900

L mm	L1 mm	mm	€	🔌	📄
160	50	1,6	49,00	1	011680096
200	70	1,6	55,00	1	011680100

1169MQ/D2

2-delig geïsoleerde tangen assortiment bestaande uit: combinatietang en diagonaal knippende zijknijptang.



EN 1000 V

1169MQ/D2	€	🔌	📄
1150MQ 180 mm	84,00	1	011690152
1082MQ 160 mm			

1272MQF

schroevendraaiers voor Phillips® kruisschroeven. dun

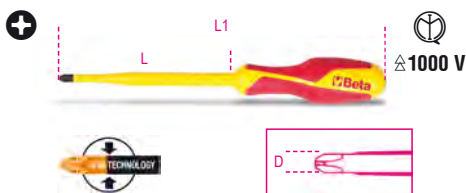

EN 60900

PHxDxL mm	L1 mm	€	🔌	📄
1x4,5x80	187	14,30	3	012720609
2x6x100	218	16,10	3	012720618

1272MQ

Schroevendraaiers voor Phillips® kruisschroeven

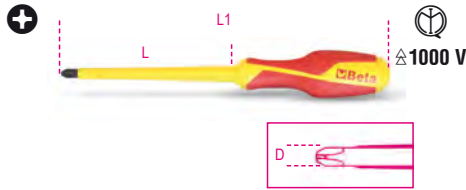

EN 60900

PHxDxL mm	L1 mm	€	🔌	📄
0x3x60	160	10,10	3	012720703
1x4,5x80	187	12,30	3	012720709
2x6x100	218	14,20	3	012720718
3x8x150	276	18,60	2	012720724
4x10x200	326	21,60	2	012720727



1272MQ/S5	€	🔌	📄
PH0x3x60-PH1x4,5x80 PH2x6x100-PH3x8x150 PH4x10x200 mm	77,00	1	012720751

1273MQF/D...

Set van 6 dunne schroevendraaiers voor verzonken sleufschroeven



1273MQF/D4	€	🔌	📄
1272MQF 1x4,5x80-2x6x100 mm 1274MQF 0,6x3,5x100-1x5,5x125 mm	57,00	1	012730604

1273MQF/D6	€	🔌	📄
1272MQF 1x4,5x80-2x6x100 mm 1274MQF 0,6x3,5x100-1x4,5x100 1x5,5x125-1,2x6,5x150 mm	87,50	1	012730606

1273MQ/D6

6-delig set van schroevendraaiers



1273MQ/D6	€	🔌	📄
1274MQ 0,5x3x100-0,8x4x100 1,0x5,5x125 mm 1272MQ PH0x3x60 -PH1x4,5x80 PH2x6x100 mm	71,00	1	012730851

1274MQF

Schroevendraaiers voor verzonken sleufschroeven dun

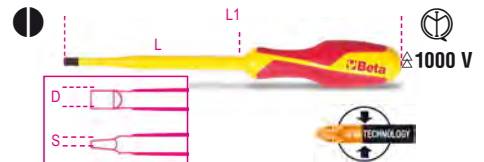

EN 60900

SxDxL mm	L1 mm	€	🔌	📄
0,6x3,5x100	200	12,20	3	012740603
1x4,5x100	205	13,60	3	012740606
1x5,5x125	232	14,30	3	012740609
1,2x6,5x150	268	17,10	3	012740612

1274MQ

Schroevendraaiers voor verzonken sleufschroeven

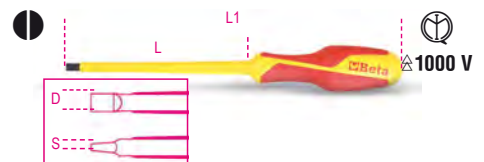

EN 60900

SxDxL mm	L1 mm	€	🔌	📄
0,4x2,5x75	175	9,75	3	012740700
0,5x3x100	200	10,10	3	012740703
0,8x4x100	207	11,80	3	012740706
1x5,5x125	232	12,70	3	012740709
1,2x6,5x150	268	15,70	3	012740712
1,2x8x175	301	18,10	2	012740715
1,6x10x200	326	20,80	2	012740718



1274MQ/S6	€	🔌	📄
0,5x3x100-0,8x4x100 1x5,5x125-1,2x6,5x150 1,2x8x175-1,6x10x200 mm	89,00	1	012740751

1275MQ/C

Schroevendraaiers voor gecombineerde PH kruis en sleufschroeven

Slank

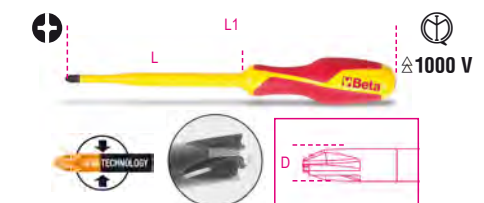

EN 60900

PH1+LPP	€	🔌	📄
PH1+LPP	12,90	2	012750409
PH2+LPP	14,90	2	012750418

1276MQ/C

Schroevendraaiers voor gecombineerde PZ kruis en sleufschroeven

Slank

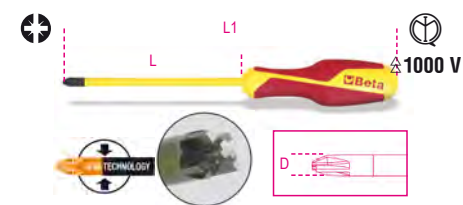

EN 60900

	€		
☉ PZ1+LPP	12,10	2	012760409
☉ PZ2+LPP	14,10	2	012760418

1279MQ/F

Schroevendraaiers voor Pozidriv®-Supadriv® schroeven

Slank

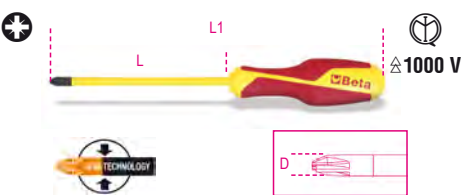

EN60900

pz	L mm	L1 mm	€		
1	80	187	12,90	3	012790409
2	100	218	14,90	3	012790418

1279MQ

Geïsoleerde schroevendraaiers voor Pozidriv®-Supadriv® kruiskop schroeven



EN 60900

PZ	L mm	L1 mm	€		
0	60	160	10,30	3	012790703
1	80	187	12,20	3	012790709
2	100	218	14,20	3	012790718
3	150	276	18,80	2	012790724



	€		
1279MQ/S4 PZ 0-1-2-3	55,50	1	012790751

1725MQ

Mini zaagbeugel



EN 60900

	L mm	H mm	€		
1725MQ	260	85	95,00	1	017250030

1777MQ/C

Kabelstripmes geïsoleerd

• voor multikern kabels



EN 60900

	L mm	€		
1777MQ/C	190	39,00	1	017770026

1777MQ/U

Stripmes, geïsoleerd



EN 60900

	L mm	€		
1777MQ/U	190	34,00	1	017770011

1777RL/U

4 reserve mes voor artikelen 1777MQ/U



	€		
1777RL/U	29,00	1	017770021

1995MQ/T

Isolatie mat

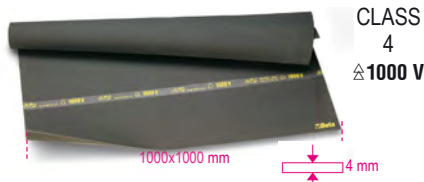

VDE 0303
EN 60243

	LxSxH mm	€		
1995MQ/T	1000x1000	305,00	1	019950030

1995MQ/G1- G2

Isolerende handschoenen vervaardigd uit latex

CE ☉ 1000 V



EN 60903

	Gr.	L mm	€		
1995MQ/G1	9	410	122,50	1	019950010
1995MQ/G2	10	410	122,50	1	019950013

1996MQ/T

Isolatie mat

500x500mm

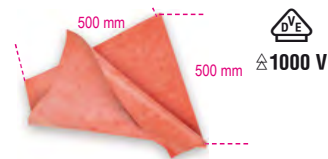

DIN EN 61112

	S mm	€		
1996MQ/T0,5	1.0	93,50	1	019960005

1996MQ/GM

Composiet isolerende handschoenen

EN60903
EN388

CE ☉ 1000 V



EN 60903
EN 61482

	Gr.	L mm	€		
1996MQ/GM 9	9	410	157,50	1	019960109
1996MQ/GM 10	10	410	157,50	1	019960110

1996SVG

Pneumatisch apparaat voor het testen van geïsoleerde handschoenen

Het verplichte testen volgens EN90603



	€		
1996SVG	361,00	1	019960133

2115P L-MQ32



2115PL-MQ32		362

2029EM



2029EM		355

5989 VEM



5989 VEM		517



GEREEDSCHAP MET VALBEVEILIGING

Beta H-SAFE

Het assortiment H-SAFE-gereedschap van Beta omvat meer dan 200 referenties, waarvoor een afzonderlijk bevestigingssysteem is ontworpen om het bestand te maken tegen de zwaarste mechanische belasting als garantie voor een maximale veiligheid.

Het gebruiksgemak is ook belangrijk, want gereedschap met een dubbele gebruikseinden, zoals de ringsteeksleutel art.42, is gekoppeld met een kabel die over de hele lengte van het gereedschap verschuifbaar is, terwijl gereedschap dat met draaibewegingen werkt, bijvoorbeeld een schroevendraaier, met vrije draairingen wordt gekoppeld om te voorkomen dat de veiligheidskabel in elkaar draait.



Het H-SAFE veiligheidssysteem van Beta is ontwikkeld, getest en geproduceerd in de fabrieken van Beta Met het H-SAFE veiligheidssysteem van Beta is het gereedschap altijd comfortabel en veilig binnen handbereik



35HS

Koudbeitels, geprofileerd model H-SAFE





L mm	A mm	€		
200	23,0	48,00	1	000354004
250	28,5	61,50	1	000354005

42HS

Ringsteeksleutels H-SAFE



DIN 3113 UN-HISO 7738

	L mm	€		
6x6	95	23,90	1	000424506
7x7	105	24,40	1	000424507
8x8	116	24,50	1	000424508
9x9	127	25,50	1	000424509
10x10	137	26,00	1	000424510
11x11	148	26,50	1	000424511
12x12	158	26,50	1	000424512
13x13	169	26,50	1	000424513
14x14	180	28,50	1	000424514
15x15	190	29,00	1	000424515
16x16	201	29,50	1	000424516
17x17	212	31,00	1	000424517
18x18	222	32,00	1	000424518
19x19	233	33,00	1	000424519
20x20	243	33,50	1	000424520
21x21	254	36,00	1	000424521
22x22	264	37,50	1	000424522
23x23	275	39,00	1	000424523
24x24	285	40,50	1	000424524
25x25	296	42,50	1	000424525
26x26	307	44,00	1	000424526
27x27	317	45,50	1	000424527
28x28	328	46,50	1	000424528
29x29	338	49,50	1	000424529
30x30	349	51,50	1	000424530
32x32	370	56,50	1	000424532
34x34	391	94,50	1	000424534
36x36	412	98,50	1	000424536

42HS/AS

Ringsteeksleutels H-SAFE



	L mm	€		
1/4x1/4	95	26,50	1	000424106
5/16x5/16	116	26,50	1	000424108
3/8x3/8	137	28,00	1	000424110
7/16x7/16	148	28,50	1	000424111
1/2x1/2	169	29,00	1	000424113
9/16x9/16	180	29,50	1	000424114
5/8x5/8	201	32,00	1	000424116
11/16x11/16	212	32,50	1	000424117

Ø	L mm	€	Hand	Computer
3/4x3/4	233	34,50	1	000424119
13/16x13/16	254	38,50	1	000424121
7/8x7/8	264	39,00	1	000424122
15/16x15/16	285	43,50	1	000424124
1x1	296	45,00	1	000424125
1.1/16x1.1/16	317	48,50	1	000424127
1.1/8x1.1/8	338	51,00	1	000424129
1.1/4x1.1/4	370	59,00	1	000424132
1.5/16x1.5/16	391	91,00	1	000424133

55HS

Dubbele steeksleutels H-SAFE



UNI-ISO 10102 DIN 3110

Ø mm	L mm	€	Hand	Computer
• 6x7	120	20,30	1	000554012
• 8x9	140	20,90	1	000554021
• 10x11	155	21,60	1	000554030
• 12x13	170	22,40	1	000554042
• 14x15	185	23,70	1	000554054
• 16x17	202	25,50	1	000554060
• 18x19	220	26,50	1	000554066
• 20x22	236	28,50	1	000554075
• 21x23	245	29,50	1	000554078
• 22x24	245	32,00	1	000554081
• 24x27	262	34,50	1	000554090
• 30x32	297	42,00	1	000554108
• 34x36	325	98,00	1	000554117

91HS-C

Opzetrijnsleutels H-SAFE



Ø mm	Ø mm	€	Hand	Computer
36	54	110,50	1	000914036
41	62	131,00	1	000914041
46	69	149,00	1	000914046

91HS

Opzetrijnsleutels H-SAFE



Ø mm	Ø mm	€	Hand	Computer
36	54	222,50	1	000914236
41	62	243,00	1	000914241
46	69	285,00	1	000914246

92HS

Handgreep voor model 91



L mm	91 mm	Ø mm	€	Hand	Computer
610	32=41	22	112,00	1	000924020
760	46=55	25	136,00	1	000924030

93HS

Dubbele ringsleutel voor verzonken moeren H-SAFE



Ø mm	L mm	€	Hand	Computer
21x22	310	69,50	1	000934021

96TBP-HS

Zeskant stiftsleutel met kogelkop en kunststof handgreep en H-SAFE systeem



Ø mm	L mm	L1 mm	Ø mm	€	Hand	Computer
2,5	153	55	4	31,00	1	000964685
3	153	55	4	33,00	1	000964686
4	179	70	5	33,50	1	000964687
5	200	84	6	34,00	1	000964688
6	221	103	7	36,50	1	000964689
8	255	117	10	42,00	1	000964690
10	285	132	12	46,00	1	000964692

96THS

Haakse stiftsleutels met kracht handgreep H-SAFE

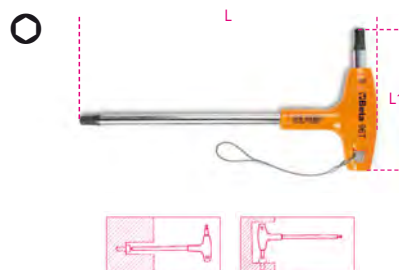

mm	L mm	L1 mm	€	Hand	Computer
2,5	153	55	29,50	1	000964935
3	153	55	30,00	1	000964936
4	179	70	31,00	1	000964938
5	200	84	32,50	1	000964940
6	221	103	33,50	1	000964941
8	255	117	39,00	1	000964943
10	285	132	44,00	1	000964945

96THS-AS

Haakse stiftsleutels met kracht handgreep H-SAFE



Ø "	L mm	L1 mm	Ø mm	€	Hand	Computer
5/32	200	84	6	33,00	1	000964673
3/16	200	84	6	33,50	1	000964674
7/32	221	103	7	37,50	1	000964675
1/4	236	106	8	38,00	1	000964676
5/16	255	117	10	40,00	1	000964678
3/8	285	132	12	45,50	1	000964680

97TTXHS

Haakse stiftsleutels voor Torx® schroeven en krachthandgreep H-SAFE

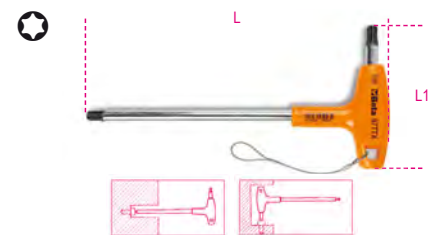

Ø	L mm	L1 mm	€	Hand	Computer
T10	179	70	31,00	1	000974710
T15	179	70	32,00	1	000974715
T20	179	70	32,50	1	000974720
T25	179	70	33,00	1	000974725
T30	200	84	36,00	1	000974730
T40	221	103	37,50	1	000974740
T45	236	106	40,50	1	000974745
T50	255	117	49,00	1	000974750

111E-HS

verstelbare moersleutels met schaalverdeling, verchromd

met H-SAFE systeem

- Rechts draaien van pen
- Mm/inch-schaal



DIN 3117 ISO 6787

L mm	L "	A max mm	€	Hand	Computer
200	8	29	61,00	1	001114120
250	10	34	69,00	1	001114125
300	12	40	85,50	1	001114130
380	15	45	146,00	1	001114138
450	18	54	230,50	1	001114145

142HS

Omschakelbare ratelringsteeksleutels H-SAFE

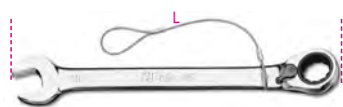

mm	L mm	€		
8x8	136	38,00	1	001424008
9x9	143	38,50	1	001424009
10x10	159	39,00	1	001424010
11x11	168	40,00	1	001424011
12x12	174	40,50	1	001424012
13x13	180	41,50	1	001424013
14x14	190	43,00	1	001424014
15x15	200	45,00	1	001424015
16x16	216	47,50	1	001424016
17x17	233	50,00	1	001424017
18x18	239	52,50	1	001424018
19x19	248	53,00	1	001424019
21x21	285	60,50	1	001424021
22x22	285	62,50	1	001424022
24x24	325	71,50	1	001424024
27x27	355	95,00	1	001424027
30x30	420	110,50	1	001424030
*32x32	420	118,00	1	001424032

360HS

Pijpentangen, Stillson model H-SAFE



L mm	Ø max " mm	€		
250	1" gas	59,50	1	003604025
350	1 1/2" gas	74,50	1	003604035
450	2" gas	96,00	1	003604045
600	2 1/2" gas	137,50	1	003604060



LC system, het veiligheidssysteem met dubbele kogel. De dop wordt alleen met de knop geopend.

666HS

ZERO-RESET momentsleutels met kliktype met omkeerbare ratels, voor rechtsom aandraaien, koppeling nauwkeurigheid: ± 3%

met H-SAFE systeem

Niet nodig om sleutel terug naar '0' te draaien



ISO 6789

Nm	■	D mm	A mm	L mm	LC system	g	■
10÷50	3/8	30	33	342	-	680	0,25

666HS/5	€		
325,00	1	006664705	

Nm	■	D mm	A mm	L mm	LC system	g	■
20÷100	3/8	30	33	385	-	760	0,25

666HS/10	€		
330,00	1	006664710	

Nm	■	D mm	A mm	L mm	LC system	g	■
40÷200	1/2	42	43	471	*	1020	0,5

666HS/20LC	€		
375,00	1	006664721	

Nm	■	D mm	A mm	L mm	LC system	g	■
60÷300	1/2	42	43	600	*	1270	1,0

666HS/30LC	€		
395,00	1	006664731	

900E-HS/55

Omschakelbare rate H-SAFE



DIN 3122 - UNI-ISO 3315

L mm	Ø mm	A mm	■	€		
125	25	18	1/4	61,00	1	009004880

910E-HS/55

Omschakelbare rate H-SAFE



DIN 3122 - UNI-ISO 3315

L mm	Ø mm	A mm	■	€		
200	30	33	3/8	68,00	1	009104880

920E-HS/55LC

Omschakelbare rate H-SAFE Locking System



DIN 3122 - UNI-ISO 3315

L mm	Ø mm	A mm	■	€		
275	40	43	1/2	99,00	1	009204860

932HS

Gebogen pijpsleutels, twaalfkant en zeskant hoogglanzend verchroomd H-SAFE

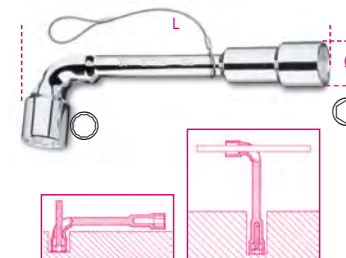

NF E 74.303

mm	Ø mm	L mm	€		
6x6	11,5	110	31,00	1	009324006
7x7	12,5	116	32,00	1	009324007
8x8	13,0	120	33,50	1	009324008
9x9	14,0	125	34,00	1	009324009
10x10	16,5	133	35,00	1	009324010
11x11	17,5	143	37,00	1	009324011
12x12	19,0	148	38,00	1	009324012
13x13	19,5	154	38,50	1	009324013
14x14	21,5	167	41,00	1	009324014
15x15	22,5	182	41,50	1	009324015
16x16	24,5	193	43,00	1	009324016
17x17	26,0	198	43,50	1	009324017
18x18	26,5	215	47,00	1	009324018
19x19	29,0	220	49,50	1	009324019

1032HS

Borgveertangen, inwendig rechte punten PVC handgreep H-SAFE



UNI 7914 DIN 5256

L mm	Ø mm	Ø1 mm	A mm	€		
140x1,3	12÷25	1,3	20	48,50	1	010324014
180	19÷60	1,9	21	47,50	1	010324017

Beta

1034HS

Borgveertangen, inwendig 90° gebogen punten
PVC handgreep H-SAFE



UNI 7914 DIN 5256

L	Ø	Ø1	A	€	🔧	📄
mm	mm	mm	mm			
170	19+60	1,9	21	49,00	1	010344017

1036HS

Borgveertangen, uitwendig rechte punten PVC
handgreep H-SAFE



UNI 7915 DIN 5254

L	Ø	Ø1	A	€	🔧	📄
mm	mm	mm	mm			
140x1,3	10+25	1,3	20	48,00	1	010364014
175	19+60	1,9	21	47,50	1	010364017

1038HS

Borgveertangen, uitwendig 90° gebogen
punten PVC handgreep H-SAFE



UNI 7915 DIN 5254

L	Ø	Ø1	A	€	🔧	📄
mm	mm	mm	mm			
175	19+60	-	21	51,50	1	010384017

1048BM-HS

Waterpomptangen, doorgestoken scharnier,
twee componenten handgreep H-SAFE

• nieuw model 9 instelposities



ISO 8976

L	A max	L1	g	€	🔧	📄
mm	mm	mm	g			
250	48	39	460	72,50	1	010484215

1052HS

Verstelbare griptangen halfronde bekken
H-SAFE



L	A	A1 max	S	€	🔧	📄
mm	mm	mm	mm			
240	72	42	10,0	63,50	1	010524024

1082BM-HS

Zijkniptangen twee componenten handgreep
H-SAFE



UNI/ISO 5749

L	L1	mm	A	€	🔧	📄
mm	mm	mm	mm			
160	22	1,6	28,0	66,00	1	010824036

1088BM-HS

Kopkniptangen twee componenten handgreep
H-SAFE

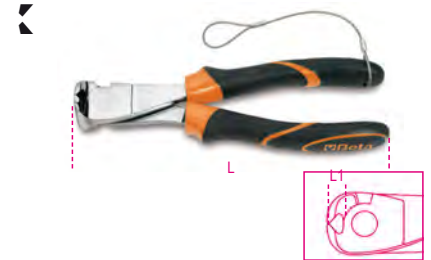

UNI/ISO 5748

L	L1	mm	A	€	🔧	📄
mm	mm	mm	mm			
160	9	1,6	28,0	75,00	1	010884036
200	11	2,0	36,0	91,00	1	010884040

1128BAX-HS

Dubbel snijdende electricien schaar, met
trapsgewijze ruimers in roestvast staal met
DLC-coating H-SAFE

Dubbel snijdende werking: een speciale nok op het draaipunt
maakt het mogelijk de bladen in de lengte te verplaatsen
waardoor de snijkraft toeneemt bij het sluiten van de bladen.

Vorm en ruimers: ontworpen voor het vergroten van gaten in
kunststof van 13 mm tot 24 mm.

DLC coating: DLC (diamond-like carbon) is een innovatieve,
op koolstof gebaseerde coating: de grote hardheid en het lage
coëfficiënt van wrijving welke ontstaat van het gelijktijdig
aanwezig zijn van koolstof, in de vorm van grafiet, op het
oppervlakte en diamant.

- Hoge oppervlakte hardheid van de bladen (weerstand tegen het bot worden en slijtage)
- Laag coëfficiënt van wrijving (gladde en anti kleef)
- Eccentrische borgpen
- Grote handgrepen met groeven voor het klemmen van ronde delen
- Met beweegbare kunststof houder



L	L1	mm ²	€	🔧	📄
mm	mm	mm ²			
150	50	50	60,00	1	011284088



1132BM-HS

Kabelscharen verchromd twee componenten handgreep H-SAFE



UNI 8791

L	mm	A	B	€		
230	18	37	12,5	104,50	1	011324143

1150BM-HS

Combinatietangen hoog verchromd twee componenten handgreep H-SAFE



ISO 5746

L	L1	mm	A	€		
160	42	1,6	22,0	53,00	1	011504146
180	46	1,8	25,0	57,00	1	011504148
200	50	2,0	27,0	61,50	1	011504150

1166BM-HS

Telefoontangen, lange halfronde bekken verchromd twee componenten handgreep H-SAFE



ISO 5745

L	L1	mm	A	€		
200	76	1,6	22,0	61,50	1	011664040

1168BM-HS

Telefoontangen, lange halfronde gebogen bekken, verchromd, twee componenten handgreep H-SAFE



ISO 5745

L	L1	mm	A	€		
200	70	1,6	22,0	67,00	1	011684040

1290HS

Schroevendraaier voor sleufschroeven H-SAFE



ISO 2380

SxAxL	L1	Ø	€		
0,4x2,5x75	171	2,5	22,00	1	012904006
0,5x3x100	196	3,0	22,40	1	012904012
0,6x3,5x100	196	3,5	23,10	1	012904021
0,8x4x100	196	4,0	23,60	1	012904030
0,8x4x150	246	4,0	25,50	1	012904036
1x5,5x150	259	5,0	28,00	1	012904042
1,2x6,5x150	270	6,0	29,00	1	012904051
1,2x8x150	282	7,0	32,00	1	012904057
1,6x10x200	332	8,0	36,50	1	012904066

1292HS

Schroevendraaier voor Philips® kruiskopschroeven H-SAFE



UNI/ISO 8764

PHxDxL	L1	€		
0x3x100	196	22,70	1	012924006
1x4,5x120	229	24,70	1	012924012
2x6x150	270	29,00	1	012924021
3x8x150	282	33,50	1	012924024

1294HS

Schroevendraaier voor verzonken sleufschroeven H-SAFE



SxDxL	L1	€		
0,5x2,5x60	156	21,40	1	012944003
0,6x3x75	171	21,90	1	012944006
0,8x4x100	196	23,50	1	012944012
1x5x125	234	26,50	1	012944018

1299HS

Schroevendraaier voor kruiskop Pozidriv® - Supadriv® schroeven H-SAFE



UNI/ISO 8764

PZ	L	L1	€		
0	60	156	24,00	1	012994000
1	80	189	26,00	1	012994003
2	100	220	32,00	1	012994006
3	150	282	39,00	1	012994009

1370T-HS

Bankhamer, kunststof steel H-SAFE



g	A	L	L1	€		
300	23	300	105	46,50	1	013704630
500	27	320	118	50,50	1	013704650
1000	36	360	135	61,00	1	013704700



1370FT-HS

Klinkhamer, kunststof steel met glasfiber kern H-SAFE



A	L	L1	B	€		
mm	mm	mm	mm			
28	280	86	22	60,00	1	013704528
30	280	92	24	61,00	1	013704530
36	300	104	29	72,50	1	013704536

1390HS

Kunststof hamers met verwisselbare koppen houten steel H-SAFE



UNI 7784

D	L	L1	€		
mm	mm	mm			
35	310	95	61,50	1	013904035
45	320	107	85,50	1	013904045

1392HS

Terugslagvrije hamers met verwisselbare koppen stalen steel H-SAFE



D	L	L1	€		
mm	mm	mm			
35	305	115	90,50	1	013924035
40	310	125	97,00	1	013924040
50	325	135	112,00	1	013924050
60	385	155	158,50	1	013924060

1602A-HS

Kabelschroentang voor geïsoleerde kabelschoenen H-SAFE

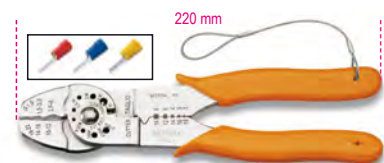

mm²	L	A	B	€		
	mm	mm	mm			
0÷6	220	42	4	88,00	1	016024005

1682HS

Flexibele linialen vervaardigd uit roestvast staal H-SAFE

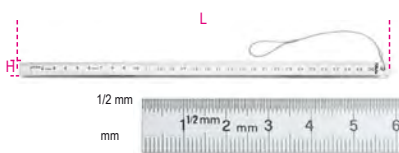

L	H	±	€		
mm	mm	mm			
200	13	0,5	21,20	1	016824020
300	13	0,5	23,50	1	016824030

1692HS

Rolbandmaten, schokbestendig ABS huis uit bi-materiaal, stalen meetlint, precisie klasse II H-SAFE



L	S	€		
m	mm			
3	16	26,50	1	016924053
5	19	32,00	1	016924055

1708HS/20

Voelermaten metrisch H-SAFE



S	S	L	€		
mm	mm	mm			
0,05±1,0	0,002±0,040	105	30,00	1	017084020

1727HS

Zaagbeugel, zware uitvoering H-SAFE

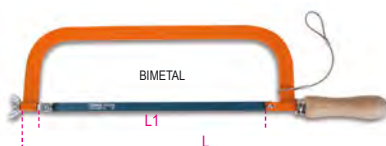

L	L1	€		
mm	mm			
515	300	42,50	1	017274001

1743HS

Bindstriptang voor Nylon bindstrips H-SAFE

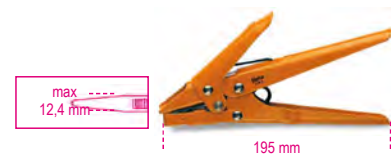

L	A	B	€		
mm	mm	mm			
195	85	17	83,00	1	017434001

1750HS

Vetspuit H-SAFE



1 g, 550 bar Max

cc	L	€		
	mm			
500	380	69,00	1	017504500

1760BHS

Digitale multimeter H-SAFE



SPECIFICATIE

DC spanning: 200 mV-2/20/200/1000V
 AC spanning: 2-20/200/700V
 DC ampere: 2/20/200 mA-20 A
 AC ampere: 2/200 mA- 20 A
 Weerstand: 200Ω - 2/20/200 kΩ - 2/20 MΩ
 Capaciteit: 2/20/200 nF - 2/200 μF
 Temperatuur: -20° + 1000°C/-4 °F ~ +2000°F
 Frequentie: 20kHz
 Voeding: 1.9V batterij (meegeleverd)

1760BHS	€		
	284,00	1	017604012

1772H-HS

Universeel mes met uitschuifbaar lemmet, geleverd met extra messen H-SAFE



L mm	A mm	€		
170	18	36,00	1	017724029

1778SOS-HS

Klapmes, met ramenbreker en gordelsnijder. In etui. H-SAFE



L mm	A mm	L1 mm	€		
205	25	85	56,00	1	017784080

8871

Veiligheidsriem met metalen gesp met dubbele sluiting



	L cm min-max	€		
8871 70	70-100	173,00	1	088710070
8871 100	100-135	185,50	1	088710100

8872A

Koordhouder

• Voor riem 8871



8872A 50	€		
	30,00	1	088720050

8872AS

Lus met klittenbandsluiting

• Voor riem 8871



8872AS 25	D mm	€		
	25	27,50	1	088720525

8873

Gereedschapszak met automatische sluiting en ritssluiting

• Voor riem 8871



8873 230	€		
	147,00	1	088730230

8877

Rekbaar veiligheidskoord

• MAX 2.7 kg



	L cm min+max	DxL mm	€		
8877 80	70-110	40x80	36,50	1	088770080

8877M

Rekbaar veiligheidskoord

• Met verdraaiingsvrije koppeling • MAX 2.7 kg



	L cm min+max	DxL mm	€		
8877M 20-140	20-140	30x60	67,50	1	088770510

8879

Polsband met klittenbandsluiting

• MAX 2.7 kg



8879	D mm	€		
	30	42,00	1	088790025

8880

Vaste verbindingsriem

• Met verdraaiingsvrije koppeling



	L Cm	D mm	€		
8880 30	30	10	32,50	1	088800030

8883

Gereedschapszak

• Van slijtvast nylon 840 • MAX 20 kg • Met musketon om de geslotenritssluiting te vergrendelen • 6 gereedschapshouders • Met binnenvak



	DxH cm	€		
8883	30x40	363,00	1	088830030





GEREEDSCHAPPEN VERVAARDIGD UIT ROESTVAST STAAL



De BETA INOX gereedschappen zijn te gebruiken in een specifieke omgeving - dat is, in ruimte waar zelfs het minimum aan vervuiling niet is toegestaan.

Zoals bijvoorbeeld bij:

- Nucleaire toepassingen
- Farmaceutische productie -
- Offshore werkzaamheden
- In bio-technologische en bio-medische laboratoria
- Voedsel verwerkende industrie.

De Beta Inox gereedschappen voorkomen een on gepaste roestvorming.

Telkens als er gereedschap gebruikt wordt, welke niet vervaardigd is uit roestvast staal, kunnen op roestvast stalen schroeven, moeren of oppervlakten kleine splinters komen van de gereedschappen waarmee roestvorming kan ontstaan. Met vaak als resultaat een esthetisch probleem, en soms eveneens een constructie probleem.

Voorbeelden van toepassing zijn:

- Scheepswerven
- Bouw
- Zonne-energie systemen
- Automobiël industrie.

KENMERKEN

Een nauwkeurige selectie van materialen en een gedegen onderzoek naar de beste hittebehandeling geven de Beta Inox gereedschappen, gecombineerd met mechanische



STAINLESS STEEL
+ NO STAINLESS
STEEL= RUST



STAINLESS STEEL
+ STAINLESS
STEEL= NO RUST

eigenschappen, een kwaliteit ver boven de standaard norm en die vergelijkbaar is met andere Beta gereedschappen. Deze gereedschappen delen dezelfde ergonomische eigenschappen en design als de andere Beta gereedschappen, welke bekend zijn en gewaardeerd worden door professionele gebruikers al meer dan 75 jaar.

Roestvast staal is **100% herbruikbaar**, wat een belangrijk pluspunt is.



Log voor roestvaststalen producten
Het logo is uitgegeven door het Centro Inox - de Italiaanse organisatie voor ontwikkeling van roestvast staal, welke de producten die gemaakt zijn van roestvast staal verbetert.

34INOX

Koudbeitels, vervaardigd uit roestvast staal



L mm	A mm	Ø mm	€	🔧	📄
160	18	18	48,00	1	000340318
200	20	20	70,00	1	000340320

39INOX

Wiggen, vervaardigd uit roestvast staal



L mm	A mm	S mm	€	🔧	📄
100	50	10	33,00	1	000390310
150	50	13	59,50	1	000390315
200	40	40	176,00	1	000390320

42INOX

Ringsteeksleutels vervaardigd uit roestvaststaal



DIN 3113 - UNI ISO 7738

Ø mm	L mm	€	🔧	📄
6x6	95	17,00	2	000420306
7x7	105	18,00	2	000420307
8x8	116	18,30	2	000420308
9x9	127	19,90	2	000420309
10x10	137	21,40	2	000420310
11x11	148	22,80	2	000420311
12x12	158	23,50	2	000420312
13x13	169	23,80	2	000420313
14x14	180	24,70	2	000420314
15x15	190	26,00	2	000420315
16x16	201	26,50	2	000420316
17x17	212	29,50	2	000420317
18x18	222	32,00	2	000420318
19x19	233	34,50	2	000420319
21x21	254	41,50	1	000420321
22x22	264	43,50	1	000420322
24x24	285	47,50	1	000420324
27x27	290	133,50	1	000420327
30x30	320	162,50	1	000420330
32x32	340	176,50	1	000420332
36x36	360	248,50	1	000420336
38x38	430	264,00	1	000420338
41x41	430	311,00	1	000420341
46x46	480	361,00	1	000420343
50x50	520	385,00	1	000420345
55x55	560	419,00	1	000420347
60x60	595	467,00	1	000420350



42INOX/S11	268,00	1	000420391
6-8-10-11-12-13-14-15-16-17-19 mm			



42INOX/SC9	234,00	1	000420387
8-10-11-12-13-14-15-17-19 mm			
42INOX/SCV9	11,50	1	000420303

42INOX-AS

Ringsteeksleutels, vervaardigd uit roestvast staal



Ø mm	L mm	€	🔧	📄
1/4x1/4	95	20,70	1	000420356
5/16x5/16	116	22,20	1	000420358
3/8x3/8	137	26,50	1	000420360
7/16x7/16	148	28,50	1	000420361
1/2x1/2	169	29,50	1	000420363
9/16x9/16	180	32,50	1	000420364
5/8x5/8	201	33,00	1	000420366
11/16x11/16	212	38,50	1	000420367
3/4x3/4	233	43,50	1	000420369
13/16x13/16	254	47,50	1	000420371
7/8x7/8	264	50,50	1	000420372
15/16x15/16	285	57,50	1	000420373



42INOX-AS/S9	275,00	1	000420396
1/4-5/16-3/8-7/16-1/2-9/16-5/8-11/16-3/4			



96BPINOX

Haakse stiftsleutels met kogelkop, vervaardigd uit roestvast staal



mm	L mm	L1 mm	Ø mm	g	€	🔧	📄
2	91	22	4		6,50	4	000961441
2,5	91	22	6		6,50	4	000961442
3	101	24	11		6,85	4	000961443
4	112	29	19		7,65	4	000961444
5	131	33	32		9,10	4	000961445
6	154	36	51		10,20	4	000961446
7	164	40	65		13,20	2	000961447
8	175	44	116		15,80	2	000961448
10	197	51	189		20,20	2	000961450



96BPINOX/B6	64,50	1	000961455
2,5-3-4-5-6-8 mm			
96BPINOX/B9	104,00	1	000961456
2-2,5-3-4-5-6-7-8-10 mm			
96BPINOX/BV	8,20	1	000961459

96BPINOX-AS

Haakse zeskant stiftsleutels met kogelkop, vervaardigd uit roestvast staal



"	L mm	L1 mm	Ø mm	g	€	🔧	📄
5/64	91	22	5,5		8,05	4	000961989
3/32	91	22	5,3		8,20	4	000961990
7/64	101	24	10,5		8,40	4	000961991
1/8	101	24	10,7		8,50	4	000961992
9/64	112	29	18,7		9,20	4	000961993
5/32	112	29	18,7		9,30	4	000961994
3/16	131	33	31,5		12,20	2	000961995
7/32	154	36	50,0		12,60	2	000961996
1/4	164	40	70,0		13,90	2	000961997
5/16	175	44	115,0		18,40	2	000961998
3/8	197	51	186,5		21,70	2	000961999



96BPINOX-AS/B8	99,50	1	000962000
5/64-3/32-1/8-5/32-3/16-7/32-1/4-5/16			
96BPINOX/BV	8,20	1	000961459

96TINOX

Haakse stiftsleutels met krachthandgreep, vervaardigd uit roestvast staal

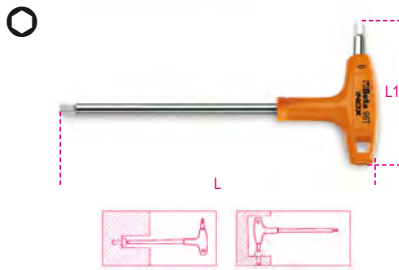

mm	L mm	L1 mm	€	Hand icon	Computer icon
2,5	153	55	14,50	2	000961935
3	153	55	15,50	2	000961936
4	179	70	16,30	2	000961938
5	200	84	17,60	2	000961940
6	221	95	20,10	2	000961941
7	236	106	24,20	2	000961942
8	255	117	28,50	2	000961943
10	285	132	36,50	2	000961944



96TINOX/S5 2,5-3-4-5-6 mm	€ 84,00	1	000961952
96TINOX/S8 2,5-3-4-5-6-7-8-10 mm	€ 173,00	1	000961954

96TINOX-AS

Haakse zeskant stiftsleutels, met kunststof krachthandgreep, vervaardigd uit roestvast staal

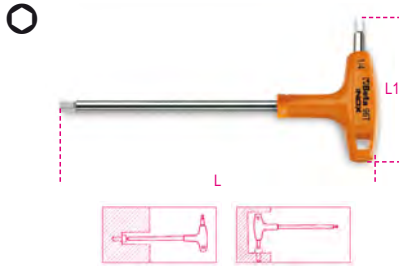

"	L mm	L1 mm	Ø mm	€	Hand icon	Computer icon
3/32	153	55	3	16,10	2	000961861
7/64	153	55	4	17,00	2	000961862
1/8	179	70	4	19,10	2	000961863
9/64	179	70	5	19,70	2	000961864
5/32	200	84	6	21,70	2	000961865
3/16	200	84	6	23,10	2	000961866
7/32	221	103	7	26,00	2	000961867
1/4	236	106	8	26,50	2	000961868
5/16	255	117	10	33,00	2	000961869
3/8	285	132	12	36,00	2	000961870



96TINOX-AS/S7 3/32-1/8-5/32-3/16-7/32-1/4-5/16	€ 165,50	1	000961877
---	----------	---	-----------

111INOX

Verstelbare moersleutels, vervaardigd uit roestvaststaal



DIN 3117 - ISO 6787

L mm	L" mm	A max mm	A1 mm	€	Hand icon	Computer icon
150	6	18	45	109,50	1	001110315
200	8	24	58	137,00	1	001110320
250	10	30	70	168,50	1	001110325

362INOX

Pijpentangen, zware uitvoering, vervaardigd uit roestvast staal



L mm	Ø max mm	€	Hand icon	Computer icon
300	58	240,00	1	003620430

920INOX-A

Zeskant dopsleutels, vervaardigd uit roestvast staal



DIN 3124 - UNI ISO 2725

Ø mm	Ø mm	A mm	L mm	€	Hand icon	Computer icon
8	15	10	40	36,00	2	009203008
9	16	10	40	38,00	2	009203009
10	17	10	40	39,50	2	009203010
11	18	11	40	41,50	2	009203011
12	19	11	40	44,00	2	009203012
13	20	11	40	47,00	2	009203013
14	21	11	40	49,00	2	009203014
15	23	11	40	51,50	2	009203015
16	24	11	40	54,50	2	009203016
17	25	11	40	55,50	2	009203017
18	26	13	42	57,50	2	009203018
19	28	13	42	59,50	2	009203019
20	29	13	42	63,50	1	009203020
21	30	13	43	64,50	1	009203021
22	31	15	43	65,00	1	009203022
24	34	15	43	76,00	1	009203024
27	38	18	46	93,00	1	009203027
30	42	20	46	110,00	1	009203030
32	44	20	46	124,50	1	009203032

920/55INOX

1/2" omschakelbare ratel, 72 tands, vervaardigd uit roestvast staal



L mm	Ø mm	A mm	€	Hand icon	Computer icon
264	40	43	274,00	1	009203882

920/R55INOX



920/R55 INOX	€ 99,00	1	009203879
--------------	---------	---	-----------

1048INOX

Waterpomptangen, doorgestoken scharnier, vervaardigd uit roestvaststaal
• 7-positie instelling

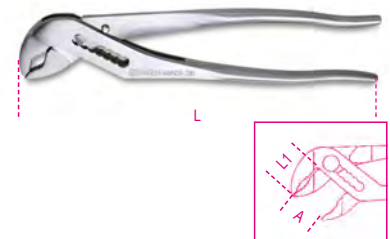

L mm	A max mm	L1 mm	€	Hand icon	Computer icon
250	33	33	169,50	1	010480325

1082INOX

Zijkniptangen, diagonaal, vervaardigd uit roestvast staal



L mm	L1 mm	mm	€	Hand icon	Computer icon
150	20,0	1,6	122,50	1	010820350

1150INOX

Industriële combinatietangen, vervaardigd uit roestvast staal

Decentraal scharnierpunt
Open scharnier constructie



L mm	L1 mm	€	Hand icon	Computer icon
180	39	120,00	1	011500518



1153INOX

Verstelbare tang, twee posities, vervaardigd uit roestvaststaal



L mm	L1 mm	€	🔧	📦
150	26	117,50	1	011530315

1290INOX

Schroevendraaiers voor sleutelschroeven, vervaardigd uit roestvaststaal

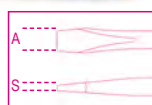

ISO 2380

SxAxL mm	L1 mm	Ø mm	€	🔧	📦
0,4x2,5x50	146	2.5	10,20	4	012900403
0,5x3x75	171	3.0	10,40	4	012900409
0,8x4x100	196	4.0	11,00	4	012900430
1,0x5,5x150	259	5.0	13,80	4	012900442
1,2x6,5x150	270	6.0	15,90	4	012900451

1292INOX

Schroevendraaier voor kruiskopschroeven met Phillips® profiel, vervaardigd uit roestvaststaal



ISO 8764

PHxDxL mm	L1 mm	€	🔧	📦
0x3x60	156	9,60	4	012920403
1x4,5x80	189	11,40	4	012920409
2x6x100	220	13,80	4	012920418

1293INOX/D8

Schroevendraaierset, vervaardigd uit roestvaststaal



1293INOX/D8	€	🔧	📦
1290INOX	96,00	1	012930408
1292INOX			

1370INOX

Bankhamer, vervaardigd uit roestvaststaal



g	A mm	L mm	L1 mm	€	🔧	📦
500	25	240	101	115,50	1	013700375

1377INOX

Bolbankhamers, ronde koppen, voor koper en tinsmederijen, vervaardigd uit roestvast staal



g	L mm	L1 mm	€	🔧	📦
230	220	82	68,00	1	013770623
340	220	90	98,00	1	013770634

1730INOX

Universele spatel, vervaardigd uit roestvast staal



A mm	L mm	€	🔧	📦
50	200	63,00	1	017300450

C20TSS

Gereedschapskist uitklapbaar, vijfdelig, vervaardigd uit AISI 304 roestvast staal



C20TSS	€	🔧	📦
	299,00	1	021203001

📏: 450x200x210 mm - 📊 4kg

T23



T23	549
TV23	549

T99



T99	552
TV99	552

T228



T228	556
TV180	555-556

Beta

Beta

C04TSS-7

Gereedschapswagen met zeven laden, volledig vervaardigd uit roestvast staal, Streep vrij wielen

Belangrijkste kenmerken:

- Zeven laden (570 x 410 mm) met kogellager geleiding;
- 6 laden, 83 mm hoog;
- 1 lade, 170 mm hoog;
- 4 wielen Ø 125 mm 2 vaste en 2 zwenkwielen (twee met rem);
- Centraal veiligheidsslot voorzijde;
- Gehele constructie vervaardigd uit roestvast staal
- Wielen, geleiders, lagers en laden zijn vervaardigd uit roestvast staal
- Laden handgrepen zijn vervaardigd uit aluminium

63 kg

Beta
NOX
STAINLESS STEEL

700
kg

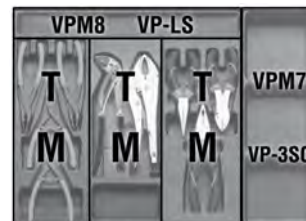

h	max
83 mm	25 kg
170 mm	30 kg

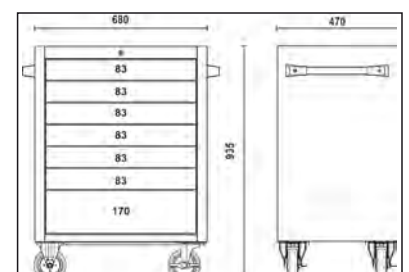
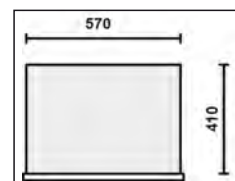

C04TSS/7

€ 2.900,00 1 024003077



Koper-Berillium Cu-Be

De **Beta** vonkvrije gereedschappen zijn specifiek ontworpen voor het veilig werken in een omgeving waar het risico bestaat van explosie, door het aanwezig zijn van ontvlambare vloeistoffen of gasen of voor werkzaamheden waar volledig anti magnetische en roestvrije gereedschappen noodzakelijk zijn.



De Beta vonkvrije gereedschappen zijn gecertificeerd door het Federale instituut voor Materiaal Onderzoek en Test BAM, conform de Europese richtlijnen 99/92/EC.



WAARSCHUWING!

Het risico van explosie in de nabijheid van **ACETYLEEN**

De mechanische kenmerken van de vonkvrije gereedschappen verschillen met die van de standaard stalen gereedschappen. Vonkvrije gereedschappen moeten zeer zorgvuldig gebruikt worden om overbelasting te voorkomen.

CLASSIFICATIE VAN OMGEVINGS RUIMTE MET EEN EXPLOSIE RISICO

ATEX	CLASSIFICATIE VAN OMGEVINGS RUIMTE MET EEN EXPLOSIE RISICO	
	MEDIUM-LAAG	EXTREEM LAAG
GAS	ZONE 1 Is een ruimte, waar de kans op een explosiegevoelige atmosfeer aanwezig is vanwege een brandbaar mengsel van lucht en brandbare stoffen in de vorm van gas, nevel of stof en kan ontstaan tijdens normale werkzaamheden.	ZONE 2 Is een ruimte, waar de kans op een explosiegevoelige atmosfeer aanwezig is vanwege een mengsel van lucht en brandbare stoffen in vorm van gas, nevel of stof welke normaal niet ontstaat bij dagelijkse werkzaamheden, maar als het zich voordoet, slechts kortstondig aanwezig is.
	ZONE 21 Is een ruimte, waar de kans op een explosiegevoelig atmosfeer aanwezig is in vorm van een ontvlambare stofwolk welke mogelijk kan ontstaan bij normale werkzaamheden.	ZONE 22 Is een ruimte, waar de kans op een explosiegevoelige atmosfeer aanwezig is in vorm van een ontvlambare stofwolk welke normaal niet ontstaat bij dagelijkse werkzaamheden, maar als het zich voordoet, slechts kortstondig aanwezig is.

30BA

Vonkvrije doorslagen



Ø mm	L mm	S mm	€	Hand	Icon
5	150	15	80,50	1	000300806
8	150	17	98,00	1	000300808
10	150	19	121,00	1	000300810

31BA

Vonkvrije pendrijvers



Ø mm	L mm	€	Hand	Icon
3	110	34,00	1	000310853
4	110	74,50	1	000310854
6	115	113,00	1	000310856
8	120	129,50	1	000310858

31BA/C

Vonkvrije conische doorslagen



Ø mm	Ø1 mm	L mm	€	Hand	Icon
*6	12	150	47,00	1	000310876
*7	13	150	54,50	1	000310877
*12	18	175	113,00	1	000310882
*13	29	255	352,00	1	000310883

32BA

Vonkvrije centerpunt



Ø mm	L mm	€	Hand	Icon
14	150	103,50	1	000320811

34BA

Vonkvrije koudbeitels



L mm	A mm	€	Hand	Icon
200	22	151,50	1	000340801
250	24	250,00	1	000340803
300	25	338,00	1	000340802

39BA

Vonkvrije wiggen



L mm	A mm	€	🔧	📦
150	40	65,00	1	000390801
230	40	222,00	1	000390802
250	40	355,00	1	000390803

42BA

Vonkvrije ringsteeksleutels



🔧 mm	L mm	€	🔧	📦
6x6	105	69,50	1	000420806
7x7	105	79,00	1	000420807
8x8	120	86,50	1	000420808
9x9	120	99,00	1	000420809
10x10	135	107,00	1	000420810
11x11	135	116,50	1	000420811
12x12	150	125,50	1	000420812
13x13	150	129,50	1	000420813
14x14	175	136,00	1	000420814
15x15	175	144,00	1	000420815
16x16	195	148,00	1	000420816
17x17	200	155,50	1	000420817
18x18	215	165,00	1	000420818
19x19	220	173,00	1	000420819
20x20	230	184,00	1	000420820
21x21	240	199,50	1	000420821
22x22	250	207,00	1	000420822
24x24	268	238,00	1	000420824
26x26	290	276,00	1	000420826
27x27	290	325,00	1	000420827
28x28	290	395,00	1	000420828
30x30	313	399,00	1	000420830
32x32	333	432,00	1	000420832
34x34	360	481,00	1	000420834
35x35	360	534,00	1	000420835
36x36	355	561,00	1	000420836
38x38	430	597,00	1	000420838
41x41	430	703,00	1	000420841
46x46	480	797,00	1	000420846
50x50	520	845,00	1	000420850
55x55	560	926,00	1	000420855
60x60	580	986,00	1	000420860
*65x65	595	1.143,00	1	000420865
*70x70	630	1.265,00	1	000420870

42BA-AS

Vonkvrije ringsteeksleutels, in engelse maten



🔧	L mm	€	🔧	📦
9/32x9/32	120	74,00	1	000420946
5/16x5/16	120	74,00	1	000420947
11/32x11/32	135	93,50	1	000420948
3/8x3/8	128	98,00	1	000420950
7/16x7/16	135	113,00	1	000420951

🔧	L mm	€	🔧	📦
15/32x15/32	140	122,00	1	000420949
1/2x1/2	140	129,50	1	000420953
9/16x9/16	163	140,50	1	000420954
*19/32x19/32	195	168,50	1	000420955
5/8x5/8	177	170,50	1	000420956
11/16x11/16	195	182,00	1	000420957
3/4x3/4	215	187,00	1	000420959
13/16x13/16	230	219,00	1	000420961
7/8x7/8	235	225,50	1	000420962
15/16x15/16	256	253,00	1	000420964
*31/32x31/32	265	272,00	1	000420963
1x1	266	274,00	1	000420965
1.1/16x1.1/16	283	308,00	1	000420967
1.1/8x1.1/8	297	408,00	1	000420969
1.3/16x1.3/16	308	439,00	1	000420970
1.1/4x1.1/4	324	521,00	1	000420973
*1.7/16x1.7/16	360	602,00	1	000420976

55BA

Vonkvrije dubbele steeksleutels



🔧 mm	L mm	€	🔧	📦
6x7	90	48,50	1	000550801
8x9	100	52,00	1	000550802
8x10	100	53,00	1	000550795
9x11	110	58,50	1	000550797
10x11	120	61,50	1	000550803
12x13	130	75,00	1	000550804
*12x14	130	89,50	1	000550846
13x14	133	89,50	1	000550799
14x15	145	91,50	1	000550805
14x17	150	96,00	1	000550806
16x17	165	99,50	1	000550807
17x19	170	131,00	1	000550847
18x19	170	132,00	1	000550809
*19x22	185	152,00	1	000550810
20x22	185	153,00	1	000550811
21x23	210	165,00	1	000550813
22x24	210	199,00	1	000550815
24x26	230	234,50	1	000550817
24x27	230	248,50	1	000550818
25x28	230	270,00	1	000550819
27x29	246	321,00	1	000550820
30x32	265	373,00	1	000550822
36x38	320	474,00	1	000550826
36x41	335	507,00	1	000550828
41x46	355	630,00	1	000550829
*46x50	370	723,00	1	000550830
*50x55	385	777,00	1	000550831
*55x60	415	975,00	1	000550832

55BA-AS

Vonkvrije dubbele steeksleutels in engelse maten



🔧	L mm	€	🔧	📦
3/8x7/16	110	63,00	1	000550853
1/2x9/16	130	74,50	1	000550854
5/8x11/16	160	111,50	1	000550857
3/4x13/16	180	139,00	1	000550859
7/8x15/16	210	193,50	1	000550865
1x1.1/16	230	258,00	1	000550868
1.1/8x1.3/16	245	344,00	1	000550870
1.1/4x1.5/16	255	399,00	1	000550872

58BA

Vonkvrije slagsteeksleutels



🔧 mm	L mm	€	🔧	📦
17	125	130,00	1	000580817
19	125	134,50	1	000580819
22	135	136,50	1	000580822
24	150	152,50	1	000580824
27	165	182,50	1	000580827
30	180	231,00	1	000580830
32	190	271,00	1	000580832
*34	200	314,00	1	000580834
36	210	324,00	1	000580836
38	220	350,00	1	000580838
41	230	396,00	1	000580841
46	240	470,00	1	000580846
50	255	527,00	1	000580850
*55	305	663,00	1	000580855
*60	315	757,00	1	000580860
*65	335	906,00	1	000580865
*70	370	1.095,00	1	000580870
*75	375	1.275,00	1	000580875
*80	400	1.525,00	1	000580880
*85	400	1.660,00	1	000580885
*90	445	1.955,00	1	000580890
*95	445	2.250,00	1	000580895
*100	485	2.650,00	1	000580900
*110	513	3.180,00	1	000580901

58BA-AS



🔧 mm	L mm	A mm	S mm	€	🔧	📦
*11/16	125	40,5	11,0	129,00	1	000580904
*3/4	125	40,5	11,0	131,00	1	000580905
*7/8	135	46,2	12,0	134,50	1	000580906
*15/16	150	50,3	12,0	154,50	1	000580907
*31/32	150	50,3	12,0	172,50	1	000580954
*1	175	56,9	15,0	175,00	1	000580908
*1.1/8	190	64,0	15,5	229,00	1	000580909
*1.1/4	190	64,0	15,5	272,00	1	000580910
*1.7/16	210	75,0	18,5	313,00	1	000580912
*1.1/2	220	82,0	18,5	364,00	1	000580913
*1.5/8	230	86,8	18,5	397,00	1	000580914
*1.3/4	250	98,0	20,	499,00	1	000580970

78BA

Vonkvrije twaalfkantig slaggringsleutels



🔧 mm	L mm	€	🔧	📦
17	145	132,50	1	000780817
19	145	144,50	1	000780819
22	165	146,50	1	000780822
24	140	182,00	1	000780824
27	155	206,00	1	000780827
30	165	239,50	1	000780830
32	180	257,00	1	000780832
34	192	291,00	1	000780834
36	208	318,00	1	000780836
38	215	371,00	1	000780838
41	225	433,00	1	000780841
46	245	486,00	1	000780846
50	250	554,00	1	000780850

mm	L mm	€		
55	265	658,00	1	000780855
60	275	696,00	1	000780860
65	295	771,00	1	000780865
70	310	854,00	1	000780870
75	325	960,00	1	000780875
80	340	1.029,00	1	000780880
*85	355	1.305,00	1	000780885
*90	380	1.520,00	1	000780890
*95	390	1.750,00	1	000780895
*100	410	2.000,00	1	000780900
*105	420	2.165,00	1	000780903
*110	445	2.430,00	1	000780901
*120	480	3.000,00	1	000780902

78BA-AS

Vonkvrije ringslagsleutels in engelse maten



mm	L mm	€		
11/16	145	131,50	1	000780908
3/4	145	137,00	1	000780909
7/8	155	155,00	1	000780935
15/16	165	168,50	1	000780936
*31/32	165	199,00	1	000780937
1	175	202,50	1	000780938
*1.1/16	175	229,00	1	000780939
1.1/8	180	235,00	1	000780940
1.3/16	185	243,00	1	000780941
1.1/4	177	273,00	1	000780910
*1.5/16	200	275,00	1	000780954
*1.3/8	205	292,00	1	000780911
1.7/16	208	367,00	1	000780912
*1.1/2	215	386,00	1	000780913
*1.9/16	225	439,00	1	000780947
*1.11/16	225	462,00	1	000780962
1.5/8	225	453,00	1	000780914
*1.3/4	235	486,00	1	000780963
1.13/16	243	524,00	1	000780916
1.7/8	235	553,00	1	000780915
2	254	615,00	1	000780918
2.3/16	264	716,00	1	000780920
2.3/8	275	786,00	1	000780922
*2.9/16	286	807,00	1	000780924
*2.15/16	311	999,00	1	000780926
*3.1/8	325	1.129,00	1	000780928
*3.1/2	355	1.450,00	1	000780930

89BA

Vonkvrije enkelvoudige ringsleutels



mm	L mm	€		
10	200	152,00	1	000890810
11	210	156,50	1	000890811
12	220	161,00	1	000890812
13	230	164,00	1	000890813
14	240	167,00	1	000890814
16	260	178,50	1	000890816
17	270	189,00	1	000890817
18	280	200,50	1	000890818
19	300	209,00	1	000890819
20	310	250,00	1	000890820
22	330	257,00	1	000890822
24	350	282,00	1	000890824
27	370	348,00	1	000890827
30	400	385,00	1	000890830
32	420	412,00	1	000890832

90BA

Vonkvrije gebogen ringsleutels



mm	L mm	€		
6x7	122	51,00	1	000900801
8x9	128	64,50	1	000900802
10x11	155	72,00	1	000900803
12x13	175	86,00	1	000900806
12x14	180	92,50	1	000900807
14x15	200	108,00	1	000900808
14x17	220	109,50	1	000900809
16x17	230	124,50	1	000900811
16x18	235	126,50	1	000900812
17x19	250	127,00	1	000900814
18x19	265	142,00	1	000900815
19x22	280	146,50	1	000900817
20x22	295	166,50	1	000900818
21x23	298	181,50	1	000900820
22x24	315	214,50	1	000900821
24x26	333	282,00	1	000900822
24x27	340	285,00	1	000900823
30x32	395	397,00	1	000900824
34x36	410	563,00	1	000900826
*36x41	450	758,00	1	000900828
*41x46	470	947,00	1	000900829
*46x50	490	1.054,00	1	000900830

91BA

Vonkvrije gebogen opzet ringsleutels



mm	Ø mm	€		
24	38	326,00	1	000910824
27	42	351,00	1	000910827
30	48	402,00	1	000910830
32	49	451,00	1	000910832
36	54	491,00	1	000910836
41	62	549,00	1	000910841
*46	69	723,00	1	000910846
*50	75	777,00	1	000910850
*55	82	858,00	1	000910855

92BA

Vonkvrije handgreep voor opzetstukken 91BA



	L mm	91BA mm	Ø mm	€		
92BA/1	460	24÷30	25	385,00	1	000920810
92BA/2	610	32÷41	28	494,00	1	000920820
*92BA/3	760	46÷55	32	666,00	1	000920830

93BA

Vonkvrije dubbele dopratelsleutel voor draadeind moeren



mm	L mm	€		
21x22	345	786,00	1	000930821

95BA

Vonkvrije platte ringsleutels



mm	L mm	€		
7x9	115	50,50	1	000950801
8x10	115	56,00	1	000950802
10x11	140	61,50	1	000950804
10x12	140	70,00	1	000950805
12x14	145	82,50	1	000950806
14x17	165	99,00	1	000950807
*16x18	170	128,00	1	000950809
*17x19	185	111,50	1	000950808
*18x19	185	140,00	1	000950810
*19x22	200	174,50	1	000950812
*21x23	230	188,00	1	000950815
*24x27	255	241,50	1	000950817
*30x32	295	365,00	1	000950820

96BA

Vonkvrije haakse stiftsleutels



mm	L mm	L1 mm	€		
1,5	50	17	100,50	1	000960760
2	50	16	103,50	1	000960762
2,5	56	20	111,00	1	000960761
3	63	21	113,00	1	000960763
4	69	25	116,00	1	000960764
5	78	29	118,00	1	000960765
6	88	33	122,00	1	000960766
7	93	34	128,50	1	000960767
8	97	36	133,50	1	000960768
9	104	37	140,00	1	000960769
10	110	39	144,50	1	000960770
11	118	42	153,50	1	000960771
12	122	44	167,50	1	000960772
14	150	58	195,50	1	000960774
15	156	60	206,00	1	000960775
16	162	63	226,50	1	000960776
17	168	65	237,00	1	000960777
19	177	72	265,00	1	000960779
22	186	77	312,00	1	000960802
24	192	82	360,00	1	000960804

96BA/BP

Ball head offset hexagon key wrenches, sparkproof



mm	L mm	L1 mm	€		
1,5	50	16	98,00	1	000961800
2	50	16	99,00	1	000961801
2,5	63	20	111,00	1	000961802
3	60	20	112,00	1	000961803
3,5	70	25	116,00	1	000961799
4	66	25	118,00	1	000961804
5	75	28	120,00	1	000961805
6	84	32	122,00	1	000961806
8	92	36	133,50	1	000961808
10	102	40	144,00	1	000961810
12	113	45	179,00	1	000961812

96BAF-AS

Vonkvrije haakse stiftsleutels



mm	L mm	L1 mm	€		
*1/16	59	25	75,50	1	000962831
*5/64	59	25	78,50	1	000962832
*3/32	59	25	83,00	1	000962833
*7/64	59	25	86,50	1	000962834
*1/8	59	25	89,50	1	000962835
*9/64	64	29	96,50	1	000962836
*5/32	65	30	100,00	1	000962837
*3/16	79	31	105,50	1	000962838
*7/32	85	37	109,50	1	000962839
*1/4	85	37	114,50	1	000962840
9/32	88	38	120,50	1	000962841
*5/16	92	44	123,50	1	000962842
11/32	100	44	129,00	1	000962843
*3/8	110	45	134,00	1	000962844
*7/16	119	48	143,50	1	000962845
*1/2	140	55	177,50	1	000962846
*9/16	150	58	202,50	1	000962847

99BA

Vonkvrije haaksleutels met vierkant neusstuk voor ringmoeren UNI/ISO 2982, 2983



mm	A mm	€		
32-75	4,0	263,00	1	000990803
50-120	4,5	400,00	1	000990805
115-170	4,5	663,00	1	000990811

110BA

Vonkvrije verstelbare moersleutels



L mm	A max mm	€		
100	13	200,00	1	001100810
150	18	219,00	1	001100815
200	24	264,00	1	001100820
250	30	318,00	1	001100825
300	36	448,00	1	001100830
375	46	604,00	1	001100837
*450	55	818,00	1	001100845
*600	65	1.365,00	1	001100860

330BA

Vonkvrije pijpsnijders voor gaspijpen



330BA/2	Ø max 50 mm	L mm	€		
	2"	375	1.014,00	1	003300802

330BA/2R

Reserve pen en mes voor pijpsnijder 330BA, vonkvrij



330BA /2-R	€		
	100,00	1	003300822

363BA

Vonkvrije zware pijpentangen



L mm	Ø max 1/2" gas	Ø max mm	€		
150	20	20	325,00	1	003630815
200	30	30	332,00	1	003630820
250	49	49	379,00	1	003630825
300	60	60	475,00	1	003630830
350	60	60	598,00	1	003630835
450	76	76	912,00	1	003630845
600	90	90	1.280,00	1	003630860

378BA

Vonkvrije pijpentang, Zweeds model, vervaardigd uit koper/beryllium legering



L mm	Ø max 1" 1/2 gas	€		
430	960,00	1	003780800	
530	1.182,00	1	003780801	

386BA

Vonkvrije zware en omkeerbare kettingtangen

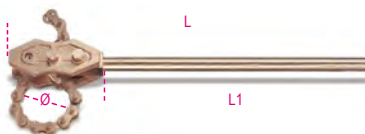

L mm	Ø max mm	L1 mm	€		
600	100	470	1.475,00	1	003860806
900	200	750	2.455,00	1	003860809

911BA

Twaalfkant dopsleutels, vonkvrij

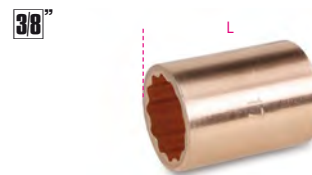

mm	L mm	€		
6	28	61,50	1	009110806
7	28	65,50	1	009110807
8	28	72,00	1	009110808
9	28	75,50	1	009110809
10	32	103,50	1	009110810
11	32	109,00	1	009110811
12	32	115,50	1	009110812
13	32	120,00	1	009110813
14	32	127,50	1	009110814
15	32	128,00	1	009110815
16	32	134,50	1	009110816
17	32	140,00	1	009110817
18	32	142,50	1	009110818
19	32 32	147,00	1	009110819

911BA/16

Verlooppop, 3/8" naar 1/2" aandrijf vierkant, vonkvrij

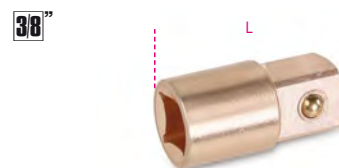

L mm	3/8"	1/2"	€		
34			130,50	1	009110836

911BA/20

Verlengstuk, 3/8" aandrijf vierkant, vonkvrij



L mm	€		
75	105,00	1	009110840

911BA/55

3/8" ratel met doorsteekvierkant, vonkvrij

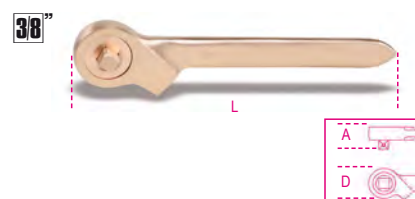

L mm	D mm	A mm	€		
200	45	16,5	218,50	1	009110882



921BA

Vonkvrije twaalfkant dopsleutels

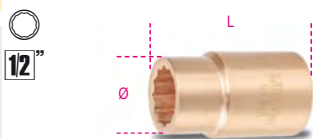

mm	Ø mm	L mm	€	1	009210808
8	15,0	40	93,00	1	009210808
9	16,0	40	97,00	1	009210809
10	17,5	40	111,00	1	009210810
11	18,0	40	114,50	1	009210811
12	18,5	40	122,00	1	009210812
13	20,0	40	129,50	1	009210813
14	21,0	40	131,50	1	009210814
15	21,5	40	135,50	1	009210815
16	24,0	40	142,50	1	009210816
17	25,0	40	147,00	1	009210817
18	25,0	40	152,50	1	009210818
19	28,0	42	156,50	1	009210819
20	29,0	42	164,00	1	009210820
21	30,0	43	167,50	1	009210821
22	30,5	43	174,00	1	009210822
24	34,0	43	204,00	1	009210824
25	36,0	43	223,50	1	009210825
26	37,5	43	237,00	1	009210826
27	37,5	45	249,50	1	009210827
28	38,9	46	260,00	1	009210828
30	41,5	46	292,00	1	009210830
32	43,5	46	325,00	1	009210832

921BA-AS

Vonkvrije twaalfkant dopsleutels

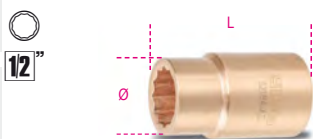

"	Ø mm	L mm	€	1	009210958
5/16	24,0	40	105,50	1	009210958
3/8	24,0	40	111,50	1	009210960
7/16	24,0	40	122,50	1	009210961
1/2	24,0	40	131,50	1	009210963
9/16	24,0	40	136,00	1	009210964
5/8	25,0	40	157,50	1	009210966
11/16	25,5	40	168,50	1	009210967
3/4	28,0	42	183,00	1	009210969
13/16	30,0	43	195,50	1	009210971
7/8	31,5	43	214,50	1	009210972
15/16	34,0	43	226,00	1	009210974
1	36,0	43	254,00	1	009210975
1.1/16	38,0	46	274,00	1	009210977
1.1/4	42,0	46	362,00	1	009210982
1.7/16	50,5	50	446,00	1	009210986

921BA/15

Verlooptop, van 1/2" naar 3/8", vonkvrij



L mm	1/2"	3/8"	€	1	009210839
34	1/2"	3/8"	116,50	1	009210839

921BA/16

Verlooptop van 1/2" naar 3/4" vonkvrij



L mm	1/2"	3/4"	€	1	009210840
34	1/2"	3/4"	152,50	1	009210840

921BA/21 - 921BA/22

Vonkvrije 1/2" verlengstukken



	L mm	Ø mm	€	1	009210842
921BA/21	125	30	159,00	1	009210842
921BA/22	250	31	223,00	1	009210844

921BA/25

Vonkvrije cardangewricht 1/2" aansluiting



L mm	Ø mm	1/2"	1/2"	€	1	009210845
80	25	1/2"	1/2"	175,00	1	009210845

921BA/42

Vonkvrije 1/2" wringstaaf met verschuifbaar vierkant



L mm	€	1	009210846
250	280,00	1	009210846

921BA/50

Vonkvrije 1/2" doorsteek ratelsleutel



L mm	D mm	A mm	€	1	009210850
250	45	16,5	292,00	1	009210850

921BA/R50

Vonkvrije reserve onderdelen ratelkop



1/2"	€	1	009210851
1/2"	86,00	1	009210851

926BA

Vonkvrije 1/2" twaalfkant dopsleutels

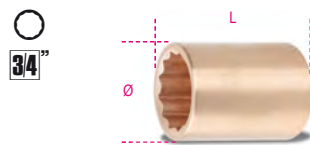

mm	Ø mm	L mm	€	1	009260822
22	40	55	210,00	1	009260822
24	40	55	241,00	1	009260824
26	40	55	274,00	1	009260826
27	40	55	290,00	1	009260827
28	41	55	332,00	1	009260828
30	43	60	338,00	1	009260830
32	45	60	383,00	1	009260832
34	48	60	410,00	1	009260834
36	50	60	444,00	1	009260836
38	53	60	471,00	1	009260838
41	57	65	519,00	1	009260841
46	63	65	610,00	1	009260846
50	68	70	669,00	1	009260850

926BA/15

Verlooptop van 3/4" naar 1/2" vonkvrij



L mm	3/4"	1/2"	€	1	009260861
55	3/4"	1/2"	152,50	1	009260861

926BA/22

Vonkvrije 3/4" verlengstukken



926BA/22	L mm	Ø mm	€	1	009260872
926BA/22	200	38	340,00	1	009260872

926BA/42

Vonkvrij wringstaaf met 3/4" verschuifbaar aandrijfvierkant



L mm	€	1	009260876
400	509,00	1	009260876

926BA/50

Vonkvrije 3/4" doorsteek ratel



L mm	D mm	A mm	€	Hand	Computer
300	61	22	500,00	1	009260880

926BA/R50

Vonkvrije reserve onderdelen ratelkop



3/4"	€	Hand	Computer
	163,00	1	009260881

937BA

Vonkvrije pijpsleutels



Ø mm	L mm	A mm	€	Hand	Computer
13	240	45	121,00	1	009370813
17	260	51	172,50	1	009370817
19	270	55	184,00	1	009370819
22	278	59	239,50	1	009370822
24	286	63	259,00	1	009370824
27	294	69	274,00	1	009370827
30	302	75	302,00	1	009370830
32	310	81	328,00	1	009370832
*36	330	85	385,00	1	009370836
*41	350	90	466,00	1	009370841

951BA

T-sleutel met zeskant profiel uiteinde, vonkvrij



mm	L mm	L1 mm	€	Hand	Computer
4	100	90	195,00	1	009510904
5	100	90	203,00	1	009510905
6	100	90	215,50	1	009510906

961BA

Vonkvrije koevoeten



L mm	A mm	€	Hand	Computer
250	39	182,50	1	009610802
350	55	271,00	1	009610806

963BA

Vonkvrije puntschop met puntige en gebogen platte uiteinden



L mm	A mm	€	Hand	Computer
500	24	484,00	1	009630801
*800	24	763,00	1	009630803
*1000	30	1.610,00	1	009630805

964BA

Vonkvrije vatensleutel



L mm	€	Hand	Computer
385	472,00	1	009640801

964BA/L

Vonkvrije universele vatensleutel

Voor het openen van vaten met een rand



*964BA/L	L mm	€	Hand	Computer
	510	2.295,00	1	009640821

965BA

Vonkvrije veiligheidsklepsleutel



A mm	A1 mm	L mm	€	Hand	Computer
30	44	200	201,00	1	009650830
32	50	300	278,00	1	009650832
35	47	250	223,50	1	009650835
40	50	300	260,00	1	009650840
45	58	350	342,00	1	009650845
48	62	375	356,00	1	009650848
50	67	400	391,00	1	009650850

A mm	A1 mm	L mm	€	Hand	Computer
55	73	450	468,00	1	009650855
60	79	500	502,00	1	009650860
*65	82	550	567,00	1	009650865
*70	85	600	630,00	1	009650870

966BA

Vonkvrije veiligheidsklep sleutel

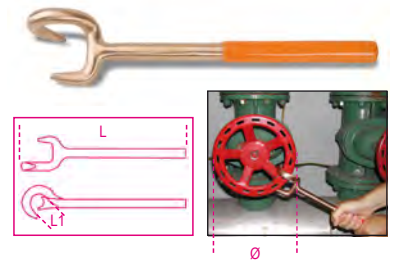

L mm	L1 mm	Ø min+max mm	€	Hand	Computer
350	40	50÷150	446,00	1	009660801

966BA/V

Vonkvrije veiligheidsklep sleutel

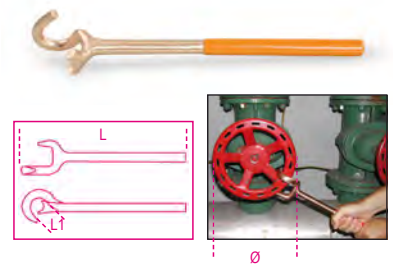

L mm	L1 mm	Ø min+max mm	€	Hand	Computer
370	36	125÷250	458,00	1	009660812
430	48	250÷400	650,00	1	009660814

1032BA

Vonkvrije borgveertang, rechte punten, PVC-handgreep



L mm	Ø mm	€	Hand	Computer
200	40÷100	293,00	1	010320820

1036BA

Vonkvrije borgveertangen, rechte uitwendige punten, PVC-handgrepen

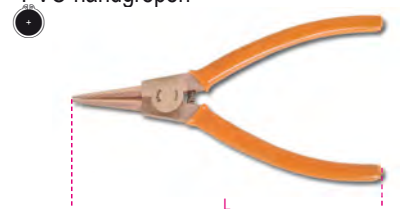

L mm	Ø mm	€	Hand	Computer
200	40÷100	293,00	1	010360820

1046BA

Vonkvrije waterpomptangen

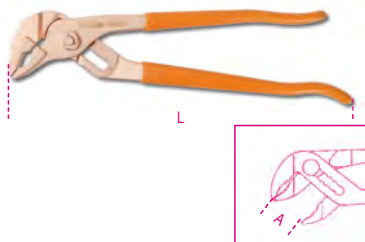

L mm	A max mm	€	🔧	📦
250	32	396,00	1	010460801
★300	52	507,00	1	010460803

1052BA

Instelbare griptangen,
halfronde beken, vonkvrij

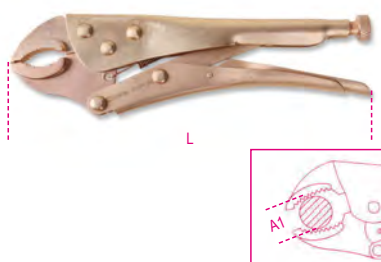

L mm	A1 max mm	€	🔧	📦
225	40,0	391,00	1	010520824

1082BA

Vonkvrije zijknijptangen

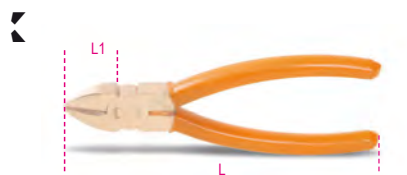

L mm	L1 mm	€	🔧	📦
160	22	278,00	1	010820801

1100BA

Boutenscharen,
vonkvrij



L mm	€	🔧	📦
600	1.825,00	1	011000860

1137BA

Lontentang



L mm	L1 mm	€	🔧	📦
185	30	521,00	1	011370801

1137BA/RC

Reserve mes voor item 1137BA



1137BA/RC	€	🔧	📦
	100,00	1	011370851

1150BA

Vonkvrije combinatietangen



L mm	L1 mm	€	🔧	📦
200	40	326,00	1	011500820

1162BA

Vonkvrije lange platte punttang met gegroefde beken



L mm	L1 mm	€	🔧	📦
150	54	267,00	1	011620815

1166BA

Vonkvrije lange ronde punttang met gegroefde beken



L mm	L1 mm	€	🔧	📦
150	54	267,00	1	011660815

1270BA

Vonkvrije schroevendraaiers voor sleuf
schroeven



AxL mm	L1 mm	€	🔧	📦
3x75	178	49,00	1	012700803
4x100	209	59,00	1	012700804
5x150	250	79,00	1	012700805
6x150	270	84,00	1	012700806
10x250	382	123,50	1	012700810
8x200	312	91,00	1	012700808

1272BA

Vonkvrije schroevendraaiers voor
kruiskopschroeven met Phillips® profiel



PHxDxL mm	L1 mm	€	🔧	📦
1x5x100	209	67,50	1	012720801
2x6x150	270	87,00	1	012720802
3x8x200	332	103,50	1	012720803

1277BA

Schroevendraaiers voor schroeven met Torx®
profiel, vonkvrij



Ø	L mm	L1 mm	Ø mm	€	🔧	📦
T10	75	184	5	60,00	1	012770810
T15	75	184	5	64,50	1	012770815
T20	100	209	6	84,50	1	012770820
T25	125	209	6	92,00	1	012770825
T30	150	270	6	101,50	1	012770830
T40	200	332	8	129,00	1	012770840

1370BA

Vonkvrije bankhamers met houten steel



g	A mm	L mm	L1 mm	€	🔧	📦
500	30	310	108	176,00	1	013700805
1000	35	340	137	309,00	1	013700810

1370BA/MR

Reserve stelen voor model 1370BA

	€		
1370BA/MR 500 1370BA/500	31,00	1	013700865
1370BA/MR 1000 1370BA/1000	37,00	1	013700870

1370BA/PL

Vonkvrije bankhamers,
kunststof steel



g	A mm	L mm	L1 mm	€		
500	30	310	108	176,00	1	013700815
1000	35	340	137	309,00	1	013700820

1375BA/PL

Vonkvrije penbank klauwhamer,
kunststof steel



g	L mm	L1 mm	Ø mm	€		
680	321	125	30	222,00	1	013750800

1377BA

Vonkvrije penbankhamers, ronde kop,
voor koper - en tinsmeders



g	L1 mm	L mm	€		
340	90	280	110,00	1	013770834

1377BA/PL

Vonkvrije bolbankhamers, ronde kop,
voor koper en tinsmeden



g	L1 mm	L mm	€		
340	90	280	110,00	1	013770884

1379BA

Vonkvrije lasbikhamer met houten steel



g	L1 mm	L mm	€		
500	142	315	224,00	1	013790850

1380BA

Vonkvrije vuist met houten steel



g	L1 mm	L mm	€		
1000	100	400	380,00	1	013800810
1500	118	400	457,00	1	013800815
2000	126	400	607,00	1	013800820

1380BA/MR

Reserve stelen voor model 1380BA

	€		
1380BA/MR 1000 1380BA/1000	38,00	1	013800860
1380BA/MR 1500 1380BA/1500	38,00	1	013800865
1380BA/MR 2000 1380BA/2000	38,00	1	013800870

1380BA/PL

Vonkvrije mokers,
kunststof steel



g	L1 mm	L mm	€		
500	80	310	189,00	1	013800955
1000	94	350	352,00	1	013800960
1500	115	400	493,00	1	013800965
2000	125,5	400	655,00	1	013800970

1381BA

Vonkvrije mokers, houten steel



g	L1 mm	L mm	€		
5000	179	900	1.450,00	1	013810850
*8000	190	900	2.285,00	1	013810858

1381BA/MR

Reserve steel voor model 1381BA

	€		
1381BA/MR 5000 1381BA/5000	60,50	1	013810870
*1381BA/MR 8000 1381BA/8000	67,00	1	013810878

1381BA/PL

Vonkvrije voorhamer,
kunststof steel



g	L1 mm	L mm	€		
5000	172	900	1.280,00	1	013810885
8000	204	900	2.295,00	1	013810888

1390BA

Vonkvrije kunststof hamer



Ø mm	L mm	L1 mm	€		
*52	370	130	313,00	1	013900805

1390BA/R

Reserve nylon hamerdoppen voor artikel
1390BA



D mm	€		
52	64,00	4	013900885



1602BA

Vonkvrije kabelschoentang
voor geïsoleerde kabelschoenen,
lichte uitvoering



mm ²	L mm	€	1	016020801
0.75+6	200	364,00	1	016020801

1701BA

Vonkvrije zeskant beitels



L mm	A mm	S mm	€	1	017010810
150	12	10	66,00	1	017010810
200	16	14	105,00	1	017010814
250	18	14	129,00	1	017010815
350	19	17	340,00	1	017010817

1703BA/A

Vonkvrije bijl



L mm	L1 mm	A mm	€	1	017030082
340	145	82	302,00	1	017030082

1703BA/P

Vonkvrije pikhouweel



A mm	L mm	L1 mm	€	1	017030150
56	1050	410	806,00	1	017030150

1703BA/PL

Vonkvrije schep



A mm	L1 mm	L mm	€	1	017030200
240	420	990	670,00	1	017030200

1717BA

Vonkvrije plamuurmessen



A mm	€	1	017170801
60	166,50	1	017170801
80	190,50	1	017170803

1717BA/1

Vonkvrije schraaper



A mm	L mm	€	1	017170805
100	220	330,00	1	017170805

1719BA8

Vonkvrije vijlen, 8"



	L mm	€	1	017190801
1719BA8/P	200	206,00	1	017190801
1719BA8/M	200	212,00	1	017190805
1719BA8/R	200	214,00	1	017190810
1719BA8/T	200	200,50	1	017190815
1719BA8/Q	200	200,50	1	017190820

1719BA12

Vonkvrije vijlen, 12"



	L mm	€	1	017190831
1719BA12/P	300	364,00	1	017190831

1727BA

Vonkvrije zaagbeugel met zaagblad



L mm	L1 mm	€	1	017270801
500	300	635,00	1	017270801

1728BA

Vonkvrije zagen
vervaardigd uit koper-beryllium legering.



L mm	€	1	017280801
300	121,50	1	017280801

1737BA

Vonkvrije draadborstel



L mm	A mm	€	1	017370801
294	29	82,00	1	017370801

1758BA

Vonkvrije trechter



Ø mm	H mm	€	1	017580815
160	150	121,50	1	017580815

1776BA

Vonkvrij mes



L1 mm	L mm	€	1	017760801
145	250	187,00	1	017760801

1784BA

Vonkvrije scharen



L mm	€	1	017840822
225	325,00	1	017840822





POWER TOOLS

Betrouwbare, duurzame gereedschappen die aan de eisen van elke professional kunnen voldoen.

De productfamilie Power Tools van Beta bestaat uit

ACCU GEREEDSCHAP

GEREEDSCHAP MET SNOER



ACCU GEREEDSCHAP



Het nieuwe assortiment accugereedschap omvat krachtige machines van 12 V en 20 V.

De 12V-lijn omvat de klopboormachine en de slagschroevendraaier, onmisbare gereedschappen die zijn ontworpen om het dagelijkse werk gemakkelijker te maken, gebaseerd op prestaties, lichtgewicht en compactheid.

Terwijl de 20V-lijn accugereedschappen omvat die synoniem staan voor hoge prestaties, kwaliteit en duurzaamheid.

Bij Beta vertrouwen we op deze kenmerken om een uitgebreid assortiment accugereedschappen te ontwikkelen, variërend van de klopboormachine met hoog koppel tot de slagmoersleutel met ½" aandrijfvierkant.

Alle nieuwe Power Tools van Beta zijn uitgerust met borstel loze motoren en eersteklas interne mechanismen, voor aanzienlijk verbeterde prestaties en duurzaamheid van het gereedschap.

De slagmoersleutel met een maximaal losdraaimoment van maar liefst 1200 Nm is zonder twijfel het vlaggenschip van de nieuwe serie, een ideale werkpartner voor iedereen die ongeëvenaarde kracht en prestaties nodig heeft.

Onze 20V lithium-ion accu's zijn verkrijgbaar met capaciteiten tot 6Ah en kunnen op alle gereedschappen uit het assortiment worden gebruikt.



Scan de QR-code en krijg meer informatie over onze 3 jaar garantie policy.

1972/K12V-10

ultracompacte boormachine, 12V

- UltraCompact: slechts 170 mm lang; Ultra licht in gewicht, niet meer dan 1,1 kg inclusief accu en perfect uitgebalanceerd
- Dubbele mechanische snelheid met stalen tandwielen en 20 mogelijke koppelinstellingen
- koppel tot 30 Nm en 1300 tpm (400 tpm in 1e versnelling); boor diameters tot 10 mm in staal en 20 mm in hout
- 2AH -batterijen en laadindicator op behuizing van de machine
- Ergonomische anti-slip handgreep
- LED licht voorzijde
- 10 mm snelspan boorhouder
- riemclip (rechts/linkszijde)
- Keuzeschakelaar, linksom en rechtsom draaien en blokkerstand (voor transport)
- Geleverd in hard kunststof koffer met 2 lithium ionbatterijen (2 AH) en snellader (50 min)



CE

1972/K12V-10

€ 239,00 1 019720112

316x254x96 mm - 2,3 kg

1982/K12V

Omschakelbare slagschroevendraaier, 12V",
ideaal voor klussen in kleine ruimtes, biedt een hoog koppel (80 Nm), bediening met één hand"

- UltraCompact: niet meer dan 160 mm lang; Ultra licht gewicht: niet meer dan 1 kg inclusief batterij en perfect uitgebalanceerd
- 1/4" aandrijfvierkant met vergrendeling
- riemclip (rechts/linkszijde)
- LED licht voorzijde
- Keuze schakelaar, linksom en rechtsom draaien en blokkerstand (voor transport)
- Ergonomische antislip handgreep
- Tandwielkast geheel vervaardigd uit metaal
- 2Ah -E42 batterijen met laadindicator op behuizing van de slagschroevendraaier
- Geleverd in hard kunststof koffer met 2 lithium -ionbatterijen (2 AH) en snellader (50 min)



CE

1982/K12V

€ 239,00 1 019820112

316x254x96 mm - 2,3 kg

1972/K12V-COMBO

12V Set bestaande uit ultracompacte boormachine en omschakelbare slagmoersleutel

Kofferinhoud:

- 1 ultracompacte boormachine van 12 V, met automatische boorkop van 10 mm
- 1 12V omschakelbare slagmoersleutel, met 1/4" aandrijfvierkant
- 2 lithium-ionbatterijen van 2 Ah
- 1 snellader



CE

1972/K12V-COMBO

€ 406,00 1 019720010

310x295x100 mm - 3 kg

1972/12V-10

Ultracompacte boormachine, 12V (losse body)

- Ultracompact - niet meer dan 170 mm lang; ultralichtgewicht - niet meer dan 1,1 kg (met accu) en perfect uitgebalanceerd
- Metalen automatische boorhouder van 10 mm
- Koppel tot 30 Nm en 1300 tpm (400 tpm in 1e versnelling); boort diameters tot 10 mm in staal en 20 mm in hout
- Dubbele mechanische snelheid met stalen tandwielen (0-400/1300 rpm)
- 20 mogelijke koppelstanden
- Keuzeschakelaar, schroeven-losschroeven-vergrendelen (voor transport)
- Voor-LED
- Ergonomisch antisliphandvat
- Riemclip (rechts/links)

790 g

1972/12V-10

€ 105,00 1 019720113

Beta
3-YEAR
WARRANTY



0-400/min
0-1300/min

30 Nm



CE

1982/12V

Omschakelbare slagschroevendraaier, 12V (losse body)

Ideaal voor het werken in kleine ruimtes, ontwikkelt een hoog koppel (80 Nm); ontworpen voor gebruik met één hand

- ultracompact - niet meer dan 160 mm lang; ultralichtgewicht - niet meer dan 1 kg, met batterij en perfect uitgebalanceerd
- 1/4" zeskantaandrijving, met borgmoer
- riemclip (rechts/links)
- LED vooraan
- keuzeschakelaar, schroef-losschroef-vergrendelmodi (voor transport)
- ergonomische antisliphandgreep
- tandwielkast geheel van metaal

800 g

1982/12V

€ 109,00 1 019820113

Beta
3-YEAR
WARRANTY



80 Nm



CE

1994BL 12V-2AH

2Ah lithium-ion accu voor Power Tools, 12V

Belangrijkste kenmerken

- Batterijspanning: 12V
- Batterijcapaciteit: 2Ah
- Energiecapaciteit: 24Wh
- Batterijtype: Li-ion

170 g

1994BL 12V-2AH

€ 79,00 1 019940015



CE

1994CB 12V

Snellader accu, 12V, 110V-240V

Belangrijkste kenmerken:

- LED-laadniveau-indicator
- Nominale ingangsspanning: 110V-240V ~ 50/60Hz
- Uitgangsspanning: 12,6V
- Laadstroom: 2A
- Nominale ingangsvermogen: 35W
- 2Ah accu-oplaadtijd: 50 min

260 g

1994CB 12V

€ 79,00 1 019940123



CE

1972/K20V-13BMC

Klopboormachine (set) 20V borstelloos

CE

• Digitale borstelloze motor
Aanzienlijk verbeterde prestaties: meer vermogen, lager energieverbruik, langere levensduur van de motor, verbeterde stroomvoorziening via de knop

- 3 bedrijfsmodi: boren, schroeven en klopboren
- Compact: maximaal 210 mm lang
- Ergonomisch antisliphandvat
- Keuzeschakelaar, schroeven-losschroeven-vergrendelen (voor transport)
- Tandwielkast geheel van metaal
- Ingebouwd LED-licht voor werken bij slecht zicht
- Riemclip (rechts/links)
- Extra zijhandgreep voor bediening met hoog koppel
- Geleverd in een harde koffer met 2 lithium-ionbatterijen (4 Ah) en snellader

Belangrijkste kenmerken:

- Max. koppel: 80 Nm
- Draaimomentaanpassing in 20 standen
- Metalen automatische boorkop van 13 mm
- Dubbele mechanische snelheid met stalen tandwielen (0-450/1650 rpm)
- Max. boordiameter in hout: 55 mm
- Max. boordiameter in metaal: 13 mm
- Max. boordiameter in metselwerk: 13 mm

Beta
**3-YEAR
WARRANTY**

BESCHIKBAAR
VANAF MEI



1972/K20V-13BMC

€ 495,00 1 019720020

490x370x125 mm - 5,5 kg

1972/20V-13BMC

klopboormachine, 20V, BORSTELLOOS (losse body)

CE

• Digitale borstelloze motor
Aanzienlijk verbeterde prestaties: meer vermogen, lager energieverbruik, langere levensduur van de motor, verbeterde stroomvoorziening via de knop

- 3 bedrijfsmodi: boren, schroeven en klopboren
- Compact: maximaal 210 mm lang
- Ergonomisch antisliphandvat
- Keuzeschakelaar, schroeven-losschroeven-vergrendelen (voor transport)
- Tandwielkast geheel van metaal
- Ingebouwd LED-licht voor werken bij slecht zicht
- Riemclip (rechts/links)
- Extra zijhandgreep voor bediening met hoog koppel
- Geleverd in een harde koffer, zonder batterijen en oplader

Belangrijkste kenmerken:

- Max. koppel: 80 Nm
- Draaimomentaanpassing in 20 standen
- Metalen automatische boorkop van 13 mm
- Dubbele mechanische snelheid met stalen tandwielen (0-450/1650 rpm)
- Max. boordiameter in hout: 55 mm
- Max. boordiameter in metaal: 13 mm
- Max. boordiameter in metselwerk: 13 mm

Beta
**3-YEAR
WARRANTY**

BESCHIKBAAR
VANAF MEI



1972/20V-13BMC

€ 215,00 1 019720019

490x370x125 mm - 3,6 kg

1984/K600

- Digitale KOOLBORSTELLOZE motor
- Opmerkelijk verbeterde prestaties, waaronder: hoger vermogen, lager energieverbruik, langere levensduur van de motor, verbeterde vermogensafgifte via drukknop
- Tandwielkast geheel van metaal
- Ergonomische antislip handgreep
- 1/2" aansluiting met busborgring
- Keuze schakelaar, linksom en rechtsom draaien en blokkeerstand (voor transport)
- Ingebouwd LED-licht
- LED-indicator voor het laadniveau van de batterij
- Riemclip (rechts/links)

Aanhaalmoment

Er kunnen drie verschillende koppel- en toerentalinstellingen worden geselecteerd

(laag - gemiddeld - hoog):

- 1: 200Nm; 1000 TPM
- 2: 350Nm; 1500 TPM
- 3: 550 Nm; 1800 TPM

Losdraaien

1: 600 Nm: slagmoersleutel past maximaal koppel toe in continue modus (vrij losdraaien)

2: 600 Nm - Zelfstopfunctie: slagmoersleutel past maximaal koppel toe totdat de moer volledig is losgedraaid en stopt dan automatisch (one-shot losdraaien)

Geleverd in handige hardcase compleet met 2 lithium ion accu's (6 Ah) en snellader.



1984/K600

€ 695,00



1



019840060

490x370x125 mm - 6,3 kg

1984 20V/600BMC

omkeerbare slagmoersleutel, 20V, BORSTELLOOS, met 1/2" aandrijving - 600 Nm (losse body)

- 3 verschillende koppelinstellingen en toerentallen in de schroefmodus
- Tot 600 Nm losdraaimoment
- Digitale BORSTELLOZE motor
- Aanzienlijk verbeterde prestaties: meer vermogen, lager energieverbruik, langere levensduur van de motor, verbeterde stroomvoorziening via de knop
- 1/2" buitenvierkantaandrijving met busborgring
- Tandwielkast geheel van metaal
- Ergonomisch antisliphandvat
- Keuzeschakelaar, schroeven-losschroeven-vergrendelen (voor transport)
- Ingebouwd LED-licht voor werken bij slecht zicht
- Riemclip (rechts/links)
- Geleverd in een harde koffer, zonder batterijen en oplader

Aanscherping

3 koppelinstellingen en toerentallen (laag - gemiddeld - hoogte) beschikbaar:

- 1: 200 Nm; 1000 tpm
- 2: 350 Nm; 1500 tpm
- 3: 550 Nm; 1800 tpm

Losmaken

1: 600 Nm: slagmoersleutel past non-stop maximaal koppel toe (vrij losdraaien)

2: 600 Nm - Autostop: slagmoersleutel past maximaal koppel toe totdat de moer volledig is losgedraaid, en stopt dan automatisch (enkele slag losdraaien)



1984 20V/600BMC

€ 375,00



1



019840907

490x370x125 mm - 4,4 kg

1984/K1200

omschakelbare slagmoersleutel, 20 V, koolborstelloos, 1/2" aansluiting - 1000 Nm

CE

- Digitale KOOLBORSTELLOZE motor
- Opmerkelijk verbeterde prestaties, waaronder: hoger vermogen, lager energieverbruik, langere levensduur van de motor, verbeterde vermogensafgifte via drukknop
- Tandwielkast geheel van metaal
- Ergonomische antislip handgreep
- 1/2" aansluiting met busborgring
- Keuze schakelaar, linksom en rechtsom draaien en blokkeerstand (voor transport)
- Ingebouwd LED-licht
- LED-indicator voor het laadniveau van de batterij
- Riemclip (rechts/links)

Aanhaalmoment

Er kunnen drie verschillende koppel- en toerentalinstellingen worden geselecteerd (laag - gemiddeld - hoog):

- 1: 300 Nm; 900 TPM
- 2: 500 Nm; 1600 TPM
- 3: 680 Nm; 1900 TPM

Losdraaien

- 1: 1000 Nm - slagmoersleutel past maximaal koppel toe in continue modus (vrij losdraaien)
- 2: 1000 Nm - Zelfstopfunctie: slagmoersleutel past maximaal koppel toe totdat de moer volledig is losgedraaid en stopt dan automatisch (one-shot losdraaien)

Geleverd in handige hardcase compleet met 2 lithium ion accu's (6 Ah) en snellader.



1984/K1200

€ 795,00 1 019840120

490x370x125 mm - 7 kg

1984 20V/1200BMC

omkeerbare slagmoersleutel, 20V, BORSTELLOOS, met 1/2" aandrijving - 1200 Nm (losse body)

CE

Ideaal voor toepassingen die een hoog koppel vereisen.

- 3 verschillende koppelinstellingen en toerentallen in schroefmodus
- Tot 1200 Nm losdraaimoment
- Tot 1700 Nm piekkoppel
- Digitale BORSTELLOZE motor
- Aanzienlijk verbeterde prestaties: meer vermogen, lager energieverbruik, langere levensduur van de motor, verbeterde stroomvoorziening via de knop
- 1/2" buitenvierkantaandrijving met busborgring
- Tandwielkast geheel van metaal
- Ergonomisch antisliphandvat
- Keuzeschakelaar, schroeven-losschroeven-vergrendelen (voor transport)
- Ingebouwd LED-licht voor werken bij slecht zicht
- Riemclip (rechts/links)
- Geleverd in een harde koffer, zonder batterijen en oplader

Aanscherping

3 koppelinstellingen en toerentallen (laag - gemiddeld - hoogte) beschikbaar:

- 1: 350 Nm; 800 tpm
- 2: 600 Nm; 1400 tpm
- 3: 900 Nm; 1600 tpm

Losmaken

- 1: 1200 Nm: slagmoersleutel past non-stop maximaal koppel toe (vrij losdraaien)
- 2: 1200 Nm - Autostop: slagmoersleutel past maximaal koppel toe totdat de moer volledig is losgedraaid, en stopt dan automatisch (enkele slag losschroeven)



1984 20V/1200BMC

€ 425,00 1 019840911

490x370x125 mm - 4,7 kg

1986/K20V-125

Haakse slijper (set) 20V, Borstelloos

Digitale BORSTELLOZE motor

Aanzienlijk verbeterde prestaties: meer vermogen, lager energieverbruik, langere levensduur van de motor, verbeterde stroomvoorziening via de knop

Belangrijkste kenmerken

- Bescherming tegen onbedoelde herstart* Extra handgreep, aan beide zijden te plaatsen
- Gereedschapsloze schijfafdekking (snelsluiting)
- Asvergrendeling voor snelle schijfwissels
- Aan/uit-schuifschakelaar vergrendelen
- Ventilatieopeningen beschermd tegen binnendringend stof en zorgen voor optimale koeling
- Geleverd in een koffer met 2 Ah lithium-ion batterijen en een snellader

Technische data

- Schijfdiameter : 125/115 mm
- Vrije snelheid: 8.000 tpm
- Gereedschapsspindelschroefdraad: M14
- Kabellengte: 4 m

Beta
**3-YEAR
WARRANTY**

BESCHIKBAAR
VANAF MEI



CE

1986/K20V-125

€ 525,00



1



019860015

490x370x125 mm - 5,6 kg

1986/20V-125BMC

haakse slijper, 20V BORSTELLOOS, (losse body)

Digitale BORSTELLOZE motor

Aanzienlijk verbeterde prestaties: meer vermogen, lager energieverbruik, langere levensduur van de motor, verbeterde stroomvoorziening via de knop

Belangrijkste kenmerken

- Bescherming tegen onbedoelde herstart* Extra handgreep, aan beide zijden te plaatsen
- Gereedschapsloze schijfafdekking (snelsluiting)
- Asvergrendeling voor snelle schijfwissels
- Aan/uit-schuifschakelaar vergrendelen
- Ventilatieopeningen beschermd tegen binnendringend stof en zorgen voor optimale koeling
- Geleverd in een koffer, zonder batterijen en oplader

Technische data

- Schijfdiameter : 125/115 mm
- Vrije snelheid: 8.000 tpm
- Gereedschapsspindelschroefdraad: M14
- Kabellengte: 4 m

Beta
**3-YEAR
WARRANTY**

BESCHIKBAAR
VANAF MEI



CE

1986/20V-125BMC

€ 275,00



1



019860025

490x370x125 mm - 3,8 kg

 **Beta**

1994B 20V-2AH

2Ah lithium-ion accu voor Power Tools, 20V

Premium lithium-iontechnologie
Met knop en 3 gekleurde LED-laadniveau-indicatoren

Belangrijkste kenmerken

- Batterijspanning: 20V
- Batterijcapaciteit: 2Ah
- Energiecapaciteit: 40Wh
- Batterijtype: Li-ion

410 g



BESCHIKBAAR
VANAF MEI

CE

1994B 20V-2AH

€ 89,00 1 019940022

1994B 20V-4AH

4Ah lithium-ion accu voor Power Tools, 20V

Premium lithium-iontechnologie
Met knop en 3 gekleurde LED-laadniveau-indicatoren

Belangrijkste kenmerken

- Batterijspanning: 20V
- Batterijcapaciteit: 4Ah
- Energiecapaciteit: 80Wh
- Batterijtype: Li-ion

660 g



BESCHIKBAAR
VANAF MEI

CE

1994B 20V-4AH

€ 129,00 1 019940044

1994B 20V-6AH

6Ah lithium-ion accu voor Power Tools, 20V

Premium lithium-iontechnologie
Met knop en 3 gekleurde LED-laadniveau-indicatoren

Belangrijkste kenmerken

- Batterijspanning: 20V
- Batterijcapaciteit: 6Ah
- Energiecapaciteit: 120Wh
- Batterijtype: Li-ion

900 g



BESCHIKBAAR
VANAF MEI

CE

1994B 20V-6AH

€ 165,00 1 019940066

1994C 20V

Snellader accu, 20V, 110V-240V

Belangrijkste kenmerken:

- LED-laadniveau-indicator
- Nominale ingangsspanning: 110V-240V ~ 50/60Hz
- Uitgangsspanning: 20V
- Laadstroom: 6A
- Nominale ingangsvermogen: 145W

Oplaadtijd 20V 2Ah batterij: 45 min
Oplaadtijd 20V 4Ah batterij: 90 min
Oplaadtijd 20V 6Ah accu: 120 min

570 g



BESCHIKBAAR
VANAF MEI

CE

1994C 20V

€ 99,00 1 019940140

1989RCB

bouwradio, 20V

CE

Multifunctioneel audio-entertainment: digitale (DAB; Bluetooth) en conventionele FM-radio

Geschikt voor gebruik op bouwplaatsen of voor vrije tijd

Stevige radio met compact, modern design, beschermingsgraad IP54
Krachtig stereogeluid door twee krachtige zijluidsprekers van 16 W

Ingebouwde alarmfunctie

Compleet met draaggreep en schokbestendige hoekbescherming

Met AUX-aansluiting en beveiligde USB-aansluiting voor telefoonaansluiting en opladen

Kan worden gebruikt met Beta's 20V-batterijen (optioneel) of netsnoer (meegeleverd).

Belangrijkste kenmerken:

- FM-radiofrequentiebereik: 87,5 – 108 MHz
- DAB-radiofrequentiebereik: 174 – 240 MHz
- Aantal opgeslagen FM- en DAB-zenders: 30
- Luidsprekervermogen: 16 W
- Nominale spanning van de batterij (optioneel): 20 V
- Afmetingen radio: 180 x 205 x 305 mm
- Gewicht radio (zonder batterij): 3,2 kg

BESCHIKBAAR
VANAF MEI



1989RCB

€ 309,00 1 019890020

C9PT

technische stoffen tas voor accugereedschap

Perfect voor het gemakkelijk meenemen van de Powertools van Beta

Gemaakt van superduurzaam technisch materiaal

Dubbele handgreep aan de bovenkant voor een veilige, evenwichtige grip

BESCHIKBAAR
VANAF MEI



C9PT

€ 35,00 1 021090001

400x210x290 mm - 2,4 kg

Beta



- Ventilatieopeningen zorgen voor optimale koeling, beschermd tegen binnendringend stof

• **Ongeëvenaarde veiligheid voor operators**

- Spindelvergrendeling voor snelle schijfwissels
- Bescherming tegen onbedoelde activering
- Soepele start, voor het beperken van een grote initiële schok bij het opstarten

• **Uniek comfort en gebruiksgemak**

- Antislip ergonomisch handvat voor verbeterde grip
- Verlaagd hoofd waardoor werken in krappe ruimtes mogelijk is

Anti-knoop kabel van maar liefst 4 meter lang voor meer bewegingsgemak

Extra handgreep die aan beide zijden gemonteerd kan worden.

1956 115-750W

haakse slijper voor schijven Ø 115 mm

Ideaal voor doorslijp-, slijp- en voorbewerkingen

Krachtige motor (750 W)

Ergonomische antisliphandgreep voor meer comfort en veiligheid

Verlaagde kop waardoor werken in krappe ruimtes mogelijk is

Extreem lichtgewicht (weegt niet meer dan 1,8 kg)

Belangrijkste kenmerken:

- Herstartbeveiliging, start niet automatisch na stroomuitval
- Extra handgreep die aan beide zijden kan worden gemonteerd
- Schijfafdekking gereedschapsloos te de-monteren (snelontgrendeling)
- Spindelvergrendeling voor snelle schijfwissels
- Vergrendel-aan/uit-schuifschakelaar
- Ventilatieopeningen beschermd tegen stofinfiltratie en optimale koelprestaties
- Inclusief servicesleutel

1,8 kg



1956 115-750W

€ 85,00 1 019560011

1956 125-1400W

haakse slijper voor schijven Ø 125 mm

Ideaal voor doorslijp-, slijp- en voorbereidingen

Krachtige motor (1400 W) - Variabele snelheid
Ergonomische antisliphandgreep voor meer comfort en veiligheid
Verlaagde kop waardoor werken in krappe ruimtes mogelijk is

Belangrijkste kenmerken:

- Herstartbeveiliging, start niet automatisch na stroomuitval
- Extra anti-vibratie handgreep die aan beide zijden kan worden gemonteerd
- Schijfafdekking gereedschapsloos te de-monteren (snelontgrendeling)
- Spindelvergrendeling voor snelle schijfwissels
- Vergrendel-aan/uit-schuifschakelaar
- Ventilatieopeningen beschermd tegen stofinfiltratie en optimale koelprestaties
- Inclusief servicesleutel

2,5 kg

CE

L = 4 m



1956 125-1400W

€ 164,00 1 019560125

1956 230-2400W

haakse slijper voor schijven Ø 230 mm

Ideaal voor complexe knip-, slijp- en vijlklassen

Krachtige motor (2400 W)
Ergonomische antisliphandgreep voor meer comfort en veiligheid

Belangrijkste kenmerken:

- Herstartbeveiliging, start niet automatisch na stroomuitval
- Extra handgreep die aan beide zijden kan worden gemonteerd
- Schijfafdekking gereedschapsloos te de-monteren (snelontgrendeling)
- Schroevendeksel
- Spindelvergrendeling voor snelle schijfwissels
- Vergrendel-aan/uit-schuifschakelaar
- Ventilatieopeningen beschermd tegen stofinfiltratie en optimale koelprestaties
- Inclusief servicesleutel

5,8 kg

CE

L = 4 m



1956 230-2400W

€ 221,00 1 019560230

1966/910W

klopboormachine, 910W

Ideaal voor het boren in verschillende materialen, waaronder hout, metaal, kunststof, metselwerk en beton

Krachtige motor van 910 W

Lineair, compact ontwerp met ergonomische, antisliphandgreep

Metalen automatische spantang, 13 mm

Omkeerbare variabele snelheid

Tandwielkast geheel van metaal

Schakelaarvergrendeling voor verbeterd gebruikscomfort

Belangrijkste kenmerken:

- Max. boordiameter in hout: 32 mm
- Max. boordiameter in metaal: 13 mm
- Max. boordiameter in metselwerk: 13 mm
- Onbelast toerental: 0-2800 tpm
- Kabellengte zonder knopen: 4 m

Meegeleverde accessoires:

- Metalen automatische spantang, 13 mm
- Extra zijhandgreep die 360° draaibaar is
- Dieptestang

BESCHIKBAAR
VANAF MEI



CE

1966/910W

€ 150,00



1



019660091

420x320x120 mm - 4,3 kg

1967/800W

SDS-PLUS boormachine, 800W

Ideaal voor boren, hameren en beitelen in metselwerk, beton, tegels, hout en metaal

Krachtige motor van 800 W voor zware toepassingen

Professioneel, lichtgewicht en krachtig

Ergonomisch, compact ontwerp, voor werken in kleine/beperkte ruimtes

Belangrijkste kenmerken

3 bedrijfsmodi + Vario-Lock-functie:

- boorfunctie
- hamerfunctie
- beitelfunctie
- Vario-lock-functie: kan in 36 beitelpoziities worden vergrendeld, voor het verkrijgen van een optimale werkhoek

• Max. boordiameter in hout: 30 mm

• Max. boordiameter in metaal: 13 mm

• Max. boordiameter in beton: 26 mm

Omkeerbaar

Veiligheidskoppeling

Slagkracht: 3,2 J

Onbelast toerental: 0-1350 tpm

Aantal slagen: 0-5700 slagen/min

Kabellengte: 4 m

Meegeleverde accessoires:

- 13 mm boorkop met SDS-PLUS-adapter
- Extra zijhandgreep die 360° draaibaar is
- Dieptestang
- 3 steenboren, Ø 8-10-12 mm, lengte 150 mm
- 1 platte beitel, 14x250 mm
- 1-puntsbeitel, 14x250 mm

BESCHIKBAAR
VANAF MEI



CE

1967/800W

€ 180,00



1



019670080

420x300x115 mm - 5,2 kg



1850D

Heteluchtpistool, 3 snelheden

- Pos. I 250 l/min 50 °C
- Pos. II 250 l/min 400 °C
- Pos. III 500 l/min 550 °C



1850D	L mm 255	H mm 210	€ 146,50	1	018500018
-------	----------------	----------------	-------------	---	-----------

1850E

Instelbare elektronische hetelucht pistool

- Pos. I 250-500 l/min 50 °C
- Pos. II 250-500 l/min 50-650 °C

- Digitaal display
- drukknoppen voor instelling van temperatuur en luchtafgifte
- 4 voor ingestelde posities en mogelijkheid tot andere aanpasbare programmas

- Prog 1 150 °C ca. 400 l/min
- Prog 2 200 °C ca. 400 l/min
- Prog 3 300 °C ca. 450 l/min
- Prog 4 400 °C ca. 500 l/min



1850E	L mm 255	H mm 210	€ 306,00	1	018500020
-------	----------------	----------------	-------------	---	-----------

1851VK

elektrisch lijmpistool met 12 lijmstaven in koffer

- vermogen: 80 W
- geschikt voor lijmstaven van ø 11 mm en 12 mm

CE



1851VK	€ 61,50	1	018510058
320x250x50 mm			

1851VK-12C

12 verwarmbare lijmstaven
Ø 11 mm



1851VK-12C	€ 15,20	1	018510062
------------	------------	---	-----------

1851VK-12V

12 verwarmbare lijmstaven
voor gelakte delen
Ø 11 mm



1851VK-12V	€ 15,40	1	018510072
------------	------------	---	-----------



1870

Water en stofzuiger, 20 l

- Eentrapsmotor
- Volt: 220/240 V
- Frequentie: 50/60 Hz
- Max. vermogen: 1200 W
- Luchtverplaatsing: 58 l/sec.
- Max. zuigkracht: 190 mbar
- Max. tank capaciteit: 20 l, vervaardigd uit antistatisch PP
- Acoustische emissie: <70 dB(A)
- Kabel lengte: 5 m
- Houder voor teobehoren
- AANSLUITING TOEBEHOREN, Ø 36 mm
- 1 Geonduleerde slang met ergonomische handgreep
- 2 Harde verlengpijpen
- 1 Universele borstel voor stof en vloeistoffen
- 1 Plat neusstuk
- FILTER SYSTEEM
- 1 Stoffilter in hoder 1900 cm² - 12 µm nom.
- 1 Anti-schuim filter PPI 45/PPI 30

CE



IPX4

1870	€ 255,00	1	018700020
------	-------------	---	-----------

1870I

droog en nat stofzuiger, 20 l,
roestvrijstalen trommel

- eentraps bypass-motor
- spanning: 220/240 V
- frequentie: 50/60 Hz
- max. vermogen: 1200 W
- luchtstroomsnelheid: 58 l/sec.
- max. zuigdruk: 190 mbar
- max. inhoud vat: 20 l, van roestvrij staal
- akoestische emissie: <70 dB(A)
- kabellengte: 5 m
- STANDAARD ACCESSOIRES Ø 36 mm
- 1 gefolde slang met ergonomische handgreep en ontluchting
- 2 harde verlengbuizen
- 1 multifunctionele borstel voor vloeren en vloeistoffen
- 1 plat mondstuk
- 1 papieren zak
- FILTERSYSTEMEN
- 1 luchtfilterpatroon 1900 cm² - 12 µm nom.
- 1 antischuimfilter PPI 45/PPI 30

CE



IPX4

1870I	€ 299,00	1	018700220
-------	-------------	---	-----------

1872L

Water en stofzuiger, 35 liter
"L" klasse gecertificeerd

- Twee-traps by-pass motor
- Volt: 220/240 V
- Frequentie: 50/60 Hz
- Max. vermogen: 1100 W
- Luchtverplaatsing: 55 l/sec.
- Max. zuigkracht: 220 mbar
- Max. tank capaciteit: 35 l, vervaardigd uit anti-statisch PE-HD
- Akoestische emissie: <70 dB(A)
- Kabel lengte: 6 m
- STANDAARD TOEBEHOREN, Ø 36 mm
- 1 Geonduleerde slang met ergonomische handgreep
- 2 Kunststof verlengpijpen
- 1 Gecombineerde borstelhouder
- 1 Gedeelte voor vloeistof zuigmond
- 1 Platte zuigmond
- FILTER SYSTEEM
- 1 Wegwerp filterzak; filtratie klasse: "L"
- 1 Filter houder; IFA klasse: "L"
- 1 Anti-schuim filter PPI 45/PPI 30
- 2 Uitgaande filters, vervaardigd uit PP-gelamineerd PET

CE



IPX4

1872L 35 € 567,00 1 018720135

1873

Water en stofzuiger, 30 l, roestvast stalen tank

- Twee-traps motor • Volt: 220/240 V
- Frequentie: 50/60 Hz • Max. vermogen: 1100 W
- Luchtverplaatsing: 55 l/sec.
- Max. zuigkracht: 220 mbar
- Max. tank capaciteit: 30 l, vervaardigd uit roestvast staal
- Acoustische emissie: <61 dB(A)
- Kabel lengte: 6 m • Houder voor toebehoren:
- AANSLUITING TOEBEHOREN, 45 MM
- 1 Geonduleerde slang met ergonomische handgreep
- 2 Roestvast stalen verlengpijpen
- 1 Industriële borstelhouder
- 1 Industriële mondstuk voor tapijten
- 1 Industriële mondstuk voor het opzuigen van vloeistoffen
- 1 Platte zuigmond
- FILTER SYSTEEM
- 1 Papieren stofzak
- 1 Oppervlakte filterhouder 1900 cm², 12 µm nom.
- 1 Anti-schuim filter PPI 45/PPI 30

CE



1873 30 € 739,00 1 018730030

1874

Water en stofzuiger, 50 l, Roestvast stalen tank

- Twee-traps motor • Volt: 220/240 V
- Frequentie: 50/60 Hz • Max. vermogen: 1350 W
- Luchtverplaatsing: 55 l/sec.
- Max. zuigkracht: 240 mbar
- Max. tank capaciteit: 50 l, vervaardigd uit roestvast staal
- Acoustische emissie: <63 dB(A)
- Kabel lengte: 6 m • Houder voor toebehoren
- AANSLUITING TOEBEHOREN, Ø 45 mm
- 1 Geonduleerde slang met ergonomische handgreep
- 2 Roestvast stalen verlengpijpen
- 1 Industriële borstelhouder
- 1 Industriële zuigmond voor tapijten
- 1 Industriële inzetstuk voor het opzuigen van vloeistoffen
- 1 Platte zuigmond
- FILTER SYSTEEM
- 1 Papieren stofzak
- 1 Oppervlakte filterhouder 5200 cm², 12 µm nom.
- 1 Anti-schuim filter PPI 45/PPI 30

CE



1874 50 € 918,00 1 018740050

1870-20/5S

5 horizontale papieren stofzakken voor artikel 1870-1870I-1875LT



1870 20/5S € 59,00 1 018700021

1870-72 /FC

Houder met filter 1900 cm² 12 - µm nom.
Voor artikelen 1870 - 1870I - 1873 - 1875LT



1870/FC € 52,50 1 018700026

1870-72/FL

Waterfilter voor artikelen 1870 - 1870I - 1872L - 1873 - 1874 - 1875LT



1870 72/FL € 19,70 1 018700027

1872L 35/FC

Filterhouder, "L" klasse, voor artikel 1872L



1872L 35/FC € 63,00 1 018720144

1872L 35/5S

5 wegwerp stofzakken, "L" klasse voor artikel 1872L - 1873



1872L 35/5S € 95,00 1 018720136

1873-30/5S

5 verticale papieren stofzakken voor artikel 1873



1873 30/5S € 62,00 1 018730031

1874-50/5S

5 verticale stofzakken voor artikel 1874



1874 50/5S € 76,50 1 018740051

1874-50/FC

Houder met filter filter 5200 cm² - 12 µm nom. voor artikel 1874



1874 50/FC € 64,00 1 018740056



PNEUMATISCH GEREEDSCHAP EN TOEBEHOREN

In meer dan 20 jaar heeft Beta Utensili het product programma vergroot met een veelomvattende lijn van perslucht gereedschappen en toebehoren. Deze lijn is ontwikkeld voor zowel de automotive als de industriële markt en bevat; slagmoersleutels, ratels, boormachines, slijpmachines en vele andere soortgelijke producten.

Gedurende deze periode is er een hechte samenwerking geweest met professionele gebruikers, met als resultaat, dat er een constante groei is ontstaan. De kern van deze groei is gebaseerd op het feit dat de Beta's persluchtgereedschappen een excellente ratio hebben tussen betrouwbaarheid en prestatie.



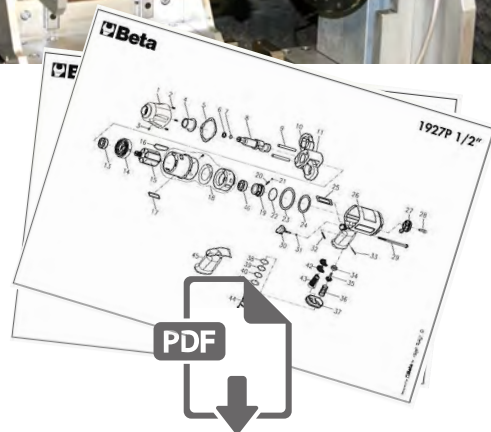
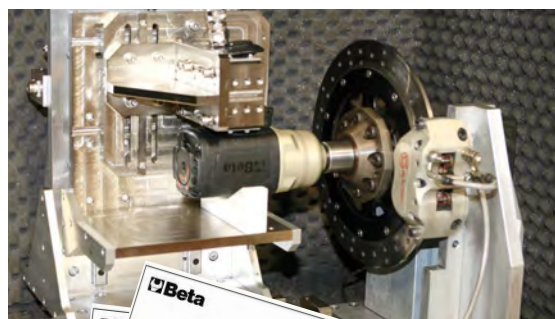























Om zo goed mogelijk aan de markt vraag te kunnen voldoen, repareert Beta Utensili de persluchtgereedschappen zelf op de afdeling "Kwaliteitszorg". Mede door deze procedure maakt het mogelijk om onze kennis in belangrijke mate te vergroten om steeds meer responsief te kunnen zijn naar onze klanten.





www.beta-tools.com

HULP BIJ HET KIEZEN VAN PNEUMATISCH GEREEDSCHAP













SLAGMOERSLEUTELS

■	BETA ITEM	N °	MATERIAAL	 max. Nm	 db (A) LpA	 db (A) LpW	 l/min.	 kg	MECHANISME	 m/s ²
3/8"		1924F	Aluminium	108	93,6	104,6	59	0,5	Dubbele hamer	6,85
3/8"		1924B	Aluminium	353	91	95	80	1,5	Pin clutch	7,9
3/8"		1924CD	Composiet materiaal	410	91,7	102,7	79	1,3	Dubbele hamer	6,2
3/8"		1924XM	Composite materiaal	515	91,7	102,7	122	1,3	Enkele hamer	6,2
1/2"		1927AN	Aluminium	244	89,4	100,4	190	2,1	Enkele hamer	8,63
1/2"		1927G	Aluminium	325	92,2	103,2	113	1,2	Enkele hamer	9,96
1/2"		1927B	Aluminium	705	98,0	109,0	133	2,1	Pin clutch	14,08
1/2"		1927XM	Aluminium	770	102	113	122	1,3	Enkele hamer	7,5
1/2"		1927CD	Composiet materiaal	1.020	95,5	106,5	130	2,3	Dubbele hamer	7,2
1/2"		1927P	Composiet materiaal	1.750	95,1	106,1	290	2,0	Dubbele hamer	6,7
3/4"		1928XM	Aluminium	1.600	91,8	102,8	175	2,9	Dubbele hamer	12,96
3/4"		1928DA	Aluminium	1.695	96	99,5	300	4,3	Dubbele hamer	3,6
3/4"		1928DAL	Aluminium	1.695	96	99,5	300	4,8	Dubbele hamer	3,6
3/4"		1928CD	Composiet materiaal	1.800	97,5	108,5	215	3,5	Dubbele hamer	11,4
3/4"		1928P	Composiet materiaal	2.100	96,2	107,2	221	3,7	Dubbele hamer	7,6
1"		1930CD	Composiet materiaal	2.445	95,6	97,1	410	7,1	Dubbele hamer	3,6
1"		1930PA	Aluminium	2.445	96,0	97,1	410	9,6	Dubbele hamer	7,2
1"		1930A	Aluminium	2.445	103,3	114,3	460	9,5	Dubbele hamer	67
1"		1930LH	Aluminium	2.441	97,1	108,1	282	7,1	Dubbele hamer	17,4
1"		1930LA	Aluminium	2.445	95,6	97,1	460	10,6	Dubbele hamer	3,6

HULP BIJ HET KIEZEN VAN PNEUMATISCH GEREEDSCHAP

■	BETA ITEM	N°	MATERIAAL	max. Nm	db (A) LpA	db (A) LpW	l/min.	kg	MECHANISME	m/s ²
1"		1930HLA	Aluminium	3.661	99	101	460	16,4	Dubbele hamer	16,4
1 1/2"		1930ZL	Aluminium	4.068	102,4	113,4	480	15	Dubbele hamer	69.6

LUCHTRATELS

■	BETA ITEM	N°	 max. Nm	 db (A) LpA	 db (A) LpW	 l/min.	 kg	 m/s ²
14"		1921B1	24	96	85	90	0,4	2.6
14"		1921M1	27	84	88	96	0,6	1.8
14"		1922P1	68	90,6	101,6	88	0,6	8.61
38"		1921M2	27	84	88	96	0,6	1.8
38"		1922P2	68	90,6	101,6	88	0,6	8.61
12"		1921N3	68	80	87	140	1,2	2.6
12"		1922P3	136	94,9	105,9	113	1,5	18.28

SLIJPMACHINES

	BETA ITEM	N°	VERMOGEN	 db (A) LpA	 db (A) LpW	 l/min.	 kg	 m/s ²
		1933	0,20 kW	80,0	87,0	230	0,38	4,53
		1933L	0,20 kW	80,0	87,0	270	0,67	1,15
		1933AN90	0,20 kW	80,0	87,0	230	0,51	1,24
		1933I	0,38 kW	80,0	87,0	260	0,67	4,53
		1933IL	0,38 kW	79,0	97,0	113	1,4	1,6
		1933IH	0,75 kW	88,1	99,1	370	0,8	2,6
		1933ILH	0,75 kW	85,7	96,7	370	1,2	1,4
		1933AN90-H	0,75 kW	85,6	96,6	370	1,1	6,7
		1934MAV	0,04 kW	71	76	115	0,2	2,5
		1934MAV70	0,08 kW	80	87	115	0,2	4

1921B1

Omschakelbare mini luchtratel

1/4"

CE



Onbelast toerental	350 rpm
Max. aanhaalkoppel	24 Nm
Boutcapaciteit	CI 8.8 M7●11 mm
Boutcapaciteit	CI 12.9 M6●10 mm
Luchtaansluiting	1/4" GAS
Werkdruk	6,2 bar
Luchtslang binnen (Ø)	8 mm
Gemiddeld luchtverbruik	68 l/min
Gewicht	0,4 kg

1/4	€ 286,00	1	019210001
-----	----------	---	-----------

1921M1

Compacte omschakelbare luchtratel

• Snelheid instelbaar door regelknop.

1/4"

CE



Onbelast toerental	200 rpm
Max. aanhaalkoppel	27 Nm
Bout capaciteit	CI 8.8 M7●11 mm
Bout capaciteit	CI 12.9 M6●10 mm
Luchtinlaat	1/4" GAS
Werkdruk	6.2 bar
Luchtslang binnen (Ø)	8 mm
Gemiddeld luchtverbruik	96 l/min
Gewicht	0.6 kg

1/4	kg 0,6	€ 245,50	1	019210005
-----	--------	----------	---	-----------

1921M2

Compacte omschakelbare luchtratel

• Snelheid instelbaar door regelknop.

3/8"

CE



Onbelast toerental	200 rpm
Max. aanhaalkoppel	27 Nm
Bout capaciteit	CI 8.8 M7●11 mm
Bout capaciteit	CI 12.9 M6●10 mm
Luchtinlaat	1/4" GAS
Werkdruk	6.2 bar
Luchtslang binnen (Ø)	8 mm
Gemiddeld luchtverbruik	96 l/min
Gewicht	0.6 kg

3/8	kg 0,6	€ 245,50	1	019210015
-----	--------	----------	---	-----------

1921N3

Omschakelbare luchtratel

• Snelheid instelbaar door regelknop.

1/2"

CE



Onbelast toerental	150 rpm
Max. aanhaalkoppel	68 Nm
Bout capaciteit	CI 8.8 M10●16 mm
Bout capaciteit	CI 12.9 M8●13 mm
Luchtinlaat	1/4" GAS
Werkdruk	6.2 bar
Luchtslang binnen (Ø)	10 mm
Gemiddeld luchtverbruik	140 l/min
Gewicht	1.2 kg

1/2	kg 1,2	€ 245,50	1	019210025
-----	--------	----------	---	-----------

1922P1

Omschakelbare luchtratel met slagmechanisme

• "Double rocking dog" slagmechanisme

1/4"

CE



Onbelast toerental	700 rpm
Maximaal aanhaalkoppel	68 Nm
Bout capaciteit	CI 8.8 M10●16 mm
Bout capaciteit	CI 12.9 M8●13 mm
Luchtinlaat	1/4" GAS
Werkdruk	6.2 bar
Luchtslang binnen (Ø)	10 mm
Gemiddeld luchtverbruik	88 l/min
Gewicht	0.6 kg

1/4	kg 0,6	€ 295,00	1	019220006
-----	--------	----------	---	-----------

1922P2

Omschakelbare luchtratel met slagmechanisme

• "Double rocking dog" slagmechanisme

3/8"

CE



Onbelast toerental	700 rpm
Maximaal aanhaalkoppel	68 Nm
Bout capaciteit	CI 8.8 M10●16 mm
Bout capaciteit	CI 12.9 M8●13 mm
Luchtinlaat	1/4" GAS
Werkdruk	6.2 bar
Luchtslang binnen (Ø)	10 mm
Gemiddeld luchtverbruik	88 l/min
Gewicht	0.6 kg

3/8	kg 0,6	€ 295,00	1	019220010
-----	--------	----------	---	-----------

1922P3

Omschakelbare luchtratel met slagmechanisme

• "Double rocking dog" slagmechanisme

1/2"

CE



Onbelast toerental	600 rpm
Maximaal aanhaalkoppel	136 Nm
Bout capaciteit	CI 8.8 M12●18 mm
Bout capaciteit	CI 12.9 M10●16 mm
Luchtinlaat	1/4" GAS
Werkdruk	6.2 bar
Luchtslang binnen (Ø)	10 mm
Gemiddeld luchtverbruik	113 l/min
Gewicht	1.5 kg

1/2	kg 1,5	€ 469,00	1	019220013
-----	--------	----------	---	-----------

1924F

Compacte omschakelbare moeraanzetter "vlinder" model

• "Double rocking dog" slagmechanisme

3/8"

CE



Onbelast toerental	12,000 rpm
Maximaal aanhaalkoppel	108 Nm
Bout capaciteit	CI 8.8 M12●18 mm
Bout capaciteit	CI 12.9 M10●16 mm
Luchtinlaat	1/4" GAS
Werkdruk	6.2 bar
Luchtslang binnen (Ø)	10 mm
Gemiddeld luchtverbruik	59 l/min
Gewicht	0.5 kg

3/8	kg 0,5	€ 274,00	1	019240025
-----	--------	----------	---	-----------



1924B

Compacte omschakelbare moeraanzetter

- "Pin Clutch" slagmechanisme



Onbelast toerental	10,000 rpm
Max. aanhaalkoppel	353 Nm
Bout capaciteit	Cl 8.8 M16 ● 24 mm
Boutcapaciteit	Cl 12.9 M14 ● 21 mm
Luchtaansluiting	1/4" GAS
Werkdruk	6,2 bar
Luchtslang binnen (Ø)	8 mm
Gemiddeld luchtverbruik	80 l/min
Gewicht	1,5 kg

3/8"	kg	€	1	019240021
1,5		310,00		

1924XM

Compacte omschakelbare slagmoersleutel

- Enkel hamer slagmechanisme



Onbelast toerental	9.000 tpm / min
Max. koppel	515 Nm
Boutcapaciteit	CL 8.8 M16 ● 24 MM
Boutcapaciteit	CL 12.9 M14 ● 21 MM
Luchtinlaat	1/4" gas
Werkdruk	6.2 Bar
Luchtslang binnen (Ø)	10 mm
Gemiddelde luchtverbruik	122 l / min
Gewicht	1,3 kg

3/8"	kg	€	1	019240030
1,3		285,00		

1927B

Omschakelbare slagmoersleutel

- "Pin Clutch" slagmechanisme



Onbelast toerental	7,000 rpm
Max. aanhaalkoppel	705 Nm
Bout capaciteit	Cl 8.8 M22 ● 34 mm
Boutcapaciteit	Cl 12.9 M18 ● 27 mm
Luchtinlaat	1/4" GAS
Werkdruk	6.2 bar
Binnendiameter slang (Ø)	10 mm
Gemiddeld luchtverbruik	133 l/min
Gewicht	2.1 kg

1/2"	kg	€	1	019270022
2,1		210,00		

1924CD

Omschakelbare slagmoersleutel, vervaardigd uit composiet materiaal

- Dubbelhamer slagwerk



Onbelast toerental	10,000 rpm
Max. aanhaalkoppel	410 Nm
Bout capaciteit	Cl 8.8 M16 ● 24 mm
Boutcapaciteit	Cl 12.9 M14 ● 21 mm
Luchtaansluiting	1/4" GAS
Werkdruk	6,2 bar
Luchtslang binnen (Ø)	8 mm
Gemiddeld luchtverbruik	79 l/min
Gewicht	1,3 kg

3/8"	kg	€	1	019240007
1,3		384,00		



1927B/K5

omschakelbare slagmoersleutel, gemaakt van aluminium, geleverd met 5 slagdoppen, in koffer



Onbelast toerental	7000rpm
Max. aanhaalkoppel	705Nm
boutcapaciteit	Cl 8.8 M22 ● 34 mm
boutcapaciteit	Cl 12.9 M18 ● 27 mm
Luchtinlaat	1/4" GAS
Werkdruk	6.2 bar
luchtslang binnen (Ø)	10 mm
Gemiddeld luchtverbruik	133 l/min
Gewicht	2.1 kg

1/2"	kg	€	1	019270122
3,5		279,00		
350x305x86 mm				

1927CD

Omschakelbare slagmoersleutel, vervaardigd uit composiet materiaal
• Dubbelhamer slagwerk



Onbelast toerental	7,000 rpm
Max. aanhaalkoppel	1.020 Nm
Bout capaciteit	CI 8.8 M22●34 mm
Boutcapaciteit	CI 12.9 M18●27 mm
Luchtaansluiting	1/4" GAS
Werkdruk	6,2 bar
Luchtslang binnen (Ø)	10 mm
Gemiddeld luchtverbruik	130 l/min
Gewicht	2,3 kg

1/2 2,3 € 443,00 1 019270007

1927P

Omschakelbare slagmoersleutel, vervaardigd uit composiet materiaal
• Dubbel hamer slagmechanisme



Onbelast toerental	7,500 rpm
Max. aanhaalkoppel	1.750 Nm
boutcapaciteit	CI 8.8 M24●36 mm
boutcapaciteit	CI 12.9 M20●30 mm
Luchtinlaat	1/4" GAS
Werkdruk	6,2 bar
Luchtslang binnen (Ø)	10 mm
Gemiddeld luchtverbruik	290 l/min
Gewicht	2 kg

1/2 kg 2,0 € 464,00 1 019270008

1927XM

Compacte omschakelbare slagmoersleutel
• Enkele hamer slagmechanisme



Onbelast toerental	10,000 rpm
Max. aanhaalkoppel	770 Nm
Bout capaciteit	CI 8.8 M22●34 mm
Bout capaciteit	CI 12.9 M18●27 mm
Luchtinlaat	1/4" GAS
Werkdruk	6,2 bar
Luchtslang binnen (Ø)	10 mm
Gemiddeld luchtverbruik	122 l/min
Gewicht	1,3 kg

1/2 kg 1,3 € 328,00 1 019270030

1927CD/K3

Assortiment van 1 omschakelbare slagmoersleutel en 3 slagdopsleutels
• Dubbel hamer slagmechanisme



Onbelast toerental	7,000 rpm
Max. aanhaalkoppel	1.020 Nm
Bout capaciteit	CI 8.8 M22●34 mm
Bout capaciteit	CI 12.9 M18●27 mm
Luchtaansluiting	1/4" GAS
Werkdruk	6,2 bars
Binnendiameter slang (Ø)	10 mm
Gemiddeld luchtverbruik	130 l/min
Gewicht	1,9 kg

1/2 kg 4 € 478,00 1 019270107
350x305x86 mm

1927P/K3

Omschakelbare slagmoersleutel, vervaardigd uit composiet materiaal, geleverd met 3 slagdoppen



Onbelast toerental	7,500 rpm
Max. aanhaalkoppel	1.750 Nm
Bout capaciteit	CI 8.8 M24●36 mm
Bout capaciteit	CI 12.9 M20●30 mm
Luchtinlaat	1/4" GAS
Werkdruk	6,2 bar
Binnendiameter slang (Ø)	10 mm
Gemiddeld luchtverbruik	290 l/min
Gewicht	2,9 kg

1/2 kg 4 € 538,00 1 019270118
350x305x86 mm

1927XM/K5

Assortiment van een compacte slagmoersleutel en vijf slagdopsleutels
• Enkele hamer slagmechanisme



Onbelast toerental	10,000 rpm
Max. aanhaalkoppel	770 Nm
Bout capaciteit	CI 8.8 M22●34 mm
Bout capaciteit	CI 12.9 M18●27 mm
Luchtinlaat	1/4" GAS
Werkdruk	6,2 bar
Binnendiameter luchtslang (Ø)	10 mm
Gemiddeld luchtverbruik	122 l/min
Gewicht	1,3 kg

1/2 kg 2,8 € 400,00 1 019270129
307x206x86 mm

1927AN

Haakse omschakelbare slagmoersleutel

- Enkele hamer slagmechanisme

1/2"

CE



Onbelast toerental	4,700 rpm
Max. koppel	244 Nm
Bout capaciteit	CI 8.8 M14●21 mm
Bout capaciteit	CI 12.9 M12●19 mm
Luchtinlaat	1/4" GAS
Werkdruk	6,2 bar
Binnen diameter slang (Ø)	10 mm
Gemiddeld luchtverbruik	190 l/min
Gewicht	2,1 kg

1/2"	kg	€	1	019270012
2,1		550,00		

1927G

Compacte omschakelbare slagmoersleutel

- Enkelhamer slagmechanisme

1/2"

CE



Onbelast toerental	8500 rpm
Max. aanhaalkoppel	325 Nm
Bout capaciteit	CI 8.8 M16●24 mm
Bout capaciteit	CI 12.9 M14●21 mm
Luchtinlaat	1/4" GAS
Werkdruk	6,2 bar
Binnendiameter slang (Ø)	10 mm
Gemiddeld luchtverbruik	113 l/min
Gewicht	1,2 kg

1/2"	kg	€	1	019270050
1,2		457,00		

1927SP-AM

Magnetische gereedschapshouder

- Voorzien van twee sterke magneten met een beschermende rubber laag
- Geschikt voor 1 1/2" moeraanzetter, 4 slagdoppen en 1 momentsleutel
- Capaciteit: 10 kg



g	€	1	019270000
400	72,00		

1928DA

Omschakelbare slagmoersleutel

- Dubbel hamer slagmechanisme

3/4"

CE



Onbelast toerental	5,000 rpm
Max. aanhaalkoppel	1.695 Nm
Bout capaciteit	CI 8.8 M30●46 mm
Boutcapaciteit	CI 12.9 M27●41 mm
Luchtaansluiting	3/8" GAS
Werkdruk	6,2 bar
Luchtslang binnen (Ø)	10 mm
Gemiddeld luchtverbruik	240 l/min
Gewicht	4,3 kg

3/4"	kg	€	1	019280022
4,3		898,00		

1928DAL

Omschakelbare slagmoersleutel

- Dubbel hamer slagmechanisme

3/4"

CE



Onbelast toerental	5,000 rpm
Max. aanhaalkoppel	1.695 Nm
Bout capaciteit	CI 8.8 M27●41 mm
Boutcapaciteit	CI 12.9 M24●36 mm
Luchtaansluiting	3/8" GAS
Werkdruk	6,2 bar
Luchtslang binnen (Ø)	10 mm
Gemiddeld luchtverbruik	240 l/min
Gewicht	4,8 kg

3/4"	kg	€	1	019280023
4,8		967,00		

1928KA

Omschakelbare slagmoersleutel met vier slagdoppen in lage uitvoering

- "Pin Clutch" slagmechanisme

3/4"

CE



Onbelast toerental	4,000 rpm
Max. aanhaalkoppel	1.493 Nm
Bout capaciteit	CI 8.8 M27●41 mm
Boutcapaciteit	CI 12.9 M24●36 mm
Luchtaansluiting	3/8" GAS BSP
Werkdruk	6,2 bar
Luchtslang binnen (Ø)	10 mm
Gemiddeld luchtverbruik	260 l/min
Gewicht slagmoersleute	5,2 kg

3/4"	kg	€	1	019280104
9,3		938,00		
410x330x106 mm				

1928XM

Compacte omschakelbare slagmoersleutel

- Dubbel hamer slagmechanisme
- Opmerkelijk compact en krachtig
- Een-hands omschakelknop
- Drie slagkracht instellingen
- Luchtuitlaat door de handgreep

3/4"

CE



Onbelast toerental	4,800 rpm
Max. aanhaalkoppel	1.600 Nm
Bout capaciteit	CI 8.8 M27●41 mm
Bout capaciteit	CI 12.9 M24●36 mm
Luchtaansluiting	3/8" GAS
Werkdruk	6,2 bar
Luchtslang binnen (Ø)	10 mm
Gemiddeld luchtverbruik	175 l/min
Gewicht	2,9 kg

3/4"	kg	€	1	019280030
2,9		639,00		

1928CD

Omschakelbare slagmoersleutel, vervaardigd uit composiet materiaal
 • Dubbelhamer slagwerk



Onbelast toerental 4,500 rpm
 Max. aanhaalkoppel 1.800 Nm
 Bout capaciteit CI 8.8 M27 ● 41 mm
 Boutcapaciteit CI 12.9 M24 ● 36 mm
 Luchtaansluiting 3/8" GAS
 Werkdruk 6,2 bar
 Lucht slang binnen (Ø) 10 mm
 Gemiddeld luchtverbruik 215 l/min
 Gewicht 3,5 kg

3/4 3,5 € 1.026,00 1 019280007

1928P

Omschakelbare slagmoersleutel, vervaardigd uit composiet materiaal
 Dubbele hamer slagmechanisme



Onbelast toerental 5,000 rpm
 Max. aanhaalkoppel 2.100 Nm
 Bout capaciteit CI 8.8 M30 ● 46 mm
 Bout capaciteit CI 12.9 M27 ● 41 mm
 Luchtaansluiting 3/8" GAS
 Werkdruk 6,2 bar
 Lucht slang binnen (Ø) 10 mm
 Gemiddeld luchtverbruik 221 l/min
 Gewicht 3,7 kg

3/4 3,7 € 1.090,00 1 019280006

1930LH

Omschakelbare slagmoersleutel
 • Dubbelhamer slagmechanisme



Onbelast toerental 6,000 rpm
 Max. aanhaalkoppel 2.441 Nm
 Bout capaciteit CI 8.8 M36 ● 55 mm
 Bout capaciteit CI 12.9 M30 ● 46 mm
 Luchtinlaat 1/2" GAS
 Werkdruk 6,2 bar
 Binnendiameter slang (Ø) 13 mm
 Gemiddeld luchtverbruik 280 l/min
 Gewicht 7,1 kg

1 7,1 € 1.360,00 1 019300030

1930CD

Omschakelbare slagmoersleutel, vervaardigd uit composiet materiaal
 • Dubbele hamer slagmechanisme



Onbelast toerental 4,000 rpm
 Max. aanhaalkoppel 2.445 Nm
 Bout capaciteit CI 8.8 M36 ● 55 mm
 Boutcapaciteit CI 12.9 M30 ● 46 mm
 Luchtaansluiting 1/2" GAS
 Werkdruk 6,2 bar
 Lucht slang binnen (Ø) 13 mm
 Gemiddeld luchtverbruik 320 l/min
 Gewicht 7,1 kg

1 7,1 € 1.465,00 1 019300022

1930PA

Omschakelbare slagmoersleutel
 • Dubbele hamer slagmechanisme



Onbelast toerental 3,500 rpm
 Max. aanhaalkoppel 2.445 Nm
 boutcapaciteit CI 8.8 M36 ● 55 mm
 boutcapaciteit CI 12.9 M30 ● 46 mm
 Luchtinlaat 1/2" GAS
 Werkdruk 6,2 bar
 Lucht slang binnen (Ø) 13 mm
 Gemiddeld luchtverbruik 350 l/min
 Gewicht 9,6 kg

1 9,6 € 1.315,00 1 019300032



1930LA

Omschakelbare slagmoersleutel

- "Dubbel hamer"-slagmechanisme

1"
CE



Onbelast toerental	4,000 rpm
Max. aanhaalkoppel	2.445 Nm
Bout capaciteit	CI 8.8 M36●55 mm
Bout capaciteit	CI 12.9 M30●46 mm
Luchtaansluiting	1/2" GAS
Werkdruk	6,2 bar
Luchtslang binnen (Ø)	13 mm
Gemiddeld luchtverbruik	460 l/min
Gewicht	10,6 kg

■	kg	€	1	019300037
1	10,6	1.415,00		

1930HLA

Omschakelbare moeraanzetter

- Dubbele hamer slagmechanisme

1"
CE



Onbelast toerental	3,000 rpm
Max. aanhaalkoppel	3.661 Nm
Bout capaciteit	CI 8.8 M42●65 mm
Bout capaciteit	CI 12.9 M33●50 mm
Luchtaansluiting	1/2" GAS
Werkdruk	6,2 bar
Luchtslang binnen (Ø)	13 mm
Gemiddeld luchtverbruik	460 l/min
Gewicht	16,4 kg

■	kg	€	1	019300040
1	16,4	1.985,00		

1931CD6

Omschakelbare lucht boormachine,
vervaardigd uit composiet materiaal

Ø6
CE



Onbelast toerental	2,600 rpm
Boorcapaciteit	1÷6 mm
Vermogen	0,23 kW
Schroefdraad boorkop	3/8" - 24UNF
Luchtaansluiting	1/4" GAS
Werkdruk	6,2 bar
Luchtslang binnen (Ø)	8 mm
Gemiddeld luchtverbruik	130 l/min
Gewicht	0,6 kg

■	kg	€	1	019310006
0,6		295,00		

1930A

Omschakelbare moeraanzetter

- Dubbel hamer slagmechanisme

1"
CE



Onbelast toerental	4,000 rpm
Max. aanhaalkoppel	2.445 Nm
Bout capaciteit	CI 8.8 M36●55 mm
Bout capaciteit	CI 12.9 M30●46 mm
Luchtaansluiting	1/2" GAS
Werkdruk	6,2 bar
Binnen diameter luchtslang (Ø)	13 mm
Gemiddeld luchtverbruik	460 l/min
Gewicht	9,5 kg

■	kg	€	1	019300036
1	9,5	1.330,00		

1930ZL

Omschakelbare moeraanzetter

- Dubbele hamer slagmechanisme

1 1/2"
CE



Onbelast toerental	3,000 rpm
Max. aanhaalkoppel	4.068 Nm
Bout capaciteit	CI 8.8 M42●65 mm
Bout capaciteit	CI 12.9 M36●55 mm
Luchtaansluiting	1/2" GAS
Werkdruk	6,2 bar
Luchtslang binnen (Ø)	13 mm
Gemiddeld luchtverbruik	480 l/min
Gewicht	15 kg

■	kg	€	1	019300070
1 1/2	15	2.490,00		

1931CD10

Omschakelbare lucht boormachine,
vervaardigd uit composiet materiaal

Ø10
CE



Onbelast toerental	1,800 rpm
Boorcapaciteit	1÷10 mm
Vermogen	0,38 kW
Schroefdraad boorkop	3/8" - 24UNF
Luchtaansluiting	1/4" GAS
Werkdruk	6,2 bar
Luchtslang binnen (Ø)	10 mm
Gemiddeld luchtverbruik	170 l/min
Gewicht	1 kg

■	kg	€	1	019310010
1,0		264,00		

1931CD13

Omschakelbare lucht boormachine,
vervaardigd uit composiet materiaal



Onbelast toerental	800 rpm
Boorcapaciteit	1,0÷13 mm
Vermogen	0,38 kW
Schroefdraad boorkop	1/2" - 20UNC
Luchtaansluiting	1/4" GAS
Werkdruk	6,2 bar
Luchtslang binnen (Ø)	10 mm
Gemiddeld luchtverbruik	170 l/min
Gewicht	1,3 kg

kg 1,3 € 383,00 1 019310013

1932B10

Omschakelbare lucht boormachine



Onbelast toerental	1,800 rpm
Boorcapaciteit	1÷10 mm
Vermogen	0,44 kW
Schroefdraad boorkop	3/8" - 24UNF
Luchtaansluiting	1/4" GAS
Werkdruk	6,2 bar
Luchtslang binnen (Ø)	10 mm
Gemiddeld luchtverbruik	160 l/min
Gewicht	1,2 kg

kg 1,2 € 203,00 1 019320040

1932B13

Omschakelbare luchtboormachine



Onbelast toerental	400 rpm
Boorcapaciteit	1,5÷13 mm
Vermogen	0,34 kW
Schroefdraad boorkop	1/2" - 20UNC
Luchtinlaat	1/4" GAS
Werkdruk	6,2 bar
Luchtslang binnen (Ø)	10 mm
Gemiddeld luchtverbruik	180 l/min
Gewicht	1,6 kg

kg 1,6 € 307,00 1 019320004

1931AN10

Omschakelbare haakse lucht boormachine



Onbelast toerental	1,400 rpm
Boorcapaciteit	1÷10 mm
Vermogen	0,38 kW
Schroefdraad boorkop	3/8" - 24UNF
Luchtaansluiting	1/4" GAS
Werkdruk	6,2 bar
Luchtslang binnen (Ø)	10 mm
Gemiddeld luchtverbruik	150 l/min
Gewicht	1,1 kg

kg 1,1 € 285,00 1 019310030

1932RS13

Omschakelbare lucht boormachine



Onbelast toerental	750 rpm
Boorcapaciteit	1,5÷13 mm
Vermogen	0,55 kW
Schroefdraad boorkop	3/8" - 24UNF
Luchtaansluiting	1/4" GAS
Werkdruk	6,2 bar
Luchtslang binnen (Ø)	10 mm
Gemiddeld luchtverbruik	160 l/min
Gewicht	1,4 kg

kg 1,4 € 255,00 1 019320043

1933IH

Stiftslijpmachine, hoog vermogen

- Stifhouders, Ø 3 mm en 6 mm



Onbelast toerental	20,000 rpm
Stift aansluiting	3 - 6 mm
Vermogen	0,75 kW
Luchtinlaat	1/4" GAS
Werkdruk	6,2 bar
Binnendiameter luchtslang (Ø)	10 mm
Gemiddeld luchtverbruik	370 l/min
Gewicht	800 g

g 800 € 236,50 1 019330006

Beta
Quality Tools

1933ILH

Stiftslijpmachine, hoog vermogen, lang model

- Stifthouders, Ø 3 mm en 6 mm

CE



Onbelast toerental	20,000 rpm
Stift aansluiting	3 - 6 mm
Vermogen	0,75 kW
Luchtinlaat	1/4" GAS
Werkdruk	6,2 bar
Binnendiameter luchtslang (Ø)	10 mm
Gemiddeld luchtverbruik	370 l/min
Gewicht	1,2 kg

kg 1,2 € 434,00 1 019330011

1933AN90-H

Haakse stiftslijpmachine, hoog vermogen

- Stifthouders, Ø 3 mm en 6 mm

CE



Onbelast toerental	15,000 rpm
Stift aansluiting	3 - 6 mm
Vermogen	0,75 kW
Luchtinlaat	1/4" GAS
Werkdruk	6,2 bar
Binnendiameter luchtslang (Ø)	10 mm
Gemiddeld luchtverbruik	370 l/min
Gewicht	1,1 kg

kg 1,1 € 436,00 1 019330021

1933

Lucht stiftslijpmachine

- Stifthouder in Ø 3 mm en 6 mm

CE



Onbelast toerental	25,000 rpm
Stift aansluiting	3 - 6 mm
Vermogen	0,20 kW
Luchtaansluiting	1/4" GAS
Werkdruk	6,2 bar
Luchtslang binnen (Ø)	10 mm
Gemiddeld luchtverbruik	230 l/min
Gewicht	380 g

g 380 € 156,00 1 019330001

1933I

Lucht stiftslijpmachine

- Stifthouders, Ø 3 mm en 6 mm

CE



Onbelast toerental	20,000 rpm
Stift aansluiting	3 - 6 mm
Vermogen	0,38 kW
Luchtaansluiting	1/4" GAS
Werkdruk	6,2 bar
Luchtslang binnen (Ø)	10 mm
Gemiddeld luchtverbruik	260 l/min
Gewicht	670 g

g 670 € 174,00 1 019330005

1933L

Lange stiftslijpmachine

- Stifthouders, Ø 3 mm en 6 mm

CE



Onbelast toerental	25,000 rpm
Stift aansluiting	3 - 6 mm
Vermogen	0,20 kW
Luchtaansluiting	1/4" GAS
Werkdruk	6,2 bar
Luchtslang binnen (Ø)	10 mm
Gemiddeld luchtverbruik	270 l/min
Gewicht	670 g

g 670 € 193,00 1 019330015

1933IL

Stiftslijpmachine, lang model

- Stifthouders, Ø 3 mm en 6 mm

CE



Onbelast toerental	20,000 rpm
Stift aansluiting	3 - 6 mm
Vermogen	0,38 kW
Luchtaansluiting	1/4" GAS
Werkdruk	6,2 bar
Luchtslang binnen (Ø)	10 mm
Gemiddeld luchtverbruik	113 l/min
Gewicht	1,4 kg

kg 1,4 € 243,50 1 019330010

1933AN90

Haakse stiftslijpmachine

- Stifthouders, Ø 3 mm en 6 mm

CE



Onbelast toerental	20,000 rpm
Stift aansluiting	3 - 6 mm
Vermogen	0,20 kW
Luchtaansluiting	1/4" GAS
Werkdruk	6,2 bar
Luchtslang binnen (Ø)	10 mm
Gemiddeld luchtverbruik	230 l/min
Gewicht	510 g

g 510 € 193,00 1 019330020

1934BV

Bandenpolijst machine, laagtoerig

- Stifthouders, Ø 3 mm en 6 mm

CE



Onbelast toerental	3,700 rpm
Boorcapaciteit	3 - 6 mm
Vermogen	0,37 kW
Luchtinlaat	1/4" GAS
Werkdruk	6,2 bar
Luchtslang binnen (Ø)	10 mm
Gemiddeld luchtverbruik	113 l/min
Gewicht	0,84 kg

g 840 € 212,00 1 019340000



1934MAV

Mini stiftslijpmachine

CE



Onbelast toerental	56,000 rpm
Stift aansluiting	3 mm
Vermogen	0,04 kW
Luchtinlaat	1/4" GAS BSPT
Werkdruk	6,2 bar
Lucht slang binnen (Ø)	4,5 mm
Gemiddeld luchtverbruik	115 l/min
Gewicht	0.2 kg

g 205 € 183,50 1 019340010

1934MAV70

Hoogtoerige micro stiftslijpmachine

CE



Onbelast toerental	70,000 rpm
Stift aansluiting	3 mm
Vermogen	0,08 kW
Luchtinlaat	1/4" GAS BSPT
Werkdruk	6,2 bar
Lucht slang binnen (Ø)	4,5 mm
Gemiddeld luchtverbruik	115 l/min
Gewicht	0.21 kg

g 210 € 310,00 1 019340030

1935F

Omschakelbare lucht schroevendraaier

1/4

CE



Onbelast toerental	800 rpm
Aanhaalkoppel	4-16 Nm
Schroefcapaciteit	6-9 M
Bit houder	● 1/4"
Luchtaansluiting	1/4" GAS
Werkdruk	6,2 bar
Lucht slang binnen (Ø)	10 mm
Gemiddeld luchtverbruik	150 l/min
Gewicht	1,3 kg

kg 1,3 € 283,00 1 019350045

1936/4A

Haakse slijpmachine

CE



Onbelast toerental	11,000 rpm
Schijfdiameter	115 mm
Vermogen	0,66 kW
Schroefdraad aansluiting	M14
Luchtinlaat	1/4" GAS
Werkdruk	6,2 bar
Lucht slang binnen (Ø)	10 mm
Luchtverbruik	390 l/min
Gewicht	1.77 kg

kg 1,8 € 483,00 1 019360024

1936/5A

Haakse slijpmachine

CE



Onbelast toerental	10,000 rpm
Schijfdiameter	125 mm
Vermogen	0,66 kW
Schroefdraad boorkop	M14
Luchtaansluiting	1/4" GAS
Werkdruk	6,2 bar
Lucht slang binnen (Ø)	10 mm
Gemiddeld luchtverbruik	390 l/min
Gewicht	1,9 kg

kg 1,9 € 483,00 1 019360025

1936/7A

Haakse slijpmachine

CE



Onbelast toerental	7600 giri/min
Schijfdiameter	180 mm
Vermogen	1,3 kW
Schroefdraad boorkop	M14
Luchtaansluiting	3/8" GAS
Werkdruk	6,2 bar
Lucht slang binnen (Ø)	13 mm
Gemiddeld luchtverbruik	906 l/min
Gewicht	2,7 kg

kg 2,7 € 695,00 1 019360027



1937
Orbitale handpalm schuurmachine, smering vrij, vervaardigd uit een composiet materiaal

• Orbit diameter: 5 mm



Onbelast toerental	12,000 rpm
Vermogen	0,18 kW
Schijfdiameter	150 mm
Orbit diameter	5 mm
Schroefdraad as	5/16" - 24
Luchtinlaat	1/4" GAS
Werkdruk	6,2 bar
Binnen diameter slang (Ø)	10 mm
Gemiddeld luchtverbruik	170 l/min
Gewicht	0,86 kg

kg	€		
0,86	512,00	1	019370001

1937R/P
6-gats schuurpad, Ø 150 mm, voor item 1937



kg	€		
0,86	62,50	1	019370002

1937KC
Mini roto-orbitale schuurmachine

- Orbitale uitslag 4 mm
- 2 steunpads (Ø 50 mm en Ø 75 mm)
- 10 schuurpapier schijven (Ø 50 mm), korrel 400, 600, 800
- 10 schuurpaperschijven (Ø 75 mm), korrel 400, 600, 800



Onbelast toerental	15000
Vermogen	0.25
Pad diameter	50 - 75
Schroefdraad aansluiting	M6 x 1.0
Luchtinlaat	1/4"
Werkdruk	6.2 bar
Binnen diameter luchtslang (Ø)	10
Gemiddeld luchtverbruik	79
Gewicht machine	0.64
Gewicht kit	1.4

kg	€		
1,4	299,00	1	019370171

1937C...
Schuurschijven voor artikel 1937KC



Ø mm	P	€		
50	400	20,10	1	019370175
50	600	20,10	1	019370176
50	800	20,10	1	019370177
75	400	26,50	1	019370178
75	600	26,50	1	019370179
75	800	26,50	1	019370180

* Prijzen zijn per 10 stuks

1937KL
Mini polijstmachine

- Steun pad (Ø 75 mm)
- 2 foam polijstpads (Ø 90 mm) - 1937/KL-DSB, 1937/KL-DSG
- Lamswollen pad (Ø 90 mm) - 1937/KL-DLA



Onbelast toerental	3,200 rpm
Vermogen	0.25 kW
Pad diameter	75 mm
Draadspindel	M6
Luchtinlaat	1/4" GAS
Werkdruk	6.2 bar
Binnendiameter slang (Ø)	10 mm
Gemiddeld luchtverbruik	91 l/min
Gewicht machine	0.75 kg
Gewicht van de kit	1.8 kg

kg	€		
1,8	323,00	1	019370161

1937KL-D
Toebehoren voor artikel 1937KL



	Ø mm	€		
1937KL-DLA	90	31,00	1	019370164
1937KL-DSB	90	31,00	1	019370165
1937KL-DSG	90	31,00	1	019370166

1937K...
Pads voor artikelen 1937KC en 1937KL



	Ø mm	1937KC	1937KL	€		
1937KC-RP	50	•		38,50	1	019370173
1937KL-RP	75	•	•	42,00	1	019370163

1937M
Schoor - polijstmachine met 16 toebehoren



Onbelast toerental	3,500 rpm
Vermogen	0.34 kW
Luchtaansluiting	1/4" GAS
Werkdruk	6.2 bar
Luchtslang binnen (Ø)	10 mm
Gemiddeld luchtverbruik	113 l/min
Gewicht schuurmachine	1,5 kg
Gewicht kit	4,5 kg

kg	€		
4,5	905,00	1	019370011

458x495x116 mm

1937M-01÷11
Toebehoren voor artikel 1937M



	L mm	1937M-	€		
1937M-01	30		36,50	1	019370101
1937M-02	30		36,50	1	019370102
1937M-03	11		31,00	1	019370103
1937M-04	23		31,00	1	019370104
1937M-05	11		31,00	1	019370105
1937M-06	23		31,00	1	019370106
* 1937M-07	16		89,50	1	019370107
1937M-08	13	07	31,00	1	019370108
1937M-09	26	07	31,00	1	019370109
1937M-10	11	03, 05	31,00	1	019370110
1937M-11	23	01, 02, 04, 06	31,00	1	019370111

* De afgebeelde prijzen zijn per 6 stuks

1937N10

Pneumatische bandschuurmachine



Onbelast toerental	20,000 rpm
Vermogen	0,37 kW
Bandmaat	10x330 mm
Luchtaansluiting	1/4" GAS
Werkdruk	6,2 bar
Lucht slang binnen (Ø)	10 mm
Gemiddeld luchtverbruik	374 l/min
Gewicht	0,9 kg

kg	€		
0,9	346,00	1	019370041

1937N10-GR

Schuurbanden voor artikel 1937N10



	P	€		
1937N10-GR60	60	39,50	1	019370146
1937N10-GR80	80	39,50	1	019370148
1937N10-GR100	100	39,50	1	019370150
1937N10-GR120	120	39,50	1	019370152

De afgebeelde prijzen zijn per 10 stuks

1937N20

Pneumatische bandschuurmachine



Onbelast toerental	16,000 rpm
Vermogen	0,45 kW
Bandmaat	20x520 mm
Luchtaansluiting	1/4" GAS
Werkdruk	6,2 bar
Lucht slang binnen (Ø)	10 mm
Gemiddeld luchtverbruik	400 l/min
Gewicht	1,6 kg

kg	€		
1,6	402,00	1	019370051

1937N20-GR

Schuurbanden voor artikel 1937N20



	P	€		
1937N20-GR60	60	51,50	1	019370156
1937N20-GR80	80	51,50	1	019370158
1937N20-GR100	100	51,50	1	019370160
1937N20-GR120	120	51,50	1	019370162

De afgebeelde prijzen zijn per 10 stuks

1938

Pneumatische ruitensnijder

• Geleverd met 1 57-mm recht mes

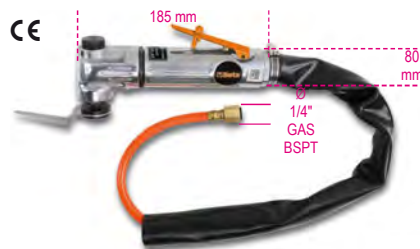

Bewegingen/minuut	20,000
Luchtinlaat	1/4" GAS
Werkdruk	6,2 bar
Binnen diameter slang (Ø)	6,5 mm
Gemiddeld luchtverbruik	200 l/min
Gewicht	1,0 kg

kg	€		
1,0	268,00	1	019380021

1938R/L

Messen voor pneumatische ruitensnijder

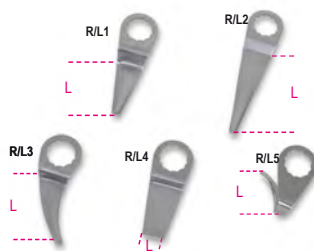

	L mm	€		
1938R/L1	57	24,10	1	019380041
1938R/L2	90	46,00	1	019380042
1938R/L3	30	29,00	1	019380043
1938R/L4	8	40,00	1	019380044
1938R/L5	36	45,50	1	019380045

1938R/S5

5-delig set messen voor item 1938

kg	€		
3,3	305,00	1	019400000

320x240x90 mm

1940

Lucht hakhamer

• Geleverd met een borgveer en snelwissel beitelhoeder voor beitels met een zeskant aansluiting



Slagen per minuut	3,500
Beitel aansluiting	Ø 11 mm
Zuiger diameter	19 mm
Slaglengte	67 mm
Luchtinlaat	1/4" GAS
Werkdruk	6,2 bar
Lucht slang binnen (Ø)	8 mm
Gemiddeld luchtverbruik	240 l/min
Gewicht	1,9 kg

kg	€		
1,9	208,00	1	019400001

1940/C6

Pneumatische hakhamer met 5 beitels en toebehoren

- Voor het doorhakken van plaatstaal, bouten en plaatwerk, verwijderen van laslakken, klinknagels, pleisterwerk en tegels
- Assortiment geleverd in een handige ABS koffer, bestaande uit:
 - 1 Perslucht hamer artikel 1940
 - 1 Platte beitel artikel 1940SN
 - 1 Ritsbeitel artikel 1940ST
 - 1 Ronde puntbeitel artikel 1940SD
 - 1 Puntlasbeitel artikel 1940SPS
 - 1 Snijbeitel artikel 1940SDT
 - 1 nonreturn spring item 1940MT
 - 1 bayonet retainer for hexagon chisels



Slagen per minuut	3,500
Beitel aansluiting	Ø 11 mm
Zuiger diameter	19 mm
Slaglengte	67 mm
Luchtinlaat	1/4" GAS
Werkdruk	6,2 bar
Binnendiameter slang (Ø)	8 mm
Gemiddeld luchtverbruik	240 l/min
Gewicht	3,3 kg

kg	€		
3,3	305,00	1	019400000

1940MT

Beitelhouder voor model 1940



1940MT	€ 15,90	5	019400110
--------	---------	---	-----------

1940S...

Beitels voor luchthamers 1940



1940SN	€ 18,20	5	019400020
1940ST	€ 18,20	5	019400021
1940SD	€ 18,20	5	019400022
1940SPS	€ 18,20	5	019400023
1940SDT	€ 18,20	5	019400024

1940/S5

5-delig set beitels voor luchthamers 1940



1940/S5	€ 83,00	1	019400030
---------	---------	---	-----------

1940E10

Pneumatische hakhamer

- Geschikt voor beitel met een 10-mm zeskant aansluiting
- Geleverd met een borgveer en snelwissel beitelhouder voor beitels met een zeskant aansluiting



Slagen per minuut	2,900
Beitel schacht	○ 10 mm
Piston diameter	19 mm
Slaglengthe	67 mm
luchtinlaat	1/4" GAS
Werkdruk	6.2 bar
Luchtslang binnen (Ø)	10 mm
Gemiddeld luchtverbruik	76 l/min
Gewicht	1.7 kg

kg	1,7	€	235,00	1	019400010
----	-----	---	--------	---	-----------

1940E10/MT

Reserve beitelhouder, veer model voor artikel 1940E10



1940E10/MT	€ 2,20	5	019400112
------------	--------	---	-----------

1940E10/S...

Beitels voor pneumatisch hamer 1940E10



1940E10/SN	€ 12,50	5	019400040
1940E10/ST	€ 12,50	5	019400041
1940E10/SD	€ 12,50	5	019400042
1940E10/SPS	€ 12,50	5	019400043
1940E10/SDT	€ 12,50	5	019400044

1940E10/S5

5 delig set beitels voor pneumatische hamer 1940E10



1940E10/S5	€ 62,50	1	019400050
------------	---------	---	-----------

1942A

Luchtzaag



Slagen per minuut	10.000
Slaglengthe	10 mm
Luchtinlaat	1/4" GAS BSP
Werkdruk	6.2 bar
Luchtslang binnen (Ø)	8 mm
Gemiddeld luchtverbruik	75 l/min
Gewicht	550 g

g	550	€	352,00	1	019420000
---	-----	---	--------	---	-----------

1942LR

Bimetalen zaagbladen voor luchtzaag artikel 1942A



1942LR	€ 9,00	5	019420032
--------	--------	---	-----------

1944A

Rechte naaldenbikhamer

CE



Slagen per minuut	3.800
Slaglengthe	33 mm
Aantal naalden	19
Naalden afmeting (Ø)	3 mm
Lucht inlaat	1/4" GAS
Werkdruk	6.2 bar
Luchtslang binnen (Ø)	10 mm
Gemiddeld luchtverbruik	113 l/min
Gewicht	2.6 kg

kg	2,8	€	400,00	1	019440011
----	-----	---	--------	---	-----------

1944N

Naaldenbikhamer



Slagen per minuut	3800
Slaglengthe	33 mm
Aantal naalden	19
Naalden afmeting (Ø)	3 mm
Luchtinlaat	1/4" GAS
Werkdruk	6.2 bar
Binnendiameter slang (Ø)	8 mm
Gemiddeld luchtverbruik	85 l/min
Gewicht	2.7 kg

kg	2,7	€	503,00	1	019440002
----	-----	---	--------	---	-----------

1944AR

Naalden voor naaldenbikhamer model 1944A - 1944N



1944AR 2	Ø mm	2	n.	29	€	58,00	1	019440015
1944AR 3	Ø mm	3	n.	19	€	45,00	1	019440005

1944PA

Naaldenhouder voor artikelen 1944N en 1944A



	Ø mm	N	€		
1944PA 2	2	29	64,00	1	019440016
1944PA 3	3	19	52,00	1	019440006

1945S

Pneumatische nietmachine

• Werkt met krammen type 80, sectie 0.95 x 0.65 mm (21-G), lengte: 4 - 16 mm; breedte: 12.8 mm



Magazijn capaciteit	157 pcs
Slangaansluiting	1/4" GAS
Werkdruk	4.2 - 7 bar
Binnenmaat luchtslang (Ø)	8 mm
Luchtverbruik (7 bar)	0.34 l/cycle
Gewicht	0.87 kg

kg	€		
0,9	214,50	1	019450000

1945S/G...

Krammen type 80, sectie 0.95x0.65 mm (21-G), breedte 12.8 mm, voor artikel 1945S

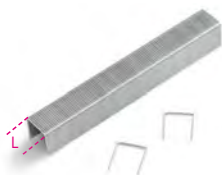

	L mm	€		
• 1945S/G 4	4	22,40	1	019450004
1945S/G 6	6	8,55	1	019450006
1945S/G 8	8	9,70	1	019450008
1945S/G 10	10	10,70	1	019450010
1945S/G 12	12	11,90	1	019450012
1945S/G 14	14	12,90	1	019450014
1945S/G 16	16	14,50	1	019450016

Afgebeelde prijzen zijn voor 5,000 stuks
• Afgebeelde prijzen zijn voor 10,000 stuks

1945C

Pneumatische combitacker

• Werkt met krammen type 90, sectie 1.25 x 1.0 mm (18-G), lengte: 16 - 40 mm; breedte: 5.8 mm
• Werkt met ronde kop nagels type B12, sectie 1.25 x 1.0 mm (18-G), 1.9-mm kop



Magazijn capaciteit	100 pcs
Slangaansluiting	1/4" GAS
Werkdruk	5 - 8 bar
Binnenmaat luchtslang (Ø)	8 mm
Luchtverbruik (7 bar)	1.12 l/cycle
Gewicht	1.16 kg

kg	€		
1,16	307,00	1	019450200

1945C/G...

Krammen type 90, sectie 1.25x1.0 mm (18-G), breedte 5.8 mm, voor artikel 1945C

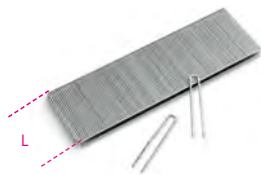

	L mm	€		
• 1945C/G 16	16	17,20	1	019450216
1945C/G 19	19	20,30	1	019450219
1945C/G 22	22	22,40	1	019450222
1945C/G 25	25	26,50	1	019450225
1945C/G 28	28	27,50	1	019450228
1945C/G 32	32	32,00	1	019450232
1945C/G 35	35	35,00	1	019450235
1945C/G 38	38	39,50	1	019450238
1945C/G 40	40	41,50	1	019450240

Afgebeelde prijzen zijn voor 5,000 stuks

1945C/GP...

Nagels type B12, sectie 1.25x1.0 mm (18-G), 1.9 mm-kop, voor artikel 1945C

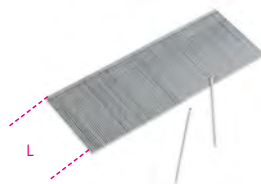

	L mm	€		
• 1945C/GP 15	15	9,00	1	019450255
1945C/GP 16	16	9,35	1	019450256
1945C/GP 20	20	11,00	1	019450260
1945C/GP 25	25	12,70	1	019450265
1945C/GP 30	30	14,90	1	019450270
1945C/GP 32	32	16,40	1	019450272
1945C/GP 35	35	17,40	1	019450275
1945C/GP 38	38	19,10	1	019450278
1945C/GP 40	40	19,50	1	019450280
1945C/GP 45	45	21,50	1	019450285
1945C/GP 50	50	23,60	1	019450290

Afgebeelde prijzen zijn voor 5,000 stuks



1945P

Pneumatische tacker

• Werkt met nagels type B6, Ø 0.64 mm (23-G), lengte: 12 - 35 mm



Magazijn capaciteit	145 pcs
Slangaansluiting	1/4" GAS
Werkdruk	4 - 7 bar
Binnenmaat luchtslang (Ø)	8 mm
Luchtverbruik (7 bar)	0.27 l/cycle
Gewicht	0.87 kg

kg	€		
0,87	340,00	1	019450100

1945P/S...

Nagels type B6, Ø 0.64 mm (23-G), voor artikel 1945P



	L mm	€		
• 1945P/S 12	12	10,50	1	019450112
1945P/S 15	15	11,40	1	019450115
1945P/S 18	18	12,60	1	019450118
1945P/S 20	20	14,50	1	019450120
1945P/S 21	21	14,70	1	019450121
1945P/S 22	22	15,00	1	019450122
1945P/S 25	25	16,40	1	019450125
1945P/S 30	30	18,70	1	019450130
1945P/S 35	35	21,30	1	019450135

Afgebeelde prijzen zijn voor 10,000 stuks



1946

Pneumatische blindklinktang

- Geleverd met verwisselbare mondstukken; 2,4-3,2-4,0-4,8 mm rond, een nagelopvang en ophangbeugel

CE



Trekkraft	8000 N
Slaglengte	14 mm
Max. nagel capaciteit	Luchtslang binnen Ø 4,8 mm
Luchtaansluiting	1/4" GAS
Werkdruk	6,2 bar
Luchtslang binnen (Ø)	6 mm
Gemiddeld luchtverbruik	1.2 l/ciclo
Gewicht	1,5 kg

kg	€		
1,5	211,00	1	019460001

1946C4,8

Pneumatisch blindklinktang

- automatische afzuijing
- geleverd met mondstukken voor 2,4-3,2-4,0-4,8 mm lange nagels voor staal, roestvast staal, aluminium en koperen nagels.

CE



Trekkraft	8,900 N
Slaglengte	15 mm
Max. nagelcapaciteit	Roestvaststaal Ø 4.8 mm
Luchtinlaat	1/4" GAS
Werkdruk	6,2 bar
Luchtslang binnen (Ø)	10 mm
Luchtverbruik	2.6 l/cycle
Gewicht	1.5 kg

kg	€		
1,5	675,00	1	019460006

1946C7,8

Pneumatisch blindklinktang

- automatische afzuijing
- geleverd met mondstukken voor 4,8-5,6-6,4-7,8 mm lange nagels voor staal, roestvast staal, aluminium en koperen nagels.

CE



Trekkraft	16,900 N
Slaglengte	22.5 mm
Max. nagelcapaciteit	Roestvaststaal Ø 7.8 mm
Luchtinlaat	1/4" GAS
Werkdruk	6,2 bar
Luchtslang binnen (Ø)	10 mm
Luchtverbruik	4.9 l/cycle
Gewicht	1.8 kg

kg	€		
1,8	1.050,00	1	019460008

1946C/T...

Mondstukken voor basis nagels



	Ø mm	€		
1946C/T4,8	4,8	43,00	1	019460016
1946C/T6,4	6,4	43,00	1	019460018

1946KF

Pneumatische blindmoertang

- Geleverd met mondstukker voor klinkmoeren uit staal, roestvast staal, aluminium en koper, M4, M5, M6, M8

CE



Trekkraft	14,235 N
Slaglengte	7 mm
Max. nagel capaciteit	Roestvast staal Ø, M8
Luchtinlaat	1/4" GAS
Werkdruk	6,2 bar
Luchtslang binnen (Ø)	10 mm
Luchtverbruik	2.1 l/cycle
Gewicht	2.1 kg
Gewicht (kit)	3.4 kg

kg	€		
3,4	2.335,00	1	019460012

1946KF/M...

Reserve pennen voor artikel 1946KF



	€		
1946KF/M4	84,00	1	019460124
1946KF/M5	84,00	1	019460125
1946KF/M6	84,00	1	019460126
1946KF/M8	80,50	1	019460128

1947

Pneumatische kitspuit

- Pneumatische spuit voor medium dichte silicone kit en lijmen
- Geschikt voor standaard kokers (210 x 50 mm), hard en zacht

CE



Koker afmeting	210x50 mm
Koker capaciteit	350 ml
Luchtaansluiting	1/4" GAS
Werkdruk	4.8 bar
Luchtslang binnen (Ø)	10 mm
Gemiddeld luchtverbruik	120 l/min
Gewicht	1,1 kg

kg	€		
1,1	79,00	1	019470001

1947H

Pneumatische kitspuit

- Pneumatische kitspuit voor het spuiten van siliconekit en lijmen uit standaard kunststof of aluminium kokers
- Geschikt voor standaard kokers (215/218 x 50/51 mm), hard en zacht
- Ingebouwde drukregelaar

CE



Koker afmeting	210x50 mm
Koker capaciteit	300/310 ml
Luchtaansluiting	1/4" GAS
Werkdruk	4 ÷ 8 bar
Luchtslang binnen (Ø)	2.5 mm
Gemiddeld luchtverbruik	120 l/min
Gewicht	750 g

g	€		
750	273,00	1	019470011



1947G

Pneumatisch vetpistool

Gegoten aluminium behuizing
 Ergonomische handgreep, noodzakelijk voor moeilijk te bereiken vetnippels
 Corrosie bestendige koperen klep
 Geschikt voor 400 g vetpatronen of los vet tot 500 cc
 Kokerafmeting: 54 (inwendig) x 260 mm
 Luchtinlaat: 1/4" GAS
 Werkdruk: 4÷10 bar
 Gewicht: 1.9 kg

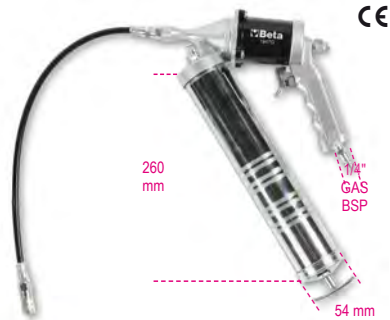

1947G € 191,50 1 019470051

1947G2

2-in-1 pneumatische vetspuit

Voor continue of niet-continue vetaanvoer
 Gegoten aluminium behuizing
 Ergonomische handgreep
 Geschikt voor 400 g patronen of vet in bulk tot 500 cc



Slangmaat 54 (binnenkant) x 276 mm
 Luchtinlaat 1/4" GAS BSP
 Werkdruk 3÷10 bar
 Gewicht 2,2 kg

1947G2 € 196,50 1 019470060

1948

Graveerpen

• Hiermee kunnen materialen als staal, roestvrij staal, aluminium, glas, steen en keramiek worden gemarkeerd



Slagen per minuut 3,500 ÷ 3,800
 Maximale hardheid 60 HRC
 Luchtinlaat 1/4" GAS
 Werkdruk 6.2 bar
 Gemiddeld luchtverbruik 50 l/min
 Gewicht 150 g

150 € 331,00 1 019480001

1948PR

Reserve tungsten stalen graveerstift voor artikel 1948

• Maximale hardheid: 60 HRC



1948PR € 160,50 1 019480005

1949XS

Progressief blaaspistool

• Gemaakt van lichtmetaal
 • Luchtstroom kan worden aangepast door de kop te draaien

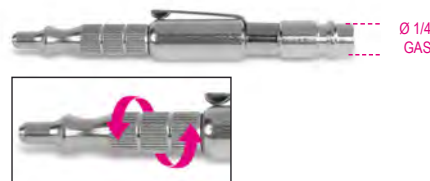

Luchtinlaat 1/4" GAS
 Werkdruk 3-8 bar
 Maximale werkdruk 10 bar
 Werktemperatuur -20 °C ÷ 70 T38°C
 Gewicht 20 g

20 € 9,00 25 019490025

1949U5

Progressief blaaspistool met 5 mondstukken

• Duurzaam, schokbestendig composiet behuizing
 • 3 stalen mondstukken, 100/160/320 mm, krasvast beschermend rubber blaasmond
 • 1 "Turbo" mondstuk vervaardigd uit glasfiber versterkt nylon met veiligheids blaasmond
 • 1 draaibare mondstuk, 100 mm, vervaardigd uit glasfiber versterkt nylon
 • Voorzien van een snelkoppeling systeem



Koperen luchtinlaat 1/4" GAS
 Werkdruk 10 bar
 Maximale werkdruk 15 bar
 Gemiddeld luchtverbruik 280 l/min
 Werktemperatuur -10°C ÷ 85°C
 Gewicht 93 g

93 € 46,00 1 019490030

1949U5/A

Stalen mondstuk, 100 mm, krasvast, beschermende rubber tip, voor artikel 1949U5 - 1949P



1949U5/A € 9,35 1 019490131

1949U5/B

Stalen mondstuk, 160 mm, krasvast, beschermende rubber tip, voor artikel 1949U5 - 1949P



1949U5/B € 9,50 1 019490132

1949U5/C

Stalen mondstuk, 320 mm, krasvast, beschermende rubber tip, voor artikel 1949U5 - 1949P



1949U5/C € 11,90 1 019490133

1949U5/D

Draaibaar mondstuk, 100 mm, vervaardigd uit glasfiber versterkt nylon, voor artikel 1949U5 - 1949P



1949U5/D € 8,70 1 019490134

Beta

1949U5/E

"Turbo" mondstuk, vervaardigd uit glasfiber versterkt nylon, met veiligheids blaasmond



1949U5/E € 4,35 1 019490135

1949U5/F

Platte waaivormige spuitmond, vervaardigd uit nylon, versterkt met glasfiber voor artikelen 1949U5 en 1949P



1949U5/F € 5,40 1 019490136

1949U5/G

OSHA mondstuk, vervaardigd uit nylon, versterkt met glasfiber voor artikelen 1949U5 en 1949P



1949U5/G € 4,10 1 019490137

1949BC

Progressief blaaspistool met rubber mondstuk

- Duurzaam, schokbestendig behuizing uit composiet materiaal
- Vervangbaar krasvast rubber mondstuk



Aluminium luchtinlaat 1/4" GAS
Werkdruk 6-8 bar
Maximale werkdruk 15 bar
Gemiddeld luchtverbruik 87 l/min
Werktemperatuur -20°C ÷ 70°C
Gewicht 120 g

120 g € 22,00 1 019490022

1949BC/RUL

5 lange mondstukken met rubberen uiteinden, voor artikel 1949BC



1949BC/RUL € 29,00 1 019490123

1949P

Progressief mini blaaspistool

- Duurzaam, schokbestendig compositete behuizing
- Snelwissel systeem van de blaasmond
- Luchtstroom is instelbaar door het draaien van de ring

Ø 1/4" GAS BSPT



Koperen luchtinlaat 1/4" GAS
Werkdruk 6÷8 bar
Maximale werkdruk 15 bar
Gemiddeld luchtverbruik 280 l/min
Werktemperatuur -10 °C ÷ 85 °C
Gewicht 70 g

70 g € 29,00 1 019490031

1949T

Telescopische progressief blaaspistool

- Duurzaam, schokbestendig behuizing uit composiet materiaal
- Telescopische stalen mondstuk: 165 mm ÷ 300 mm

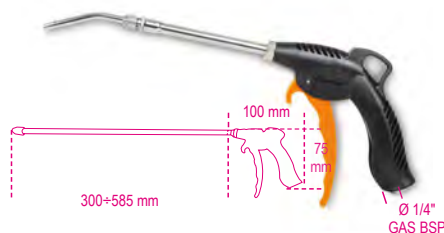

Aluminium luchtinlaat 1/4" GAS
Werkdruk 6-8 bar
Maximale werkdruk 15 bar
Gemiddeld luchtverbruik 144 l/min
Werkdruk -20°C ÷ 70°C
Gewicht 190 g

190 g € 35,00 1 019490040

Beta

1949F2

Progressief blaaspistool

- Gemaakt van slijtvast, schokbestendig, krasbestendig, thermisch geïsoleerd composiet kunststofmateriaal
- Speciale klep en hendel zorgen ervoor dat het circuit geleidelijk kan worden geopend, waardoor de luchtstroom wordt geoptimaliseerd
- Tip met veiligheidskegel van kunststof voor veilig gebruik wanneer niet in gebruik



Messing inzetstuk met schroefdraad 1/4" GAS
Werkdruk 4-8 bar
Maximale werkdruk 12 bar
Werktemperatuur -20 °C ÷ 70 °C
Gewicht 125 g

125 g € 20,80 1 019490028

1949GPA

bandenpomp

- schokbestendige, met rubber beklede behuizing
- metalen bedieningshendel
- bedrijfsdruk: 0,5÷12 bar, 7÷174 psi
- drukontlastingsfunctie
- drukmeetfunctie
- pijplengte: 58 cm
- 360° slangrotatie
- 1/4" luchtinlaat



1949GPA bar psi € 132,00 1 019490018

1949DGT/2

digitale bandenpomp

- schokbestendige, met rubber beklede behuizing
- metalen bedieningshendel
- werkdruk: 0,5÷12 bar, 7÷174 psi
- 4 meeteenheden, bar/psi/kpa/kgf
- LCD-scherm met achtergrondverlichting
- resolutie: 0,05 bar
- automatisch uitschakelen na 1,5 minuut
- slanglengte: 58 cm
- 360° slangrotatie
- voeding: 2 AAA-batterijen
- 1/4" luchtinlaat



L= 560 mm

Ø 1/4" GAS BSP

CE

1949DGT/2 $\frac{\text{bar}}{0,5\div 12}$ $\frac{\text{psi}}{7\div 174}$ € 159,50 1 019490021

1949GPN

Bandenpomp, ABS behuizing

- CE gecertificeerd manometer met schaal verdeling 0.7÷12 bar (graduatie: 1/10 bar)
- Twee servo-controle knopen verzorgen een nauwkeurig en snel opblazen (+) of afblazen (-)
- Geleverd met een calibratie certificaat
- Voorzien van een schokbestendig en beschermend omhulsel met een ophangoog
- Aansluiting voor 1/4" GAS draad koppeling
- Draaibaar luchtinlaat voor rubberslang, Ø 7 mm



245 mm

Ø 4 mm

L=1500 mm

CE

1949GPN $\frac{\text{bar}}{0,7\div 12}$ $\frac{\text{g}}{810}$ € 268,00 1 019490011

1949M

Bandenpomp



L=350mm

60 mm

1949M $\frac{\text{bar}}{0\div 4}$ $\frac{\text{psi}}{5\div 60}$ $\frac{\text{g}}{280}$ € 95,00 1 019490400

1949R

Blaaspistool voor het reinigen van radiatoren

De 5 gaten die loodrecht op de handgreep staan blazen het vuil van de radiatoren



L mm 600 $\frac{\text{mm}}{6}$ € 74,00 1 019490050

1950BZK

Airbooster

- Zij-handgreep met drukknopbediening helpt het gereedschap tijdens gebruik vast te houden
- tankinhoud: 18 l
- bedrijfsdruk: 3-8 bar
- maximale tankdruk: 16 bar
- Drukventiel
- meter met schaalverdeling
- kunststof inlaat voorkomt velgbeschadiging

CE



1950BZK € 321,00 1 019500078



1951

Reinigingspistool

- Voor het schoonmaken van autobekleding, vloermatten, stoelen en laarzen



319 mm

125 mm

Ø 1/4" GAS BSP

Onbelast toerental

Tank inhoud 1 L
Luchtaansluiting 1/4" GAS
Werkdruk 6,2 bar
Binnendiameter luchtslang (Ø) 8 mm
Gemiddeld luchtverbruik 110 l/min
Gewicht 650 g

$\frac{\text{g}}{650}$ € 157,00 1 019510051

1951A

Reinigingspistool met afzuiging

- Voor het schoonmaken van autobekleding, vloermatten, stoelen en laarzen
- Te gebruiken met geschikte schoonmaakmiddelen
- 1L Beker
- Voorzien van een kraan voor het legen van de beker
- Compleet met geribbelde slang, 1,8 m lang



340 mm

125 mm

Ø 1/4" GAS BSP

Beker inhoud

Luchtinlaat 1 l
Werkdruk 6,2 bar
Binnendiameter slang (Ø) 8 mm
Gemiddeld luchtverbruik 120 l/min
Gewicht 800 g

$\frac{\text{g}}{800}$ € 260,00 1 019510101

1952

Professionele verfspuit

- Gegoten aluminium huis gelakt met zwarte chemische nikkel
- Nylon beker met druppel opvang, 3/8M BSP schroefdraad
- Luchtinlaat: 1/4" BSP cilindrische gasdraad
- Druk en luchtverbruik regelateur
- Sproeikop instelbaar voor rond tot verneveling spuiten
- Instelbaarheid verf volume
- Geleverd met service sleutel voor onderhouds werkzaamheden

CE



	Ø mm	€		
1952 1,2	1,2	181,50	1	019520012
1952 1,5	1,5	181,50	1	019520015
1952 1,8	1,8	181,50	1	019520018
1952 2,0	2,0	181,50	1	019520020

1900S

automatische veerslanghaspel, schokbestendig plastic lichaam, voor gebruik met lucht of water

- max. werkdruk: 15 bar
- gevlochten polyurethaanslang
- polypropyleen frame
- apparaat voor het automatisch bevestigen van slang op gewenste lengte
- vergrendelsysteem kan worden uitgeschakeld.
- bedrijfstemperatuurbereik: -5 °C / +50 °C
- geleverd met een 180° draaibare beugel en een extra snelkoppelingsbeugel

CE



D1xD	L	Ø GAS	€		
mm	m	BSP			
1900S 8X10	8x12	10 1/4"	199,00	1	019000080

1900M

slag kit voor het verwijderen van injectoren

- max. werkdruk: 15 bar
- gevlochten polyurethaanslang
- polypropyleen frame
- mogelijkheid voor het automatisch bevestigen van slang op gewenste lengte
- vergrendelsysteem kan worden uitgeschakeld.
- bedrijfstemperatuurbereik: -5 °C / +50 °C
- geleverd met een 180° draaibare beugel en een extra snelkoppelingsbeugel

CE



D1xD	L	Ø GAS	€		
mm	m	BSP			
1900M 8X15	8x12	15 1/4"	273,00	1	019000085
1900M 10X15	10x14	15 3/8"	283,00	1	019000115

1914

Polyuretheen spiraalslangen, 98 Shore, uitrekbaar

- Maximale werkdruk: 12 bar



L	D1xD	Ø GAS	€		
m	mm	BSP			
4	5x8	1/4"	29,50	1	019140054
6	5x8	1/4"	35,50	1	019140056
10	5x8	1/4"	44,00	1	019140060

1915B

polyuretheen spiraalslang, 95 Shore, uitrekbaar tot 9 meter

- Maximale werkdruk: 10 bar

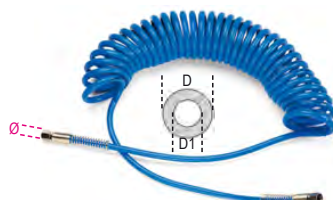

D1xD	Ø GAS	€		
mm	BSP			
6,5x10	1/4"	54,50	1	019150011
8x12	1/4"	63,00	1	019150012

1915C

polyuretheen spiraalslang, 95 Shore, uitrekbaar tot 12 meter

- Maximale werkdruk: 10 bar

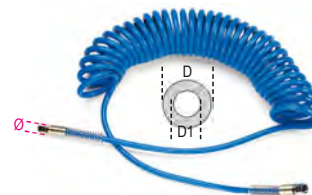

D1xD	Ø GAS	€		
mm	BSP			
6,5x10	1/4"	60,50	1	019150014
8x12	1/4"	77,00	1	019150015

1915C/L

Polyuretheen spiraalslangen, 98 Shore, uitrekbaar tot 15 meter

- Maximale werkdruk: 10 bar

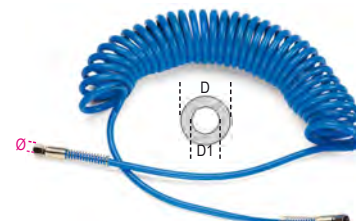

D1xD	Ø GAS	€		
mm	BSP			
8x12	1/4"	100,00	1	019150115
11x16	3/8"	170,50	1	019150116

1915D

Gevlochten polyuretheen slang, 95 Shore, 9 meter lang

- Maximale werkdruk: 15 bar



D1xD	Ø GAS	€		
mm	BSP			
8x12	1/4"	67,50	1	019150017

1915E

Gevlochten polyuretheen slang, 95 Shore, 12 meter lang

- Maximum operating pressure: 15 bar



D1xD	Ø GAS	€		
mm	BSP			
8x12	1/4"	87,50	1	019150019
11x16	3/8"	128,00	1	019150020

1915E/XL

Gevlochten polyuretheen slang, 95 Shore, 50 meter lang

• Maximale werkdruk: 15 bar



D1xD	Ø GAS	€	5	1
mm	BSP			
8x12	1/4"	289,00	1	019150519
11x16	3/8"	485,00	1	019150520

1916I

Insteeknippels, Italiaans profiel uitwendige draad, cilindrisch (BSP)



Ø GAS	€	5	1
BSP			
1/4"	3,60	5	019160001
3/8"	4,05	5	019160002

1916G

Insteeknippel Europees profiel uitwendige draad, taps (BSPT)



Ø GAS	€	5	1
BSPT			
1/4"	3,60	5	019160005
3/8"	4,65	5	019160010
1/2"	5,55	5	019160012

1916GF

Insteeknippel, Italiaans profiel, inwendige draad, cilindrisch (BSP)



Ø GAS	€	5	1
BSP			
1/4"	3,60	5	019160055
3/8"	4,05	5	019160060

1916GFE

Insteeknippel, Europees profiel, inwendige draad, taps (BSPT)



Ø GAS	€	5	1
BSPT			
1/4"	3,70	5	019160075
3/8"	4,95	5	019160082
1/2"	5,45	5	019160084

1916JM

Snelkoppeling, Aziatisch profiel, buitendraad, taps (BSPT)



Ø GAS	€	1	1
BSPT			
1/4"	5,00	1	019160406
3/8"	5,45	1	019160410

1916JF

Snelkoppelingen, Europees profiel, inwendige draad, cilindrisch (BSPT)



Ø GAS	€	1	1
BSPT			
1/4"	5,00	1	019160456
3/8"	5,45	1	019160460

1916P

Snekoppeling, Italiaanse profiel, met pasdeel voor rubber slang



D1xD	€	5	1
mm			
6x14	4,90	5	019160256
8x17	5,25	5	019160258
10x19	6,95	5	019160260

1916S

Insteeknippels, Italiaans profiel, met anti knikveer

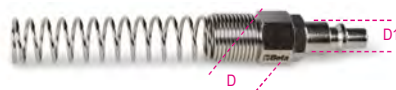

D1xD	€	5	1
mm			
6x8	4,90	5	019160306
8x10	5,15	5	019160308
10x12	6,55	5	019160310

1917M

Universele snelkoppelingen, schokbestendig rubber, uitwendige draad, cilindrisch (BSP)

• Passend op insteeknippel 1916I en 1916G



Ø GAS	€	5	1
BSP			
1/4"	13,80	5	019170001
3/8"	13,80	5	019170003
1/2"	14,70	5	019170004

1917F

Universele snelkoppeling, schokbestendig rubber, inwendige draad, cilindrisch (BSP)

• Past op insteeknippels 1916I en 1916G



Ø GAS	€	5	1
BSP			
1/4"	14,30	5	019170005
3/8"	13,80	5	019170010
1/2"	15,10	5	019170014

1917JM

Snelkoppeling, Aziatisch profiel, uitwendig draad, cilindrisch (BSP)



Ø GAS	€	1	1
BSP			
1/4"	20,90	1	019170406
3/8"	20,90	1	019170410
1/2"	22,50	1	019170412

1917JF

Snelkoppeling, Aziatisch profiel, inwendig draad, cilindrisch (BSP)



Ø GAS	€	1	1
BSP			
1/4"	20,90	1	019170456
3/8"	20,90	1	019170460

1917RG

Draaibare universele koppeling

- Vervaardigd uit aluminium, inwendig draad, cilindrisch (BSP)
- uitwendig draad, cilindrisch (BSP)
- Is geschikt voor alle insteeknippels met een Italiaans of Europees profiel
- Draait probleemloos, zelfs zonder aangesloten te zijn.



Ø GAS	€	1	1
BSP			
1/4"	27,50	1	019170252

1917SP

Universele snelkoppeling,
met deel voor rubber slang



D1xD	mm	€			
6x14		14,40	5	019170206	
8x17		14,90	5	019170208	
10x19		17,20	5	019170210	

1917ST

Universele snelkoppeling,
met anti knikveer



D1xD	mm	€			
6x8		13,70	5	019170306	
8x10		13,50	5	019170308	
10x12		15,40	5	019170310	

1918

Slangpilaar, uitwendige draad



D1	Ø GAS	mm	BSP	€			
6	1/8"		BSP	2,98	3	019180106	
8	1/8"		BSP	2,98	3	019180108	
6	1/4"		BSP	3,30	3	019180116	
8	1/4"		BSP	3,55	3	019180118	
10	1/4"		BSP	3,55	3	019180120	
10	3/8"		BSP	3,95	3	019180130	
12	3/8"		BSP	4,05	3	019180132	
10	1/2"		BSP	5,40	3	019180140	
12	1/2"		BSP	5,55	3	019180142	

1918N

Verbindingsnippels
met tapse draad (BSPT)



Ø	Ø1	GAS	GAS	€			
1/4"	1/4"			3,55	5	019180300	
3/8"	3/8"			4,05	5	019180310	
1/2"	1/2"			5,50	5	019180320	

1918R

Verloopnippels
met tapse draad (BSPT)



Ø	Ø1	GAS	GAS	€			
1/4"	3/8"			3,95	5	019180200	
3/8"	1/2"			5,40	5	019180210	

1919FE1/4

Filter-reduceerventiel-olienevelaar



Lucht in/uitlaat		1/4" GAS BSPT
Lucht aansluiting manometer		1/8" GAS BSPT
Maximale lucht doorstroom		750 l/min
Maximale druk		9,5 bar
Werkdruk		0,5 - 8,5 bar
Werktemperatuur		5 - 60 °C
Filter capaciteit		5 micron
Beker inhoud		15 cc air / 25 cc oil
Gewicht		700 g

g	€		
700	150,50	1	019190200

1919RB-FE1/4

Set van reserve bekertjes
voor model 1919FE1/4



g	€		
700	31,00	1	019190210

1919RF-FE1/4

Reserve filter voor model 1919FE1/4



g	€		
700	9,00	1	019190230

1919RM-FE1/4

Reserve manometer
voor model 1919FE1/4



g	€		
700	16,70	1	019190220

1919F1/4

Filter-reduceerventiel-olienevelaar



Lucht in/uitlaat		1/4" GAS BSPT
Maximale lucht doorstroom		1000 l/min
Maximale druk		9,5 bar
Werkdruk		0,5 - 8,5 bar
Werktemperatuur		5 - 60 °C
Filter capaciteit		5 microns
Beker inhoud		60 cc air / 90 cc oil
Gewicht		1,3 kg

kg	€		
1,3	223,50	1	019190250

Beta

1919F3/8

Filter-reduceerventiel-olienevelaar



Lucht in/uitlaat 3/8" GAS BSPT
 Maximale lucht doorstroom 1350 l/min
Maximale druk 9,5 bar
 Werkdruk 0,5 - 8,5 bar
Werktemperatuur 5 - 60 °C
 Filter capaciteit 5 microns
Beker inhoud 60 cc air / 90 cc oil
 Gewicht 1.3 kg

kg 1,3 € 223,50 1 019190350

1919F1/2

Filter-reduceerventiel-olienevelaar



Lucht in/uitlaat 1/2" GAS BSPT
 Maximale lucht doorstroom 2500 l/min
Maximale druk 9,5 bar
 Werkdruk 0,5 - 8,5 bar
Werktemperatuur 5 - 60 °C
 Filter capaciteit 5 microns
Beker inhoud 60 cc air / 90 cc oil
 Gewicht 1.3 kg

kg 1,3 € 223,50 1 019190450

1919RB-F

Set van reserve bekers voor model 1919F - 1/4", 3/8" en 1/2"



€ 42,00 1 019190510

1919RF-F

Reserve filter voor model 1919F - 1/4", 3/8" en 1/2"



1919RF-F € 15,20 1 019190530

1919RM-F

Reserve manometer voor model 1919F - 1/4", 3/8" en 1/2"



1919RM-F € 23,60 1 019190520

1919ML

Mini olienevelaars



Ø	L mm	Ø mm	€	1
1/4"	63	36	25,50	1 019190030
3/8"	63	36	27,50	1 019190032

1919SC

Mini waterafscheider



Ø	L mm	Ø mm	€	1
1/4"	80	40	33,00	1 019190035

1919L

ISO 32 smeeroilie

Dichtheid 20°C 875 Kg/m³
 Viscositeit 40°C 32 cSt
 Ontbrandingspunt COC 210°C



cc 500 € 25,00 5 019190050



GEREEDSCHAPWAGENS EN ASSORTIMENTEN

			GEREEDSCHAPSKOFFERS									GEREEDSCHAPSTASSEN												TROLLEY													
			2009N/BV	2028/VV	2029/VV	2032/TV	2033L/VV	2036/TV	C99	C99V1	C99V3/2C	C4	C5	C5S	C6T	C9MT	C7	C8	C10	C9	C10S	C11	CP15L	C16	CP17L	C12	C14	CP15	C18	C19	C19L	C20	C20L	C41S	C41H	C42H	
Aantal																																					
5914VU/M	Universeel onderhoud	109																																			
5915VU/0	Universeel onderhoud	35										498																									
5915VU/1	Universeel onderhoud	45																																			
5915VU/2	Universeel onderhoud	49																																			
5915VU/3	Universeel onderhoud	74																																			
5915VU/4	Universeel onderhoud	80																																			
5915VU/5	Universeel onderhoud	111																																			
5915VU/AS	Universeel onderhoud	68																																			
5940SBK	Motorfiets onderhoud	125																																			
5941VU/M	Universeel onderhoud	64																																			
5980EL/A	Elektronica	57		514		514	514																														
5980EL/B	Elektronica	98			515		515	515																													
5980ET/A	Elektronica	70		512		512																															
5980ET/B	Elektronica	64			513		513	513																													
5980ID/1	Loodgieters onderhoud	24	516									516																									
5980MQ	Elektronica	46			513																																
5980U/BIKE	Motorfiets onderhoud	90																																			
5990V1	Universeel onderhoud	44							505	505																											
5990V3	Autoreparatie	116							505		505																										

GEREEDSCHAPSTASSEN EN RUGZAKKEN VAN TECHNISCHE TEXTIEL

- FUNCTIONALITEIT
- STEVIGHEID
- DUURZAAMHEID

Dit zijn de drie hoekstenen van het assortiment zachte gereedschapstassen van Beta.

De gereedschapstassen en rugzakken van Beta zijn gemaakt van stevig technisch materiaal, bestand tegen slijtage en slijtage, met versterkte bodems en naden, wat zich vertaalt in betrouwbaarheid en duurzaamheid.

Elke tas heeft speciale kenmerken, ontworpen voor verschillende toepassingen en optimalisatie van de ruimte:

vakken met ritssluiting, telescopische handgrepen, wielbeschermers, versterkte schouderbanden en transparante documentenvakken zijn slechts enkele van de bijzonderheden van elke tas en rugzak.

Zorgvuldige aandacht voor detail, variatie en speciale aandacht voor het volledig veilige transport van de gereedschappen maken deze producten ideaal voor elke werksituatie.



POLYPROPYLEEN GEREEDSCHAPSKOFFERS

Beta biedt een breed scala aan technische koffers die aan elke behoefte voldoen!

De gereedschapskoffers en trolleys van Beta zijn gemaakt van stevig, dik, schokbestendig, corrosiebestendig polypropyleen, ontworpen voor intensief gebruik - bijv. bij lage temperaturen.

Kies het product dat het beste bij uw werkvereisten past: de klassieke gereedschapswagen, de trolleyversie met wielen voor eenvoudig transport, de

versies met TSA-sloten voor volledig vrij reizen en tot slot de aluminium of waterdichte versie.

De meeste gereedschapskoffers en trolleys van Beta zijn ook verkrijgbaar in combinatie met gereedschapsassortimenten die voldoen aan verschillende werkbehoefte, afhankelijk van het toepassingsgebied: elektronica, hydraulica, boten en onderhoud.



2001/B26

Stoffen etui met 26-delig assortiment gereedschappen



2001/B26 € 262,00 1 020010215

55 6x7 - 8x9 - 10x11 - 12x13 - 14x15 - 16x17 mm
 96N/SC9 1,5 - 2 - 2,5 - 3 - 4 - 5 - 6 - 8 - 10 mm
 1128BMX 145 mm
 1150 180 mm
 1201E 3x75 - 4x100 - 5,5x150 mm
 1202E PH1x80 - PH2x100 mm
 1370 300 g
 1692 2 m
 1770A 9 mm

2001/BV € 65,00 1 020010051

2001/BZV

Gereedschapstas vervaardigd uit duurzaam technisch materiaal

- Dubbel hengsel voor optimale grip
- Groot documentenvak aan voorzijde met ritssluiting
- Klittenband aan achterkant voor het bevestigen van de tas aan een trolley handgreep
- 20 handige gereedschap opbergvakken (6 zakken en 14 elastieke houders)
- Hamer lus
- Schouder draagriem C9/RT kan meegeleverd worden (apart te bestellen)



2001/BZV € 56,00 1 020010151

380x290x60 mm - 675 g



2001/BZ24 MQ

Roltas met 24-delig assortiment, voor elektriciens



2001/BZ24 MQ € 339,00 1 020010154

	n.
1128BMX	1
1150MQ 180 mm	1
42 8-10-13-17-19 mm	5
1274MQ 3x100 - 4x100 - 5,5x125 mm	3
1272MQ PH0x60 - PH1x80 - PH2x100 mm	3
96BP/SC9 1,5-2-2,5-3-4-5-6-8-10 mm	9
1253	1
1082MQ 160 mm	1

2001/BZ27 VU

Roltas met 27-delig assortiment, voor universeel gebruik



2001/BZ27 VU € 308,00 1 020010157

	n.
1128BMX	1
1150 180 mm	1
42 7-8-10-13-17-19 mm	6
1201E 3x75 - 4x100 - 5,5x150 mm	3
1202E PH0x60- PH1x80 - PH2x100 mm	3
96/SC9 1,5-2-2,5-3-4-5-6-8-10 mm	9
1370 300 g	1
1048N 250 mm	1
1692/5 5 m	1
1771 18 mm	1

2002/BV6

Foudraal van duurzaam polyester, leeg

- Met 6 handige gereedschapsvakken van verschillende grootte
- Centrale handgreep van versterkte stof maakt het gemakkelijk te dragen
- Met binnenklep om te voorkomen dat gereedschap naar buiten komt
- Versterkingsnaden over de hele omtrek van de tas
- Dubbele klittenbandsluiting
- Afmetingen geopend: 175 x 240 mm



2002/BV6 € 10,20 1 020020000

2002/BVL6

Foudraal van duurzaam polyester, leeg

- Met 6 handige gereedschapsvakken van verschillende grootte
- Centrale handgreep van versterkte stof voor comfortabel dragen
- Met binnenklep om te voorkomen dat gereedschap naar buiten komt
- Versterkingsnaden over de hele omtrek van de tas
- Dubbele klittenbandsluiting
- Afmetingen geopend: 220 x 290 mm



2002/BVL6 € 13,00 1 020020010

2002/BV7-ZIP

Foudraal van duurzaam polyester, leeg

- Met 7 handige compartimenten van verschillende grootte en een klein gereedschapszakje met ritssluiting
- Centrale handgreep van versterkte stof voor comfortabel dragen
- Met binnenklep om te voorkomen dat gereedschap naar buiten komt
- Versterkingsnaden over de hele omtrek van de tas
- Dubbele klittenbandsluiting
- Afmetingen in geopende toestand: 355 x 220 mm



2002/BV7-ZIP € 23,30 1 020020060

2002/BV8

Foudraal van duurzaam polyester, leeg

- Met 8 handige gereedschapsvakken van verschillende afmetingen
- Centrale handgreep van versterkte stof voor comfortabel dragen
- Met binnenklep om te voorkomen dat gereedschap naar buiten komt
- Versterkingsnaden over de hele omtrek van de tas
- Dubbele klittenbandsluiting
- Afmetingen in geopende toestand: 395 x 360 mm



2002/BV8 € 13,00 1 020020020

2002/BV9

Foudraal van duurzaam polyester, leeg

- Met 9 handige gereedschapsvakken van verschillende afmetingen
- Centrale handgreep van versterkte stof voor comfortabel dragen
- Met binnenklep om te voorkomen dat gereedschap naar buiten komt
- Versterkingsnaden over de hele omtrek van de tas
- Dubbele klittenbandsluiting
- Afmetingen geopend: 325 x 290 mm



2002/BV9 € 13,00 1 020020030

2002/BV12

Foudraal van duurzaam polyester, leeg

- Met 12 handige gereedschapsvakken van verschillende afmetingen
- Centrale handgreep van versterkte stof voor comfortabel dragen
- Met binnenklep om te voorkomen dat gereedschap naar buiten komt
- Versterkingsnaden over de hele omtrek van de tas
- Dubbele klittenbandsluiting
- Afmetingen in geopende toestand: 650 x 355 mm



2002/BV12 € 21,70 1 020020040

2002/BV13

Foudraal van duurzaam polyester, leeg

- Met 13 handige gereedschapsvakken van verschillende afmetingen
- Centrale handgreep van versterkte stof voor comfortabel dragen
- Met binnenklep om te voorkomen dat gereedschap naar buiten komt
- Versterkingsnaden over de hele omtrek van de tas
- Dubbele klittenbandsluiting
- Afmetingen in geopende toestand: 330 x 190 mm"



2002/BV13 € 13,00 1 020020050

2002/BV42

oprolbare gereedschapstas van duurzaam polyester, leeg

- Met 42 handige gereedschapsvakken van verschillende afmetingen:
- 18 elastische banden en 24 zakken, waaronder een zak met riemflap
- Centrale handgreep van versterkte stof maakt het gemakkelijk te dragen
- Kan aan de muur worden opgehangen door middel van metalen ringen
- Versterkingsnaden over de hele omtrek van de foudraal
- Stevige sluiting met dubbele clipgesp
- Afmetingen geopend: 595 x 535 mm



2002/BV42 € 31,00 1 020020070

2005MPU

gereedschapstas, leeg, van nylon, met riem

- Vijf grote gereedschapsvakken
- Een schaar-vak aan de voorkant
- Gesp met karabijnhaak voor plakband
- Verstelbare riem (70 ÷ 120 cm)

Afmetingen: 155x285x80 mm



2005MPU € 33,50 1 020050060

2005MPU/E

gereedschapstas met assortiment van 5 gereedschappen



2005MPU/E € 105,00 1 020050065

1128BMX

1150BM 180 mm

1201E 3,5x100 - 4x100 mm

1202E PH1x80 mm

155x285x80 mm

2005PA/D

Nylon gereedschaphouder met riem. Leeg.



2005PA/D € 75,00 1 020050000

2005PA/E

gereedschapstas, leeg, van nylon, met riem

- Twee grote vakken met elastische gereedschapsbanden
- Twee schaar-vakken aan de voorkant
- Twee handige zijvakken met:
 - linkerzak met stevige metalen haak voor meetlinten
 - dubbele rechter zak met tas met trekkoord en ritssluiting
- Gesp met karabijnhaak voor plakband
- Verstelbare riem (70 ÷ 120 cm)

Afmetingen: 260x250x190 mm



2005PA/E € 51,00 1 020050030

2005PA/ET

gereedschapstas met assortiment van 8 gereedschappen voor elektrotechnisch onderhoud



2005PA/ET € 183,50 1 020050035

1082MQ 160 160 mm

1128BMX

1253

1272MQF PH1x80 - PH2x100

1274MQF 3,5x100 - 4,5x100

1639ESB BMESB1925NE

260x250x190 mm

2005PA/S

Nylon gereedschaphouder met riem. Leeg.



2005PA/S € 36,50 1 020050020

2009N/BV

Lederen onderhoudstas



2009N/BV € 334,00 1 020090200

530x220x190 mm

2005PA/U

Gereedschapstas met assortiment van 17 gereedschappen voor universeel gebruik



2005PA/U € 204,50 1 020050040

96/SC9

111E 200 mm

1048N 250 mm

1128BMX

1201E 4x100 - 5,5x125 mm

1202E PH1x80 - PH2x100 mm

1692/3 3 m

≡ 260x250x190 mm

2028/VV

Gereedschapskoffer, vervaardigd uit polypropyleen
2 gereedschaps panelen
Bodemdeel voorzien van uitneembare vakverdeling
Dubbel combinatie slot



2028/VV € 277,00 1 020280010

≡ 480x190x400 mm

2028E

Gereedschapskoffer met een assortiment gereedschap voor elektrisch en elektronica onderhoud



2028EL/A € 1.290,00 1 020281014

2028ET/A € 1.295,00 1 020281018

(2028/VV+5980ET/A)

2029/VV

Gereedschapskoffer, vervaardigd uit dik polypropyleen,
aluminium frame

2 gereedschapspanelen

Bodemschaal voorzien van uitneembare en instelbare vakverdeling

Geleverd met schouder draagriem

dubbele slot met sleutel



2029/VV € 375,00 1 020290000

≡ 480x227x408 mm

2029E

Gereedschapskoffer met assortiment voor elektrisch en elektronica onderhoud



2029 BG MQ € 2.145,00 1 020291257

(2029/VV+5980MQ)

2029ET/B € 1.705,00 1 020291021

(2029/VV+5980ET/B)

2029EL/B € 1.805,00 1 020291017

(2029/VV+5980EL/B)

2029EM

Gereedschapskoffer met assortiment onderhouds-en reparatiegereedschappen voor hybride en elektrische voertuigen



2029EM € 2.155,00 1 020290300

52MQ 7-8-9-10-11-12-13-14-15-16-17-19-22 mm

910MQ/B 6-7-10-12-13-17-19 mm

910MQ/TX TX25 - TX30 - TX40

910MQ/55

1048MQ 250 mm

1082MQ 160 mm

1128MQ 145 mm

1150MQ 180 mm

1162MQ 160 mm

1272MQ PH1 - PH2

1274MQ 2,5x75 - 3x100 - 4x100 - 5,5x125 - 6,5x150 mm

1760PT

1777MQ/U 190 mm

1996MQ/GM GM 10

7109A A1 - A2

7109D D2 - D3

2032/TV

Gereedschapskoffer, vervaardigd uit kunststof

2 gereedschapspanelen
Gereedschapsvak
Bodem voorzien van uitneembare vakverdeling



2032/TV € 491,00 1 020320110

≡ 450x200x400 mm



2032/TE

Verrijdbare gereedschapskoffer met gereedschappen voor elektrisch en elektronica onderhoud



2032TET/A
(2032/TV+5980ET/A)

€ 1.510,00 1 020321328

2033L/VV

gereedschapskoffer, gemaakt van aluminium, leeg



2033L/VV

€ 413,00 1 020330250

470x203x373 mm

2033L

Aluminium gereedschapskoffer met gereedschap assortiment voor elektronica en elektrotechnisch onderhoud



2033LEL/A
(2033L/VV+5980EL/A)

€ 1.430,00 1 020331224

2033LEL/B
(2033L/VV+5980EL/B)

€ 1.845,00 1 020331225

2033LET/B
(2033L/VV+5980ET/B)

€ 1.745,00 1 020331237

2036/TV

Verrijdbare gereedschapskoffer, vervaardigd uit dik polypropyleen, aluminium frame

2 gereedschapspanelen
Telescopische handgreep
Kogelgelagerde wielen



2036/TV

€ 597,00 1 020360000

480x267x408 mm

2036E

Verrijdbare gereedschapskoffer met assortiment voor elektrisch en elektronica onderhoud



2036TET/B
(2036/TV+5980ET/B)

€ 1.930,00 1 020361223

2036EL/B
(2036/TV+5980EL/B)

€ 2.030,00 1 020361218

2037/TV

Verrijdbare gereedschapskoffer, vervaardigd uit dik polypropyleen, met vier zwenkwielen

Sterk schokbestendig. Geschikt voor transport van gereedschap in het vliegtuigruim.
2 uitneembare gereedschapspanelen.
Ingebouwd documentvak.
4 afneembare zwenkwielen voor horizontaal vervoer.
2 sorteerbakjes meegeleverd
2 TSA goedgekeurde sloten met sleutels
Rubber-beklede handgreep



2037/TV

€ 796,00 1 020370000

482x295x478 mm

2038/TV

Verrijdbare gereedschapskoffer, vervaardigd uit dik polypropyleen

- Zeer schokbestendig
- Aluminium sluit profiel
- 2 TSA goedgekeurde sloten met sleutels
- 2 uitneembare gereedschapspanelen.
- Telescopische handgreep en grote kogelgelagerde wielen
- 2 ergonomisch gevormde rubber handgrepen (inclusief 1 zij handgreep)
- Volumineus bodemvak
- Document houder
- 3 verdeel laden



2038/TV

€ 949,00 1 020380000

430x375x525 mm



2041UC

Koffer met een 33-del. Assortiment gereedschappen



2041UC € 391,00 1 020410215

- 55 6x7 - 8x9 - 10x11 - 12x13 - 14x15 - 16x17 mm
- 96/SC9 1,5 - 2 - 2,5 - 3 - 4 - 5 - 6 - 8 - 10 mm
- 111E 200 mm
- 1048VN 250 mm
- 1128BMX 145 mm
- 1150 180 mm
- 1201E 2,5x50 - 3x75 - 4x100 - 5,5x100 - 6,5x150 mm
- 1202E PH0x60 - PH1x80 - PH2x100 mm
- 1370 300 g
- 1692 3m
- 1771 170 mm
- 1833S 70 Lumen / 140 mm
- 1639NS-N 25m
- 1696 200 mm

535x282x87 mm - 4,5 Kg

2051N

Assortiment van 55 gereedschappen voor nautisch onderhoud in schokbestendige polypropyleen koffer



2051N € 917,00 1 020510225

- 42 7 - 8 - 10 - 12 - 13 - 14 - 17 - 19 mm
- 55AS 3/8x7/16 - 1/2x9/16 - 5/8x11/16"
- 96/SC9 \varnothing 1,5+10 mm
- 111E 200 mm
- 920A \varnothing 10 - 12 - 13 - 14 - 17 - 19 mm
- 920AS \varnothing 7/16 - 1/2 - 9/16 - 11/16 - 7/8"
- 920/22 255 mm - \square 1/2 - \blacksquare 1/2
- 920/25 \square 1/2 - \blacksquare 1/2
- 920/42 \blacksquare 1/2
- 920/55 \blacksquare 1/2
- 956C \square 1/2 - 16 - 20,8 mm
- 1048BM 250 mm
- 1084BM 160 mm
- 1128BMX 145 mm
- 1150BM 180 mm
- 1166BM 160 mm
- 1201E \bullet 3x75 - 4x100 - 5,5x150 - 6,5x150 mm
- 1202E \oplus PH1x80 - PH2x100 mm
- 1390 \varnothing 35 mm
- 1490/2 \varnothing max 240 mm
- 1737 145 mm
- 1778X

BMN1436 3,6 x 140 mm

BMESB1925E 25 m

585x393x92 mm - 9 kg

2055HB

"Home Bag" kunststof koffer met 24-delig assortiment gereedschappen



2055HB € 234,50 1 020550215

- 55 6x7 - 8x9 - 10x11 - 12x13 mm
- 96N/SC9 1,5 - 2 - 2,5 - 3 - 4 - 5 - 6 - 8 - 10 mm
- 1128BMX 145 mm
- 1150 180 mm
- 1048VN 250 mm
- 1201E 3x75 - 4x100 - 5,5x100 mm
- 1202E PH0x60 - PH1x80 - PH2x100 mm
- 1370 300 g
- 1692 3m

373x275x70 mm - 3 Kg

2080/V6

Koffer met 6 uitneembare assortimentsdoosjes en instelbare vakverdeling



2080/V6 mm € 45,50 1 020800060

2080/V6-U

Uitneembare assortimentsdoosje voor koffer artikel 2080/V6



2080/V6-U € 3,45 1 020800066

90x60x50 mm

2080/D10

10-delig set van verdeelschotjes voor assortimentskoffer 2080/V6



2080/D10 € 8,70 1 020800070

2080/V12

Koffer met 12 uitneembare assortimentsdoosjes



2080/V12 mm € 69,00 1 020800000

2080/V12-...

Uitneembare assortimentsdoosje voor artikel 2080/V12



2080/V12-S € 4,30 3 020800013

95x75x65 mm
2080/V12-M € 6,40 2 020800015

145x75x65 mm
2080/V12-L € 11,20 1 020800020

295x75x65 mm

C3

Mini gereedschapstas, vervaardigd uit technisch textiel

Belangrijkste kenmerken:

- 1 voorvak aan de buitenkant met ritssluiting
- 2 zijzakken met bakjes
- 1 handig achterzakje met klittenbandsluiting
- 1 uitneembaar gereedschapspaneel aan de binnenkant met elastische banden aan beide zijden
- USB-interface voor het opladen van mobiele apparaten
- Compleet met schouderband

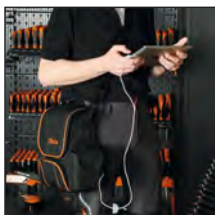

C3	€ 73,50	1	021030000
≡ 230x110x320 mm - 890 g			

C4 - 2104

Gereedschapstas, vervaardigd uit technisch textiel

Uitneembaar gereedschapspaneel

Vakken aan binnen en buitenzijde met elastiek

Robuuste en waterafstotende bodemplaat met rubber doppen

Geleverd met schouder draagriem



C4	€ 125,00	1	021040000
2104VU/0	€ 578,00	1	021041122
(C4+5915VU/0)			
≡ 330x260x360 mm - 2,5 kg			

C5S

Rugzak voor gereedschap, vervaardigd uit slijtvast polyester

- Dubbele handgreep boven voor een stevig gebalanceerd dragen
- Twee grote vakken aan voorzijde
- Twee ruime binnenvakken en 2 extra klittenband houders
- Handige oprolvak binnenzijde, samengesteld uit 4 gereedschaps panelen
- Verstelbare versterkte schouderriemen
- Maximale draagcapaciteit: 15 kg



C5S	€ 63,50	1	021050100
≡ 310x120x390 mm - 0,9 Kg			

C5 - 2105

Rugzak voor gereedschap, vervaardigd uit textiel



C5	€ 174,00	1	021050000
2105VU/0	€ 627,00	1	021051122
(C5+5915VU/0)			
≡ 400x200x500 mm - 2,5 Kg			

C6T - 2106

Gereedschapstas, vervaardigd uit textiel



C6T	€ 251,00	1	021060010
2106T/VU0	€ 704,00	1	021061123
(C6T+5915VU/0)			
≡ 360x200x480 mm - 4,5 kg			

C7 - 2107

Gereedschapstas, uit technische textiel

2 uitneembare gereedschapspanelen

Binnenzijde heeft een ruimte voor PC

2 zakken aan buitenzijde

Binnen bodem is vervaardigd uit kunststof, met uitneembare vakverdeling



C7	€ 260,00	1	021070000
2107VU/2	€ 738,00	1	021071112
(C7+5915VU/2)			
2107VU/3	€ 1.240,00	1	021071114
(C7+5915VU/3)			
≡ 480x165x380 mm - 3,5 kg			

C7AT

Onderhoudsgereedschapstas van technische stof

Belangrijkste kenmerken:

- gemaakt van superduurzaam technisch materiaal
- versterkte basis met rubberen voetjes
- dubbele handgreep aan de bovenkant voor een veilige, evenwichtige grip
- groot documentenvak aan de voorkant met ritssluiting en extra compartiment met dubbele riem + clipsluiting
- Dubbel zijvak met riemsluiting
- ruim binnenvak met extra documentenvak
- PC- en tabletvak met beschermende binnenvoering (PC-formaat tot L=370 mm, H=250 mm)
- Ritsopening aan de voorkant aan beide zijanten van de tas voor snelle toegang tot gereedschap:
- 29 vakken en 13 elastische gereedschapsbanden aan de voorkant;
- 33 gereedschapsvakken aan de achterzijde.
- compleet geleverd met verstelbare gewatteerde schouderband



C7AT

€ 135,00 1 021070010

≡ 470x200x340 mm

C8 - 2108

Mobiele gereedschapstas vervaardigd uit technisch textiel



€ 297,00 1 021080000
 € 826,00 1 021081022

≡ 470x280x380 mm - 4 kg

C8B

Vrijdare gereedschapstas, vervaardigd uit technisch textiel, voor de elektriciens

Hard frame

Telescopisch handvat

4 zwenkwielen

1 uitneembaar gereedschapspaneel aan de binnenkant

Voorvak met badgehouder

Dubbele bodem compleet met bakje

2 zijvakken aan de buitenkant

2 haken

Kantelbare handgreep voor gemakkelijkere toegang tot gereedschap

Kan met een hangslot worden vergrendeld (hangslot niet inbegrepen)



C8B

€ 235,00 1 021080300

≡ 380x250x430 mm - 4,7 kg

C9 - 2109

Gereedschapstas, vervaardigd uit technisch textiel

• Harde bodemplaat

• Vakken aan binnen en buitenkant

• Buitenvak met ritssluiting voor extra veiligheid

• Vak met klittenbandsluiting voor persoonlijke bezittingen

• Dubbele bodem

• Dubbele banden voor waterpas

• Schouder draagriem voor eenvoudiger transport



€ 143,00 1 021090000
 € 672,00 1 021091022
 € 1.124,00 1 021091024

≡ 550x280x320 mm - 2,6 kg

C9/RT

Schouder draagriem voor items C4, C7, C9, C10, C10S, C11 e C12



C9/RT

€ 18,80 1 021090900

C9DA

gereedschapstas met grote opening

Belangrijkste kenmerken:

- gemaakt van superduurzaam technisch materiaal
- harde kunststof basis, waterbestendig
- versterkte handgreep aan de bovenkant voor een veilige grip
- Dubbel zijvak met riemsluiting
- twee gereedschapsvakken aan de zijkant met grote openingen, voor snelle toegang tot en perfect zicht op de inhoud
- 22 gereedschapsvakken en extra compartiment met ritssluiting aan de voorkant
- 14 gereedschapsvakken en extra compartiment met ritssluiting aan de achterkant
- compleet geleverd met verstelbare gewatteerde schouderband



C9DA

€ 125,00 1 021090005

≡ 420x220x310 mm

 **Beta**

C9MT

Gereedschapstas voor algemeen onderhoud

- Stevige PVC hoes, waterdicht
- verstevigingsnaden rond de hele omtrek
- dubbele clip gespsluiting
- dubbele handgreep aan de binnenkant voor een veilige, evenwichtige grip
- documentenvak met rits



C9MT € 93,00 1 021090200

450x180x200 mm

2109MT ID/1

Gereedschapstas met assortiment van 24 sanitairgereedschap



2109MT ID/1 € 716,00 1 021091026
(C9MT+5980ID/1)

- 111E 250 mm
- 332 Ø 3+28 mm
- 334 Ø 3+30 mm
- 342 Ø 0+42 mm
- 345SB2 140 mm
- 376 320-410 mm
- 1048N 175-250 mm
- 1128BMX
- 1150GBM 180 mm
- 1201E 3x75-4x100-5,5x150-8x150 mm
- 1202E PH1x80-PH2x100
- 1370 500 g
- 1690F 2 m
- 1692/5 5 m
- 1696 200 mm
- 1719BMA...M 200 mm
- 1719BM/RL 200 mm
- 1725

Beta

C9PT



C9PT 321

C10 - 2110

Gereedschapstas, vervaardigd uit technisch textiel

- Hard bodemplaat
- Dubbele bodem. Het bodemdeel is uitneembaar voor het vergroten van de opbergcapaciteit
- Wegklapbare handgreep vergroot de ingang van de tas voor het eenvoudig uitnemen van gereedschappen
- Elastieke gereedschapshouders en vakken aan binnen en buitenkant
- Afdekklep
- Onderdelenbak verwerkt in de dubbele bodem



C10 € 185,50 1 021100000
2110VU/1 € 714,00 1 021101031
(C10+5915VU/1)
2110VU/3 1.167,00 1 021101034
(C10+5915VU/3)
2110VU/AS 1.270,00 1 021101036
(C10+5915VU/AS)

520x220x250 mm - 3,3 kg

C10S - 2110S

Gereedschapstas, vervaardigd uit technisch textiel

- Hard bodemplaat
- Dubbele bodem. Het bodemdeel is uitneembaar voor het vergroten van de opbergcapaciteit
- Wegklapbare handgreep vergroot de ingang van de tas voor het eenvoudig uitnemen van gereedschappen
- Elastieke gereedschapshouders en vakken aan binnen en buitenkant
- Afdekklep
- Onderdelenbak verwerkt in de dubbele bodem



C10S € 144,00 1 021100001
2110SVU/1 € 673,00 1 021101041
(C10S+5915VU/1)
2110SVU/3 1.125,00 1 021101044
(C10S+5915VU/3)

420x220x250 mm - 2,3 kg

C11 - 2111

Gereedschapsbak, vervaardigd uit textiel



C11 € 106,50 1 021110000
2111VU/1 € 635,00 1 021111031
(C11+5915VU/1)
2111VU/3 1.088,00 1 021111034
(C11+5915VU/3)

410x230x250 mm - 2 kg





C12 - 2112

Gereedschapstas, uit technische textiel

Uitneembaar gereedschapspaneel
Elastieke gereedschapshouders en volumineuze binnen en buitenzakken
Tas opent aan voorzijde voor eenvoudige toegang tot de gereedschappen op de werkplek
Harde, waterafstotende bodem met rubber steunen
Kan gebruikt worden in combinatie met mobiele tas C8



	€		
C12	225,50	1	021120000
2112ET/A (C12+5980ET/A)	1.245,00	1	021121028
2112ET/B (C12+5980ET/B)	1.560,00	1	021121029
2112VU/5 (C12+5915VU/5)	1.490,00	1	021121056

500x270x350 mm - 5 kg

C13

gereedschapskoffer met wielen, gemaakt van slijtvast polypropyleen

- Geschikt voor buitengebruik
- Schokbestendig, bestand tegen chemische middelen
- Kan worden vergrendeld met een hangslot (hangslot niet inbegrepen)
- Dubbele sluiting
- Twee wielen voor horizontale hantering van gereedschapskoffer
- Met binnenbak die kan worden verwijderd en in twee standen kan worden vergrendeld
- Naamplaten



	€		
C13	370,00	1	021130000

806x350x467 mm - 7,2 kg

C14

Mobiele gereedschapskoffer, vervaardigd uit polypropyleen, met 4 laden

- Geinjecteerde polypropyleen behuizing voor een hogere weerstand tegen schokken.
- De voorzijde is afgeschermd door een klep en is voorzien van 4 uittrekbare laden (470x255):
1 laden 30 mm hoog
2 laden 60 mm hoog
1 lade 90 mm hoog
- Centraal veiligheidsslot aan voorzijde maakt het mogelijk het voorste en bovenste gedeelte gelijktijdig af te sluiten.
- Twee handgrepen aan beide zijden
- 4 robuuste wielen achterzijde
- Uitneembare gereedschapsbak
- Gereedschapspaneel in de deksel
- 3 sorteerbakjes meegeleverd
- Naamplaatje
- Kan tevens afgesloten worden met een TSA slot



	€		
C14	944,00	1	021140000
2114VU/M (C14+5914VU/M)	2.150,00	1	021141011

585x390x457 mm - 10 kg

CP15 - 2115

Gereedschapskoffer, vervaardigd uit kunststof, uitneembare inlegbak en sorteerbakjes

- 1 vakje in de deksel
- 2 uitneembare sorteerdoosjes met verdeling
- 1 uitneembare inlegbak met instelbare verdeling



	€		
CP15	56,50	1	021150201
2115PVU/1 (CP15+5915VU/1)	585,00	1	021151232
2115PVU/2 (CP15+5915VU/2)	534,00	1	021151234

445x240x250 mm - 2 kg

CP15L - 2115

Gereedschapskoffer, vervaardigd uit kunststof, uitneembare inlegbak en sorteerbakjes

- 3 vakken in de deksel met instelbare verdeling
- 1 uitneembare inlegbak met instelbare verdeling



	€		
CP15L	75,50	1	021150202
2115PL-VU/1 (CP15L+5915VU/1)	604,00	1	021151242
2115PL-VU/3 (CP15L+5915VU/3)	1.057,00	1	021151245

558x277x270 mm - 2,5 kg

2115PI/BIKE-HOME

Assortiment van 28 gereedschappen

Fietsonderhoud



	€		
2115PI/BIKE-HOME	297,00	1	021150098

96BP/SC9
3935
3969K3
42 8-9-10-13-14 mm
42SLIM 15 mm
1082G 160 mm
1150G 180 mm
1201E 3x75 - 5,5x150 mm
1202E PH0x60 - PH2x100 mm
3991

BMESB1925NE 25 mm
BMN1436 3,6 x 140 mm

558x277x270 mm - 4,3 kg



2115P L-MQ32

32-delig assortiment van geïsoleerde gereedschappen voor hybride wagens, in kunststof koffer met voorgevormde foam inlegbak



2115PL-MQ32 € 1.235,00 1 021150332

- 920MQ/55A
- 89MQ 10-12 mm
- 850MQ 1/4"
- 860TX/A10 T7-T8-T9-T10-T15-T20-T25-T27-T30-T40
- 920MQ/A 8-10-12-13-14-17-19 mm
- 920MQ/21 125mm
- 920MQ/22 250mm
- 1048MQ250 250mm
- 1150MQ 180mm
- 1164MQ160 160mm
- 1272MQ 4.5X80-6X100mm
- 1274MQ 3X100-4X100-5.5X125
- 1995MQ/G2 G2
- CP15L

C16 - 2116

Gereedschapskoffer, vervaardigd uit kunststof, met aparte inlegbak, leeg



C16 € 132,50 1 021160000
 2116VU/1 € 661,00 1 021161102
 (C16+5915VU/1)
 2116VU/3 € 1.114,00 1 021161105
 (C16+5915VU/3)

500x260x260 mm - 2,5 kg

CP17 - CP17L - 2117

Gereedschapskoffer, vervaardigd uit roestvast staal en kunststof met uitneembare inlegbak



CP17
500x200x220 mm



CP17L
575x245x265 mm

	€		
CP17	108,00	1	021170500
2117P-VU/1 (CP17+5915VU/1)	637,00	1	021171042
2117P-VU/3 (CP17+5915VU/3)	1.089,00	1	021171045
CP17L	155,00	1	021170502
2117L-VU/1 (CP17L+5915VU/1)	684,00	1	021171142
2117PL-VU/3 (CP17L+5915VU/3)	1.136,00	1	021171145

C18 - 2118

Gereedschapskist, plaatstaal



	€		
C18	50,50	1	021180001
2118VU/1 (C18+5915VU/1)	579,00	1	021181032

450x200x100 mm - 3 kg

C19 - 2119 - C19L - 2119L

Gereedschapskist uitklapbaar, driedelig, plaatstaal



C19
450x200x160 mm



C19L
550x200x160 mm

	€		
C19	67,50	1	021190001
2119VU/3 (C19+5915VU/3)	1.049,00	1	021191025
C19L	87,00	1	021190002
2119L-VU/3 (C19L+5915VU/3)	1.068,00	1	021191125

C20 - C20L - 2120

Gereedschapskist uitklapbaar, vijfdelig, plaatstaal



C20
450x200x210 mm



C20L
550x200x210 mm

	€		
C20	93,50	1	021200001
2120VU/2 (C20+5915VU/2)	571,00	1	021201061
2120VU/3 (C20+5915VU/3)	1.075,00	1	021201063
2120VU/4 (C20+5915VU/4)	1.355,00	1	021201064
2120VU/AS (C20+5915VU/AS)	1.181,00	1	021201068
C20L	106,00	1	021200002
2120L-VU/2 (C20L+5915VU/2)	584,00	1	021201161
2120L-VU/3 (C20L+5915VU/3)	1.087,00	1	021201163
2120L-VU/4 (C20L+5915VU/4)	1.370,00	1	021201164
2120L-VU/AS (C20L+5915VU/AS)	1.193,00	1	021201168

C20TSS

Gereedschapskist uitklapbaar, vijfdeilig, vervaardigd uit AISI 304 roestvast staal



C20TSS	€ 299,00	1	021203001
≡: 450x200x210 mm - 4kg			

C22B

Gereedschapskist, uit plaatstaal



C22B O
≡ 720x320x310 mm



C22BM O
≡ 850x360x350 mm



C22BL O
≡ 1010x410x400 mm

C22B-O	€ 258,00	1	022000150
C22BM-O	€ 299,00	1	022000160
C22BL-O	€ 398,00	1	022000170

C22B O: 13 kg
C22BM O: 20 kg
C22BL O: 26 kg

C22W

Gereedschapskist, plaatstaal, binnenin met hout voor optimale bescherming



C22W-O
≡ 690x300x360 mm



C22WL-O
≡ 990x300x360 mm

C22W-O	€ 290,00	1	022000269
C22WL-O	€ 384,00	1	022000299

C22W O: 15 kg
C22WL O: 28 kg

C22P

Gereedschapskist voor bouwplaatsten, vervaardigd uit plaatstaal

Ingebouwde en inklapbare handgrepen

Verhoogde steunpunten voor het werken met een vorkheftruck

Dubbele anti-diefstal sluiting (sloten niet meegeleverd)



C22PM O
≡ 915x540x430 mm



C22PL O
≡ 1220x720x615 mm

C22PM-O	€ 780,00	1	022000240
C22PL-O	€ 1.194,00	1	022000245

C22PM O: 39 kg
C22PL O: 67 kg





C99

Combo is het modulaire systeem van Beta dat bestaat uit **3 verschillende soorten stevige gereedschapskoffers** om uw werkuitrusting netjes en volkomen veilig op te bergen en te vervoeren. De gereedschapskoffers kunnen eenvoudig met een **simpele klik** aan elkaar worden gekoppeld door het functionele klikmechanisme aan de zijkant.

Het systeem, Beta Combo C99, is compatibel met de L-BOXX-standaard van Sortimo®.

C99

BETA COMBO uitgebreid modulaair systeem

De koffers kunnen eenvoudig met een simpele klik aan elkaar worden gekoppeld door het functionele klikmechanisme aan de zijkant.

Samengesteld uit:

- Ultracompacte inklapbare transportwagen met telescopische handgreep C99P (485x520x1095 mm)
- ABS koffer C99V1 (445x358x152 mm)
- ABS koffer C99V2 (445x358x254 mm)
- ABS koffer met 2 uitneembare organizers C99V3/2C (445x358x322 mm)



C99

€ 731,00 1 099000010

C99V0

COMBO ABS transport koffer, met transparante deksel

De koffers kunnen eenvoudig met een simpele klik aan elkaar worden gekoppeld door het functionele klikmechanisme aan de zijkant.

Belangrijkste kenmerken:

- Transparante deksel vervaardigd uit stevig polycarbonaat voor snelle identificatie van de inhoud
- Buiten afmetingen: 445x358x118 mm
- Max. draagcapaciteit intern: 25 kg
- Geschikt voor hangslot
- Gewicht: 2.5 kg

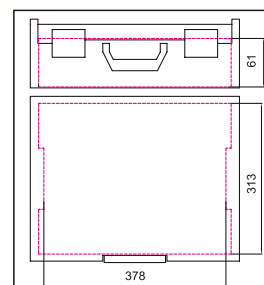

C99V0

€ 119,00 1 099000202

C99V0-P12

COMBO ABS transport koffer, met transparante deksel

De koffer kunnen eenvoudig met een simpele klik aan elkaar worden gekoppeld door het functionele klikmechanisme aan de zijkant.

Belangrijkste kenmerken:

- Transparante deksel vervaardigd uit stevig polycarbonaat voor snelle indentificatie van de inhoud
- Uitermate geschikt voor het opbergen van kleine delen, zoals schroeven, moeren, ringen, nagels en pluggen
- Geleverd met een set van 18 assortimentsbakjes:
 - 2 rode bakjes, 52x52 mm
 - 3 gele bakjes, 104x52 mm
 - 2 blauwe bakjes, 104x104 mm
 - 1 groen bakje, 104x156 mm
 - 2 oranje bakjes, 208x52 mm
 - 2 grijze bakjes, 312x71 mm, en 6 verdeelshotjes
- Buiten afmetingen: 445x358x118 mm
- Max. draagcapaciteit intern: 25 kg
- Geschikt voor hangslot
- Gewicht: 3.2 kg

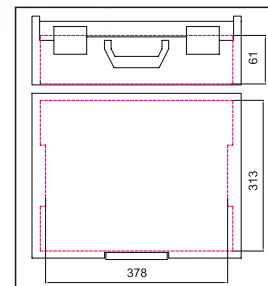

C99V0-P12

€ 169,00 1 099000200

C99P12-V0

Set van 18 bakken voor gereedschapskoffers C99V0

Set-inhoud:

- 2 rode bakjes, 52x52 mm
- 3 gele bakjes, 104x52 mm
- 2 blauwe bakjes, 104x104 mm
- 1 groene bak, 104x156 mm
- 2 oranje bakken, 208x52 mm
- 2 grijze bakkens, 312x71 mm, en 6 verstelbare tussenschotten



C99P12-V0

€ 52,50 1 099000499

C99V1

COMBO ABS transportkoffer

De koffers kunnen eenvoudig met een simpele klik aan elkaar worden gekoppeld door het functionele klikmechanisme aan de zijkant.

Belangrijkste kenmerken:

- Buiten afmetingen: 445x358x152 mm
- Max. draagcapaciteit: 25 kg
- Afsluitbaar met hangslot
- Gewicht: 2.2 kg

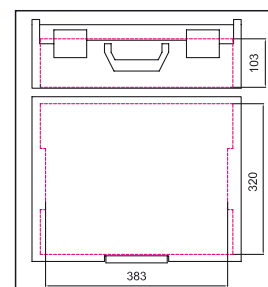

C99V1

€ 120,50 1 099000250

C99V2

COMBO ABS transportkoffer

De koffers kunnen eenvoudig met een simpele klik aan elkaar worden gekoppeld door het functionele klikmechanisme aan de zijkant.

Belangrijkste kenmerken:

- Buiten afmetingen: 445x358x254 mm
- Max. draagcapaciteit: 25 kg
- Gewicht: 2.8 kg

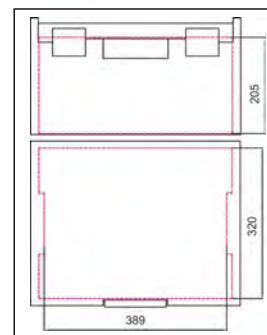

C99V2

€ 135,00 1 099000350

C99V3/2C

COMBO ABS transportkoffer met 2 uitneembare organizers

De koffers kunnen eenvoudig met een simpele klik aan elkaar worden gekoppeld door het functionele klikmechanisme aan de zijkant.

Belangrijkste kenmerken:

- Buiten afmetingen: 445x358x322 mm
- Geleverd met 2 organizers C99C-V3, leeg
- Max. draagcapaciteit: 25 kg
- Gewicht: 5.6 kg

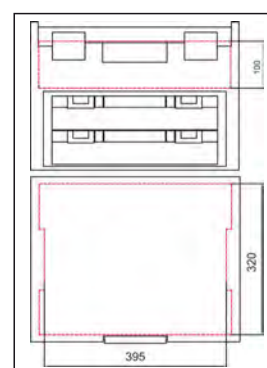

C99V3/2C

€ 256,00 1 099000450

C99C-V3

COMBO organizer koffer

Transparante deksel voor snel overzicht van de inhoud
Geïntegreerde handgreep
Buiten afmetingen: 367x316x72 mm
Gewicht: 0.9 kg

Kan worden uitgerust met:

- voorgevormde inlegbak met 7 vaks verdeling C99T-V3
- Set van 17 assortimentsdoosjes C99P-V3

C99C-V3 € 43,50 1 099000496

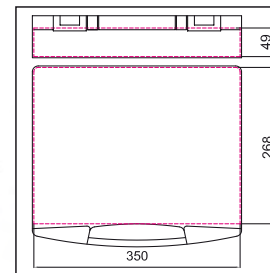

C99P

COMBO opvouwbare transportwagen

Belangrijkste kenmerken:

- Ultracompacte inklapbare transportwagen
- Telescopisch handvat
- Afmetingen geopend: 485x520x1095 mm
- Afmetingen gesloten: 485x80x810 mm
- Afmetingen inklapbare voet: 485x350 mm
- Twee massie

C99P € 220,00 1 099000101



C99PC

Afdekplaat voor transportkoffers C99V1 en C99V3/2C

Noodzakelijk in combinatie met thermogevormde inlegbakken, om te voorkomen dat de inhoud uit de compartimenten komt of verwisseld raakt tijdens transport.

C99PC 400x320x20 mm € 20,70 1 099000491



C99PP

gereedschapspaneel voor COMBO-koffers

- met 6 vakken en 11 elastische gereedschapsbanden
- compleet geleverd met haken om het paneel in de koffer te bevestigen

C99PP € 56,00 1 099000489





RSC22

gereedschapskist met 3 laden

Belangrijkste kenmerken:

- 3 laden (588x277 mm) met kogellagers:
- 1 lade, 50 mm hoog
- 2 laden, 70 mm hoog.
- centraal slot aan de voorkant.
- uittrekbare zijhandgrepen voor gebruiksgemak.

19 kg



RSC22-O



RSC22-A



RSC22-R



h	max
50 mm	25 kg
70 mm	25 kg

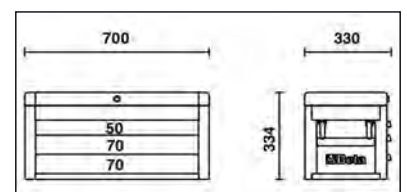
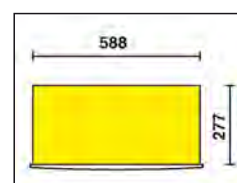

Model	RAL	€	Stk	Art. No.
RSC22-O	RAL 2011	526,00	1	022003001
RSC22-R	RAL 3000	526,00	1	022003003
RSC22-A	RAL 7016	526,00	1	022003007

RSC23

gereedschapskist
met 5 laden

Belangrijkste kenmerken:

- 5 laden (588x277 mm)
- met kogellagers:
- 2 laden, 50 mm hoog
- 3 laden, 70 mm hoog.
- Centraal slot aan de voorkant.
- uittrekbare zijhandgrepen voor bete gebruiksgemak.

📦 26 kg



RSC23-A



RSC23-R



RSC23-O



h	max
50 mm	25 kg
70 mm	25 kg

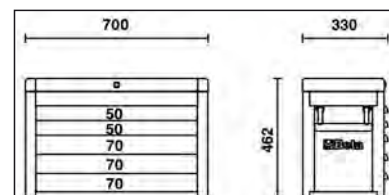
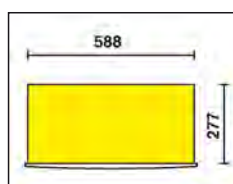

		€	📦	🏠
RSC23-O	RAL 2011	669,00	1	023003001
RSC23-R	RAL 3000	669,00	1	023003003
RSC23-A	RAL 7016	669,00	1	023003007

CD23S

Onderstel Caddy

Belangrijkste kenmerken:

- Werkblad met ABS-coating ontworpen voor gereedschapskisten C22S, C23S, C23SC, C23ST
- Afneembare handgreep, kan onder het chassis worden opgeborgen.
- Vier wielen, Ø 100 mm: 2 vaste en 2 sturende (één met rem).
- Maximaal draagvermogen: 250 kg.

📦 14 kg



		€	📦	🏠
CD23S		305,00	1	023000610

RSC23C

gereedschapskist
met 8 lades

Belangrijkste kenmerken:

- 8 laden (588x277 mm) met kogelgelagerde geleiders:
- 4 laden, 50 mm hoog
- 3 laden, 70 mm hoog
- 1 lade, 100 mm hoog.
- Centraal slot aan de voorkant.
- uittrekbare zijhandgrepen voor gebruiksgemak.

📦 28 kg



RSC23C-A



RSC23C-R



RSC23C-O



h	max
50 mm	25 kg
70 mm	25 kg

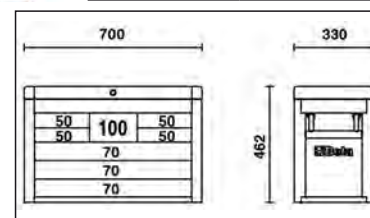
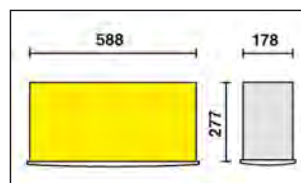

		€	📦	🏠
RSC23C-O	RAL 2011	754,00	1	023003011
RSC23C-R	RAL 3000	754,00	1	023003013
RSC23C-A	RAL 7016	754,00	1	023003017

RSC23T

gereedschapskist
met 5 laden

Belangrijkste kenmerken:

- 5 laden (588x367 mm) met kogelgelagerde geleiders:
- 5 laden, 70 mm hoog.
- centraal slot aan de voorkant.
- Kan worden uitgerust met een set van 4 zwenkwielen en 1 handgreep (2300ST/KIT)

36 kg



RSC23T-A



RSC23T-B



RSC23T-G



RSC23T-N



RSC23T-R



RSC23T-O



RSC23T-FO

 70 mm	 25 kg
--	--

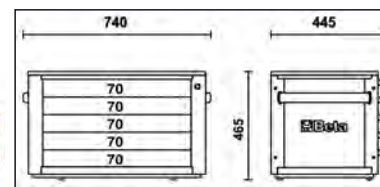
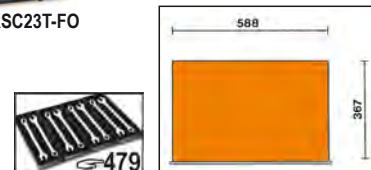

		€		
RSC23T-FO	RAL 2011	795,00	1	023003020
RSC23T-O	RAL 2011	795,00	1	023003021
RSC23T-G	RAL 9006	795,00	1	023003022
RSC23T-R	RAL 3000	795,00	1	023003023
RSC23T-B	RAL 5015	795,00	1	023003026
RSC23T-A	RAL 7016	795,00	1	023003027
RSC23T-N	RAL 9005	795,00	1	023003029

2300ST/KIT

Set met 4 wielen en duwgreep tbv C23ST

- Vier wielen, Ø 125 mm:
- 2 vaste en 2 sturende (een met rem).
- Telescoopsteel

6,5 kg

	€		
2300ST/KIT	238,50	1	023000950

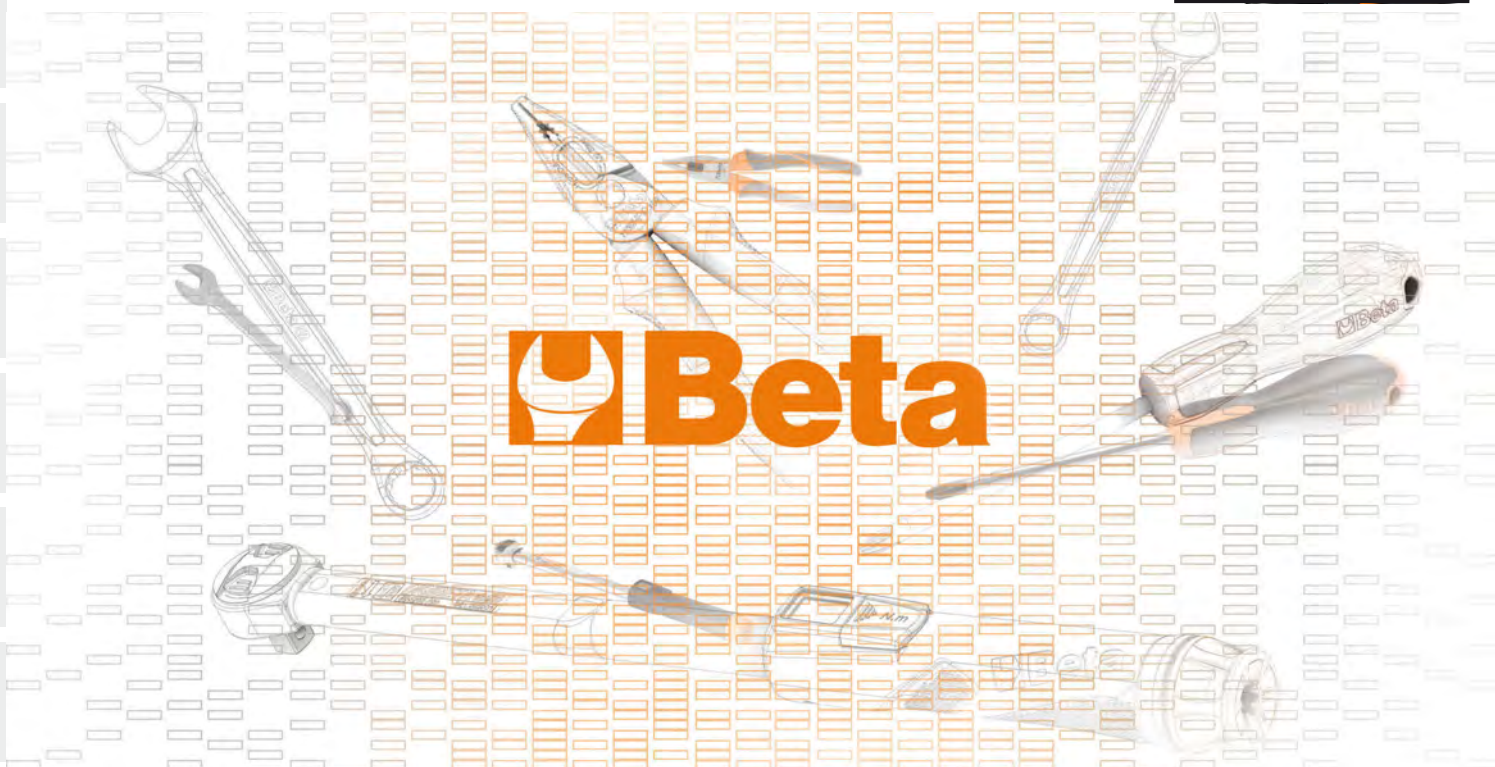

GEREEDSCHAPSWAGEN RSC24

Beta
RSC24

800 kg

NIEUW WERKBLAD

STEVIGER EN ROBUUSTER HANDIGER EN FUNCTIONELER MODERNER



- Laden met kogellager geleiding
- Ladenbodems beschermd door foam rubber matten
- Elke lade biedt plaats aan maximaal 4 EVA foam of ABS gevormde inlegbakken.
- Nieuw ABS versterkt werkblad, ontworpen om gereedschapskisten RSC22, RSC23, RSC23C en RSC23T te ondersteunen
- Multifunctioneel werkblad met opstaande randen en acht gaten voor het opbergen van schroevendraaiers
- Centraal veiligheidsslot voorzijde
- Vier wielen Ø 125 mm: 2 vaste en 2 zwenkwielen (een met rem)
- Statische laad capaciteit: 800 kg

Verkrijgbare uitvoeringen:

- RSC24/5 (5 laden)
- RSC24/6 (6 laden)
- RSC24/7 (7 laden)
- RSC24/8 (8 laden)

Verkrijgbare accessoires:



Verkrijgbare kleuren:

RSC24-		
FO	RAL 2011	RAL 2011
O	RAL 7016	RAL 2011
G	RAL 7016	RAL 9006
R	RAL 7016	RAL 3000
B	RAL 7016	RAL 5015
A	RAL 7016	RAL 7016
N	RAL 9005	RAL 9005

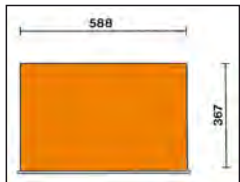
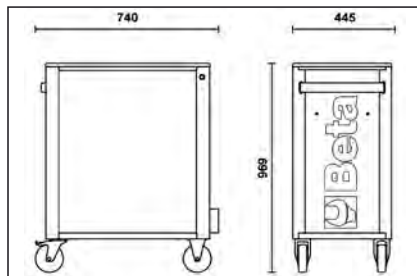

RSC24/7

Gereedschapswagen met 7 laden

Belangrijkste kenmerken:

- 7 volledig uittrekbare laden (588x367 mm), met kogellager geleiding:
- 5 laden, 70 mm hoog
- 1 laden, 140 mm hoog
- 1 lade, 210 mm hoog

63 kg

800 kg



RSC24/7-O

Beta
RSC24



RSC24/7-FO



RSC24/7-A



RSC24/7-B



RSC24/7-G



RSC24/7-N



RSC24/7-R



h		max
70 mm		25 kg
140 mm		30 kg
210 mm		30 kg

RSC24/7-FO	€	1	024004070
RSC24/7-O	1.111,00	1	024004071
RSC24/7-G	1.111,00	1	024004072
RSC24/7-R	1.111,00	1	024004073
RSC24/7-B	1.111,00	1	024004076
RSC24/7-A	1.111,00	1	024004077
RSC24/7-N	1.111,00	1	024004079

RSC24/5

Gereedschapswagen met 5 laden

Belangrijkste kenmerken:

- 5 volledig uittrekbare laden (588x367 mm), met kogellager geleiding:
- 2 laden, 70 mm hoog
- 2 laden, 140 mm hoog
- 1 lade, 280 mm hoog

60 kg

	€		
RSC24/5-FO	989,00	1	024004050
RSC24/5-O	989,00	1	024004051
RSC24/5-G	989,00	1	024004052
RSC24/5-R	989,00	1	024004053
RSC24/5-B	989,00	1	024004056
RSC24/5-A	989,00	1	024004057
RSC24/5-N	989,00	1	024004059



RSC24/5-O

Beta RSC24



h		max
70 mm		25 kg
140 mm		30 kg
280 mm		35 kg

RSC24/6

Gereedschapswagen met 6 laden

Belangrijkste kenmerken:

- 6 volledig uittrekbare laden (588x367 mm), met kogellager geleiding:
- 4 laden, 70 mm hoog
- 1 lade, 140 mm hoog
- 1 lade, 280 mm hoog

62 kg

	€		
RSC24/6-FO	1.030,00	1	024004060
RSC24/6-O	1.030,00	1	024004061
RSC24/6-G	1.030,00	1	024004062
RSC24/6-R	1.030,00	1	024004063
RSC24/6-B	1.030,00	1	024004066
RSC24/6-A	1.030,00	1	024004067
RSC24/6-N	1.030,00	1	024004069



RSC24/6-O

Beta RSC24



h		max
70 mm		25 kg
140 mm		30 kg
280 mm		35 kg

RSC24/8

Gereedschapswagen met 8 laden

Belangrijkste kenmerken:

- 8 volledig uittrekbare laden (588x367 mm), met kogellager geleiding:
- 6 laden, 70 mm hoog
- 2 laden, 140 mm hoog

66 kg

	€		
RSC24/8-FO	1.194,00	1	024004080
RSC24/8-O	1.194,00	1	024004081
RSC24/8-G	1.194,00	1	024004082
RSC24/8-R	1.194,00	1	024004083
RSC24/8-B	1.194,00	1	024004086
RSC24/8-A	1.194,00	1	024004087
RSC24/8-N	1.194,00	1	024004089



RSC24/8-O

Beta RSC24



h		max
70 mm		25 kg
140 mm		30 kg

RSC24A/6

gereedschapswagen met 6 laden,
met anti-omval systeem

Belangrijkste kenmerken:

- 6 volledig uitneembare lades (588x367 mm), met kogelgelagerde geleiders:
- 4 lades, 70 mm hoog
- 1 lade, 140 mm hoog
- 1 lade, 280 mm hoog

62 kg

	€		
RSC24A/6-O	1.148,00	1	024004161
RSC24A/6-R	1.148,00	1	024004163
RSC24A/6-A	1.148,00	1	024004167



RSC24A/6-O

Beta RSC24



RSC24A/6-A



RSC24A/6-R



h	max
70 mm	25 kg
140 mm	30 kg
280 mm	35 kg

RSC24A/7

gereedschapswagen met 7 laden,
met anti-omval beveiliging

Belangrijkste kenmerken:

- 7 volledig uitneembare lades (588x367 mm), met kogelgelagerde geleiders:
- 5 lades, 70 mm hoog
- 1 lade, 140 mm hoog
- 1 lade, 210 mm hoog.

63 kg

	€		
RSC24A/7-O	1.225,00	1	024004171
RSC24A/7-R	1.225,00	1	024004173
RSC24A/7-A	1.225,00	1	024004177



RSC24A/7-O

Beta RSC24



RSC24A/7-A



RSC24A/7-R



h	max
70 mm	25 kg
140 mm	30 kg
210 mm	30 kg

RSC24A/8

gereedschapswagen met 8 laden,
met anti-omval systeem

Belangrijkste kenmerken:

- 8 volledig uitneembare lades (588x367 mm), met kogelgelagerde geleiders:
- 6 lades, 70 mm hoog
- 2 lades, 140 mm hoog

66 kg

	€		
RSC24A/8-O	1.325,00	1	024004181
RSC24A/8-R	1.325,00	1	024004183
RSC24A/8-A	1.325,00	1	024004187



RSC24A/8-O

Beta RSC24



RSC24A/8-A



RSC24A/8-R



h	max
70 mm	25 kg
140 mm	30 kg



BREDE UITVOERING:
Elke lade biedt plaats aan maximaal 6 EVA foam of ABS gevormde inlegbakken.

ANTI-OMVAL SYSTEEM: VOORKOMT DAT MEERDERE LADEN TEGELIJKERTIJD WORDEN GEOPEND.



- Laden met kogellager geleiding
- ABS versterkt werkblad met anti-valranden, acht gaten voor het opnemen van schroevendraaiers en 6 draagtassen.
- Stevig nylon ladengreep, met geïntegreerde etikethouder
- Vier wielen Ø 125 mm: 2 vaste en 2 zwenkwielen (een met rem)
- Statische laad capaciteit: 1000 kg
- Laden bodems beschermd door foam rubber matten
- Geïntegreerde spuitbushouder aan zijkant
- Centraal veiligheidsslot aan voorzijde

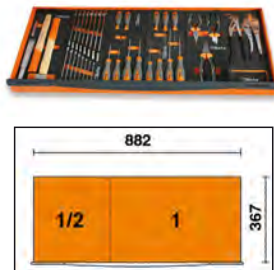
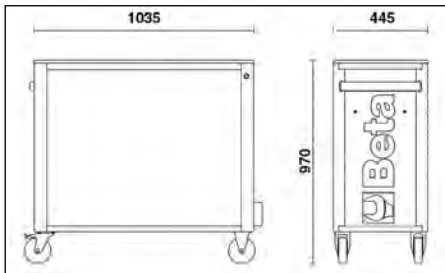

Verkrijgbare Kleuren:

O	RAL 7016	RAL 2011
R	RAL 7016	RAL 3000
A	RAL 7016	RAL 7016

Verkrijgbare accessoires:



RSC24AXL/7

Gereedschapswagen met 7 lades, met anti-omvalstelsysteem, breed model

Belangrijkste kenmerken:

- 7 volledig uitneembare lades (882x367 mm), met kogelgelagerde geleiders:
 - 5 lades, 70 mm hoog
 - 1 lade, 140 mm hoog
 - 1 lade, 210 mm hoog



Beta RSC24



h	max
70 mm	30 kg
140 mm	35 kg
210 mm	35 kg



84 kg

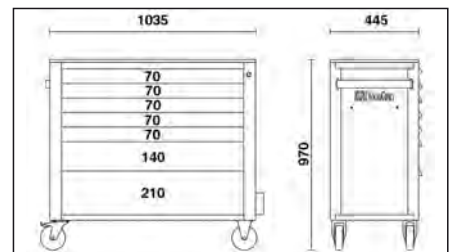
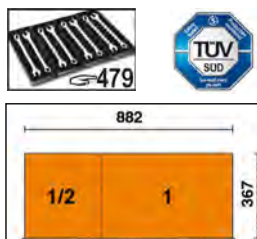

RSC24AXL/7-O	€ 1.560,00	1	024004271
RSC24AXL/7-R	€ 1.560,00	1	024004273
RSC24AXL/7-A	€ 1.560,00	1	024004277

RSC24AXL/8

gereedschapswagen met 8 laden,
met anti-omval beveiliging,
breed model

Belangrijkste kenmerken:

- 8 volledig uitneembare laden (882x367 mm), met kogelgelagerde geleiders:
- 6 laden, 70 mm hoog.
- 2 laden, 140 mm hoog.

88 kg

	€	h	l
RSC24AXL/8-O	1.670,00	1	024004281
RSC24AXL/8-R	1.670,00	1	024004283
RSC24AXL/8-A	1.670,00	1	024004287

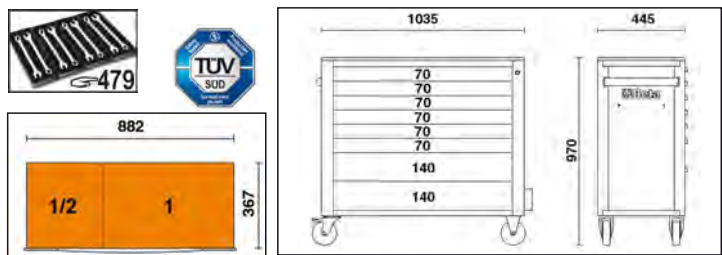

RSC24AXL/9

Gereedschapswagen met 9 laden,
met anti-omvalsysteem,
breed model

Belangrijkste kenmerken:

- 9 volledig uitneembare lades (882x367 mm), met kogelgelagerde geleiders:
- 8 laden, 70 mm hoog
- 1 lade, 140 mm hoog.

90 kg

	€	h	l
RSC24AXL/9-O	1.770,00	1	024004291
RSC24AXL/9-R	1.770,00	1	024004293
RSC24AXL/9-A	1.770,00	1	024004297

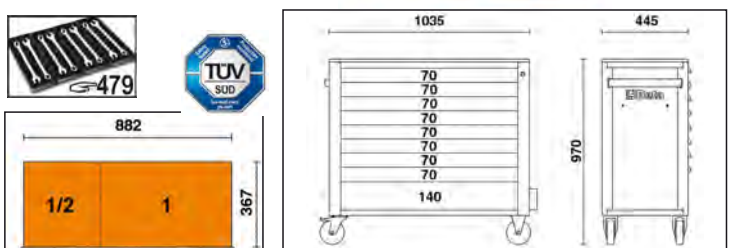

RSC24AXLP/7

Gereedschapswagen met 7 laden, met houten werkblad en anti-omval ysteem, lang model

Belangrijkste kenmerken:

- 7 volledig uitneembare lades (882x367 mm), met kogelgelagerde geleiders: 5 lades, 70 mm hoog
1 lade, 140 mm hoog
1 lade, 210 mm hoog

- Meerlaags houten werkblad met gaten voor een bankschroef 1599F/100 of 1599G/100 (apart te bestellen)
- Stevig nylon front, met ingebouwde labelhouder
- Ladebodems beschermd door scuurrubberen matten
- 4 zwenkwielen, Ø 125 mm: 2 vaste en 2 zwenkwielen (één met rem)
- Centraal veiligheidsslot aan de voorkant
- Statisch draagvermogen: 1.100 kg
- Geïntegreerde spuitbushouder (kan aan beide zijden worden aangebracht)
- Geïntegreerde papierrolhouder
- Elke lade biedt plaats aan maximaal 6 EVA foam of ABS gevormde inlegbakken

1105 kg

1100 kg

Beta RSC24



RSC24AXLP/7-O



RSC24AXLP/7-A



RSC24AXLP/7-R

h	max
70 mm	30 kg
140 mm	35 kg
210 mm	35 kg

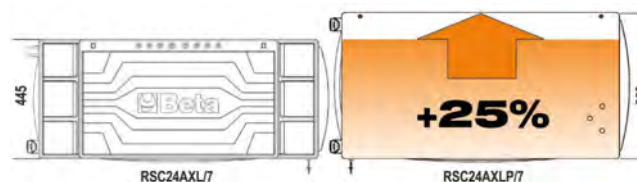

RSC24AXL7

RSC24AXLP7

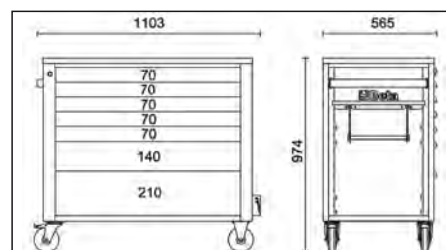
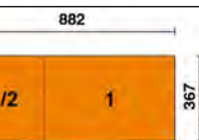

	€		
RSC24AXLP/7-O	1.690,00	1	024004571
RSC24AXLP/7-R	1.690,00	1	024004573
RSC24AXLP/7-A	1.690,00	1	024004577

2400 RSC24AXLP/CPR

Afvalbak voor gereedschapswagen RSC24AXLP/7

5 kg



	€		
2400 RSC24AXLP/CPR	68,50	1	024004993

2400 RSC24AXLP/PF

geperforeerd gereedschapspaneel met steunen, voor gereedschapswagen RSC24AXLP/7

4,5 kg



	€		
2400 RSC24AXLP/PF	125,00	1	024004992



2400 RSC24AXLP/VL

Werkbladuitbreiding voor gereedschapswagen RSC24AXLP/7

4 kg

2400 RSC24AXLP/VL

€ 52,50 1 024004995



2400 RSC24/PC

Papierrolhouder voor gereedschapswagen RSC24, RSC24A, RSC24AXL, RSC51

0,3 kg

2400 RSC24/PC-A
2400 RSC24/PC-N

€ 29,00 1 024004903
€ 29,00 1 024004904



RAL7016 2400 RSC24/PC-A
RAL9005 2400 RSC24/PC-N



2400 RSC24/PD

Documenthouder voor gereedschapswagen RSC24, RSC24A, RSC24AXL

1,2 kg

2400 RSC24/PD-A
2400 RSC24/PD-N

€ 55,00 1 024004907
€ 55,00 1 024004908



RAL7016 2400 RSC24/PD-A
RAL9005 2400 RSC24/PD-N



2400 RSC24/PF

Geperforeerde gereedschapspanelen met steunen, voor wagen RSC24, RSC24A, RSC51

2,3 kg

2400 RSC24/PF

€ 99,50 1 024004902



2400 RSC24/PF-

spruitbushouder voor gereedschapswagen RSC24, RSC24A

0,5 kg

2400 RSC24/PF-A
2400 RSC24/PF-N

€ 29,00 1 024004905
€ 29,00 1 024004906



RAL7016 2400S RSC24/PF-A
RAL9005 2400S RSC24/PF-N



2400 RSC24/PL

Houten werkblad voor wagen RSC24, RSC24A, RSC24AXL, RSC51

4,3 kg

2400 RSC24/PL

€ 123,00 1 024004901



2400 RSC24/SPC

computersteun voor gereedschapswagens RSC24, RSC24A, RSC24AXLP/7, RSC51

- Met uitneembare lade
- Kan niet worden gebruikt met model RSC24AXL

3,1 kg

2400 RSC24/SPC € 150,00 1 024004909



2400 RSC24/MP

opvouwbare plank voor artikelen RSC24, RSC24A, RSC24AXLP/7, RSC51

- Te gebruiken als extra werkblad
- Afmetingen werkblad: 390x440 mm, beschermd door een anti-olie en anti-benzine rubberen mat
- Draagvermogen: 20 kg

3,4 kg

2400 RSC24/MP € 88,00 1 024004900



2499PF

Flessenhouder

- Toepasbaar op gereedschapswagen C38, C38A

2,5 kg

2499PF-O € 80,00 1 024990210
2499PF-G € 80,00 1 024990219
2499PF-R € 80,00 1 024990230

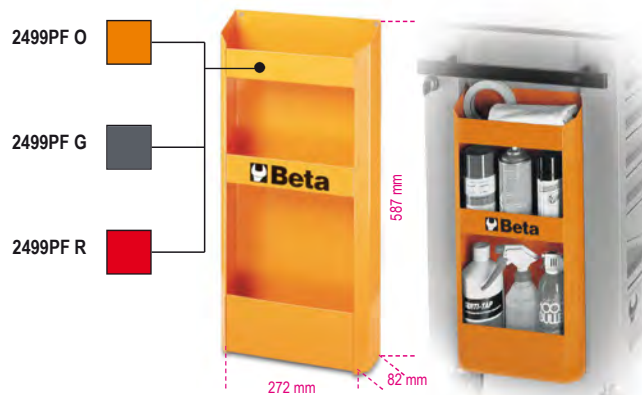

2499PF/M

Universele magnetische spuitbushouder

2,2 kg

2499PF/M € 77,00 1 024990050



2499PC

Papierrolhouder

Past op Tank C25 en C38.

2,2 kg

2499PC € 97,00 1 024990090



RSC24L/7

Gereedschapswagen verrijdbare werkbank met 7 laden en legborden

Belangrijkste kenmerken:

- 7 laden (588x367 mm) met kogellagers:
- 5 laden, 70 mm hoog
- 1 lade, 140 mm hoog
- 1 lade, 210 mm hoog.
- Ladenbodems beschermd door schuimrubberen matten.
- 4 wielen, Ø 125 mm:
- 2 vast en 2 sturend met remmen.
- centraal slot aan de voorkant.
- Statisch draagvermogen: 1.100 kg.
- Meerlaags houten werkblad met gaten voor bankschroef (1599F/100 - 1599GI/100, apart te bestellen).
- Zijvak met verticaal verstelbare plank.
- Ingebouwde papierrolhouder.
- Dubbele spuitbushouder aan de achterkant
- Geïntegreerde spuitbushouder aan de zijkant

80 kg

		€	1	024004371
RSC24L/7-O	RAL 2011	1.685,00	1	024004371
RSC24L/7-R	RAL 3000	1.685,00	1	024004373
RSC24L/7-A	RAL 7016	1.685,00	1	024004377

Beta R5 C24

1100 kg



RSC24L/7-A



RSC24L/7-R



RSC24L/7-O

h	max
70 mm	25 kg
140 mm	30 kg
210 mm	30 kg

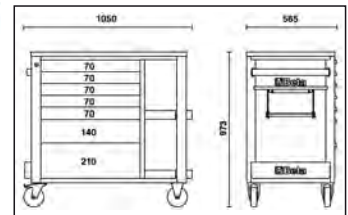
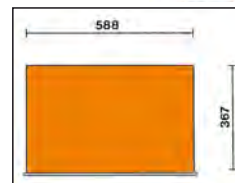

RSC24L-CAB

verrijdbare werkbank met 7 laden en afsluitbare kast

Belangrijkste kenmerken:

- 7 lades (588x367 mm) met kogellagers:
- 5 lades, 70 mm hoog
- 1 lade, 140 mm hoog
- 1 lade, 210 mm hoog.
- Ladebodems beschermd door schuimrubberen matten.
- 4 wielen, Ø 125 mm:
- 2 vast en 2 sturend met remmen.
- Gecentraliseerd slot aan de voorkant.
- Zijgereedschapskast met afsluitbare deur en verticaal verstelbare binnenplank.
- Statisch draagvermogen: 1.100 kg.
- Meerlaags houten werkblad met gaten voor een ondeugd (1599F/100, apart te bestellen).
- Ingebouwde papierrolhouder.
- Dubbele flessenhouder aan de achterkant.
- Geïntegreerde spuitbushouder aan de zijkant

82 kg

		€	1	024004471
RSC24L-CAB/O	RAL 2011	1.745,00	1	024004471
RSC24L-CAB/R	RAL 3000	1.745,00	1	024004473
RSC24L-CAB/A	RAL 7016	1.745,00	1	024004477

Beta R5 C24

1100 kg



RSC24L-CAB/A



RSC24L-CAB/R



RSC24L-CAB/O

h	max
70 mm	25 kg
140 mm	30 kg
210 mm	30 kg

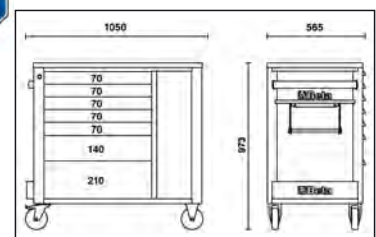

C04TSS-7

Gereedschapswagen met zeven laden, volledig vervaardigd uit roestvast staal, **Streep vrij wielen**

Belangrijkste kenmerken:

- Zeven laden (570 x 410 mm) met kogellager geleiding;
- 6 laden, 83 mm hoog;
- 1 lade, 170 mm hoog;
- 4 wielen Ø 125 mm 2 vaste en 2 zwenkwielen (twee met rem);
- Centraal veiligheidsslot voorzijde;
- Gehele constructie vervaardigd uit roestvast staal
- Wielen, geleiders, lagers en laden zijn vervaardigd uit roestvast staal
- Laden handgrepen zijn vervaardigd uit aluminium



700 kg



63 kg

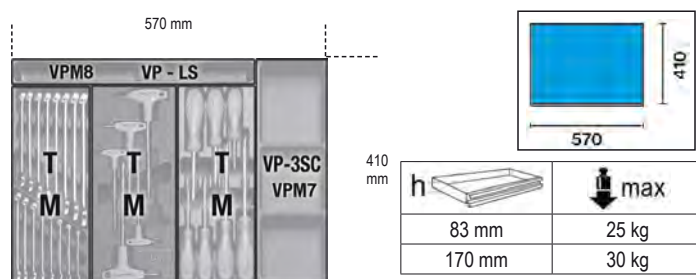

C04TSS/7 € 2.900,00 1 024003077 303

C25

Gereedschapswagen Tank met zijbak

Voornaamste kenmerken:

- Opklapbaar deksel.
- 1 schuiflade.
- Opbergbak gereedschappen is met rubbermatten bekleed.
- Bodems van de werkbladen door middel van rubbermatten tegen olie en benzine beschermd.
- Vier wielen ø 100 mm: 2 vaste en 2 zwenkwielen (een met rem).
- Veiligheidsslot.
- Lege kunststof inleg voor voor 1/2" dopsleutels en toebehoren (024990104).
- U kunt hierop de papierrolhouder 2499PC bevestigen.

31,5 kg

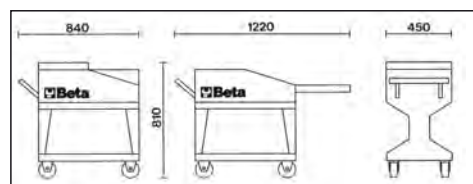

C25 € 761,00 1 025000001

C27S

Inklapbare gereedschapswagen voor mobiele werkzaamheden

Inklapbare gereedschapswagen, met opvouwbare steunen voor eenvoudig transport.

2 laden, 588x277 mm, met kogellagergeleiding aan weerszijden te openen.

Groot opbergvak in bodemconstructie, 588x277x220 mm.

Plaatstalen frame.

2 vaste wielen, Ø 160 mm, en 2 zwenkwielen, Ø 100 mm met rem.

Thermoplastisch werkblad met 6 geïntegreerde houders.

Centraal slot.

Is geschikt voor de vakindeling en foam inlegbakken MC serie

20 kg



C27S-O



C27S-G



C27S-R



h		max	
	70 mm		20 kg

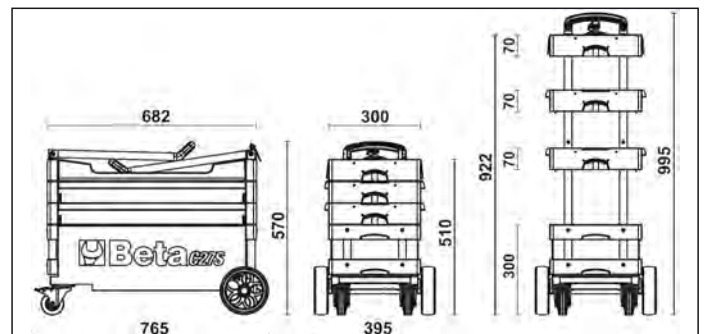
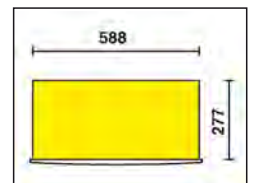

		€	📦	🚚
C27S-O	RAL 2011	811,00	1	027000201
C27S-G	RAL 7016	811,00	1	027000202
C27S-R	RAL 3000	811,00	1	027000203

RSC28

SuperTank verrijdbare werkbank met houten werkblad en 10 laden

Belangrijkste kenmerken:

- 10 laden (588x367 mm) met kogelgelagerde geleiders.
- Snel, veilig systeem voor het openen en sluiten van lades, met front van nylon en glasvezel.
- 5 zijladen:
 - 4 laden, 70 mm hoog
 - 1 lade, 210 mm hoog.
- 5 laden aan de voorkant:
 - 4 laden, 70 mm hoog
 - 1 lade, 210 mm hoog.
- Ladebodems beschermd door schuimrubberen matten.
- 4 grote wielen, Ø 150 mm:
 - 2 vast en 2 sturend met remmen.
- 2 gecentraliseerde veiligheidssloten.
- 3 gereedschapsladen aan de voorkant.
- Meerlaags houten werkblad met gaten voor bankschroef (1599F/150 - 1599GI/150, apart te bestellen).
- Ingebouwd gereedschapsvak.
- Zijvak met opklapbare deur met slot.
- Ingebouwde spuitbushouders.
- 135 mm hoog opbergvak met kunststof beklede bodem.
- Statisch draagvermogen: 1.200 kg

 **1200 kg**



RSC28-O

 **130 kg**



RSC28-A



RSC28-R



h	max
70 mm	25 kg
210 mm	30 kg

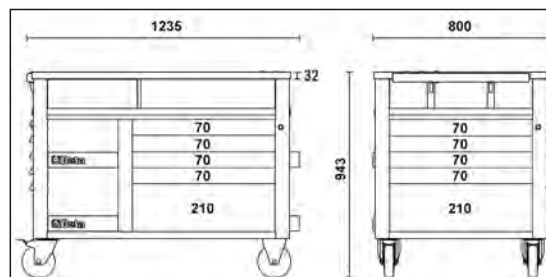
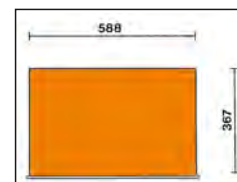

	€		
RSC28-O	3.000,00	1	028003001
RSC28-R	3.000,00	1	028003003
RSC28-A	3.000,00	1	028003007

C30M

MaxiTank verrijdbare werkbank

Belangrijkste kenmerken:

- 5 voorladen met kogelgelagerde geleiders: 3 laden (367x610 mm), 90 mm hoog
1 lade (588x610 mm), 90 mm hoog
1 lade (588x610 mm), 180 mm hoog.
- Snelopeningssysteem met aluminium front.
- Ladenbodems beschermd door schuimrubberen matten.
- Kan worden voorzien van inlays.
- Eén hydraulische unit, ontworpen om het voorste deel moeiteloos op te tillen, waardoor transport zeer eenvoudig wordt.
- 4 wielen met hoge capaciteit: 2 stuurinrichting, voor, Ø 150 mm
2 vast, achter, Ø 170 mm.
- Oliebestendig, met rubber bekleed werkblad, 1300x800 mm, met afvoergat voor vloeistofopvang in een kleine tank.
- Opbergvak, 720x250x1300 mm, met PVC-gecoat werkblad en schuifpanelen aan de voorzijde.
- centraal slot voor laden en panelen.
- 3 ingebouwde spuitbushouders aan de zijkant.
- Ingebouwde papierrolhouder
- Statisch draagvermogen: 1.800 kg.
- Geschikt voor een meerlaags houten werkblad (3000M/PLM), apart te bestellen
- Geschikt voor bankschroef 1599F/150 (apart te bestellen).



1800
kg



 200 kg

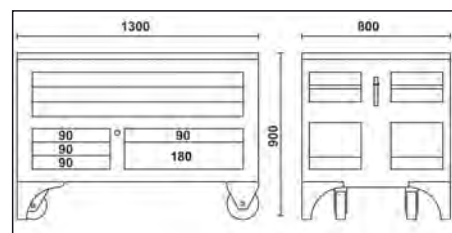
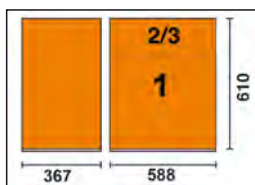

h	max
90 mm	30 kg
180 mm	35 kg



C30M

€ 5.000,00  1  030000300

3000M/PLM

houten werkblad voor C30M,
met gaten voor een bankschroef (1599F/150)

 10 kg



 1240x740x26 mm

3000M/PLM

€ 523,00  1  030000350

FUNCTIONEEL EN STEVIG



- Uittrekbare laden
- Centraal veiligheidsslot voorzijde
- Geschikt voor het ondersteunen van een werkblad en ladenverdeling, apart te bestellen
- Statische laad capaciteit: 1200 kg

Beschikbare uitvoeringen:

- **C35/6GM** (6 laden)
- **C35/7GM** (7 laden)
- **C35/8GM** (8 laden)
- **C35/9GM** (9 laden)

Verkrijgbare accessoires:

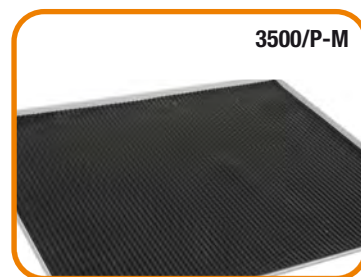

C35/6GM

Industrieel ladenblok met 6 laden

Belangrijkste kenmerken:

- 6 uittrekbare laden (600x447 mm):
 - 2 laden, 75 mm hoog
 - 1 lade, 100 mm hoog
 - 1 lade, 150 mm hoog
 - 1 lade, 200 mm hoog
 - 1 lade, 300 mm hoog
- Gecentraliseerd veiligheidsslot aan de voorzijde.
- Biedt plaats aan een werkblad en ladeschotten, apart te bestellen

75 kg

1200 kg



h	↓ max
75 mm	70 kg
100 mm	70 kg
150 mm	70 kg
200 mm	70 kg
300 mm	70 kg

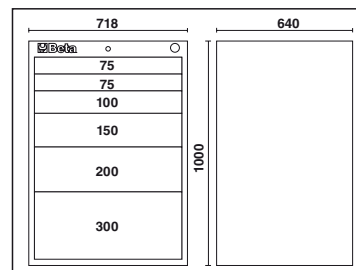
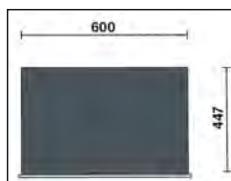

C35/6GM € 2.250,00 1 035000162

C35/7GM

Industrieel ladenblok met 7 laden

Belangrijkste kenmerken:

- 7 uittrekbare lades (600x447 mm):
 - 2 laden, 75 mm hoog
 - 1 lade, 100 mm hoog
 - 3 laden, 150 mm hoog
 - 1 lade, 200 mm hoog
- Gecentraliseerd veiligheidsslot aan de voorzijde.
- Optioneel werkblad en vakverdelers, apart te bestellen

82 kg

C35/7GM

€ 2.295,00 1 035000172

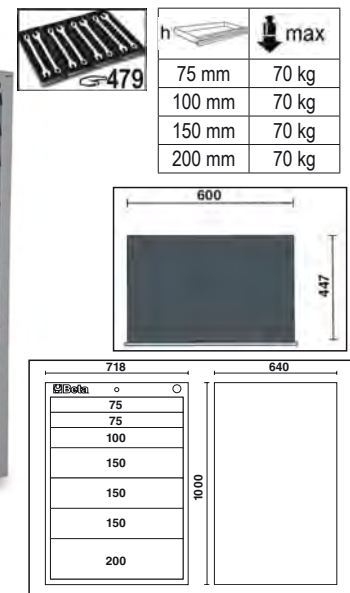

C35/8GM

Industrieel ladenblok met 8 laden

Belangrijkste kenmerken:

- 8 uittrekbare lades (600x447 mm):
 - 4 laden, 75 mm hoog
 - 1 lade, 100 mm hoog
 - 2 laden, 150 mm hoog
 - 1 lade, 200 mm hoog
- Gecentraliseerd veiligheidsslot aan de voorzijde.
- Biedt plaats aan een werkblad en ladeschotten, apart te bestellen

86 kg

C35/8GM

€ 2.350,00 1 035000182

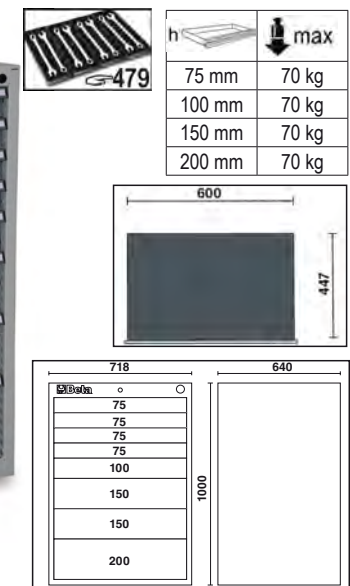

C35/9GM

Industrieel ladenblok met 9 laden

Belangrijkste kenmerken:

- 9 uittrekbare lades (600x447 mm):
 - 6 laden, 75 mm hoog
 - 3 laden, 150 mm hoog
- Gecentraliseerd veiligheidsslot aan de voorzijde.
- Biedt plaats aan een werkblad en ladeschotten, apart te bestellen

91 kg

C35/9GM

€ 2.450,00 1 035000192

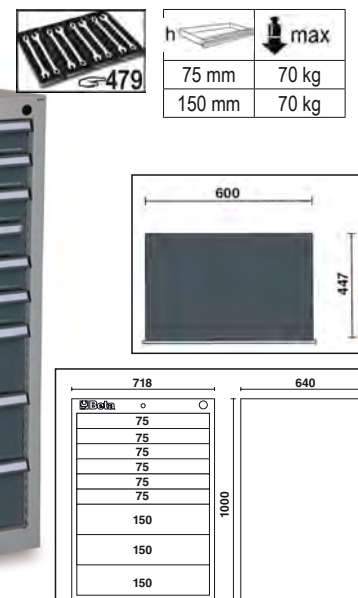

3500/P-M

werkblad met rand voor gereedschapskist C35

3500/P-M

700x600 mm

€ 424,00 1 035000505



ZACHTE BUMPERS

- Laden met kogellager geleiding
- Stevig multifunctioneel werkblad
- Ladengreep vervaardigd uit aluminium, snel te ontgrendelen over de gehele lengte van de lade
- Uitsparingen en gaten voor het opbergen van schroevendraaiers
- Vier wielen Ø 125 mm: 2 vaste en 2 zwenkwielen (een met rem)
- Statische laad capaciteit: 1000 kg
- Hoekbumpers over de gehele hoogte van de wagen, om schade aan voertuigen in de werkplaats te voorkomen.
- Ladenbodems beschermd door foam rubber matten
- Centraal veiligheidsslot aan voorzijde
- Geïntegreerde spuitbus - en papierrolhouder, verstelbaar op verschillende hoogtes

Verkrijgbare uitvoeringen:

- C37/6 (6 laden)
- C37/7 (7 laden)
- C37/8 (8 laden)
- C37A/7 (7 laden met anti omvalsystem)

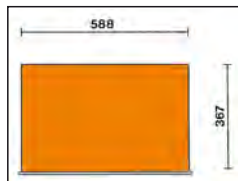

Verkrijgbare kleuren:

O	RAL 2011
G	RAL 7016
R	RAL 3000

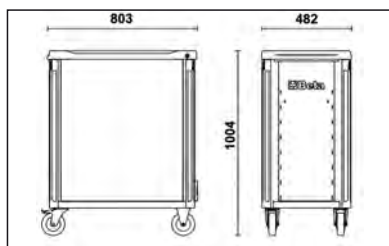

Verkrijgbare accessoires:

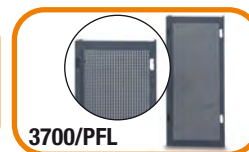

C37/7

Gereedschapswagen met 7 laden

Belangrijkste kenmerken:

- 7 laden (588x367 mm) met kogellager geleiding:
- 5 laden 75 mm hoog
- 1 lade 150 mm hoog
- 1 lade 225 mm hoog
- Robuuste multifunctioneel werkblad.
- Uitsparingen en gaten voor het opbergen van schroevendraaiers.
- Handige "V"-vormige uitsparing voor het fixeren van pijpen en andere delen.
- Ladengreep vervaardigd uit aluminium, met ontsluitings mechanisme over de gehele lengte van de lade.
- Beschermende hoekbumpers over de gehele hoogte van de wagen om schade aan voertuigen in de werkplaats te voorkomen.
- Ladenbodems beschermd door zachte rubber matten.
- Vier wielen Ø 125 mm:
- 2 vaste en 2 zwenkwielen (een met rem).
- Centraal veiligheidsslot aan voorzijde.
- Statische laad capaciteit: 1000 kg.
- Geïntegreerde spuitbus en papierrolhouder, verstelbaar op verschillende hoogtes.

71 kg



	€		
C37/7-O	1.345,00	1	037000071
C37/7-G	1.345,00	1	037000072
C37/7-R	1.345,00	1	037000073

h	max
75 mm	30 kg
150 mm	35 kg
225 mm	35 kg

C37/6

Gereedschapswagen
met 6 laden

Belangrijkste kenmerken:

- 6 laden (588x367 mm) met kogellager geleiding:
- 4 laden 75 mm hoog
- 1 lade 150 mm hoog
- 1 lade 305 mm hoog

1000
kg



C37/6-O

69 kg

	€	1	037000061
C37/6-O	1.290,00	1	037000061
C37/6-G	1.290,00	1	037000062
C37/6-R	1.290,00	1	037000063



C37/6-G



C37/6-R



h	max
75 mm	30 kg
150 mm	35 kg
305 mm	40 kg



C37/8

Gereedschapswagen
met 8 laden

Belangrijkste kenmerken:

- 8 laden (588x367 mm) met kogellager geleiding:
- 6 laden 75 mm hoog
- 2 lade 150 mm hoog

1000
kg



C37/8-O

73 kg

	€	1	037000081
C37/8-O	1.385,00	1	037000081
C37/8-G	1.385,00	1	037000082
C37/8-R	1.385,00	1	037000083



C37/8-G



C37/8-R



h	max
75 mm	30 kg
150 mm	35 kg



C37A/7

Gereedschapswagen
met 7 laden, met anti-omval beveiliging

Belangrijkste kenmerken:

- 7 laden (588x367 mm), met kogellagergeleiding:
- 5 laden 75 mm hoog
- 1 lade 150 mm hoog
- 1 lade 225 mm hoog

1000
kg



C37A/7-O

71 kg

	€	1	037000271
C37A/7-O	1.380,00	1	037000271
C37A/7-G	1.380,00	1	037000272
C37A/7-R	1.380,00	1	037000273



C37A/7-G



C37A/7-R



h	max
75 mm	30 kg
150 mm	35 kg
225 mm	35 kg



3700/PLA

Roestvast stalen werkblad voor gereedschapswagen artikel C37

2,8 kg

3700/PLA € 85,00 1 037000100



3700/PLL

houten werkblad voor gereedschapswagen C27

Geschikt voor een bankschroef (1599P/100, apart te bestellen)

3,9 kg

3700/PLL € 102,50 1 037000101



672x396x28 mm

3700/PF

Geperforeerd wandpaneel met haken voor gereedschapswagen artikel C37

3,2 kg

3700/PF € 82,50 1 037000102



626
650



3700/PFL

Geperforeerd zijpaneel voor gereedschapswagen C37

1,9 kg

3700/PFL € 46,00 1 037000104



754
321



3700/PC

Laptohouder voor gereedschapswagen C37

3,1 kg

3700/PC € 112,50 1 037000103

303
399
418



C38

Gereedschapswagen
met elf laden

Voornaamste kenmerken:

- 11 laden met ladengeleiding op kogels:
- 1 lade 937x410x122 mm
- 3 lades 570x410x74 mm
- 2 lades 570x410x153 mm
- 3 lades 313x410x74 mm
- 2 lades 313x410x153 mm.
- Ladenbodems worden beschermd door rubber inlegmat.
- 1200 kg Laadvermogen.
- 4 wielen Ø 125 mm,
- 2 vaste en 2 zwenkwielen (beide met rem).
- Centraal veiligheidsslot.
- Bovenblad beschermd door rubber mat.
- Optioneel leverbaar de spuitbushouder 2499PF en papierrol houder 2499PC.



114 kg



h	max
74 mm	25 kg
153 mm	30 kg

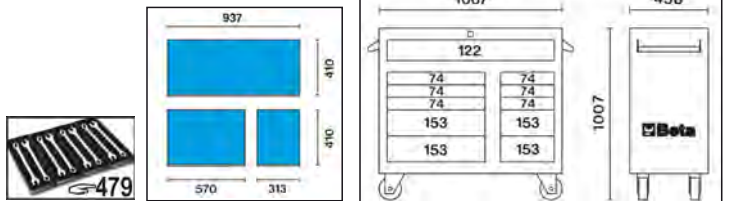

	€		
C38-O	1.995,00	1	038000001
C38-G	1.995,00	1	038000003
C38-R	1.995,00	1	038000002

C38L

Zijkast met 7 laden

Belangrijkste kenmerken:

- 7 laden (410x313 mm), met kogelgelagerde geleiders:
- 5 lades, 74 mm hoog 2 lades, 153 mm hoog.
- Ladenbodems beschermd door schuimrubberen matten.
- veiligheidsslot aan de voorkant.
- Antislip aluminium werkblad.
- Kan aan beide zijden van gereedschapswagen C38 worden gehangen

45 kg

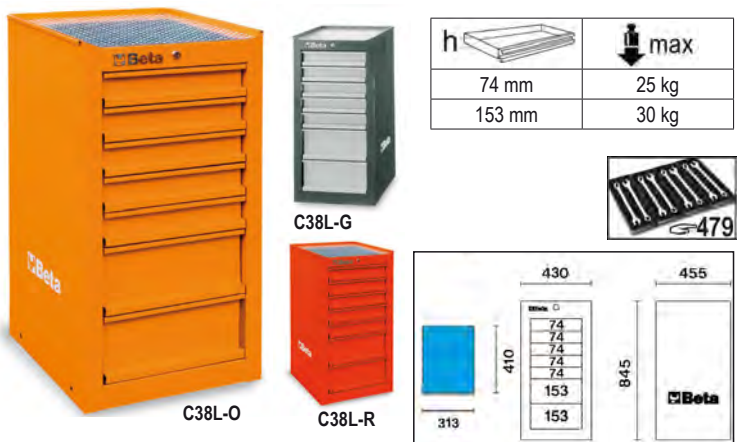

h	max
74 mm	25 kg
153 mm	30 kg

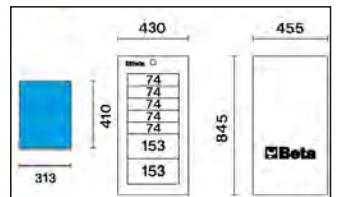

	€		
C38L-O	1.051,00	1	038000081
C38L-G	1.051,00	1	038000083
C38L-R	1.051,00	1	038000082

C38LA

Zijhangkast met legplank

Belangrijkste kenmerken:

- Voorvergrendeling.
- Verticaal verstelbare binnenplank.
- Documentenvak aan de binnenkant van de deur.
- Antislip aluminium werkblad.
- Kan aan beide zijden van de verrijdbare rolcabine C38 worden gehangen

18 kg

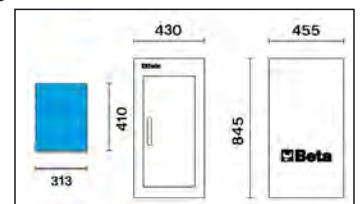

	€		
C38LA O	399,00	1	038000071
C38LA G	399,00	1	038000073
C38LA R	399,00	1	038000072

C38C

Gereedschapswagen met 33 laden, bestaande uit:

- gereedschapswagen C38
- 2 zijkasten C38L
- 1 opzetkist C38T

268 kg



C38C-O



C38C-G



C38C-R



h	max
74 mm	25 kg
153 mm	30 kg

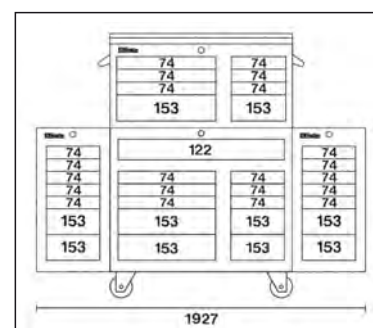
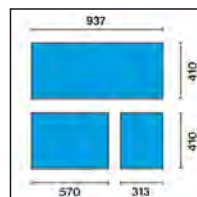

	€		
C38C-O	5.470,00	1	038000201
C38C-G	5.470,00	1	038000203
C38C-R	5.470,00	1	038000202

C38T

Opzetkist met 8 laden

Belangrijkste kenmerken:

- 8 laden met kogelgelagerde geleiders:
- 3 laden 570x410x74 mm
- 1 lade 570x410x153 mm
- 3 laden 313x410x74 mm
- 1 lade 313x410x153 mm.
- Gereedschapscompartiment.
- Ladenbodems beschermd door schuimrubberen matten.
- Veiligheidsslot aan de voorkant.
- Kan op werkblad of gereedschapswagen C38 worden geplaatst.

64 kg



C38T-O



C38T-G



C38T-R

h	max
74 mm	25 kg
153 mm	30 kg

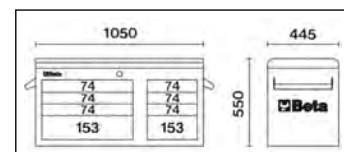
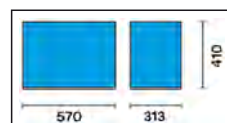

	€		
C38T-O	1.370,00	1	038000091
C38T-G	1.370,00	1	038000093
C38T-R	1.370,00	1	038000092

GEREEDSCHAPSWAGEN C39

FRAME EN VOORZIJD E LADEN VERVAARDIGD UIT EEN ALUMINIUM LEGERING + STEVIGHEID + GEWICHTSBESPARING

- Laden met kogellager geleiding
- Thermoplastisch werkblad, geschikt voor het ondersteunen van de gereedschapskist C39T
- Ladengreep vervaardigd uit aluminium, snel te ontgrendelen over de gehele lengte van de lade
- Vier wielen Ø 125 mm: 2 vaste en 2 zwenkwielen (een met rem)
- Statische laad capaciteit: 1200 kg
- Ladenbodems beschermd door foam rubber matten
- Uitsparingen en gaten voor het opbergen van schroevendraaiers
- Centraal veiligheidsslot aan voorzijde
- Geïntegreerde spuitbus houders aan de zij- en achterkant
- Geïntegreerde papierrolhouder

Verkrijgbare uitvoeringen:

- C39/6 (6 laden)
- C39/7 (7 laden)
- C39/8 (8 laden)

Verkrijgbare kleuren:

	
O	RAL 2011
G	RAL 7016
R	RAL 3000

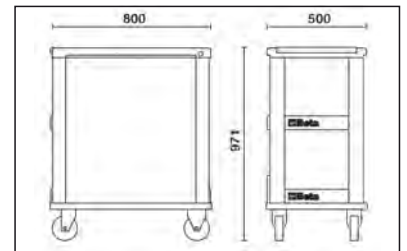
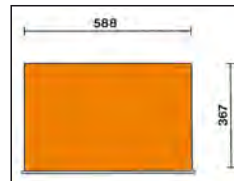

C39/7

Gereedschapswagen met zeven laden

Belangrijkste kenmerken:

- Zeven laden (588x367 mm) met kogelgelagerde geleiding:
 - 5 laden, 70 mm hoog
 - 1 lade, 140 mm hoog
 - 1 lade, 210 mm hoog.
- Ladenbodems beschermd door rubber mat.
- vier wielen 125 mm in Ø:
 - 2 vaste en 2 zwenkwielen (1 met rem).
- centraal veiligheidsslot aan voorzijde.
- Het ontsluiten van de lade over de gehele lengte van de lade.
- Statisch laadvermogen: 1200 kg.
- Thermoplastische werkblad.
- Geïntegreerde spuitbushouders aan zij en achterkant.
- Geïntegreerde papierrolhouder.
- Frame en laden voorkant vervaardigd uit aluminium.

61 kg



C39-7/G



C39-7/R

C39-7/O

	€	🔧	📄
C39-7/O	2.070,00	1	039000001
C39-7/G	2.070,00	1	039000002
C39-7/R	2.070,00	1	039000003

h	max
70 mm	30 kg
140 mm	35 kg
210 mm	35 kg



C39/6

Gereedschapwagen met zes laden

Belangrijkste kenmerken:

- Zes laden (588x367 mm) kogelgelagerde geleiding:
- 4 laden, 70 mm hoog
- 1 lade, 140 mm hoog
- 1 lade, 280 mm hoog

1200
kg



C39-6/O



C39-6/G



C39-6/R



h	max
70 mm	30 kg
140 mm	35 kg
280 mm	40 kg



59 kg

	€		
C39-6/O	1.970,00	1	039000031
C39-6/G	1.970,00	1	039000032
C39-6/R	1.970,00	1	039000033

C39/8

Gereedschapwagen met acht laden

Belangrijkste kenmerken:

- Acht laden (588x367 mm) kogelgelagerde geleiding:
- 6 laden, 70 mm hoog
- 2 laden, 140 mm hoog

1200
kg



C39-8/O



C39-8/G



C39-8/R



h	max
70 mm	30 kg
140 mm	35 kg



64 kg

	€		
C39-8/O	2.185,00	1	039000041
C39-8/G	2.185,00	1	039000042
C39-8/R	2.185,00	1	039000043

C39T

Gereedschapskist met vier laden

Belangrijkste kenmerken:

- Vier laden (588x367 mm) op kogelgelagerde geleiding:
- 4 laden, 70 mm hoog
- Centraal veiligheidsslot.
- Frame en ladengreep vervaardigd uit aluminium.



C39T-O



C39T-R



C39T-G



29 kg

h	max
70 mm	30 kg

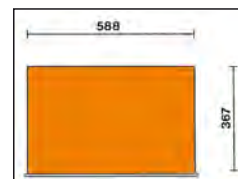
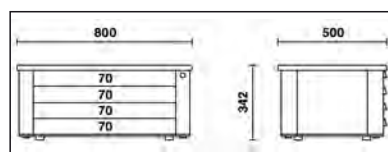

29 kg

	€		
C39T-O	1.350,00	1	039000101
C39T-G	1.350,00	1	039000102
C39T-R	1.350,00	1	039000103

2400-COVER RSC24

Nylon hoes voor mobiele rolcabines C24S/SA - C39

2400-COVER RSC24 € 30,00 1 024000910



2400-COVER RSC24AXL

Nylon hoes voor gereedschapswagens C24SA-XL, C24SL, C24SL-CAB

2400-COVER RSC24AXL € 40,00 1 024000930



3700-COVER C37

Nylon beschermhoes voor gereedschapswagens artikelen C37

3700-COVER C37 € 39,50 1 037000930



Beta

C39SM

Speciale gereedschapswagen, type Racing SM

Specificaties

- Multiplex houten werkblad
- 4 wielen, Ø 125 mm
- 2 vaste en 2 zwenkwielen (een met rem), met beschermingspaneel
- Statische laad capaciteit: 1200 kg

7-laden module

588x367 mm, met kogellager geleiding:

- 6 laden, 70 mm hoog
- 1 lade, 240 mm hoog
- Ladenbodems beschermd door rubber inlegmat
- Centraal veiligheidslot
- Het openen van de laden uit het vergrendeling is mogelijk over de gehele lengte van de lade.
- Ladengreep uit aluminium

Service module

- Geïntegreerde afvalbak
- Papierrolhouder vak
- 1 grote lade (420x305x270 mm)

125 kg

		€		
C39SM-O	RAL 2011	3.310,00	1	039390001
C39SM-G	RAL 7016	3.310,00	1	039390002
C39SM-R	RAL 3000	3.310,00	1	039390003



C39SM-O



h	max
70 mm	30 kg
240 mm	40 kg

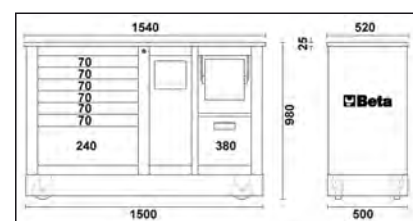
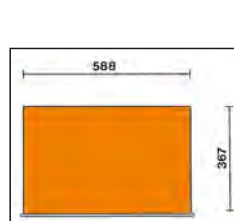

C39MD

Speciale gereedschapswagen, type Racing MD

Specificaties

- Multiplex houten werkblad
- 4 wielen, Ø 125 mm
- 2 vaste en 2 zwenkwielen (een met rem), met beschermingspaneel
- Statische laad capaciteit: 1200 kg

7-laden module

588x367 mm, met kogellager geleiding:

- 6 laden, 70 mm hoog
- 1 lade, 240 mm hoog
- Ladenbodems beschermd door rubber inlegmat
- Centraal veiligheidslot
- Het openen van de lade uit de vergrendeling is mogelijk over de gehele lengte van de lade
- Ladengreep uit aluminium

2-laden module

588x367x270 mm en 588x367x380 mm, met kogellager geleiding

- Ladenbodems beschermd door rubber inlegmat
- Centraal veiligheidslot
- Het openen van de laden uit de vergrendeling is mogelijk over de gehele lengte van de lade.
- Ladengreep uit aluminium

123 kg

		€		
C39MD-O	RAL 2011	3.430,00	1	039390101
C39MD-G	RAL 7016	3.430,00	1	039390102
C39MD-R	RAL 3000	3.430,00	1	039390103

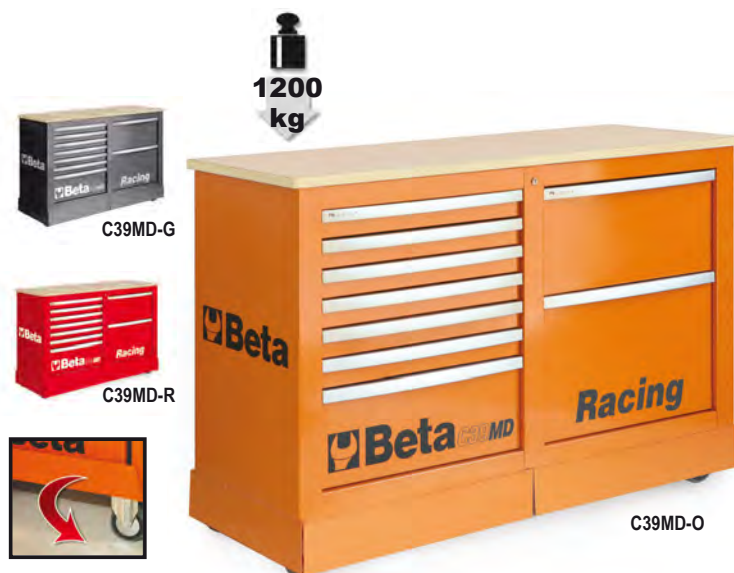

C39MD-G

C39MD-R

C39MD-O



h	max
70 mm	30 kg
240 mm	40 kg

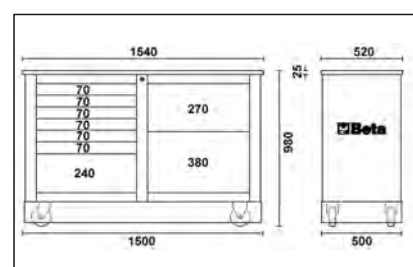
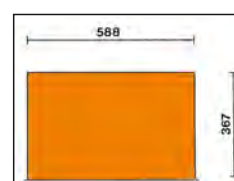

C41S

Trolley twee-delig

Belangrijkste kenmerken:

- Plaatstalen frame met kunststof bovenzijde staan synoniem voor stevigheid en licht van gewicht.
- 2 afneembare modules:
 - 1 bovenste gereedschapskoffer,
 - 1 module met twee laden, 95 mm en 295 mm hoog.
- Extra grote wielen (160 mm), binnenin de behuizing voor vereenvoudiging van transport - bijv. op trappen
- Centraal veiligheidsslot aan zijkant voor het sluiten van laden on derste module.
- Laden met kogellagergeleiding en dubbele klemhaak.
- Telescopische aluminium handgreep.
- Compartiment voor kleine delen in bovenste module.
- Onderste lade is voorzien van dubbele laden geleidingop kogels

Aanbevolen assortimenten: 5940/SBK and 5915VU/5

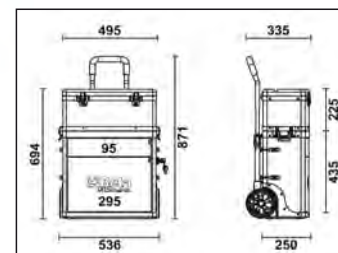
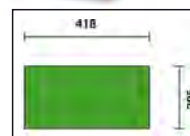

16 kg

C41S	€ 551,00	1	041000001
------	----------	---	-----------

C41H

Trolley twee-delig

Belangrijkste kenmerken:

- Plaatstalen frame met kunststof bovenzijde staand synoniem voor stevigheid en licht in gewicht.
- 2 gekoppelde modules:
 - 1 afneembare gereedschapskoffer,
 - 1 module met 2 laden, 95 mm in hoogte,
 - 1 uittrekbare kunststof bak, 66 mm hoog, en 1 lade 295 mm in hoogte.
- Extra grote wielen (160 mm), binnenin de bezuizing voor vereenvoudiging van transport -bijv. op trappen.
- Centraal veiligheidsslot voor het afsluiten van de twee laden onderste module.
- Laden met kogellagergeleiding met dubbele klemhaak.
- Telescopische aluminium handgreep.
- Compartiment voor kleine delen in bovenste module.
- Onderste lade is voorzien van dubbele laden geleidingop kogels

Aanbevolen assortimenten: 5941VU/M, 5940/SBK and 5915VU/5

* Kleuren verkrijgbaar op verzoek



C41H-O



C41H-W

C41H-Y

C41H-R

C41H-V

C41H-B

C41H-G

C41H-N

21 kg

		€		
C41H-O	RAL 2011	649,00	1	041000002
C41H-N	RAL 9005	649,00	1	041000005
C41H-B	RAL 5002	649,00	1	041000006
C41H-R	RAL 3000	649,00	1	041000008
C41H-G	RAL 7016	649,00	1	041000010
C41H-Y	RAL 1023	649,00	1	041000012
C41H-W	RAL 9016	649,00	1	041000021
C41H-V	RAL 6016	649,00	1	041000024

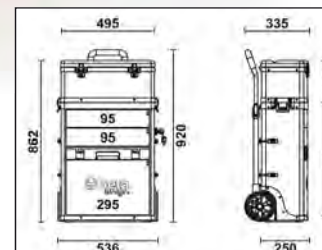
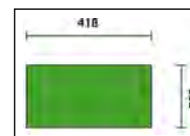

C41H/CE

Inzetbak met uitneembare vakverdeling. Vervaardigd uit kunststof

1,3 kg

C41H/CE	€ 45,50	1	041000916
---------	---------	---	-----------



C42H

Trolley, drie compartementen

Belangrijkste kenmerken:

- Plaatstalen constructie gecombineerd met kunststof delen, met als resultaat, een opmerkelijke robuustheid en een laag gewicht.
- 3 afneembare modules:
 - 1 top gereedschapskoffer, 220 mm hoog
 - 1 centrale gereedschapskoffer, 180 mm hoog
 - 1 bodem gereedschapskoffer met wielen, 320 mm hoog.
- Extra grote wielen (ø 160 mm).
- Telescopische handgreep, verstelbaar in 3 posities.
- Voorzien van een snel ontgrendelsysteem; eenvoudig en snel toegang tot de alle koffers.
- Bovenste koffer voorzien van inlegbak en 3 delig vakverdeling in de deksel.
- Is ook te gebruiken met twee koffers.

Aanbevolen assortimenten: 5940/SBK and 5915VU/5

14 kg

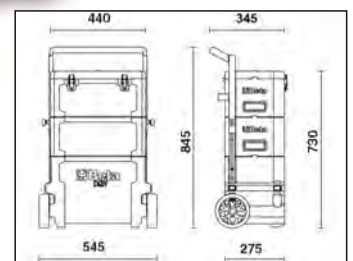

C42H

€ 450,00 1 042000002

Beta

CX49-G

Multifunctionele werkplaats wagen.

Is te gebruiken als verrijdbare werkplaats voor diagnose apparatuur, labtops, tetsapparaten en acculaders.

SPECIFICATIES

- Gelakt stalen frame; ongevenaarde stijfheid en stevigheid
- Ergonomische handgreep
- 2-niveau's topblad
- Uittrekbare lade voor het plaatsen van een klein toetsenbord
- 1 plank in hoogte verstelbaar, 1 vaste plank
- 4 handige kabelhouders aan zijkant, vervaardigd uit kunststof
- 2 handige opbergvakken aan zijkant
- 2 vaste achterwielen Ø 160 mm
- 2 2 zwenkwielen voorzijdes Ø 100 mm (een met rem)
- Gewicht: 36 kg

CX49-G

€ 851,00 1 049000102

1099 mm
460 mm
435 mm



CA49-G

Multifunctionele werkplaats wagen met deur

Is te gebruiken als verrijdbare werkplaats voor diagnose apparatuur, labtops, tetsapparaten en acculaders.

SPECIFICATIES

- Gelakt stalen frame; ongevenaarde stijfheid en stevigheid
- Ergonomische handgreep
- 2-niveau's topblad
- Uittrekbare lade voor het plaatsen van een klein toetsenbord
- 1 plank in hoogte verstelbaar, 1 vaste plank en afsluitbaar door een deur
- 4 handige kabelhouders aan zijkant, vervaardigd uit kunststof
- 2 handige opbergvakken aan zijkant
- 2 vaste achterwielen Ø 160 mm
- 2 2 zwenkwielen voorzijdes Ø 100 mm (een met rem)
- Gewicht: 36.5 kg

CA49-G

€ 955,00 1 049000112



1099 mm
460 mm
435 mm

4900-COVER C49

Nylon beschermhoes voor multifunctionele wagen artikel C49

4900-COVER C49

€ 43,50 1 049000930



C48M

Elektrische transportwagen met buisvormige rasterwanden

Compacte afmetingen en veelzijdig gebruik maken de C48M transportwagen de ideale oplossing voor het transporteren van zware lasten (dozen, containers, omvangrijke voorwerpen, onderdelen van apparatuur) met behulp van de ondersteunende elektrische stand in alle veiligheid, ook op moeilijk toegankelijke plaatsen en in werkomgevingen die niet kunnen toegankelijk zijn via conventionele vorkheftrucks.

Dit resulteert in aanzienlijk verminderde gevaren voor werker - bijv. fysieke aandoeningen veroorzaakt door het overmatig belasten door het tillen en trekken.

Gemotoriseerd platform, met 24V - 400W motor met 2x12V 33Ah batterijvoeding en Curtis-stuurkaart.

Laadvloer van stevig staal, bekleed met antisliprubber, met ronde buisvormige rasterwanden om te voorkomen dat voorwerpen tijdens het transport er vanaf kunnen vallen.

De rasterwanden kunnen worden verwijderd om tegemoet te komen aan individuele transportvereisten.

De bedieningsconsole is uitgerust met het volgende:

- ontstekingsleutel
- snelheidsregelknop
- viindergrepen aan de zijkant voor tractiecontrole
- onderbroken pieptoon, die wordt geactiveerd bij achteruitrijden
- batterijoplaadindicator
- uitschakelknop voor elektrische remmen
- noodrem met slagdrukknop.

Uitgerust met 2 pneumatische aandrijfwielen (Ø 260 mm) en 2 zwenkbare rubberen wielen (Ø 150 mm), elektromagnetische rem en differentieel.

Geleverd met een externe acculader, 220V / 50Hz - V / A 24/12

FUNCTIONELE SPECIFICATIES

Draagvermogen: 400 kg

Rijsnelheid: 4-6 km / u (instelbaar)

Levensduur batterij: 4 uur

Maximaal toegestane helling bij volledige belasting: 6%

Maximaal toegestane helling met 100 kg belasting: 18%

Veiligheid eigenschappen:

Elektronische rem

Zoemer

Bescherming tegen beknelling

Batterij-indicator

Curtis controlekaart

TECHNISCHE SPECIFICATIES

Totale afmetingen: 1280x630x1100h mm

Nuttige afmetingen laadvloer met panelen: 1180x580 mm

Nuttige afmetingen laadvloer zonder panelen: 1260x620 mm

Hoogte laadvloer vanaf vloer: 320 mm

Hoogte batterijvak vanaf vloer: 65 mm

Gewicht met batterijen: 140 kg

140 kg

C48M

€ 3.050,00 1 048000230

C48P

Opklapbare transportwagen

Belangrijkste kenmerken:

- Laadplatform van versterkt polypropyleen (PP), met antislipcoating en TPV-inzetstukken voor hoekbescherming
- Opklapbare handgreep voor snelle, compacte opslag
- Vier streeploze zwenkwielen, Ø 125 mm: 2 vaste en 2 zwenkwielen met rem
- Maximale capaciteit: 300 kg.
- Werkbreedte laadplatform: 705 mm
- Diepte laadplatform: 480 mm
- Hoogte laadplatform: 200 mm



11 kg

C48P

€ 286,00 1 048000030

Beta
BRUTUS

400
kg

CE

1100
630
1280



C51

Trolley - gereedschapswagen

- Drie bladen bedekt met anti-slip rubber
- Ergonomisch handvat
- Mogelijkheid om het centraal werkblad te positioneren op twee plaatsen
- Laadcapaciteit: 240 kg
- Vier wielen Ø 100 mm: 2 vaste en 2 stuurwielen waarvan 1 voorzien van een rem
- Statische laad capaciteit: 200 kg (verdeeld over 3 plateaus)

21 kg

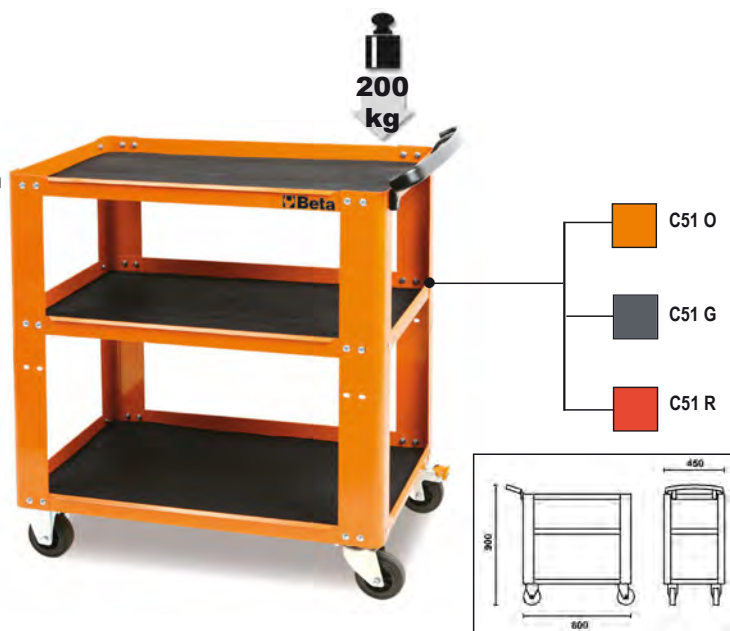

		€		
C51 O	RAL 2011	318,00	1	051000001
C51 G	RAL 7016	318,00	1	051000002
C51 R	RAL 3000	318,00	1	051000003

RSC51

service wagen met 3 laden

Belangrijkste kenmerken:

- ABS versterkt werkblad, solide en stevig
 - Multifunctionele bovenkant met anti-valranden en 8 gaten voor schroevendraaiers
 - 3 laden (588x367 mm) met kogelgelagerde geleiders, 70 mm hoog
 - Ladebodems beschermd door schuimrubberen matten
 - Elke lade biedt plaats aan maximaal 4 stuks 1/4 inlays
 - Gecentraliseerd veiligheidsslot vooraan
 - Handige schroevendraaiërhouder aan de zijkant meegeleverd
 - Twee ingebouwde spuitbushouders aan de zijkant
 - Grote onderste plank beschermd door een anti-olie en anti-benzine rubberen mat
 - 4 wielen, Ø 125 mm: 2 bokwielen en 2 zwenkwielen (één met rem)
- Statisch draagvermogen: 400 kg
• Capaciteit van elke lade: 15 kg, gelijkmatig verdeeld

38 kg

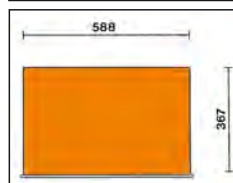

h	max
70 mm	15 kg

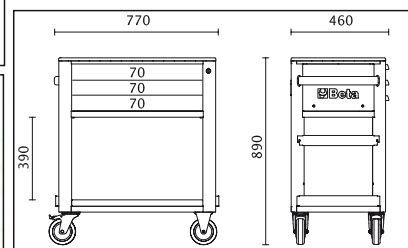

		€		
RSC51-FO	RAL 2011	641,00	1	051000300
RSC51-R	RAL 3000	641,00	1	051000303
RSC51-A	RAL 7016	641,00	1	051000307

2400 RSC24/MP

opvouwbare plank voor artikelen RSC24, RSC24A, RSC24AXLP/7, RSC51

- Te gebruiken als extra werkblad
- Afmetingen werkblad: 390x440 mm, beschermd door een anti-olie en anti-benzine rubberen mat
- Draagvermogen: 20 kg

3,4 kg

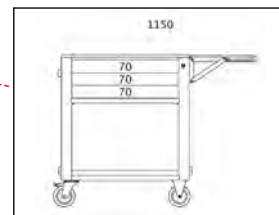

2400 RSC24/MP

€ 88,00 1 024004900

CP51

Robuuste magazijnwagen

- 2 werkbladen voorzien van rubber matten
- Ergonomische handgreep
- Vier hoogwaardige wielen Ø 125 mm: 2 vaste en 2 zwenkwielen met rem
- Statische laad capaciteit: 750 kg (verdeeld over de 2 werkbladen)

37 kg

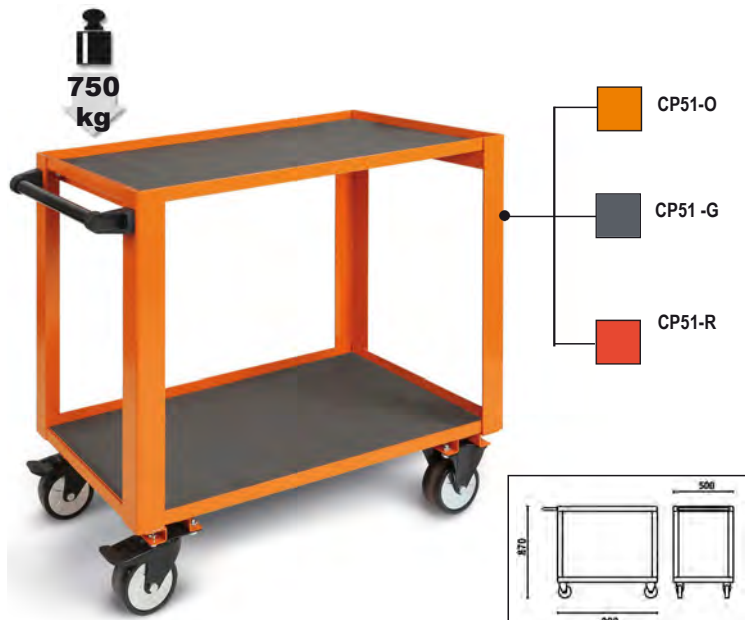

CP51 O	RAL 2011	433,00	1	051000501
CP51 G	RAL 7016	433,00	1	051000502
CP51 R	RAL 3000	433,00	1	051000503

CB52

Verrijdbare werkbank voor versnellingsbak en aandrijving voorzien van vloeistof opvangbak

Het aflopende topblad voorzien van afvoergaten maken het opvangen van de vloeistof mogelijk in de opvangbak

Voorzien van:

- 4 zwenkwielen, waarvan 2 met rem
- Gereedschaps lade
- Uitneembare opvangbak; capaciteit: 7 l
- 2 legplanken

Afmetingen: 1200x640x870 mm
Gewicht: 60 kg

60 kg



CB52-O		€ 866,00	1	052000201
--------	--	----------	---	-----------

C56P O

Opvouwbare werktafel

Compact en eenvoudig te dragen.
Werkblad (800x500mm, 30 mm dik) vervaardigd uit MDF en gegalvaniseerd plaatstaal, aan beide zijden te gebruiken.
Handgreep met rubber bescherming, voor het eenvoudig vervoeren.
Poten zijn voorzien van anti-slip materiaal.
Statisch laad vermogen: 250 kg

18,5 kg

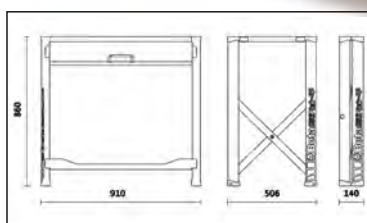

C56P O

€ 472,00 1 056000011

C56PL O

Opvouwbare werktafel, lichte uitvoering

Lichtgewicht, compact, eenvoudig te dragen.
Werkblad (800x500mm) vervaardigd uit gegalvaniseerd ijzeren plaat, aan een zijde te gebruiken, beschermd tegen olie en koolwaterstoffen d.m.v. een rubber mat.
Handgreep met rubber bescherming voor het comfortabel dragen.
Poten zijn voorzien van een anti-slip materiaal.
Statische laadcapaciteit: 200 kg

18,5 kg

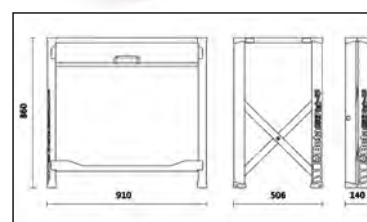

C56PL O

€ 425,00 1 056000021

C54S

Gereedschapskasten Cargo

Zij zijn op grond van zorgvuldig onderzoek bij vakbekwame professionele gebruikers ontworpen en bieden ideale oplossingen om prettig en doelmatig te kunnen werken.

De geperforeerde panelen aan de binnenkant van de twee deuren kunnen eveneens worden opengeslagen voor meer opbergruimte.

De gereedschapskasten CargoEvolution bieden de mogelijkheid twee extra panelen (optioneel) C53ANS en C53AND te monteren, waardoor de opbergcapaciteit toeneemt.

Voornaamste kenmerken:

- 1 lade met telescoopgeleiding.
- Mogelijkheid tot eenvoudige herindeling naar eigen keuze van de gereedschappen.
- Centraal veiligheidsslot voor schuifdeuren en lade.
- Lege kunststof inleg voor voor 1/2" dopsleutels en toebehoren.



C54S-O

37 kg

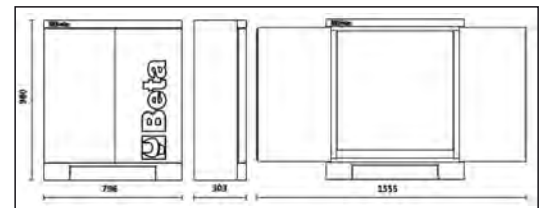

C54S-O

RAL 2011

€ 800,00



1



054000301

Beta

C57SA

MasterCargo werkbank

- Model met gereedschapswand (C57P) en een ladenkast.

Ladenkast: 5 laden, 588x367 mm, 3 90 mm hoog, 1 180 mm hoog en 1 280 mm hoog, met kogellagergeleiding. Is geschikt voor voorgevormde inlegbakken. Centraal veiligheidsslot. Gereedschapswand is voorzien van gaten in de achterwand voor muurbevestiging. Verticaal opende aluminium rolluik, met slot. Drie afneembare geperforeerde panelen voor ophangen van gereedschappen.

Multiplex houten werkblad, voorzien van kunststoflaminaat met voorgeboorde gaten voor bankschroef artikel 1599/F150 - 1599GI/150 optioneel te bestellen.



C57SA-O

205 kg



C57S/A-G

C57S/A-R

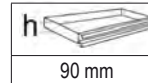

90 mm	30 kg
180 mm	40 kg
280 mm	40 kg

90
90
180
280

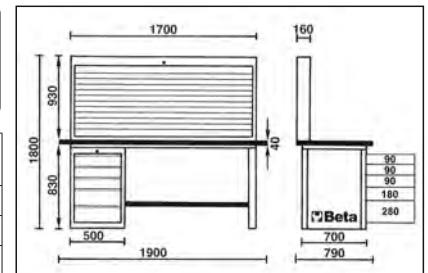

		€		
C57S/A-O	RAL 2011	5.480,00	1	057001005
C57S/A-G	RAL 7016	5.480,00	1	057001205
C57S/A-R	RAL 3000	5.480,00	1	057001405

C57SD

MasterCargo werkbank

- Model met een ladenkast.

Ladenkast: 5 laden, 588x367 mm, 3 90 mm hoog, 1 180 mm hoog en 1 280 mm hoog, met kogellagergeleiding. Geschikt voor voorgevormde inlegbakken. Centraal veiligheidsslot.

Multiplex houten werkblad, voorzien van kunststoflaminaat met drie voorgeboorde gaten voor bankschroef artikel 1599F/150 - 1599GI/150 optioneel te bestellen.



C57S/D-O



90 mm	30 kg
180 mm	40 kg
280 mm	40 kg

90
90
180
280



C57S/D-G



C57S/D-R

158 kg

		€		
C57S/D-O	RAL 2011	3.880,00	1	057001004
C57S/D-G	RAL 7016	3.880,00	1	057001204
C57S/D-R	RAL 3000	3.880,00	1	057001404

C57SB

MasterCargo werkbank

- Model met gereedschapswand (C57P) en twee ladenkasten.

Ladenkast: 5 laden, 588x367 mm, 3 90 mm hoog, 1 180 mm hoog en 1 280 mm hoog, met kogellagergeleiding.

Is geschikt voor voorgevormde inlegbakken. Centraal veiligheidsslot.

Gereedschapswand is voorzien van gaten in de achterwand voor muurbevestiging.

Verticaal opende aluminium rolluik, met slot.

Drie afneembare geperforeerde panelen voor ophangen van gereedschappen.

Multiplex houten werkblad, voorzien van kunststoflaminaat met voorgeboorde gaten voor bankschroef artikel 1599/F150 - 1599GI/150 optioneel te bestellen.



C57S/B-O

243 kg



C57S/B-G



C57S/B-R

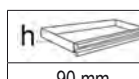

max

90 mm	30 kg
180 mm	40 kg
280 mm	40 kg

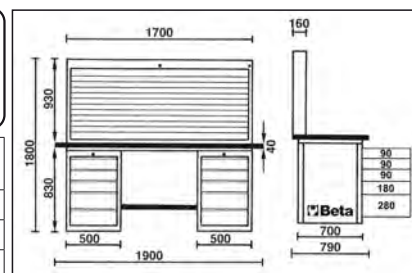

		€		
C57S/B-O	RAL 2011	6.830,00	1	057001006
C57S/B-G	RAL 7016	6.830,00	1	057001206
C57S/B-R	RAL 3000	6.830,00	1	057001406

C57SC

MasterCargo werkbank

- Model met twee ladenkasten.

Ladenkast: 5 laden, 588x367 mm, 3 90 mm hoog, 1 180 mm hoog en 1 280 mm hoog, met kogellagergeleiding.

Geschikt voor voorgevormde inlegbakken. Centraal veiligheidsslot.

Multiplex houten werkblad, voorzien van kunststoflaminaat met drie voorgeboorde gaten voor bankschroef artikel 1599F/150 - 1599GI/150 optioneel te bestellen.



C57S/C-O

196 kg



max

90 mm	30 kg
180 mm	40 kg
280 mm	40 kg



C57S/C-G



C57S/C-R

		€		
C57S/C-O	RAL 2011	5.230,00	1	057001003
C57S/C-G	RAL 7016	5.230,00	1	057001203
C57S/C-R	RAL 3000	5.230,00	1	057001403

C57SP

gereedschapskast

Gereedschapskast met twee gaten aan achterzijde voor muurbevestiging. Aluminium rolluik, verticaal instelbaar met veiligheidsslot. Drie uitneembare geperforeerde panelen voor gereedschapshaken.

46 kg

		€		
C57SP-O	RAL 2011	1.600,00	1	057001020
C57SP-G	RAL 7016	1.600,00	1	057001220
C57SP-R	RAL 3000	1.600,00	1	057001420



C57SP G

C57SP R

5700LAMP

Lamp voor MasterCargo werkbank

- Stevige plaatstaal structuur bestaande uit vier onderdelen; met inbegrip van schroeven voor de montage.
- 1120-Lumen LED buis, 4000K, 14W
- Voeding 230V.
- Geleverd zonder kabel.

9 kg

	€		
5700LAMP	402,00	1	057000005

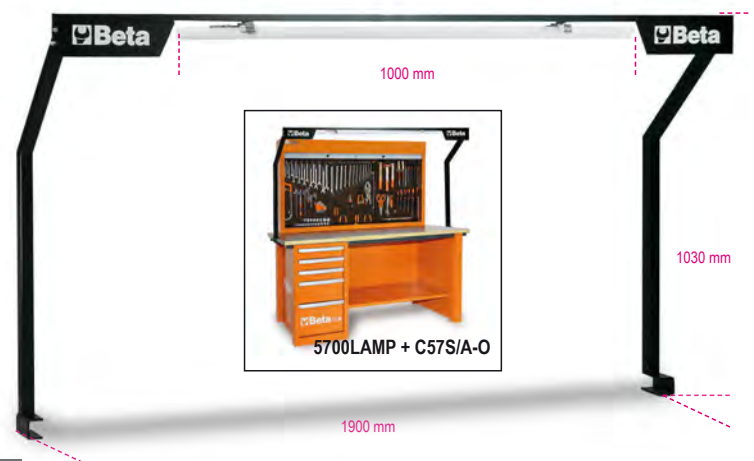

C58P

Paneel gereedschapshouder

- Rolluik met veiligheidssluiting gemaakt van gelakt aluminium.
- Twee verwijderbare geperforeerde panelen tbv gereedschap.

46,8 kg

		€		
C58P-O	RAL 2011	1.205,00	1	058000221
C58P-G	RAL 7016	1.205,00	1	058000222
C58P-R	RAL 3000	1.205,00	1	058000223



C58P-G



C58P-R



C58P-O

PV

Gereedschapspaneel

	LxA mm		€		
PV1	1000x920	10,2	229,50	1	088880010
PV1,5	1500x920	14,2	304,00	1	088880015



C56W

Werkbank met houten blad

- Multiplex houten werkblad voorzien van voorgeboorde gaten voor een bankschroef (1599F/125 - 1599GI/125, optioneel te bestellen).
- Stalen constructie ondersteund door 6 poten
- Statische belasting: 1.200 kg
- Geschikt voor gereedschapswand C57P; kan echter niet erop gemonteerd worden.
- Twee laden met slot.
- Kan gefixeerd worden aan de vloer.

86 kg



		€		
C56W-O	RAL 2011	1.315,00	1	056000251
C56W-G	RAL 7016	1.315,00	1	056000252
C56W-R	RAL 3000	1.315,00	1	056000253

C56B

Werkbank met houten werkblad

Belangrijkste kenmerken:

- Multiplex houten werkblad voorzien van voorgeboorde gaten voor een bankschroef (1599F/125 - 1599GI/125, optioneel te bestellen).
- Staal constructie met 4 steunpoten.
- Statische laadcapaciteit: 800 kg.
- Extra legplank.
- Kan gefixeerd worden aan de vloer.

54,5 kg



		€		
C56B-O	RAL 2011	804,00	1	056000401
C56B-G	RAL 7016	804,00	1	056000402
C56B-R	RAL 3000	804,00	1	056000403

C56

Werkbank

- Werkblad vervaardigd uit geveerd plaatstaal met een opstaande rand
- Stalen constructie ondersteund door 6 poten
- Statische belasting: 1.200 Kg
- Geschikt voor gereedschapswand C57P; kan echter niet gemonteerd worden
- Twee laden met slot
- Kan gefixeerd worden aan de vloer

82 kg



		€		
C56-O	RAL 2011	1.086,00	1	056000201
C56-G	RAL 7016	1.086,00	1	056000202
C56-R	RAL 3000	1.086,00	1	056000203

C56M

Werkbank

- Werkblad beschermd door zowel rubber mat als aluminium anti slip plaat.
- belastbaar tot : 2 T.
- Geschikt voor gereedschapswand C57P.
- Drie afsluitbare laden.

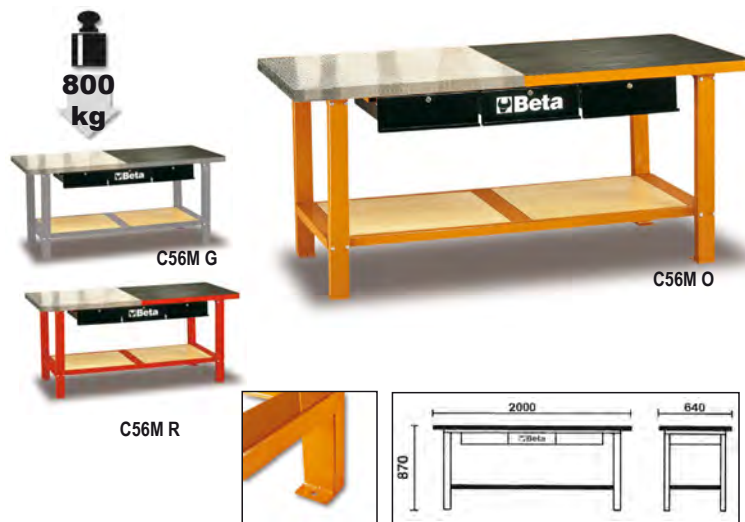

80 kg

		€		
C56M O	RAL 2011	1.590,00	1	056000050
C56M G	RAL 7016	1.590,00	1	056000053
C56M R	RAL 3000	1.590,00	1	056000054

C58B

Werkbank met houten werkblad

Belangrijkste kenmerken:

- Multiplex houten werkblad voorzien van voorgeboorde gaten voor een bankschroef (1599F/125 - 1599GI/125, optioneel te bestellen).
- Staal constructie met 4 steunpoten.
- Statische laadcapaciteit: 800 kg.
- Extra legplank.
- Kan gefixeerd worden aan de vloer.

44 kg



		€		
C58B-O	RAL 2011	732,00	1	058000401
C58B-G	RAL 7016	732,00	1	058000402
C58B-R	RAL 3000	732,00	1	058000403

C58M

Werkbank

- Metalen werkblad volledig bedekt met een verwijderbare rubberen antislipmat.
- Onderste plank van massief hout.
- Statisch draagvermogen: 800 kg.
- Passend bij paneelgereedschapshouder C58P; kan niet aan het werkblad worden bevestigd.
- 2 laden met sloten.
- Kan aan de vloer worden bevestigd.
- Aluminium werkblad C58M/PA op aanvraag leverbaar.

65 kg



		€		
C58M-O	RAL 2011	1.051,00	1	058000300
C58M-G	RAL 7016	1.051,00	1	058000302
C58M-R	RAL 3000	1.051,00	1	058000303

C59A

"Endurance" werkbank met een ladenblok met zes laden

Belangrijkste kenmerken:

- Houten werkblad vervaardigd uit multiplex, met voorgeboorde gaten voor bankschroef artikel 1599F/125 - 1599GI/125 (optioneel te bestellen).
- 6 laden (588x367 mm) met kogellager geleiding:
- 4 laden, 70 mm hoog
- 1 laden, 140 mm hoog
- 1 laden, 290 mm hoog.
- Ladenbodems beschermd door rubber matten.
- Laden zijn geschikt voor kunststof inlegbakken.
- Centraal veiligheidsslot aan voorzijde.
- Extra legplank.
- Geschikt voor papierrolhouders (2400 RSC24/PC) en spuitbushouder (2400 RSC24/PF-), optioneel te bestellen.

115 kg



C59A O



C59A A



C59A R

1500 kg



h	max
70 mm	25 kg
140 mm	30 kg
280 mm	35 kg

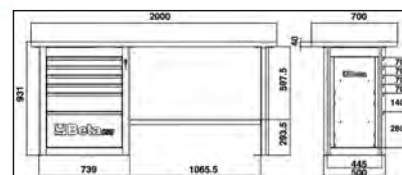

		€		
C59A-O	RAL 2011	2.110,00	1	059000011
C59A-A	RAL 7016	2.110,00	1	059000031
C59A-R	RAL 3000	2.110,00	1	059000051

C59B

"Endurance" werkbank met 2 ladenblokken met zes laden

Belangrijkste kenmerken:

- Houten werkblad vervaardigd uit multiplex, met voorgeboorde gaten voor bankschroef artikel 1599F/125 - 1599GI/125 (optioneel te bestellen).
- 12 laden (588x367 mm) met kogellager geleiding:
- 8 laden, 70 mm hoog
- 2 laden, 140 mm hoog
- 2 laden, 280 mm hoog.
- Ladenbodems beschermd door rubber matten.
- Laden zijn geschikt voor kunststof inlegbakken.
- Centraal veiligheidsslot aan voorzijde.
- Extra legplank.
- Geschikt voor papierrolhouders (2400 RSC24/PC) en spuitbushouder (2400 RSC24/PF-), optioneel te bestellen.

155 kg



C59B O



C59B A



C59B R

1500 kg

h	max
70 mm	25 kg
140 mm	30 kg
280 mm	35 kg

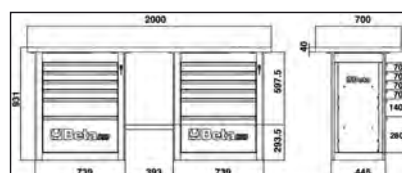

		€		
C59B-O	RAL 2011	2.740,00	1	059000012
C59B-R	RAL 3000	2.740,00	1	059000052
C59B-A	RAL 7016	2.740,00	1	059000032

C59C

"Endurance" werkbank met een ladenblok met zes laden, korte uitvoering

Belangrijkste kenmerken:

- Houten werkblad vervaardigd uit multiplex, met voorgeboorde gaten voor bankschroef artikel 1599F/125 - 1599GI/125 (optioneel te bestellen).
- 6 laden (588x367 mm) met kogellager geleiding:
 - 4 laden, 70 mm hoog
 - 1 laden, 140 mm hoog
 - 1 laden, 280 mm hoog.
- Ladenbodems beschermd door rubber matten.
- Laden zijn geschikt voor kunststof inlegbakken.
- Centraal veiligheidsslot aan voorzijde.
- Extra legplank.
- Geschikt voor papierrolhouders (2400 RSC24/PC) en spuitbushouder (2400 RSC24/PF-), optioneel te bestellen.

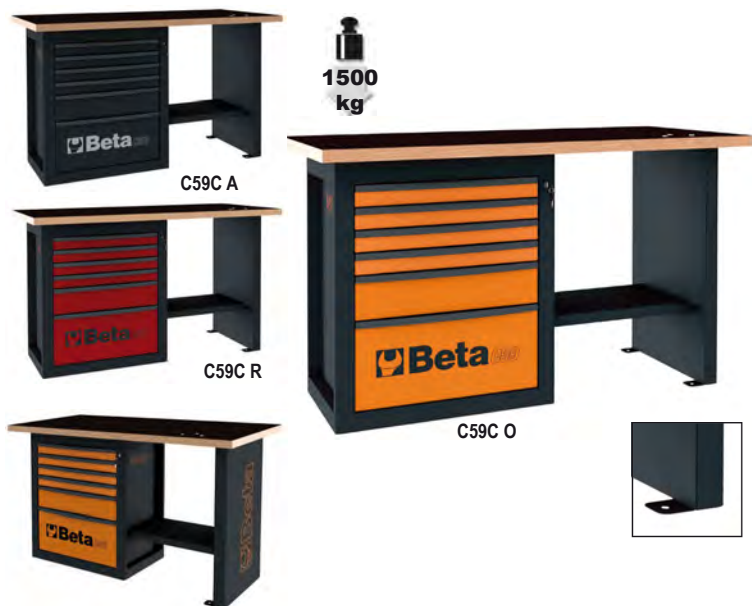

105 kg

		€		
C59C-O	RAL 2011	1.890,00	1	059000013
C59C-R	RAL 3000	1.890,00	1	059000053
C59C-A	RAL 7016	1.890,00	1	059000033

h	max
70 mm	25 kg
140 mm	30 kg
280 mm	35 kg

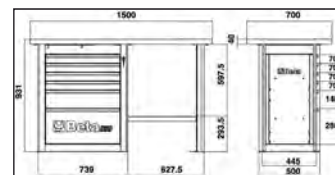

9562T2

Werkplaats mat, 200x160 cm

- Beschermt de vloer tegen olie en benzine vlekken, milieu vriendelijk
- Eenvoudig te reinigen, anti slip, onderkant mat voorzien van rubberlaag.



	L cm	€		
9562T2	200	293,00	1	095620200

Beta



WERKPLAATSINRICHTING



Om aan de marktvraag te voldoen, die meer en meer gericht is op kwaliteit, design en persoonlijke aanpassing, heeft Beta Utensili het "Racing System C55" ontwikkeld. Met deze modulaire garage inrichting, welke is in te delen naar uw wensen, is het mogelijk een moderne werkomgeving naar eigen inzicht te creëren.

Kwaliteit

Beta's beste Italiaans gemaakte kwaliteit om uw werkplaats in te richten.



Design

Verfijnde en aantrekkelijke afwerking voor een opgeruimde werkplaats.

Organisatie

Een praktische werkplaats is synoniem voor optimaal werken.

Modulair

Modulaire werkplaatsinrichting aangepast aan ruimte en wensen.





MADE IN ITALY

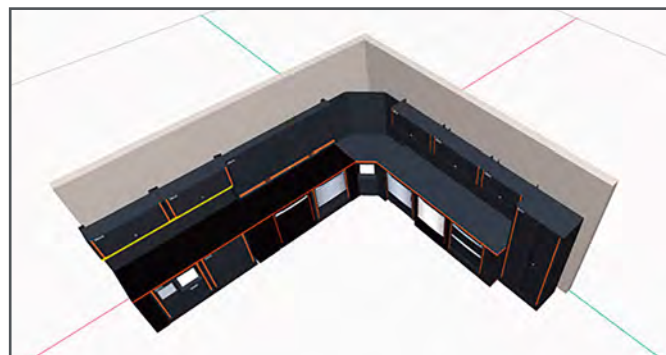

om uw gewenste werkplaats on line samen te stellen

Ga naar **www.rsc55.com**



Uw bedrijfskleur voor uw werkplaats!

RSC55 biedt u de mogelijkheid om de werkbanken en gereedschapswanden met rolluik te bestellen in een neutrale (grijze) uitvoering om vervolgens de verticale belijning naar eigen wens te voorzien van een kleur naar keuze. Er zijn 7 kleuren tape beschikbaar.

1. Bestel uw modules in een neutrale kleur

2. Bestel de gewenste verticale tape

Kies nu de kleur die u wenst of de kleuren van uw bedrijf

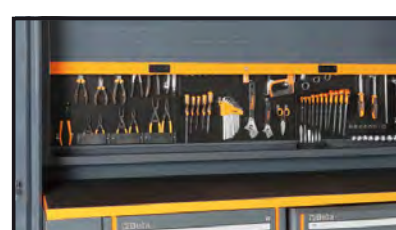
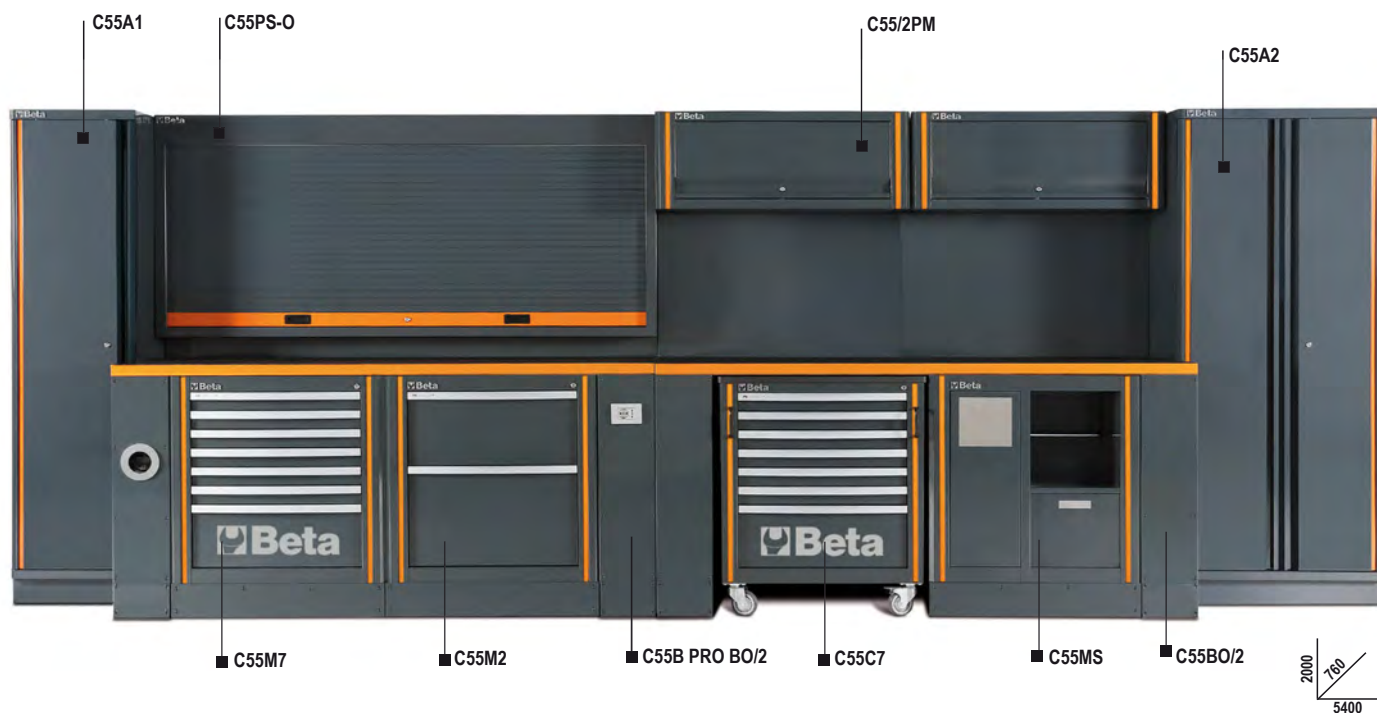

Volledige samenstelling als volgt:

- Enkele deur kast (C55A1)
- Dubbele deurs kast (C55A2)
- Werkbank (C55BO/2)
- Workbank met stroom en lucht (C55PRO BO/2)
- Gereedschapswagen met 7 laden (C55C7)
- Vast ladenblok met 2 grote laden (C55M2)
- Vast ladenblok met 7 laden (C55M7)
- Vast service blok(C55MS)
- Wandpaneel met bovenkasten (C55/2PM)
- Gereedschapswand met rolluik (C55PS-O)

C55AB

Werkplaats samenstelling

Samenstelling als volgt:

- Dubbele deurs kast (C55A2)
- Werkbank (C55BO/2)
- Vast ladenblok met 7 laden (C55M7)
- Vast service blok (C55MS)
- Wandpaneel met bovenkasten (C55/2PM)

407 kg



C55AB

€ P.O.A. 1 055000020



C55PB/3

Werkplaats samenstelling

Samenstelling als volgt:

- Werkbank (C55BO/2)
- Gereedschapswagen met 8 laden (C55C8)
- Vaste schuifladenkast met 2 grote laden (C55M2)
- Gereedschapswand met rolluik (C55PS-O)

334 kg



C55PB/3

€ P.O.A. 1 055000035



C55PB-PRO/7

Werkplaats samenstelling RSC55

Bestaande uit:

C55B

Werkbank met werkblad (2050x700 mm) bekleed met een stootvaste, krasvaste ABS-coating die bestand is tegen oliën en koolwaterstoffen.

Voorzien van:

- Gaten voor een bankschroef (1599F/150, apart te bestellen)
- Verticaal verstelbare voeten

C55M7

Vaste module met zeven laden (588x367 mm) met kogelgelagerde geleiders

- Aluminium openingssysteem over de gehele lengte van de lade
- Ladebodems beschermd door schuimrubberen matten
- Centrale vergrendeling vooraan
- Geschikt voor inlays

C55MS

Vaste servicemodule

- Ingebouwde afvalbak
- Papierrolcompartment
- Opberglade, 305x270 mm

C55/2PM + C55/PF

Gereedschapssysteem met 2 wandkasten

- 2 wandkasten, 1024x400x300 mm, met gasveren
- 2 onderkastpanelen, 1024x620x25 mm
- 2 onderkast geperforeerde gereedschapspanelen, 1024x620x25 mm

350 kg

C55PB-PRO/7

€ P.O.A. 1 055000065



C55PB-PRO/8

Werkplaats samenstelling RSC55

Bestaande uit:

C55B

Werkbank met werkblad (2050x700 mm) bekleed met een stootvaste, krasvaste ABS-coating die bestand is tegen oliën en koolwaterstoffen.

Voorzien van:

- Gaten voor een bankschroef (1599F/150, apart te bestellen)
- Verticaal verstelbare voeten

C55C7

Vrijrijdbare rolcabine met zeven laden (588x367 mm) met kogelgelagerde geleiders

- 4 zwenkwielen Ø 100 mm, 2 vaste en 2 zwenkwielen (een met rem)
- Aluminium openingssysteem over de gehele lengte van de lade
- Ladebodems beschermd door schuimrubberen matten
- Centrale vergrendeling vooraan
- Te voorzien van gethermovormde trays

C55MA

Vaste tweedeursmodule

- Push-pull openingssysteem
- Met slot
- Binnenplank, verticaal verstelbaar

C55PS

Gereedschapswand met rolluik en montageframe

- Aluminium rolluik, verticaal verstelbaar, met slot
- Uitneembaar geperforeerd gereedschapspaneel

347 kg

C55PB-PRO/8

€ P.O.A. 1 055000066



C55B/2

2-m-lange werkbank, passend in werkplaatscombinaties

Met een werkblad van (2050x700 mm) beschermd door een schokbestendig, krasvrije PVC coating, bestand tegen koolwaterstoffen

- Voorgeboorde gaten voor een bankschroef (1599F/150 - 1599GI/150, optioneel te bestellen)
- In hoogte verstelbare poten

1105 kg

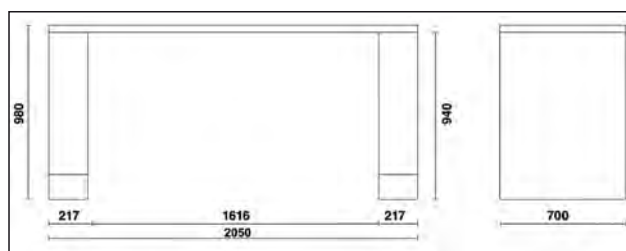
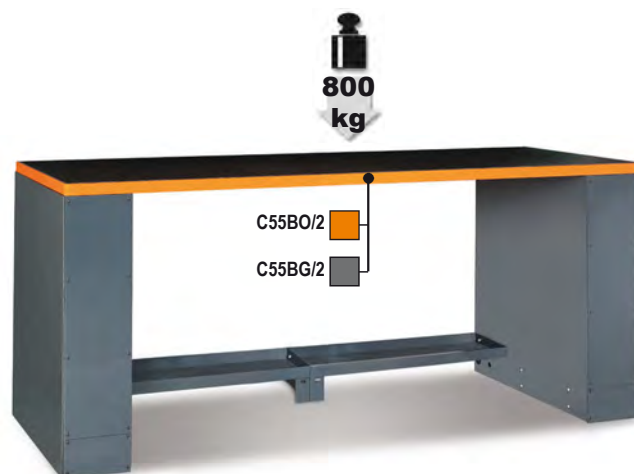

C55BO/2	€	1	055000101
C55BG/2	P.O.A.	1	055000111

C55PRO B/2

2-m-lange werkbank, passend in werkplaatsinrichting RSC55

Met werkblad (2050x700 mm) bedekt met een stootvaste, krasvaste PVC-coating, bestand tegen koolwaterstoffen

Inbouwstopcontacten en slanghaspel:

- Schuko stopcontact +16+10A
- EU-stekker 10A
- Perslucht unit met slanghaspel, Ø 8 mm, art. 1901BM/8, slanglengte: 10 m.
- Gaten voor een bankschroef (1599P/150 - 1599GI/150, apart te bestellen)
- Verticaal verstelbare poten

1110 kg

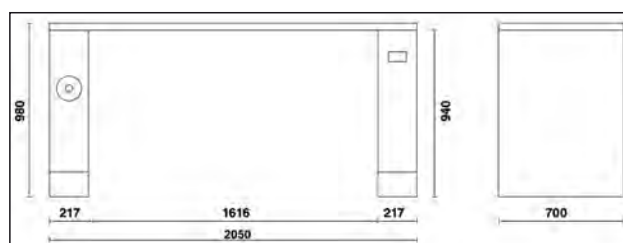
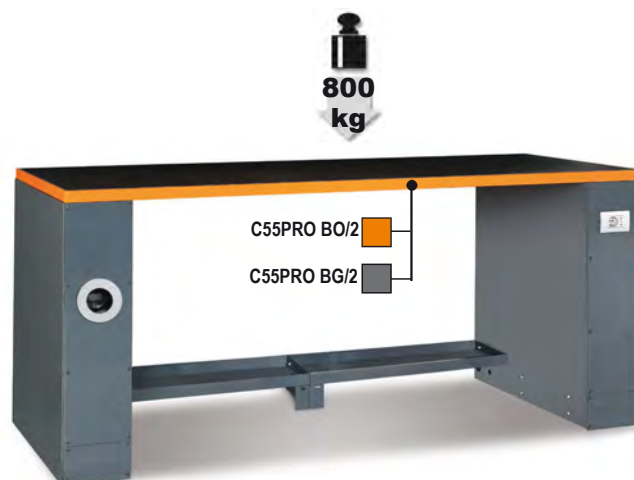

C55PRO BO/2	€	1	055000151
C55PRO BG/2	P.O.A.	1	055000171

C55B/2,8

2,8-m-lange werkbank, voor werkplaatsombinaties

Werkblad (2850x700 mm) beschermd door een schokbestendig, krasvrij PVC coating, bestendig tegen koolwaterstoffen

- Voorgeboorde gaten voor een bankschroef (1599F/150 - 1599GI/150, optioneel te bestellen)
- In hoogte verstelbare poten

129 kg

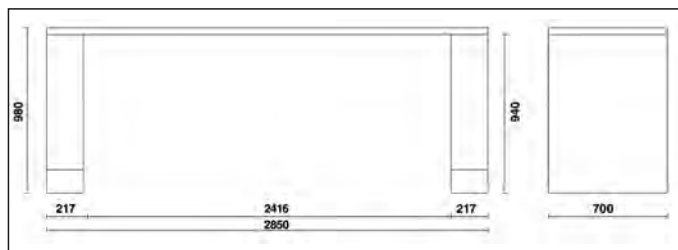
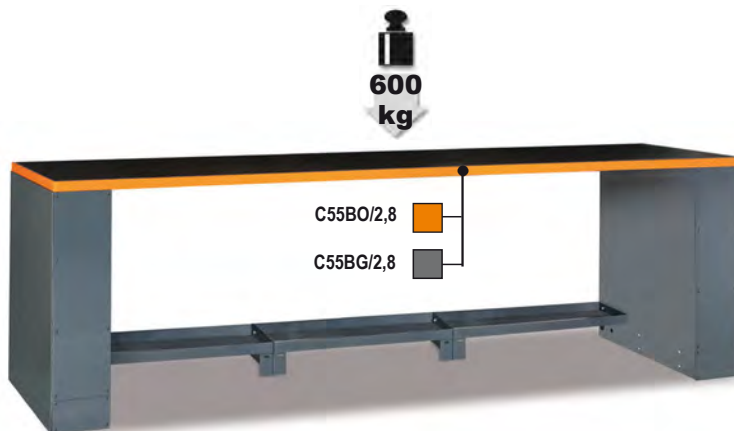

C55BO/2,8	€	P.O.A.	1	055000261
C55BG/2,8		P.O.A.	1	055000281

C55PRO B/2,8

2,8 m lange werkbank, voor werkplaatsinrichting RSC55

Met werkblad (2850x700 mm) bedekt met een stootvaste, krasvaste PVC-coating, bestand tegen koolwaterstoffen

Inbouwstopcontacten en slanghaspel:

- Schuko stopcontact +16+10A
- EU-stekker 10A
- Persluchtunit met slanghaspel, Ø 8 mm, slanglengte: 10 m.
- Gaten voor een bankschroef (1599F/150 - 1599GI/150, apart te bestellen)
- Verticaal verstelbare poten

134 kg

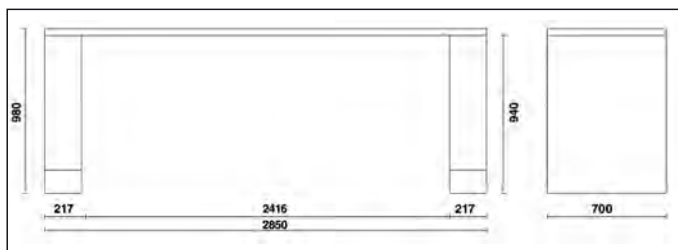
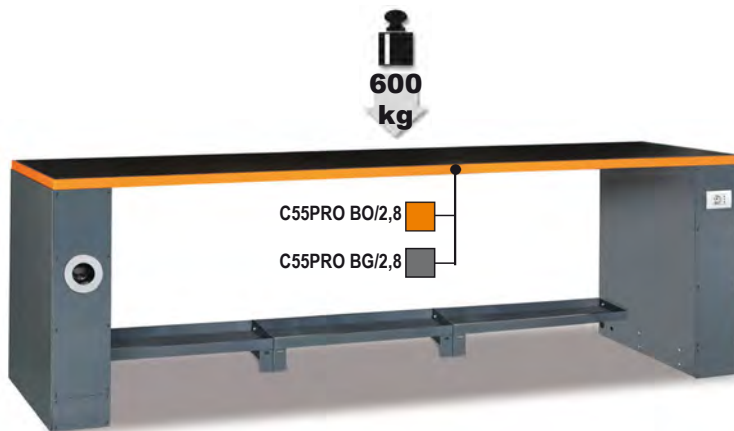

C55PRO BO/2,8	€	P.O.A.	1	055000271
C55PRO BG/2,8		P.O.A.	1	055000283

C55B-D4

4 meter lange werkbank met 1 dubbele centrale poot

Werkblad (4100x700 mm) beschermd door een schokbestendig, krasvrij PVC toplaag, bestendig tegen koolwaterstoffen

- Voorgeboorde gaten voor de bankschroef artikel 1599F/150 - 1599GI/150 (optioneel te bestellen)
- In hoogte verstelbare poten
- Dubbele centrale poot met opbergruimte achter wegklapbare deur, 365x750 mm

185 kg

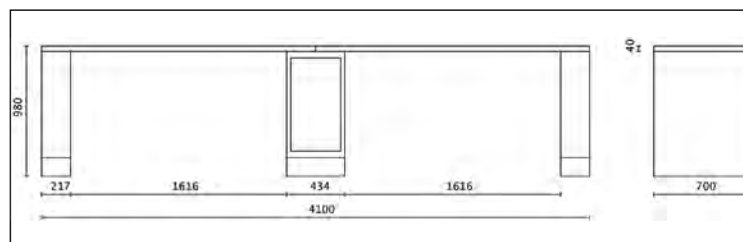

C55BO/D4	€	1	055000109
C55BG/D4	P.O.A.	1	055000119

C55PRO B-D4

Dubbele 4 m lange werkbank met centrale poot

Met werkblad (4100x700 mm) bedekt met een stootvaste, krasvaste PVC-coating, bestand tegen koolwaterstoffen

Inbouwstopcontacten en kabelhaspel:

- Schuko stopcontact +16+10A
- EU-stekker 10A
- Persluchtunit met slanghaspel, Ø 8 mm, kabellengte: 10 m.
- Gaten voor een bankschroef (1599F/150 - 1599GI/150, apart te bestellen)
- Verticaal verstelbare voeten
- Dubbele centrale poot met gereedschapsvak en deur, 365x750 mm

190 kg

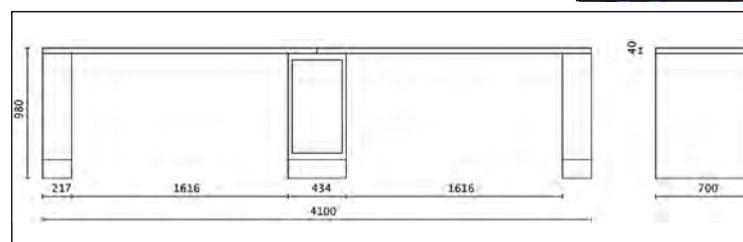
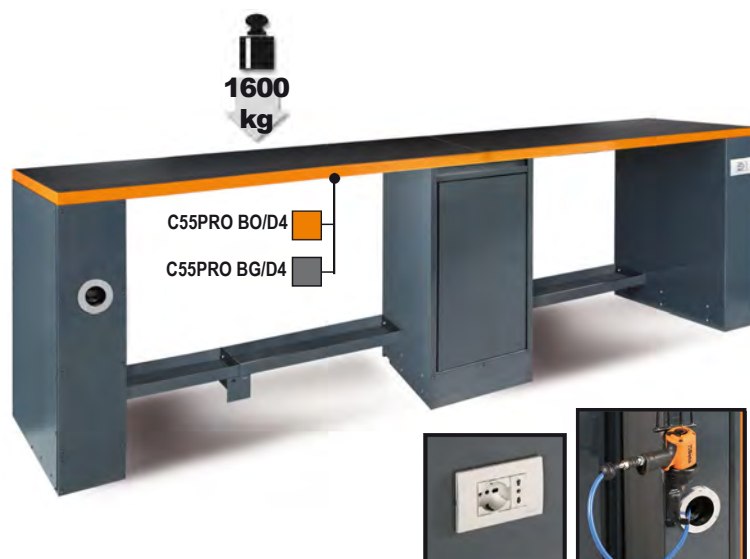

C55PRO-BO/D4	€	1	055000159
C55PRO-BG/D4	P.O.A.	1	055000179

 **Beta**

C55B/G

Universele poot voor werkbank

- In hoogte verstelbaar
- Opening aan voor- en zijkant

30 kg

C55B/G

€ P.O.A. 1 055000096

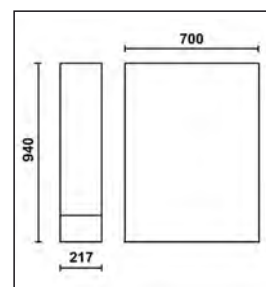

C55B/GAA

Universele poot voor werkbank met ingebouwde slanghaspel

- Ingebouwde automatische slanghaspel voor perslucht of koud water, Ø 8 mm
- Slanglengte: 10 m
- Met verticaal verstelbare poten
- Toegang aan voor- en zijkant

35 kg

C55B/GAA

€ P.O.A. 1 055000099

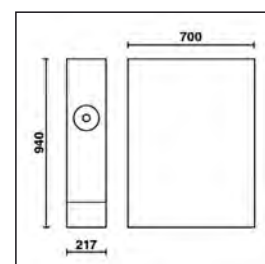

C55B/GDP

Dubbele poot voor het koppelen van werkbanken

- Papierrol houder vak
- Geheel afsluitbaar door deur
- In hoogte verstelbare poot

45 kg

C55B/GDP

€ P.O.A. 1 055000292

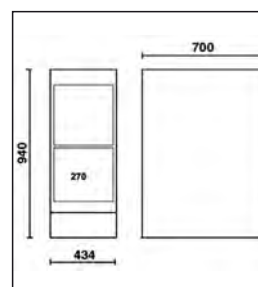

C55B/GDS

Dubbele poot voor het koppelen van werkbanken

- Opbergruimte door wegklapbare paneel, 365x750 mm
- In hoogte verstelbare poten

45 kg

C55B/GDS

€ P.O.A. 1 055000291

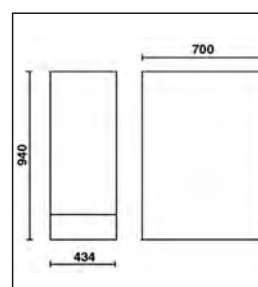

C55B/GE

Universele poot met elektriciteits aansluiting voor werkbank

- Schuko contactdoos+16+10A
- EU aansluiting +10A
- In hoogte verstelbaar
- Opening aan voor en zijkant

30 kg

C55B/GE

€ P.O.A. 1 055000097

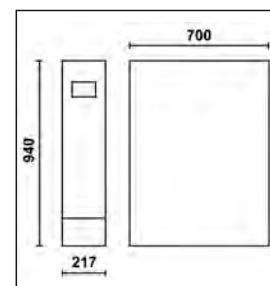

C55B/GAE

Universele poot met ingebouwde elektrische kabelhaspel voor werkbank, voor werkplaatsinrichting

- Ingebouwde automatische kabelhaspel met Schuko type stopcontact.
- Kabellengte: 15 m
- Met thermische beveiligingsschakelaar
- Met verticaal verstelbare poten
- Toegang aan voor- en zijkant

35 kg

C55B/GAE

€ P.O.A. 1 055000094

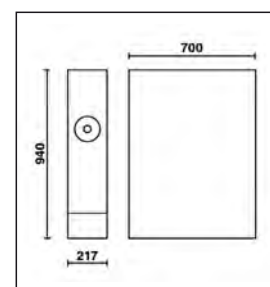
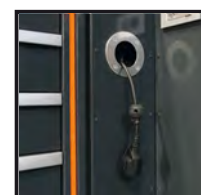

Beta

C55/PL-1,024

1 m lang werkblad voor werkbankverlenging

Werkblad van gelakt plaatstaal (1024x700 mm) bedekt met een stootvaste, krasvaste PVC-coating, bestand tegen koolwaterstoffen

21 kg

C55/PLO-1,024	€	1	055000130
C55/PLG-1,024	€	1	055000131



C55B PT/2

2 m lang werkblad voor werkbank, voor werkplaatsinrichting combinatie

Gelakt plaatstalen werkblad (2050x700 mm) bedekt met een stootvaste, krasvaste PVC-coating, bestand tegen koolwaterstoffen
Gaten voor een bankschroef (1599P/150 - 1599GI/150, apart te bestellen)

43 kg

C55BO PT/2	€	1	055000106
C55BG PT/2	€	1	055000116

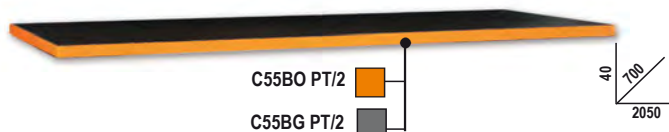

C55B PT/2,8

2,8 m lang werkblad voor werkbank, voor werkplaatsinrichting RSC55

Gelakt plaatstalen werkblad (2850x700 mm) bedekt met een stootvaste, krasvaste PVC-coating, bestand tegen koolwaterstoffen
Gaten voor een bankschroef (1599P/150 - 1599GI/150, apart te bestellen)

61 kg

C55BO PT/2,8	€	1	055000266
C55BG PT/2,8	€	1	055000286



C55RB

Schokbestendige krasvrije PVC mat, bestand tegen koolwaterstoffen

Ter bescherming van het werkblad.
C55RB/2: voor 2-m-lang werkblad
C55RB/2.8: voor 2.8-m-lang werkblad
C55RB/0.7: voor 700x700mm werkblad
C55RB/1: voor 1-m-lang werkblad

C55RB/2	€	1	055000195
C55RB/2,8	€	1	055000196
C55RB/0,7	€	1	055000199
C55RB/1	€	1	055000198



C55B/VS

Lage werkbanksteun voor werkplaatsinrichting, 0,8 m lang

Afmetingen: 800x230x60 mm

4 kg

C55B/VS	€	1	055000095
---------	---	---	-----------

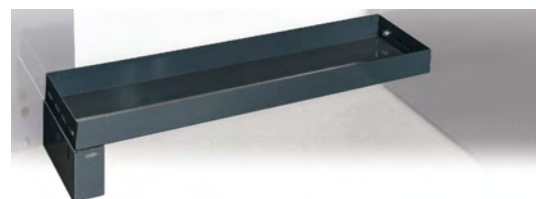

C55C7

Gereedschapswagen met zeven laden, passend in werkplaatscombinaties

7 laden (588x367 mm), met kogelgelagerde geleiding

- 4 wielen Ø 100 mm, 2 vaste (een met rem) en 2 zwenkwielen
- Ontsluiten van de aluminium laden over de gehele lengte van de laden
- Ladenbodems beschermd door zacht rubberen matten
- Centraal veiligheidsslot aan voorzijde
- Laden zijn geschikt voor zachte inlegbakken

79 kg

1000 kg

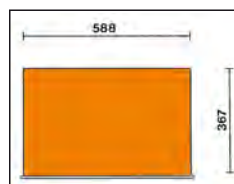

h	max
70 mm	30 kg
245 mm	40 kg

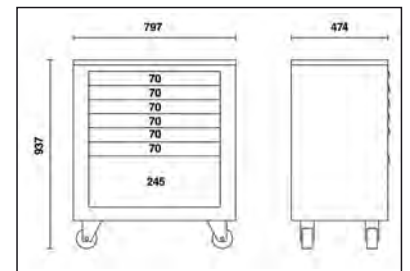

C55C7

€ P.O.A. 1 055000201

Beta

C55C8

Gereedschapswagen met acht laden, voor werkplaatscombinaties

- 8 laden (588x367 mm) met kogelgelagerde geleiding
- 4 wielen Ø 100 mm, 2 vaste (een met rem) en 2 zwenkwielen
- Ontsluiten van de aluminium laden over de gehele lengte van de laden
- Ladenbodems beschermd door zacht rubber matten
- Centraal veiligheidsslot aan voorzijde
- Laden zijn geschikt voor zachte inlegbakken

81 kg



h	max
70 mm	30 kg
175 mm	40 kg

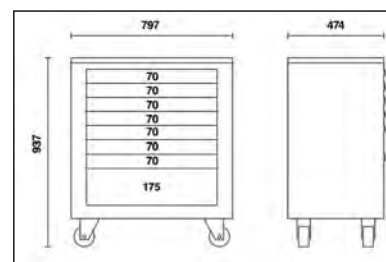
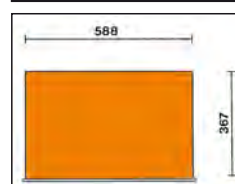

C55C8

€ P.O.A. 1 055000206

C55M2

Blok met 2 laden, als deel van een werkplaatsinrichting

- 2 laden (588x367mm) met kogellager geleiding
- Laden voorzien van aluminium opening greep over de gehele lengte van de laden
- Ladenbodems beschermd door zacht rubber matten
- Centraal veiligheidsslot

66 kg



h	max
280 mm	40 kg
385 mm	40 kg

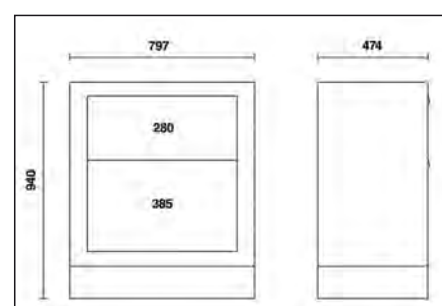
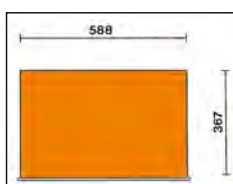

C55M2

€ P.O.A. 1 055000202

C55M4

Vast ladenblok met 4 laden, voor werkplaatsinrichting

4 laden (588x367 mm) met kogelgelagerde geleiding

- Ontsluiten van de laden over de gehele lengte door aluminium greep
- Ladenbodems beschermd door zacht rubber matten
- Centraal veiligheidsslot aan voorzijde

75 kg

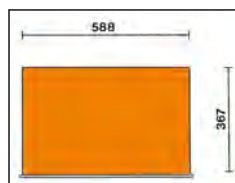

h	max
140 mm	30 kg
245 mm	40 kg

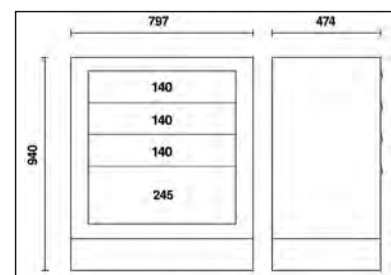

C55M4

€ P.O.A. 1 055000212

C55M7

Vast ladenblok met zeven laden passend in werkplaatscombinaties

7 laden (588x367 mm) met kogelgelagerde geleiding

- Ontsluiten van de aluminium laden over de gehele lengte van de laden
- Ladenbodems beschermd door zacht rubber matten
- Centraal veiligheidsslot aan voorzijde
- Laden zijn geschikt voor zachte inlegbakken

78 kg

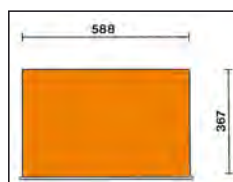

h	max
70 mm	30 kg
245 mm	40 kg

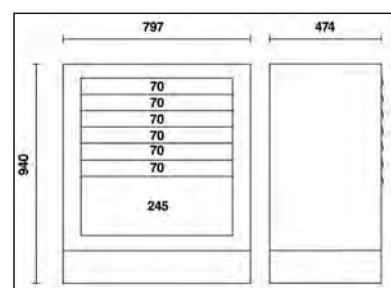

C55M7

€ P.O.A. 1 055000203

C55M8

Vaste module met 8 laden te combineren met werkplaats inrichting

8 laden (588x367 mm) met kogellager geleiding

- Ontsluiten van de laden over de gehele lengte door aluminium greep
- Ladenbodems beschermd door zacht rubber matten
- Centraal veiligheidsslot aan voorzijde
- Laden zijn geschikt voor zachte foam inlegbakken

📦 78,9 kg

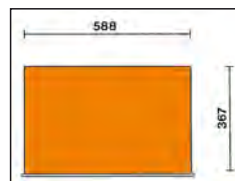

h	max
70 mm	30 kg
175 mm	40 kg

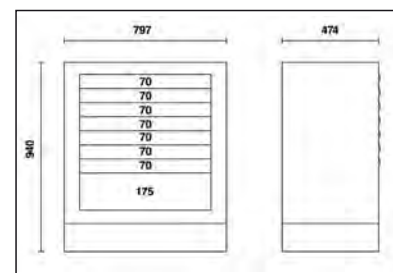

C55M8

€ P.O.A. 1 055000207

C55CS

Vaste module met ingebouwde afvalbakken, te combineren met werkplaats inrichting

- Uittrekbaar vak voor afval (588x465) op kogellager geleiding
- 2 ruime uitneembare bakken voor het scheiden van afval

📦 62 kg

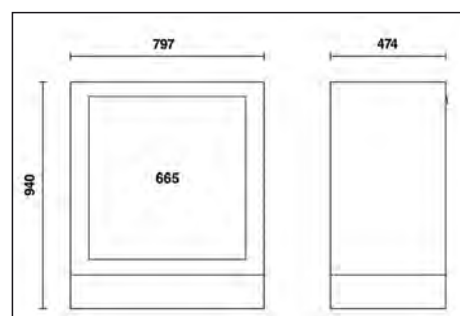

C55 CS

€ P.O.A. 1 055000208

C55MA

Vast twee deurs kast, passend in werkplaatscombinaties

- Kastdeur te openen door druk bevestiging
- Met slot
- Legplank in hoogte verstelbaar

75 kg

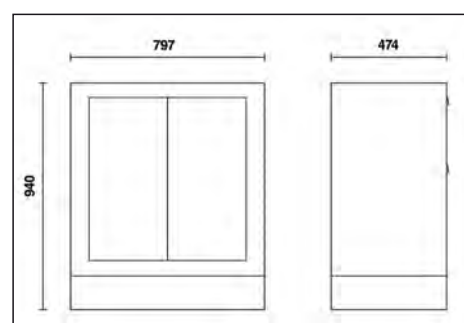

C55MA

€ P.O.A. 1 055000205

C55MDO

Vaste module voor oliedistributie, te combineren met werkplaatsinrichting

- 2 slanghaspels voorzien van een 7 meter lange 1/2" slang
- Compleet met 2 olieafgifte pistolen met digitale liter teller en automatische druppelvanger.
- Max. afgifte: 30 l/min
- Viscositeit: 8+2000 mPas

94 kg

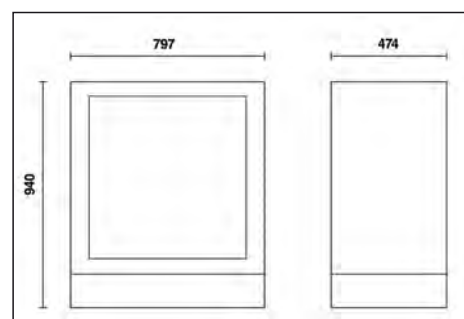

C55MDO

€ P.O.A. 1 055000210

C55MS

Vast service blok, als deel van een werkplaatsinrichting

- Ingebouwde afvalbak
- Papierrolhouder met perforatiekant
- Opberglade, 305x270 mm

75 kg

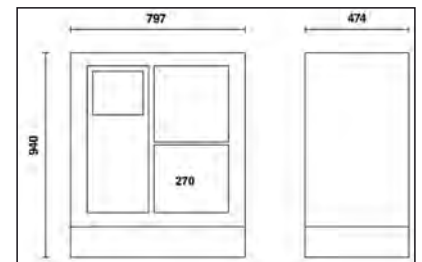

C55MS

€ P.O.A. 1 055000204

C55T3

Magazijnwagen

- 3 topbladen voorzien van anti-slip rubber matten
- Ergonomische handgreep
- Twee bevestigings mogelijk voor het middelste werkblad
- Vier wielen Ø 100 mm (twee met rem)
- Statische laad capaciteit: 200 kg (verdeeld over 3 bladen)

21 kg

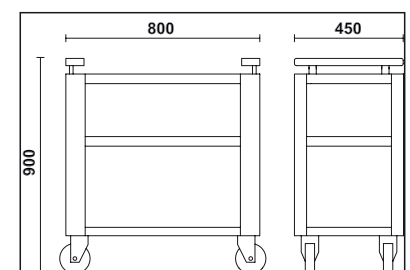

C55T3

€ P.O.A. 1 055000219

C55P/MCD

Dubbele centrale middensteunpaal

10 kg

C55P/MCD

€ P.O.A. 1 055000257



C55P/2MDX-SX

Rechtse/linkse steunpalen, paar

10 kg

C55P/2MDX-SX

€ P.O.A. 1 055000253



C55PM

Ophangkast voor werkplaatsinrichting, 1 meter breed

• Afmetingen: 1024x400x300 mm; voorzien van gasveren, vereenvoudigen het openen en sluiten van de deur

24 kg

C55PM

€ P.O.A. 1 055000302

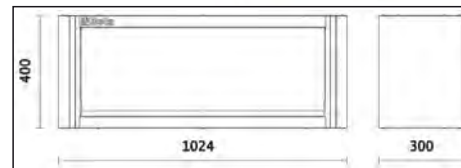

C55PFA-1,0

Zelfdragend geperforeerd paneel, 1 m breed, voor werkplaatsinrichting

Geperforeerd stalen gereedschapspaneel (1024x1020x25 mm)

11 kg

C55PFA-1,0

€ P.O.A. 1 055000316

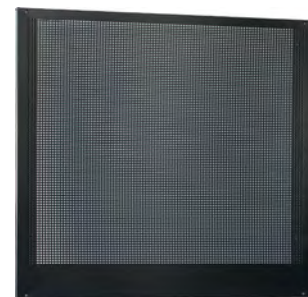

C55/PF

Geperforeerd gereedschapspaneel voor werkplaatsinrichting, 1 meter breed

• Geperforeerd gereedschapspaneel (1024x600 mm) ontworpen om te combineren met C55PT 1,0X0.6

6 kg

C55/PF

€ P.O.A. 1 055000307



C55PT1,0X0,6

Achterwandpaneel, 1 m breed

Afmetingen: 1024x620x25 mm

8 kg

C55PT1,0X0,6

€ P.O.A. 1 055000314



C55PTE-1,0

Achterwandpaneel, 1 m breed

Afmetingen: 1024x620x25 mm

Vorbereid voor 2 stopcontacten (niet meegeleverd)

8 kg

C55PTE-1,0

€ P.O.A. 1 055000319



C55/2PM

Wandpaneel met 2 hangkasten, passend in werkplaats combinaties

- 2 bovenkasten, 1024x400x300 mm, voorzien van gasveren, vereenvoudigen het openen en sluiten van de deuren.
- Wandpaneel, 2050x620 mm; kan voorzien worden van geperforeerde gereedschapsborden C55/PF (optioneel te bestellen)
- Geleverd met verstevigings balken
- Passend op een 2 meter werkbank

80 kg

C55/2PM

€ P.O.A. 1 055000301

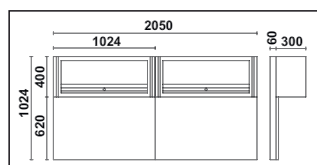
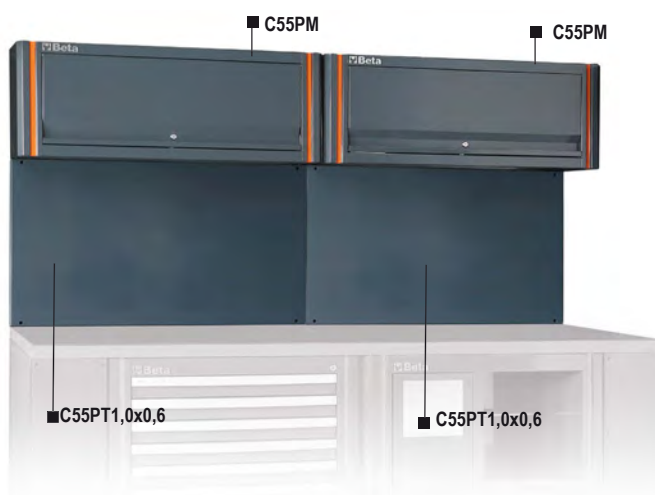

Beta

C55PFA-0,8

Zelfdragend geperforeerd paneel, 0,8 m breed, voor werkplaatsinrichting

Geperforeerd stalen gereedschapspaneel (800x1020x25 mm)

10 kg

C55PFA-0,8

€ P.O.A. 1 055000315



C55PM/M0,8

Hangkast, 0,8 m lang, voor werkplaatsinrichting

Afmetingen: 800x400x300 mm; voorzien van gasveren, vereenvoudigen het openen en het sluiten van de deur

19 kg

C55PM/M0,8

€ P.O.A. 1 055000312

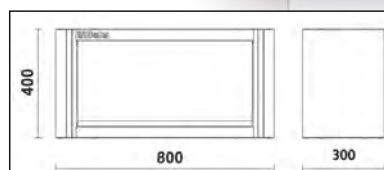

C55PTE-0,8

Achterwandpaneel, 0,8 m breed

Afmetingen: 800x620x25 mm

Vorbereid voor 1 stopcontact (niet meegeleverd)

6 kg

C55PTE-0,8

€ P.O.A. 1 055000318



C55PT0,8X0,6

Achterwandpaneel, 0,8 m breed

Afmetingen: 800x620x25 mm

7,8 kg

C55PT0,8X0,6

€ P.O.A. 1 055000313



C55/1PF

Geperforeerd gereedschapsbord voor werkplaatscombinaties

• Geperforeerd gereedschapsbord (800x600 mm)

5 kg

C55/1PF

€ P.O.A. 1 055000309

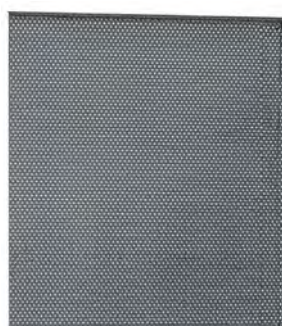

C55PS

Gereedschapswand met rolluik, passend in werkplaats combinaties

- Aluminium rolluik, verticaal instelbaar met slot
- Uitneembare geperforeerde gereedschapspanelen
- Geleverd met verstevigings balken
- 50-stuks haken (GPS kit meegeleverd)
- Passend op een 2 meter werkbank

88 kg

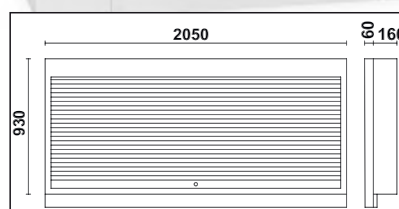

C55PS-O € P.O.A. 1 055000250
C55PS-G € P.O.A. 1 055000255

C55PSE

Gereedschapswand met rolluik
voorzien van 2 stopcontacten

- Aluminium rolluik, in hoogte instelbaar, met slot
- Uitneembare geperforeerde gereedschapspanelen
- Geleverd met bevestigingssteunen
- 50-stuks haken (GPS kit meegeleverd)
- Voorzien van stopcontacten
- Passend op 2 meter lange werkbank

88 kg

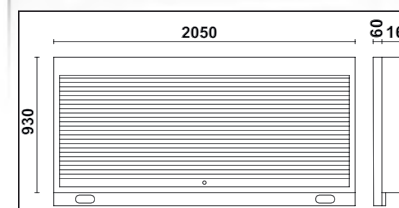

C55PSE-O € P.O.A. 1 055000258
C55PSE-G € P.O.A. 1 055000260

C55AE

Stekkerrail, 2 m lang, voor stopcontacten.

Afmetingen: 2050x25x90mm
Vorbereid voor 2 stopcontacten

1,5 kg

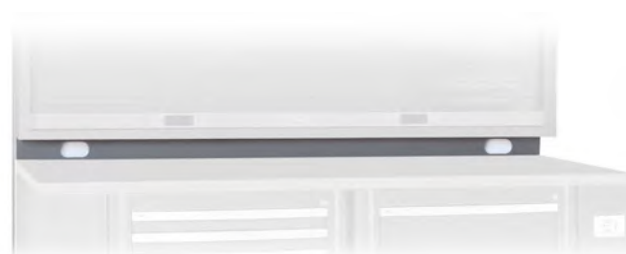

C55AE € P.O.A. 1 055000325

C55AC

Zelfdragende complete hoekmodule

Werkblad (700x700 mm) met poten
2 wandpanelen compleet met bevestigingssteunen (670x160 mm)

66 kg

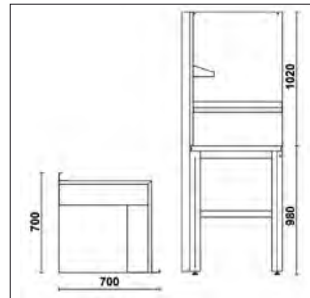

C55AC-O

C55AC-G



C55AC-O	€	1	055000360
C55AC-G	P.O.A.	1	055000380

C55KAI

Hoekblad voor werkplaatsinrichting, 700x700 gecombineerd met poten

• Gelakt stalen werkblad (700x700 mm) beschermd door een schokbestendige krasvrije PVC mat, bestand tegen koolwaterstoffen

32 kg

C55KAI-O

C55KAI-G

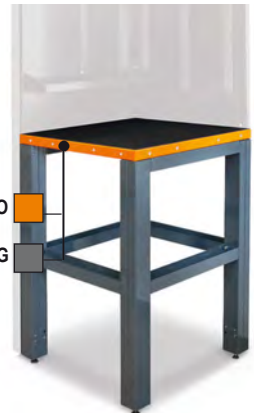

C55KAI-O	€	1	055000365
C55KAI-G	P.O.A.	1	055000385

C55KAS

Bovenste hoekdeel met gereedschapspanelen

• 2 geperforeerde gereedschapspanelen (700x1020x25 mm)
• 2 bevestigingssteunen (670x160 mm)

24 kg



C55KAS	€	1	055000370
--------	---	---	-----------

C55MP

Stalen hoekwandpanelen

Afmetingen: 700x160x80 mm



C55MP	€	1	055000374
-------	---	---	-----------

Beta

C55B/1

Verlengde werkbank, 1 m lang

Werkblad (1024x700 mm) beschermd door een schokbestendige krasvrije PVC mat, bestand tegen koolwaterstoffen

• Universele poot in hoogte verstelbaar

1 vast ladenblok:

7 laden (588x367 mm) met kogelgelagerde geleiding

• Ontsluiten van de laden over de gehele lengte door aluminium greep

• Ladenbodems beschermd door zacht rubber matten

• Centraal veiligheidsslot aan voorzijde

127 kg



h	max
70 mm	30 kg
245 mm	40 kg

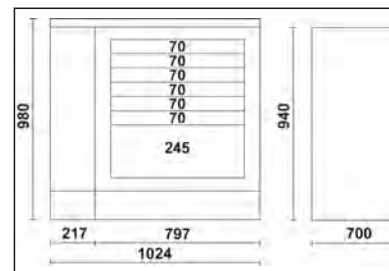
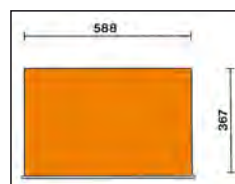

C55BO/1
C55BG/1

€ 1
P.O.A. 1 055000090
P.O.A. 1 055000091

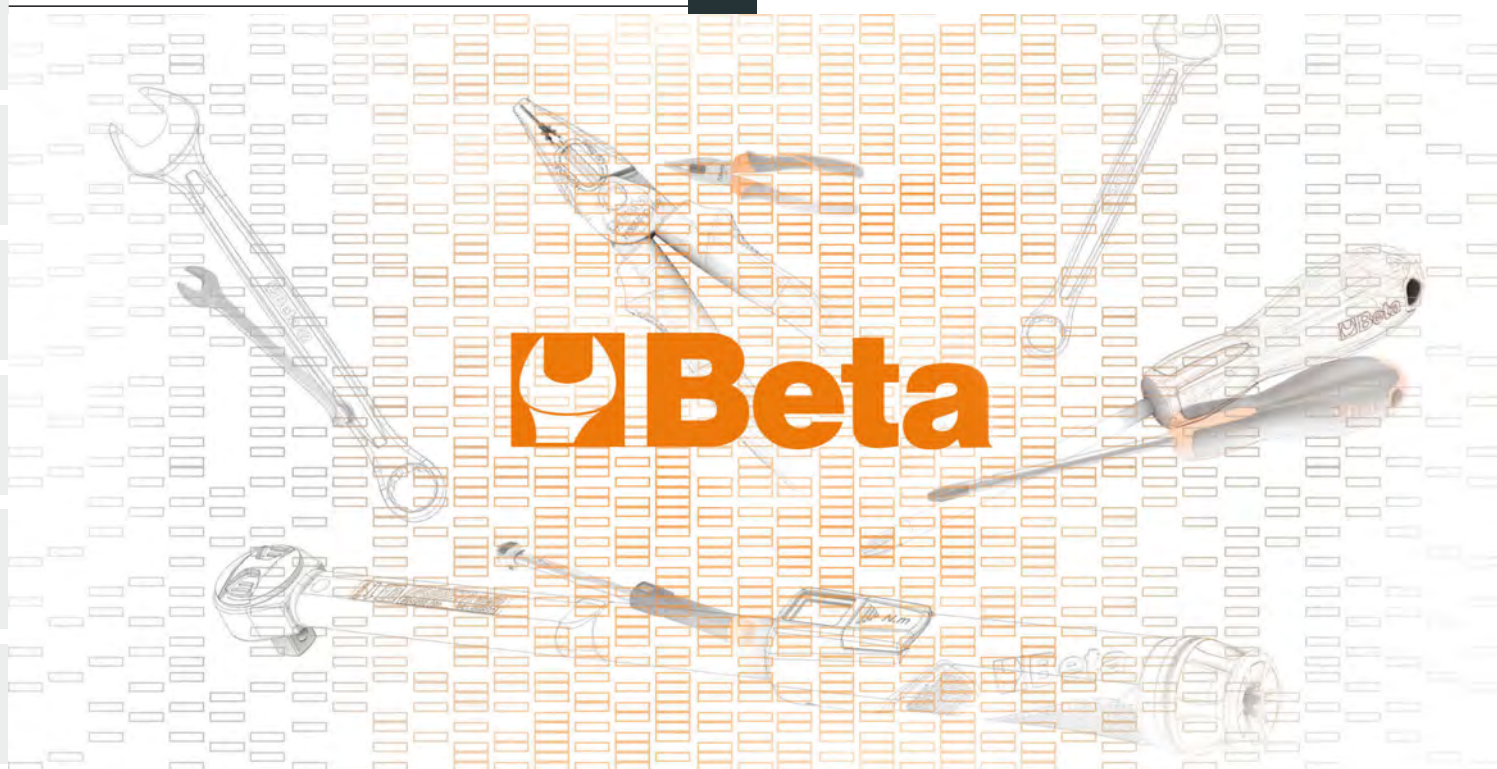

C55A1

Plaatstalen enkele deurskast, voor werkplaatsinrichting

- 3 uitneembare, verticaal verstelbare planken
- handig opklapbaar kledingrek onder eerste plank
- met slot
- bruikbare binnenafmetingen: 1770x420x420 mm

50 kg

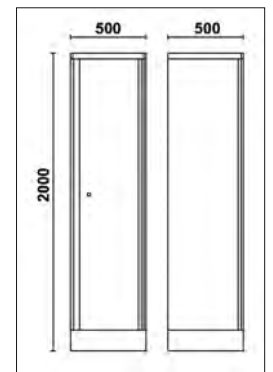

C55A1

€ P.O.A. 1 055000411

C55A1/R42

Binnenplank voor gereedschapskast C55A1/C55AT1

2,4 kg



C55A1/R42

497x403 mm

€ P.O.A. 1 055000461

C55 A1/RB42

binnenplank voor gereedschapskast C55A1/C55AT1, met kledingrek

2,5 kg

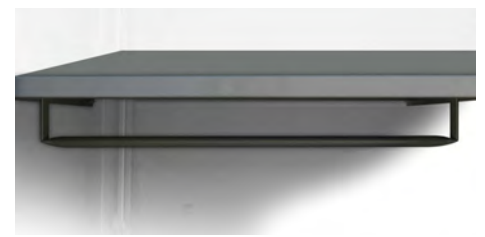

C55 A1/RB42

497x403 mm

€ P.O.A. 1 055000463

Beta

C55A2

Plaatstalen dubbele deurskast, als deel van een werkplaatsinrichting

- 3 uitneembare en verticaal verstelbare legplanken
- Met veiligheidsslot
- Bruikbare afmetingen: 1798x797x403 mm

72 kg

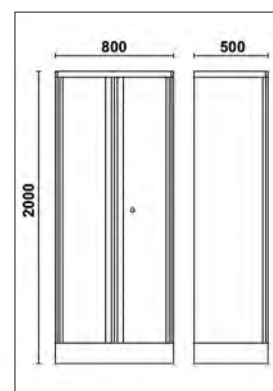

C55A2

€ P.O.A. 1 055000412

C55A2/R70

Binnenplank voor gereedschapskast C55A2/C55AT2

3,5 kg



C55A2/R70

700x420 mm

€ P.O.A. 1 055000462

Beta

C55AT1

laatstalen kast met een enkele doorzichtige polycarbonaat deur, als deel voor een werkplaatsinrichting

- 3 uitneembare en verticaal verstelbare legplanken
- Met veiligheidsslot
- Bruikbare binnen afmetingen: 1798x497x403 mm

41 kg

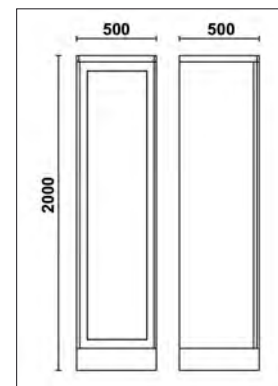

C55AT1 € P.O.A. 1 055000421

C55AT2

Plaatstalen kast met dubbele doorzichtige polycarbonaat deuren, als deel voor een werkplaatsinrichting

- 3 uitneembare en verticaal verstelbare legplanken
- Met veiligheidsslot
- Bruikbare binnen afmetingen: 1798x797x403 mm

56 kg

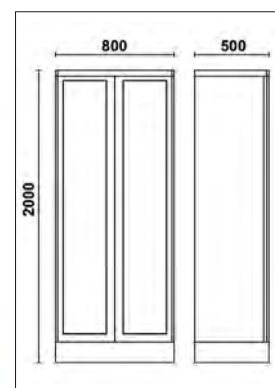

C55AT2 € P.O.A. 1 055000422

C55STR

Klevend gekleurde tape 25 m

Maakt het mogelijk uw eigen kleur te kiezen op de verticale zijde van de C55 series



RAL2011
RAL3000
RAL6029
RAL9016
RAL1023
RAL5015
RAL1035
RAL9006

	€	P.O.A.	1	055000901
C55STR-O/2011	Orange	P.O.A.	1	055000901
C55STR-R/3000	Red	P.O.A.	1	055000903
C55STR-V/6029	Green	P.O.A.	1	055000906
C55STR-W/9016	White	P.O.A.	1	055000907
C55STR-Y/1023	Yellow	P.O.A.	1	055000905
C55STR-B/5015	Blue	P.O.A.	1	055000904
C55STR-GO/1035	Brown	P.O.A.	1	055000909
C55STR-S/9006	Grey	P.O.A.	1	055000902





WERKPLAATSINRICHTING



Beta blijft investeren in productie van Italiaanse makelij en introduceert met trots

DE NIEUWE REEKS WERKPLAATSINRICHTING

Op basis van de expertise die is opgedaan met de twee bestaande reeksen werkplaatsinrichting, RSC55 en C45PRO, hebben we de eisen en wensen van professionele gebruikers volledig uitgewerkt en deze kunnen integreren in het project voor de nieuwe reeks, de RSC50, op de volgende cruciale punten:

KWALITEIT

Onze veel geprezen zorg bij het kiezen van de materialen, nauwgezette aandacht voor detail en, last but not least, het boeiende ontwerp maken de RSC50 tot een uniek assortiment werkplaatsinrichting.



Flexibiliteit

Elke combinatie is modulair en kan op elk moment naar behoefte worden uitgebreid of gewijzigd.

Compatibiliteit

De laden in de standaardafmetingen van Beta (588x367 mm) bieden plaats aan de talrijke gereedschapsmodules, die verkrijgbaar zijn in zowel zachte als harde versies, respectievelijk gemaakt van EVA-Foam en ABS



Efficiëntie

Eenvoudige en snelle installatie, gebaseerd op de geoptimaliseerde productie van de verschillende onderdelen van het assortiment.

Functionaliteit en Stevigheid

Met het 63 cm diepe werkblad heb je een groot, handig en functioneel werkoppervlak tot je beschikking. Hij kan worden voorzien van een bankschroef, waardoor zware klussen kunnen worden uitgevoerd.



MADE IN ITALY

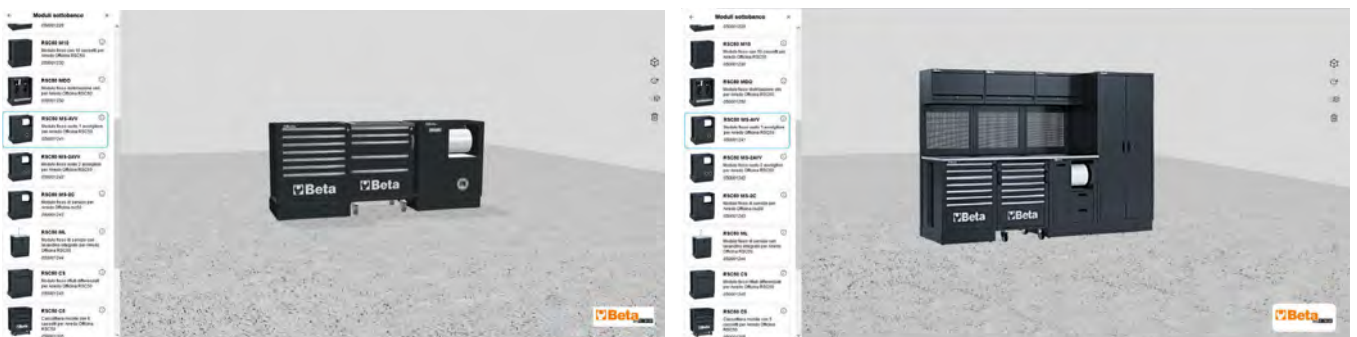

Configureer uw werkplaats in 3D online
op **www.beta-tools.com**

De nieuwe serie werkplaatsuitrusting, RSC50, bestaat uit standaard combinaties, ontwikkeld door Beta voor professionals; als alternatief kunt u uw werkplek geheel zelf inrichten, waarbij u kunt kiezen uit vele modules, wandkasten en accessoires.

De aangepaste kleuren van de ladegrepen en verlichting onder de werkbladen en wandkasten resulteren in een unieke werkplaatsinrichting, waardoor de RSC50 een ideale keuze is voor diegenen die prioriteit geven aan werken in een functionele, efficiënte omgeving.



RSC50 I

Werkplaatsinrichting RSC50

Combinatie bestaande uit:

- 1 2.240 mm lang werkblad (RSC50 PG/3-2,2MT)
- 1 1.495 mm lang werk (RSC50 PG/2-1,5MT)
- 1 vaste module met 7 laden (RSC50 M7)
- 1 gereedschapswagen met 7 laden (RSC50 C7)
- 1 vaste servicemodule met 2 laden (RSC50 MS-2C)
- 1 zelfdragende complete hoek (RSC50 AC-G)
- 1 vaste module met 5 laden (RSC50 M5)
- 1 vaste tweedeursmodule (RSC50 MA)
- 5 wandkasten (RSC50 PM)
- 5 bovenste geperforeerde gereedschapspanelen (RSC50 PFS)
- 5 onderste geperforeerde gereedschapspanelen (RSC50 PFI)
- 5 paar rechter/linker steunpalen (RSC50 P/2MDX-SX)
- 2 enkeledeurs hoge kast (RSC50 A1)

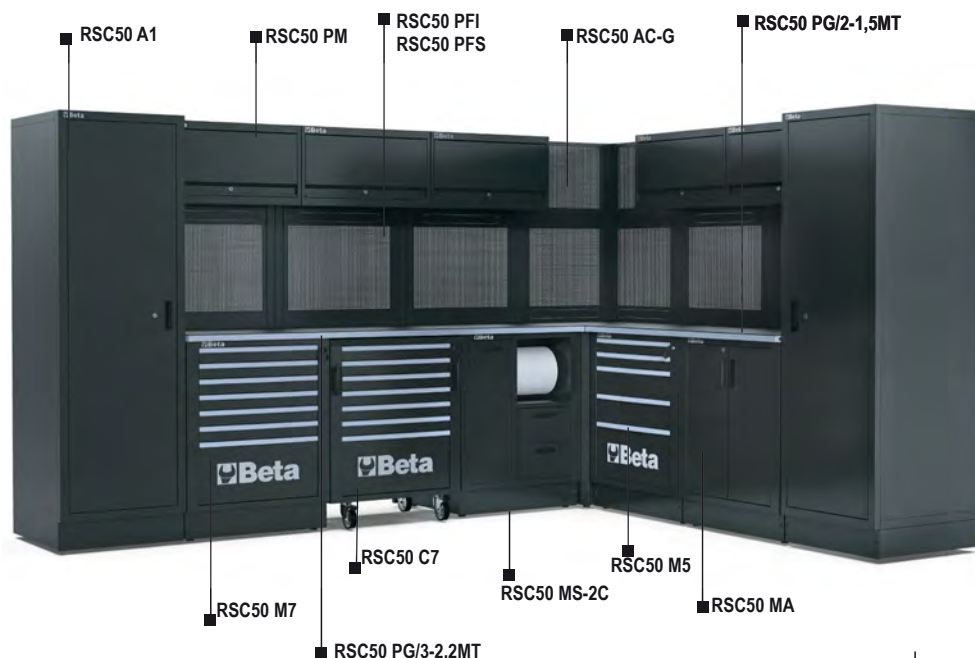

2000
690
3530 / 2785

625 kg

RSC50 I

€ P.O.A. 1 050001045

RSC50 L

Werkplaatsinrichting RSC50

Combinatie bestaande uit:

- 1 2.240 mm lang werkblad (RSC50 PG/3-2,2MT)
- 1 1750 mm lang werkblad (RSC50 PG/1-0,7MT)
- 1 vaste servicemodule (RSC50 MS-2AVV) met luchthaspel item 1900s 8x10 en stroomhaspel item 1844 15-H05/SCK (inbegrepen)
- 1 gereedschapswagen met 7 laden (RSC50 C7)
- 1 vaste module met 7 laden (RSC50 M7)
- 1 zelfdragende complete hoek (RSC50 AC)
- 1 vaste tweedeursmodule (RSC50 MA)
- 1 gereedschapswand met aluminium jaloezieën en zelfdragend frame (RSC50 PS)
- 2 wandkasten (RSC50 PM)
- 2 bovenste geperforeerde gereedschapspanelen (RSC50 PFS)
- 2 onderste geperforeerde gereedschapspanelen (RSC50 PFI)
- 2 paar rechter/linker steunpalen (RSC50 P/2MDX-SX)
- 2 enkeledeurs hoge kasten (RSC50 A1)

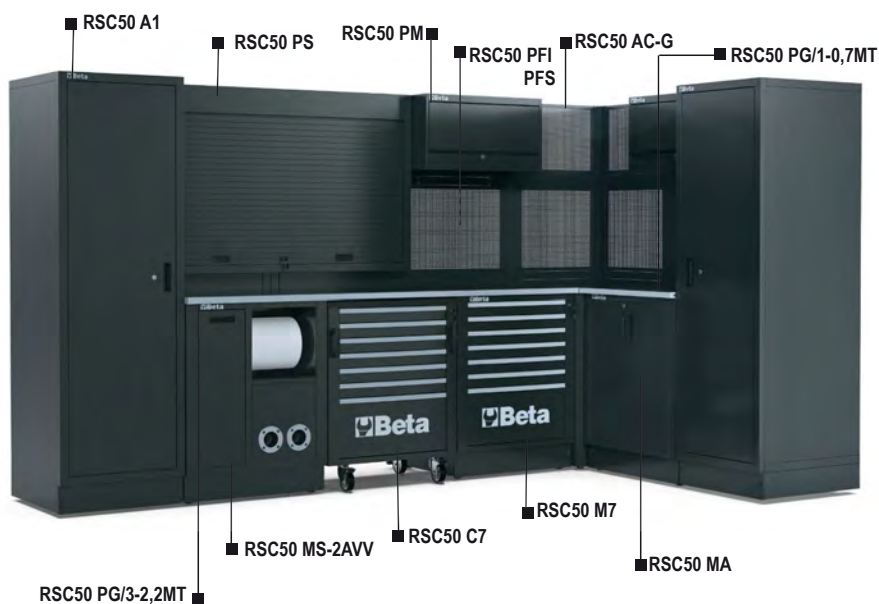

2000
690
3530 / 2040

541 kg

RSC50 L

€ P.O.A. 1 050001050

RSC50

Uitgebreide combinatie van werkplaatsinrichting RSC50

Uitgebreide combinatie bestaande uit:

- 1 Enkeldeurs gereedschapskast (RSC50 A1)
- 1 750 mm lang werkblad (RSC50 PG/1-0,7MT)
- 1 2.240 mm lang werkblad (RSC50 PG/3-2,2MT)
- 1 gereedschapswagen met 7 laden (RSC50 C7)
- 1 vaste module met 4 laden (RSC50 M4)
- 1 vaste module met 7 laden (RSC50 M7)
- 1 vaste Service Module (RSC50 MS-AVV) met luchthaspel Item 1900S 8x10 (inbegrepen)
- 1 gereedschapswandsysteem met aluminium jaloezieën en zelfdragend frame (RSC50 PS)
- 2 wandkasten (RSC50 PM)
- 2 bovenste geperforeerde gereedschapspanelen (RSC50 PFS)
- 2 onderste geperforeerde gereedschapspanelen (RSC50 PFI)
- 2 paar rechter/linker steunpalen (RSC50 P/2MDX-SX)
- 1 tweedeurs gereedschapskast (RSC50 A2)

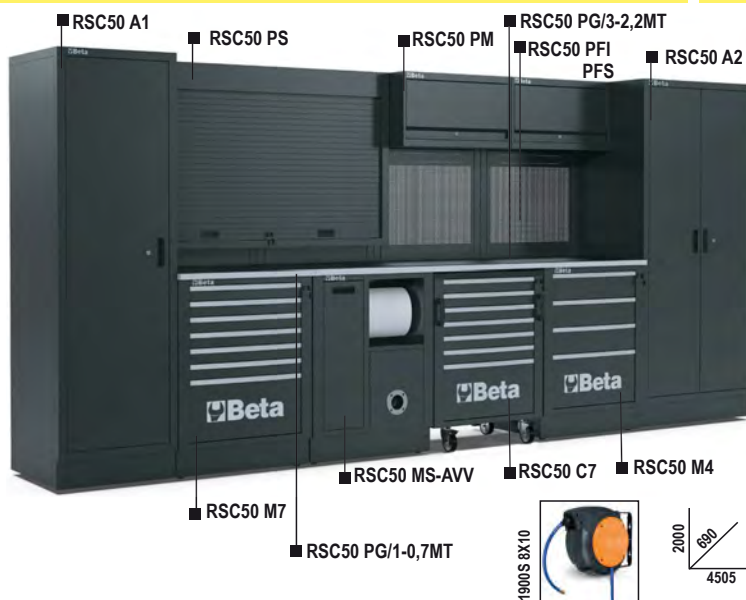

534 kg

RSC50

€ P.O.A. 1 050001000

RSC50 H

Werkplaatsinrichting RSC50

Combinatie bestaande uit:

- 1 2.240 mm lang werkblad (RSC50 PG/3-2,2MT)
- 1 vaste servicemodule met 2 laden (RSC50 MS-2C)
- 1 gereedschapswagen met 7 laden (RSC50 C7)
- 1 vaste module met 7 laden (RSC50 M7)
- 1 vaste module met ingebouwde gootsteen (RSC50 ML)
- 4 wandkasten (RSC50 PM)
- 4 bovenste geperforeerde gereedschapspanelen (RSC50 PFS)
- 4 onderste geperforeerde gereedschapspanelen (RSC50 PFI)
- 4 paar rechter/linker steunen (RSC50 P/2MDX-SX)
- 1 enkele deur gereedschapskast (RSC50 A1)

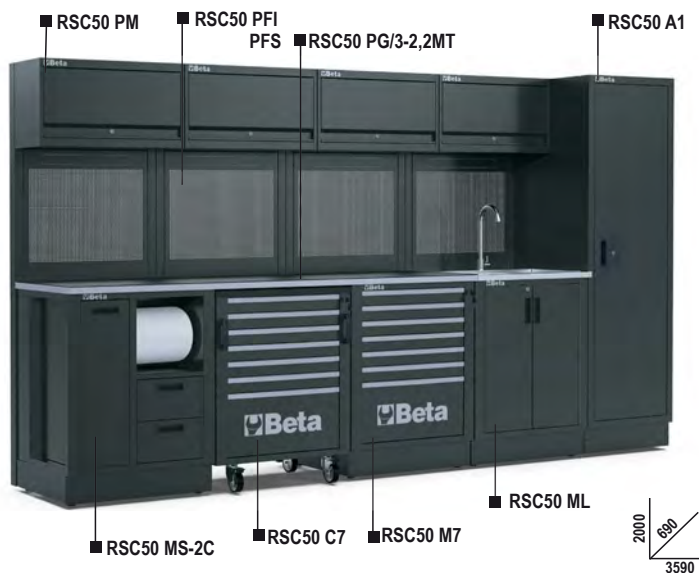

417 kg

RSC50 H

€ P.O.A. 1 050001040

RSC50 G

Werkplaatsinrichting RSC50

Combinatie bestaande uit:

- 1 2.240 mm lang werkblad (RSC50 PG/3-2,2MT)
- 1 vaste servicemodule (RSC50 MS-2AVV) met luchthaspel item 1900s 8x10 en stroomhaspel item 1844 15-H05/SCK (inbegrepen)
- 1 gereedschapswagen met 7 laden (RSC50 C7)
- 1 vaste module met 4 laden (RSC50 M4)
- 3 wandkasten (RSC50 PM)
- 3 bovenste geperforeerde gereedschapspanelen (RSC50 PFS)
- 3 onderste geperforeerde gereedschapspanelen (RSC50 PFI)
- 3 paar rechter/linker steunen (RSC50 P/2MDX-SX)
- 1 dubbel-deurs gereedschapskast (RSC50 A2)

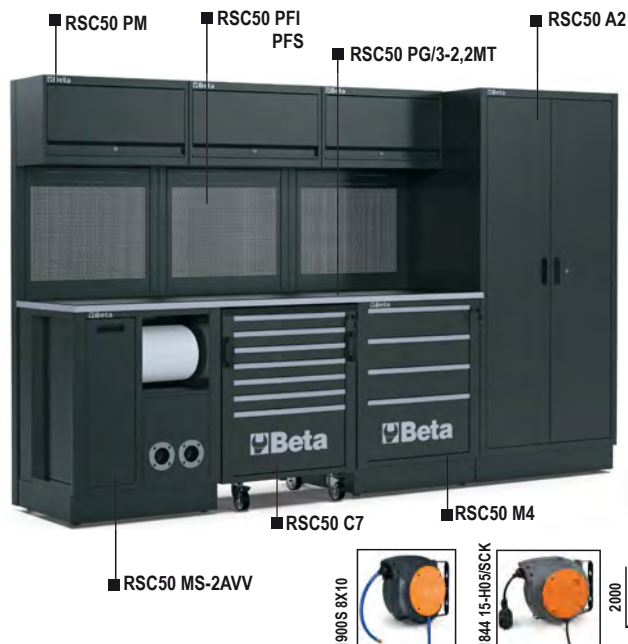

356 kg

RSC50 G

€ P.O.A. 1 050001035

RSC50 F

Werkplaatsinrichting RSC50

Combinatie bestaande uit:

- 1 2240 mm lang werkblad (RSC50 PG/3-2,2MT)
- 1 vaste module met 7 laden (RSC50 M7)
- 1 mobiele rolcabine met 7 laden (RSC50 C7)
- 1 vaste servicemodule met 2 laden (RSC50 MS-2C)
- 3 wandkasten (RSC50 PM)
- 3 bovenste geperforeerde gereedschapspanelen (RSC50 PFS)
- 3 onderste geperforeerde gereedschapspanelen (RSC50 PFI)
- 3 paar rechter/linker steunen (RSC50 P/2MDX-SX)
- 1 dubbel-deurs gereedschapskast (RSC50 A2)

361 kg

RSC50 F

€ P.O.A. 1 050001030



RSC50 E

Werkplaatsinrichting RSC50

Combinatie bestaande uit:

- 1 2.240 mm lang werkblad (RSC50 PG/3-2,2MT)
- 1 vaste servicemodule met 2 laden (RSC50 MS-2C)
- 1 vaste module met 7 laden (RSC50 M7)
- 1 vaste tweedeursmodule (RSC50 MA)
- 3 wandkasten (RSC50 PM)
- 3 bovenste geperforeerde gereedschapspanelen (RSC50 PFS)
- 3 onderste geperforeerde gereedschapspanelen (RSC50 PFI)
- 3 paar rechter/linker steunen (RSC50 P/2MDX-SX)

266 kg

RSC50 E

€ P.O.A. 1 050001025

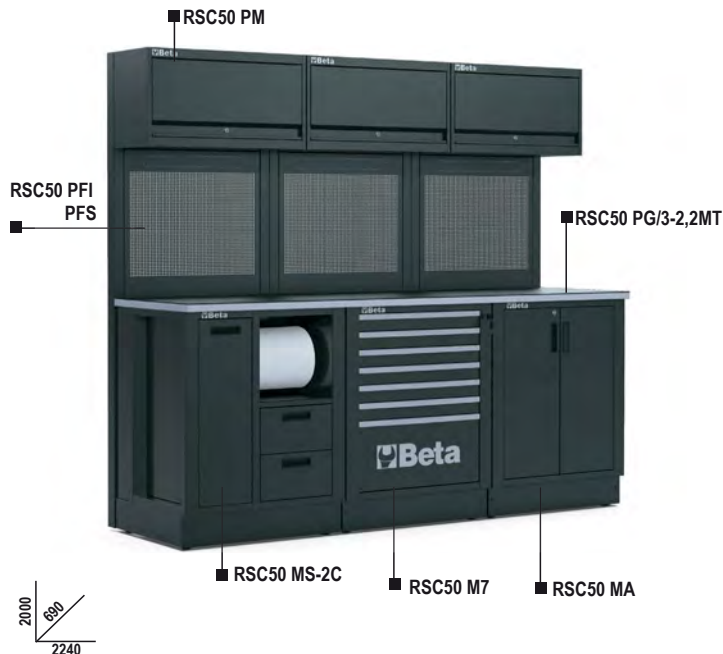

RSC50 D

Werkplaatsinrichting RSC50

Combinatie bestaande uit:

- 1 1.495 mm lang werkblad (RSC50 PG/2-1,5MT)
- 1 vaste module met 5 laden (RSC50 M5)
- 1 vaste tweedeursmodule (RSC50 MA)
- 2 wandkasten (RSC50 PM)
- 2 bovenste geperforeerde gereedschapspanelen (RSC50 PFS)
- 2 onderste geperforeerde gereedschapspanelen (RSC50 PFI)
- 2 paar rechter/linker steunpalen (RSC50 P/2MDX-SX)
- 1 Enkeldeurs gereedschapskast (RSC50 A1)

230 kg

RSC50 D

€ P.O.A. 1 050001020

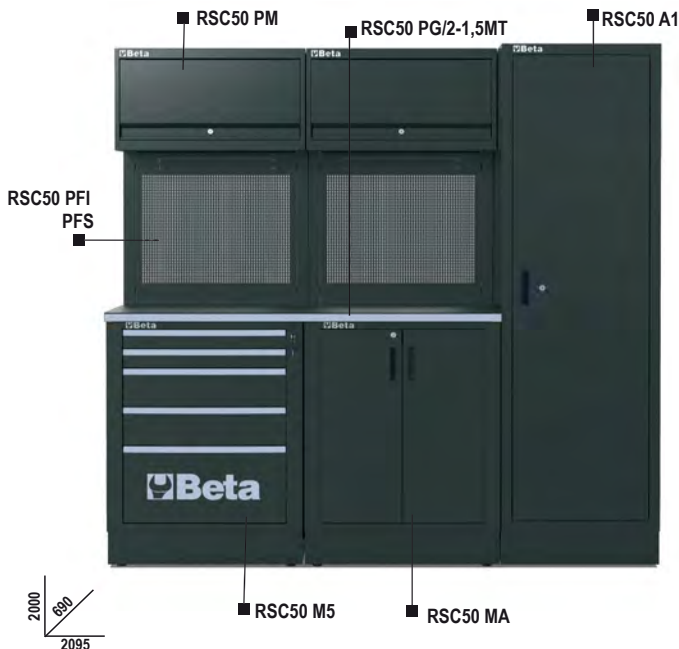

RSC50 C

werkplaatsinrichting RSC50

Combinatie bestaande uit:

- 1 1.495 mm lang werkblad (RSC50 PG/2-1,5MT)
- 1 vaste servicemodule met 2 laden (RSC50 MS-2C)
- 1 vaste module met 7 laden (RSC50 M7)
- 2 Wandkasten (RSC50 PM)
- 2 bovenste geperforeerde gereedschapspanelen (RSC50 PFS)
- 2 onderste geperforeerde gereedschapspanelen (RSC50 PFI)
- 2 paar rechter/linker steunpalen (RSC50 P/2MDX-SX)
- 1 enkeleurs gereedschapskast (RSC50 A1)

258 kg

RSC50 C

€ P.O.A. 1 050001015

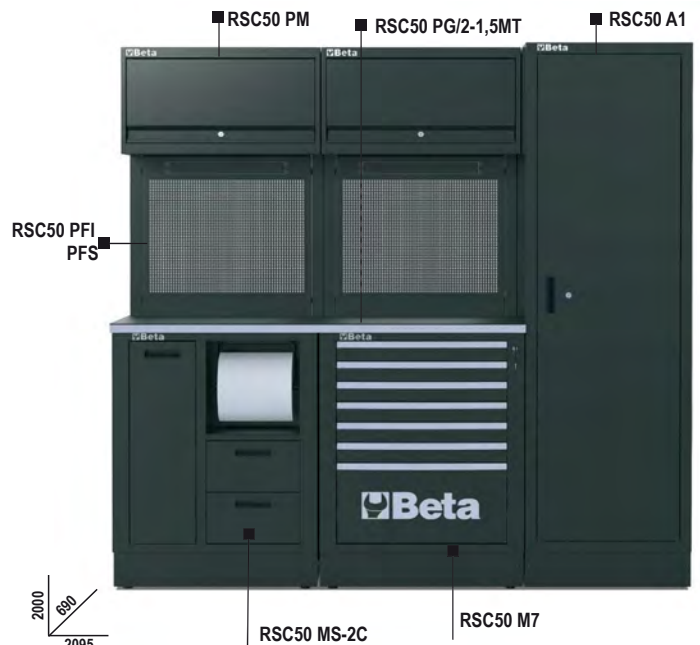

RSC50 B

werkplaatsinrichting RSC50

Combinatie bestaande uit:

- 1 1.495 mm lang werkblad (RSC50 PG/2-1,5MT)
- 1 vaste tweedeursmodule (RSC50 MA)
- 1 vaste module met 7 laden (RSC50 M7)
- 1 gereedschapswand met aluminium rolluik en zelf-dragend frame (RSC50 PS)

188 kg

RSC50 B

€ P.O.A. 1 050001010



RSC50 A

Werkplaatsinrichting RSC50

Combinatie bestaande uit:

- 1 1.495 mm lang werkblad (RSC50 PG/2-1,5MT)
- 1 vaste module met 7 laden (RSC50 M7)
- 1 vaste servicemodule met 2 laden (RSC50 MS-2C)
- 2 wandkasten (RSC50 PM)
- 2 bovenste geperforeerde gereedschapspanelen (RSC50 PFS)
- 2 onderste geperforeerde gereedschapspanelen (RSC50 PFI)
- 2 paar rechter/linker steunpalen (RSC50 P/2MDX-SX)

192 kg

RSC50 A

€ P.O.A. 1 050001005

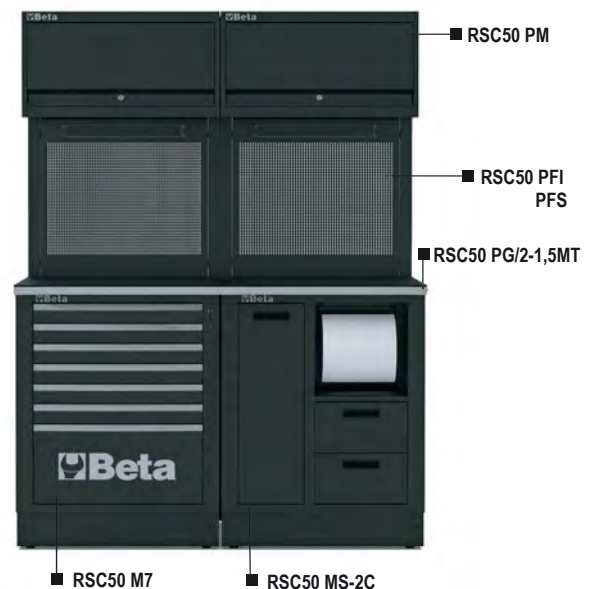

RSC50 P/1-0,7MT

0,75 m lang werkblad, voor werkplaatsinrichting RSC50

Gepoedercoat stalen werkblad, 750x630 mm, voorzien van een schokbestendige, krasvrije PVC-coating, bestand tegen koolwaterstoffen.

Geleverd compleet met zijsteunen.

Gaten voor een bankschroef (1599P/125, optioneel) aan beide kanten.

Ontworpen voor toepassing van aluminium profielen met LED-strips item 5000 RSC50/PLED of 5000 RSC50/PLED-ST (apart te bestellen) om uw modules te voorzien van licht.

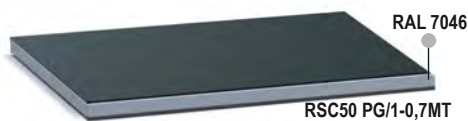

12,4 kg

RSC50 PG/1-0,7MT	€	1	050001107
RSC50 PA/1-0,7MT	P.O.A.	1	050001108

RSC50 P/2-1,5MT

1,5 m lang werkblad, voor werkplaatsinrichting RSC50

Gepoedercoat stalen werkblad, 1.495x630 mm, voorzien van een schokbestendige, krasvrije PVC-coating, bestand tegen koolwaterstoffen.

Geleverd compleet met zijsteunen.

Gaten voor een bankschroef (1599P/125, optioneel) aan beide kanten.

Ontworpen voor toepassing van aluminium profielen met LED-strips item 5000 RSC50/PLED of 5000 RSC50/PLED-ST (apart te bestellen) om uw modules te voorzien van licht.

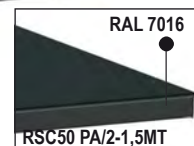

24,5 kg

RSC50 PG/2-1,4MT	€	1	050001114
RSC50 PA/2-1,4MT	P.O.A.	1	050001115

RSC50 P/3-2,2MT

2,2 m lang werkblad, voor werkplaatsinrichting RSC50

Gepoedercoat stalen werkblad, 2.240x630 mm, voorzien van een schokbestendige, krasvrije PVC-coating, bestand tegen koolwaterstoffen.

Geleverd compleet met zijsteunen.

Gaten voor een bankschroef (1599P/125, optioneel) aan beide kanten.

Ontworpen voor toepassing van aluminium profielen met LED-strips item 5000 RSC50/PLED of 5000 RSC50/PLED-ST (apart te bestellen) om uw modules te voorzien van licht.

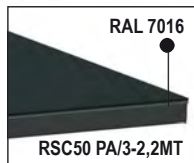

36,5 kg

RSC50 PG/3-2,2MT	€	1	050001122
RSC50 PA/3-2,2MT	P.O.A.	1	050001123



RSC50 RB

schokbestendige, krasvrije PVC-coating, bestand tegen koolwaterstoffen.

Een must-have voor het beschermen van werkbladen.

RSC50 RB/0,63: voor hoekwerkblad, 630x630 mm

RSC50 RB/0,75: voor 750 mm lang werkblad

RSC50 RB/1,5: voor 1.495 mm lang werkblad

RSC50 RB/2,2: voor 2.240 mm lang werkblad



	€		
RSC50 RB/0,63	P.O.A.	1	050001140
RSC50 RB/0,75	P.O.A.	1	050001141
RSC50 RB/1,5	P.O.A.	1	050001142
RSC50 RB/2,2	P.O.A.	1	050001143

RSC50 C5

Gereedschapswagen met 5 laden, voor werkplaatsinrichting RSC50

- 5 laden (588x367 mm) met kogellagers
- 4 stuurwielen, Ø 100 mm (2 met rem)
- Ladenbodems beschermd door rubberen matten
- Centraal slot aan voorzijde
- Kan worden uitgerust met standaard inlays
- Handgrepen geïntegreerd in frame voor een verbeterd bedieningsgemak
- Iedere lade biedt plaats aan maximaal 4 thermisch gevormde modules EVA-foam of ABS

51,4 kg

h		max
70 mm		25 kg
140 mm		30 kg
280 mm		35 kg

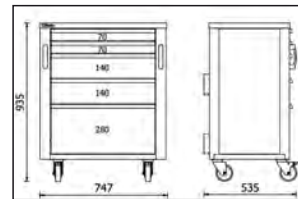
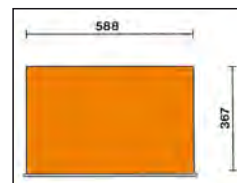

800 kg



	€		
RSC50 C5	P.O.A.	1	050001205

RSC50 C7

Gereedschapswagen met 7 laden, voor werkplaatsinrichting RSC50

- 7 laden (588x367 mm) met kogellagers
- 4 stuurwielen, Ø 100 mm (2 met rem)
- Ladenbodems beschermd door rubberen matten
- Centraal slot aan voorzijde
- Kan worden uitgerust met standaard inlays
- Handgrepen geïntegreerd in frame voor een verbeterd bedieningsgemak
- Iedere lade biedt plaats aan maximaal 4 thermisch gevormde modules EVA-foam of ABS

56,3 kg

h		max
70 mm		25 kg
280 mm		35 kg

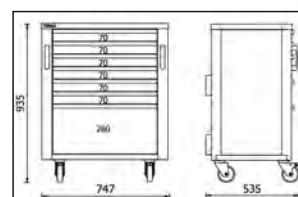
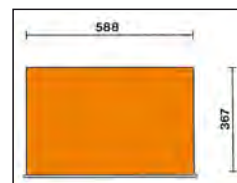

800 kg



	€		
RSC50 C7	P.O.A.	1	050001207

RSC50 C8

Gereedschapswagen met 8 laden, voor werkplaatsinrichting RSC50

- 8 laden (588x367 mm) met kogellagers
- 4 stuurwielen, Ø 100 mm (2 met rem)
- Ladenbodems beschermd door rubberen matten
- Centraal slot aan voorzijde
- Kan worden uitgerust met standaard inlays
- Handgrepen geïntegreerd in frame voor een verbeterd bedieningsgemak
- Iedere lade biedt plaats aan maximaal 4 thermisch gevormde modules EVA-foam of ABS

59 kg

h	max
70 mm	25 kg
140 mm	30 kg

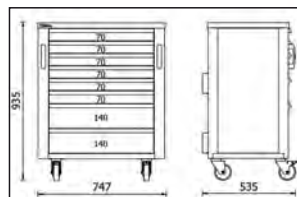
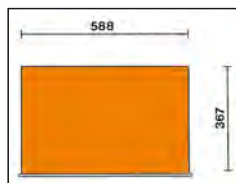

800 kg



RSC50 C8

€ P.O.A. 1 050001208

RSC50 M4

Vaste module met 4 laden, voor werkplaatsinrichting RSC50

- 4 laden (588x367 mm) met kogellager geleiding
- Ladenbodems beschermd door rubberen matten
- Centraal slot
- Met verticaal verstelbare pootjes
- Iedere lade biedt plaats aan maximaal 4 thermisch gevormde modules EVA-foam of ABS

44,5 kg

h	max
140 mm	30 kg
280 mm	35 kg

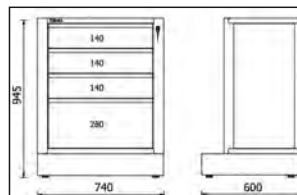
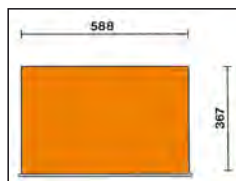

RSC50 M4

€ P.O.A. 1 050001224

RSC50 M5

Vaste module met 5 laden, voor werkplaatsinrichting RSC50

- 5 laden (588x367 mm) met kogellager geleiding
- Ladenbodems beschermd door rubberen matten
- Centraal slot
- Met verticaal verstelbare pootjes
- Iedere lade biedt plaats aan maximaal 4 thermisch gevormde modules EVA-foam of ABS

47 kg

h	max
70 mm	25 kg
140 mm	30 kg
280 mm	35 kg

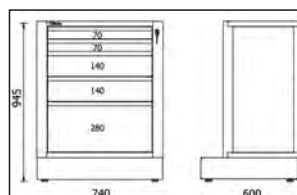
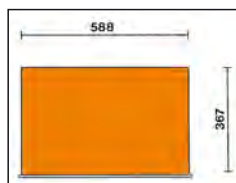



RSC50 M5

€ P.O.A. 1 050001225

RSC50 M7

Vaste module met 7 laden, voor werkplaatsinrichting RSC50

- 7 laden (588x367 mm) met kogellager geleiding
- Ladenbodems beschermd door rubberen matten
- Centraal slot
- Met verticaal verstelbare pootjes
- Iedere lade biedt plaats aan maximaal 4 thermisch gevormde modules EVA-foam of ABS

 h	 max
70 mm	25 kg
280 mm	35 kg

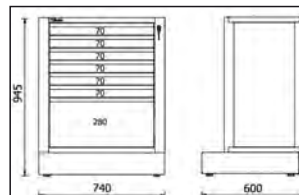
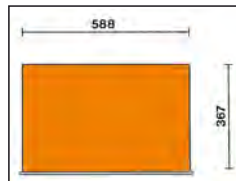

52 kg

RSC50 M7

€ P.O.A. 1 050001227

RSC50 M8

Vaste module met 8 laden, voor werkplaatsinrichting RSC50

- 8 laden (588x367 mm) met kogellager geleiding
- Ladenbodems beschermd door rubberen matten
- Centraal slot
- Met verticaal verstelbare pootjes
- Iedere lade biedt plaats aan maximaal 4 thermisch gevormde modules EVA-foam of ABS

 h	 max
70 mm	25 kg
140 mm	30 kg

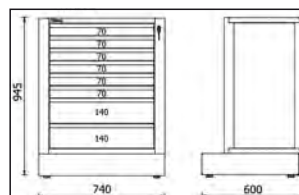
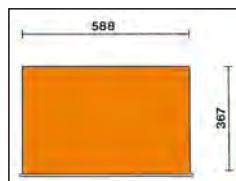

53,2 kg



RSC50 M8

€ P.O.A. 1 050001228

RSC50 M10

Vaste module met 10 laden, voor werkplaatsinrichting RSC50

- 10 laden (588x367 mm) met kogellager geleiding
- Ladenbodems beschermd door rubberen matten
- Centraal slot
- Met verticaal verstelbare pootjes
- Iedere lade biedt plaats aan maximaal 4 thermisch gevormde modules EVA-foam of ABS

 h	 max
70 mm	25 kg

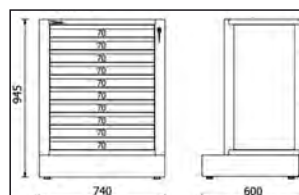
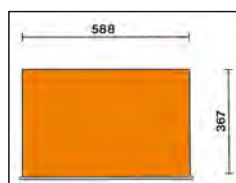

58,2 kg

RSC50 M10

€ P.O.A. 1 050001230

RSC50 MS-2C

Vaste servicemodule, voor werkplaatsinrichting RSC50

- Ingebouwde afvalbak
- Papierrol compartiment
- Twee laden, 310x370 mm, 180 mm hoog
- met verticaal verstelbare pootjes

57 kg

RSC50 MS-2C

€ P.O.A. 1 050001243

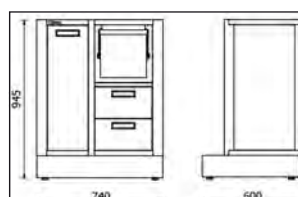

RSC50 MS-AVV

Vaste servicemodule, voor werkplaatsinrichting RSC50, leeg

Geschikt voor twee haspels, te kiezen uit de volgende modellen:

- Luchthaspel item 1900s 8x10
- Stroomkabels items 1843 15-H05, 1844 10-H05, 1844 15-H05, 1844 15-H07, 1844 15-H05/SCK, 1844 15-H07/SCK, 1845 12-H05, 1846 10-H05, 1846 10-H07 en 1846 15-H05

- Ingebouwde afvalbak
- Papierrol compartiment
- met verticaal verstelbare pootjes

41,5 kg

RSC50 MS-AVV

€ P.O.A. 1 050001241

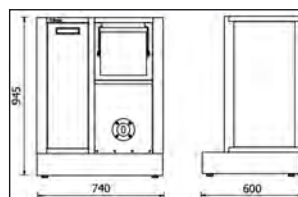

RSC50 MS-2AVV

Vaste servicemodule, voor werkplaatsinrichting RSC50, leeg

Geschikt voor twee haspels, te kiezen uit de volgende modellen:

- Luchthaspels item 1900s 8x10
- Stroomhaspels items 1843 15-H05, 1844 10-H05, 1844 15-H05, 1844 15-H07, 1844 15-H05/SCK, 1844 15-H07/SCK, 1845 12-H05, 1846 10-H05, 1846 10-H07 en 1846 15-H05

- Ingebouwde afvalbak
- Papierrolcompartiment
- met verticaal verstelbare pootjes

41,7 kg

RSC50 MS-2AVV

€ P.O.A. 1 050001242

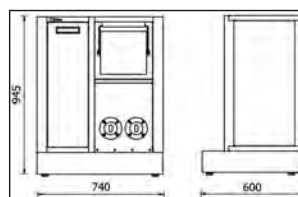

RSC50 MA

Vaste tweedeursmodule, voor werkplaatsinrichting RSC50

- met slot
- verticaal verstelbare binnenplank
- Binnen afmetingen: 615x435x740 mm
- met verticaal verstelbare pootjes

34 kg

RSC50 MA

€ P.O.A. 1 050001222

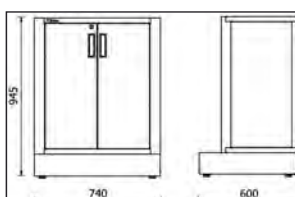

RSC50 CS

Vaste afvalverzamelingsmodule, voor werkplaatsinrichting RSC50

- Uittrekbaar compartiment voor afval (588x355x580 mm) met kogellagers
- 2 ruime uitneembare bakken voor het scheiden van afval

36 kg

RSC50 CS

€ P.O.A. 1 050001245

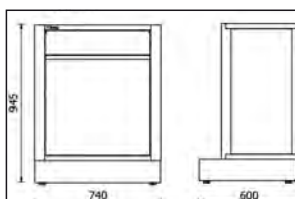

RSC50 ML

Vaste module met ingebouwde spoelbak, voor werkplaatsinrichting RSC50

Technische specificaties:

- Roestvaststalen spoelbak
- Wordt geleverd compleet met:
 - 1 kraan (warm/koud)
 - 1 afvoer
 - 1 gootsteen stopper
 - 1 filterdop
 - 1 zeep dispenser

Vaste tweedeursmodule met slot:

- Inwendige interieurafmetingen: 615x435x575 mm
- met verticaal verstelbare pootjes

33,5 kg

RSC50 ML

€ P.O.A. 1 050001244

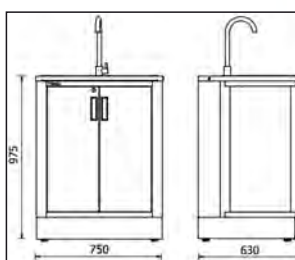

RSC50 MDO

Vaste module voor olie afgifte, voor werkplaatsinrichting RSC50

- 2 haspels met 7m - 1/2 "slang inbegrepen
- Compleet met 2 pistolen met digitale liter-teller en automatische druppelvanger.
- Max. afgifte: 30 l/min
- Viscositeit: 8 ÷ 2000 mPas
- Met verticaal verstelbare pootjes

📦 74 kg

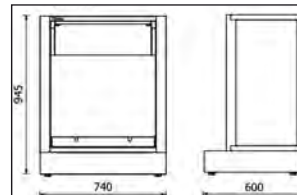

RSC50 MDO

€  1  050001250

RSC50 T3

Trolley/gereedschapswagen met 3 plateaus, voor werkplaatsinrichting RSC50

- 4 draaibare wielen, Ø 100 mm (2 met rem)
- Statische belasting: 200 kg (verdeeld over 3 planken)

📦 22,3 kg

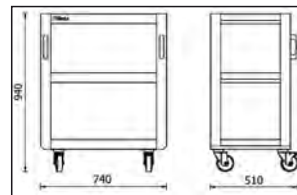

RSC50 T3

€  1  050001253



Beta

RSC50 KPF

set van geperforeerde gereedschapspanelen, voor werkplaatsinrichting RSC50

- 1 bovenste geperforeerd gereedschapspaneel, 650x400x25 mm
- 1 onderste geperforeerd gereedschapspaneel, 650x625x25 mm, is geschikt voor een 19" rack multi-socket (niet inbegrepen)
- Een paar steunpalen rechts/links



14,8 kg

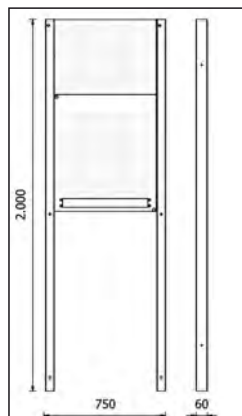

RSC50 KPF

€ P.O.A. 1 050001310

RSC50 PFS

geperforeerd gereedschapspaneel, bovenste deel, voor werkplaatsinrichting RSC50

- Afmetingen: 650x400x25 mm

2,5 kg

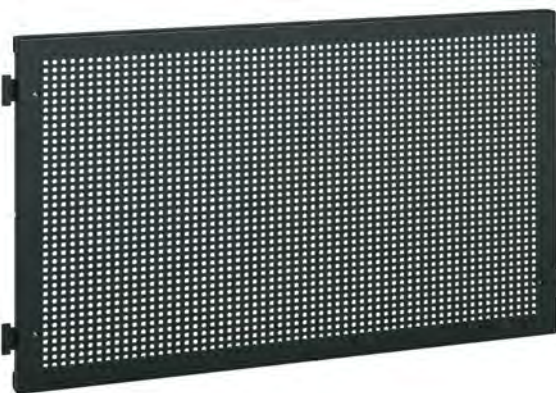

RSC50 PFS

€ P.O.A. 1 050001312

RSC50 PFI

Geperforeerd gereedschapspaneel, onderste deel, voor werkplaatsinrichting RSC50

- Afmetingen: 650x625x25 mm
- Geschikt voor een 19" multi-socket rek (niet inbegrepen)

3,8 kg



RSC50 PFI

€ P.O.A. 1 050001313

RSC50 P/2MDX-SX

Paar rechtse/linkste steunpalen, voor werkplaatsinrichting RSC50

8,5 kg

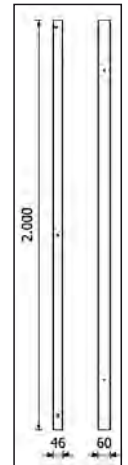

RSC50 P/2MDX-SX

€ P.O.A. 1 050001352

RSC50 PM

Wandkast voor werkplaatsinrichting RSC50

- Afmetingen: 740x300x400 mm
- Voorzien van gasveren, waardoor het makkelijker is om deur te openen en te sluiten
- Ontworpen voor toepassing van aluminium profielen met LED-strips item 5000 RSC50/PLED of 5000 RSC50/PLED-ST (apart te bestellen), om het werkgebied of de binnenkant van de kast te voorzien van licht

14 kg



30 kg

RSC50 PM

€ P.O.A. 1 050001302

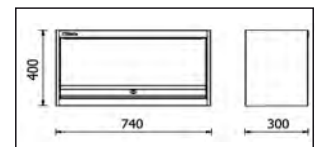

RSC50 MTP

driehoekige plank, voor werkplaatsinrichting RSC50

- Afmetingen: 740x300x400mm
- Geschikt voor geperforeerde gereedschapspanelen van hoekmodule
- Ontworpen voor het monteren van twee aluminium profielen met LED -strips Item 5000 RSC50/PLED (niet inbegrepen), om werkgebied te verlichten

6,5 kg



10 kg

RSC50 MTP

€ P.O.A. 1 050001305



RSC50 PS

Gereedschapswandsysteem met rolluik, voor werkplaatsinrichting RSC50

- Aluminium rolluik, verticaal verstelbaar, met slot
- Verwijderbare geperforeerde gereedschapspanelen
- geleverd met zelfdragend frame

77 kg



RSC50 PS

€ P.O.A. 1 050001360

RSC50 AC

Zelf-dragende complete hoek, voor werkplaatsinrichting RSC50

Eigenschappen:

- Werkblad, 630x630 mm, Beschermd door een schokbestendig, krasvrij PVC laag, bestand tegen koolwaterstoffen
- Onderste geperforeerde gereedschapspanelen, 650x625x25 mm, kunnen een rack multi-socket herbergen (niet inbegrepen)
- Twee bovenste geperforeerde gereedschapspanelen, 650x400x25mm
- Wordt geleverd met zelf-dragend frame

41 kg

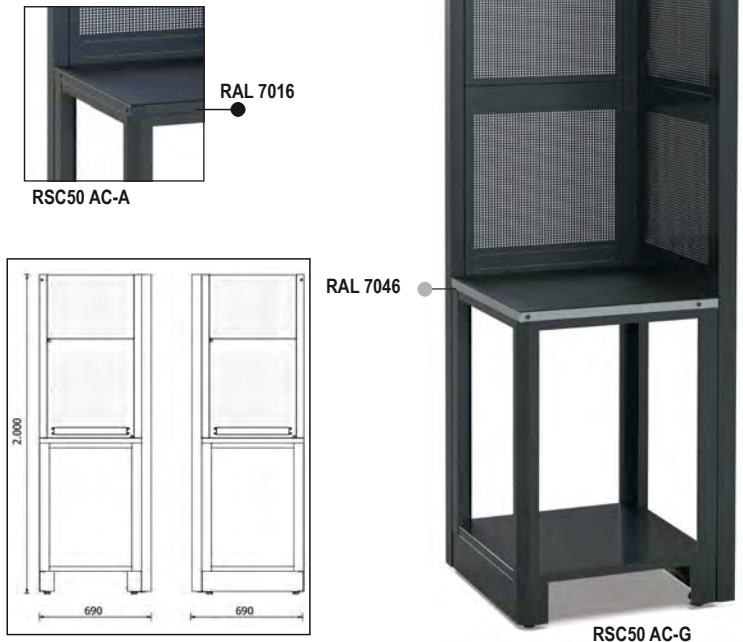

RSC50 AC-G

€ P.O.A. 1 050001330

RSC50 AC-A

P.O.A. 1 050001329

RSC50 KAI

Laag hoekelement, 630x630 mm, met poten

- Gepoedercoat werkblad (630x630 mm) beschermd met een schokbestendig, krasvrije PVC coating, bestand tegen koolwaterstoffen

16 kg



RSC50 KAI-G

€ P.O.A. 1 050001335

RSC50 KAI-A

P.O.A. 1 050001336

RSC50 A1

Plaatstalen enkeleurs gereedschapskast, voor werkplaatsinrichting RSC50

- 4 uitneembare, verticaal verstelbare planken
- handig opklapbaar kledingrek onder eerste plank
- met slot
- binnenafmetingen: 590x615 mm
- met verticaal verstelbare poten

66 kg

RSC50 A1 € P.O.A. 1 050001411

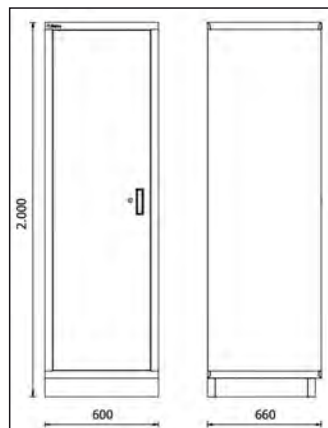

RSC50 A1/R59

binnenplank voor gereedschapskast RSC50 A1

RSC50 A1/R59 605x596 mm € P.O.A. 1 050001913

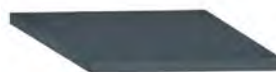

RSC50 A1/RB59

binnenplank voor gereedschapskast RSC50 A1, met kledingrek

RSC50 A1/RB59 605x596 mm € P.O.A. 1 050001914



RSC50 A2

Plaatstalen tweedeurs kast voor werkplaatsinrichting RSC50

- 4 verwijderbare, verticaal verstelbare planken
- met slot
- Binnenafmetingen: 910x615 mm
- In hoogte verstelbare pootjes

90 kg

RSC50 A2 € P.O.A. 1 050001412



RSC50 A2/R91

RSC50 A2/R91 911x596 mm € P.O.A. 1 050001915



5000 RSC50/MP

Wand opbergrek voor werkplaatsinrichting RSC50

- Afmetingen: 740x140x80 mm
- Ontworpen voor het monteren van aluminium profielen met ledstrips art. 5000 RSC50/PLED of 5000 RSC50/PLED-ST (afzonderlijk te bestellen), om werkgebied te verlichten

2,3 kg



5000 RSC50/MP

€ P.O.A. 1 050001705

5000 RSC50/MPA140

wand opbergrek, 140 mm diep, voor werkplaatsinrichtingcombinatie RSC50

- Afmetingen: 630x630x35mm, 140 mm diep
- Geschikt voor geperforeerde gereedschapspanelen van hoekmodule RSC50 AC
- Ontworpen voor het monteren van aluminium profiel met LED -strip item 5000 RSC50/PLED of 5000 RSC50/PLED-ST (niet inbegrepen), om werkgebied te verlichten

3 kg



5000 RSC50/MPA140

€ P.O.A. 1 050001706

5000 RSC50/CLL

Verlichtingsbak voor LED-strip, voor werkplaatsinrichting RSC50

- Afmetingen: 740x125x30 mm
- Geschikt voor geperforeerde gereedschapspanelen
- Ontworpen voor het monteren van één aluminium profiel met LED -strip item 5000 RSC50/PLED of 5000 RSC50/PLED-ST (niet inbegrepen), om werkgebied te verlichten

1 kg



5000 RSC50/CLL

€ P.O.A. 1 050001710

5000 RSC50/CAL

Verlichtingsbak voor LED-strip hoekopstelling, voor werkplaatsinrichting RSC50

- Afmetingen: 655x655x30 mm
- Geschikt voor geperforeerde gereedschapspanelen van hoekmodule
- Ontworpen voor het monteren van twee aluminium profielen met LED -strips Item 5000 RSC50/PLED (niet inbegrepen), om werkgebied te verlichten

1,7 kg



5000 RSC50/CAL

€ P.O.A. 1 050001711

5000 RSC50/KFC

Set van 10 gekleurde lade fronten voor werkplaatsinrichting RSC50

Om de kleur van ladefronten aan te passen voor werkplaatsinrichting RSC50. Aanbevolen voor gebruik in combinatie met werkbladen in antracietgrijs RAL7016 (-A).



5000 RSC50/KFC2011	■	€ P.O.A. 1 050001731
5000 RSC50/KFC3000	■	€ P.O.A. 1 050001733
5000 RSC50/KFC5015	■	€ P.O.A. 1 050001734
5000 RSC50/KFC7016	■	€ P.O.A. 1 050001737

 **Beta**

PROFESSIONEEL, ROBUUST EN EFFICIËNT

C45PRO is de professionele werkplaatsinrichting die u helpt het meest uit uw werkruimte te halen. Gebaseerd op het nieuwe 2021-ontwerp en de technische verbeteringen die voor het frame zijn ontwikkeld, biedt het een uitstekende prijs/kwaliteitverhouding.

Met de **modulaire werkplaatsinrichting, C45PRO**, kunt u uw eigen werkomgeving creëren afhankelijk van zowel de beschikbare ruimte als uw gebruikerseisen.

Dit eenvoudige, flexibele assortiment op basis van vooraf bepaalde combinaties kan later worden uitgebreid of gewijzigd. Als alternatief kunt u uw werkplek volledig aanpassen, te beginnen met de werkbladen – verkrijgbaar in MDF hout voorzien van een roestvast stalen afwerking of multiplex hout – en deze aan te vullen met talrijke onderdelen en accessoires waaruit u kunt kiezen.

**Pas uw werkomgeving aan uw behoefte aan.
Laat uw werkplaats of garage er anders uitzien.
Kies uit de reeds samengestelde sets of creëer uw eigen werkplek.**



DE WERKPLAATSRINRICHTING, C45, IS VAN UITERLIJK VERANDERD EN HEEFT DE BETA-KLEUREN GEKREGEN!

om uw gewenste **werkplaats on line** samen te stellen

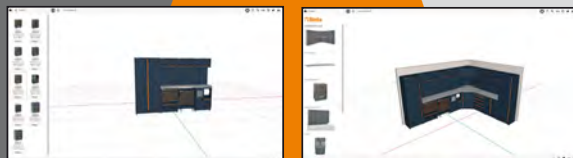

Ga naar www.beta-tools.com

C45PRO DX

Werkplaatsinrichting C45PRO

Samengesteld als volgt:

- 1 werkblad uit MDF, voorzien van roestvaststalen afwerking (C45PX/3-2,0MT)
- 1 werkblad uit MDF, voorzien van roestvaststalen afwerking (C45PX/2-1,3MT)
- 1 vast ladenblok met 7 laden (C45PRO M7)
- 1 gereedschapswagen met 7 laden (C45PRO C7)
- 1 vast service blok (C45PRO MS)
- 1 vast ladenblok met 5 laden (C45PRO M5)
- 1 twee deurs onderkast (C45PRO MA)
- 1 zelfdragende complete hoek uit MDF, voorzien van roestvaststalen afwerking (C45PRO CORNER/X)
- 5 geperforeerde gereedschapspanelen (C45PRO PF)
- 5 ophangkasten (C45PRO PM)
- 7 bevestigingssteunen, breed model (C45PRO SL)
- 2 bevestigingssteunen, smal model (C45PRO SS)
- 2 enkele deurs hoge kast (C45PRO AS1)

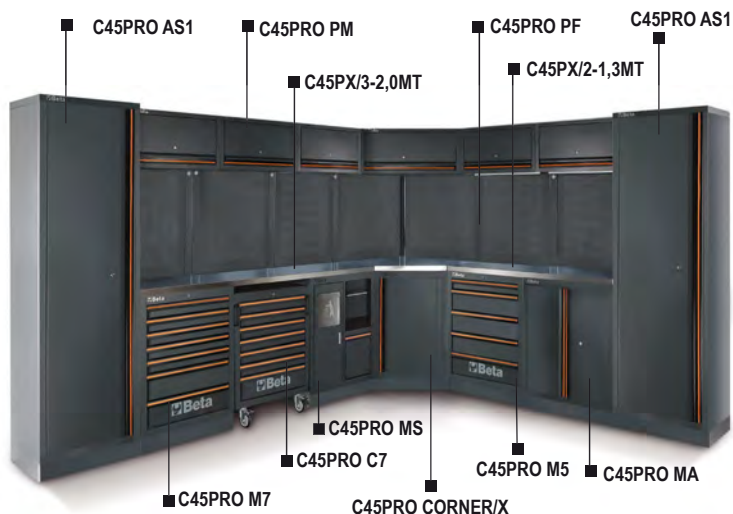

572,3 kg

C45PRO DW

Werkplaatsinrichting C45PRO

Samengesteld als volgt:

- 1 multiplex houten werkblad (C45PW/3-2.0MT)
- 1 multiplex houten werkblad (C45PW/2-1.3MT)
- 1 vast ladenblok met 7 laden (C45PRO M7)
- 1 gereedschapswagen met 7 laden (C45PRO C7)
- 1 vast serviceblok (C45PRO MS)
- 1 vast ladenblok met 5 laden (C45PRO M5)
- 1 twee deurs onderkast (C45PRO MA)
- 1 zelfdragende complete hoek met houten werkblad (C45PRO CORNER/W)
- 5 geperforeerde gereedschapspanelen (C45PRO PF)
- 5 ophangkasten (C45PRO PM)
- 7 bevestigingssteunen, breed model (C45PRO SL)
- 2 bevestigingssteunen, smal model (C45PRO SS)
- 2 enkele deurs hoge kast (C45PRO AS1)

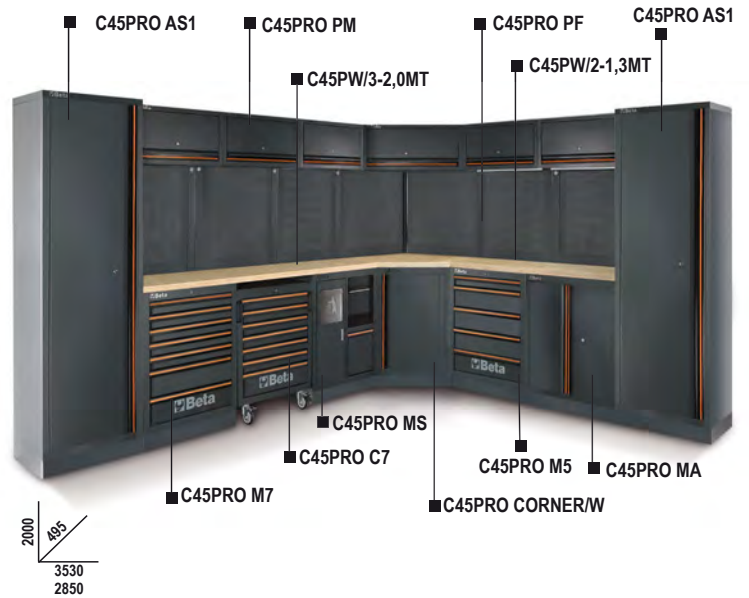

568,5 kg

C45PRO DW

€ P.O.A. 1 045000032

C45PRO FX

Werkplaatsinrichting C45PRO FX

Combinatie omvattende:

- 1 Werkblad uit MDF, voorzien van roestvaststalen afwerking (C45PX / 3-2.0MT)
- 1 Werkblad uit MDF, voorzien van roestvaststalen afwerking (C45PX / 2-1.3MT)
- 1 Vaste tweedeurs module (C45PRO MA)
- 1 Gereedschapswagen met 7 laden (C45PRO C7)
- 1 Vast ladenblok met 7 laden (C45PRO M7)
- 1 Vaste module met 3 laden en 2 ingebouwde haspels (C45PRO ACT)
- 1 Vaste servicemodule (C45PRO MS)
- 1 Zelfsteunende complete hoek met werkblad uit MDF, voorzien van roestvaststalen afwerking (C45PRO CORNER/X)
- 2 geperforeerde gereedschapspanelen (C45PRO PF)
- 1 geperforeerd gereedschapspaneel, kan worden uitgerust met een stopcontact (niet inbegrepen) (C45PRO PFE)
- 3 Wandkasten (C45PRO PM)
- 1 Gereedschapswandsysteem met aluminium rolluik (C45PRO PA)
- 6 wandbeugels, breed type (C45PRO SL)
- 2 wandbeugels, smal type (C45PRO SS)
- 2 Enkeldeurs gereedschapkasten (C45PRO AS1)

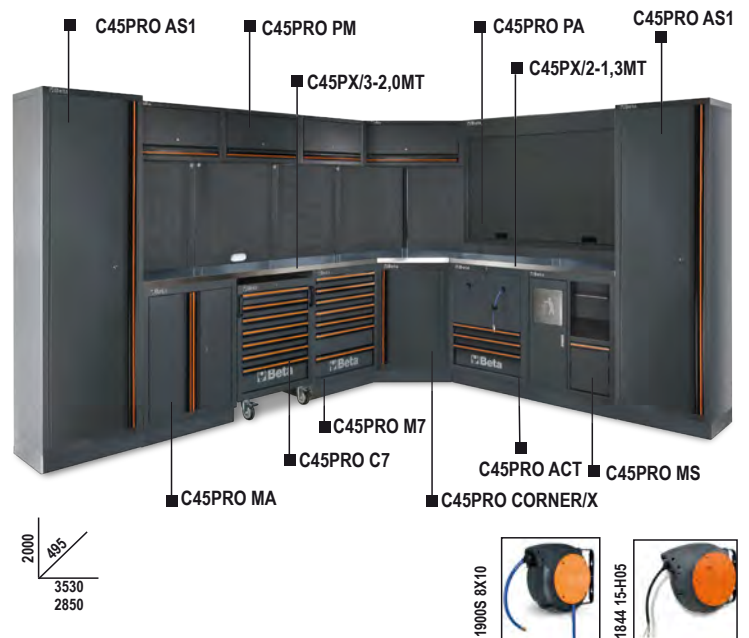

576 kg

C45PRO FX

€ P.O.A. 1 045000035

C45PRO FW

Werkplaatsinrichting C45PRO FW

Combinatie omvattende:

- 1 Meerlaags houten werkblad (C45PW / 3-2.0MT)
- 1 Meerlaags houten werkblad (C45PW / 2-1,3MT)
- 1 Vaste tweedeursmodule (C45PRO MA)
- 1 Gereedschapswagen met 7 laden (C45PRO C7)
- 1 Vaste module met 7 laden (C45PRO M7)
- 1 Vaste module met 3 laden en 2 ingebouwde haspels (C45PRO ACT)
- 1 Vaste servicemodule (C45PRO MS)
- 1 Zelfsteunende complete hoek met meerlaags houten werkblad (C45PRO CORNER/W)
- 2 geperforeerde gereedschapspanelen (C45PRO PF)
- 1 geperforeerd gereedschapspaneel, kan worden uitgerust met een stopcontact (niet inbegrepen) (C45PRO PFE)
- 3 Wandkasten (C45PRO PM)
- 1 Gereedschapswandsysteem met aluminium rolluik (C45PRO PA)
- 6 wandbeugels, breed type (C45PRO SL)
- 2 wandbeugels, smal type (C45PRO SS)
- 2 Enkeldeurs gereedschapkasten (C45PRO AS1)

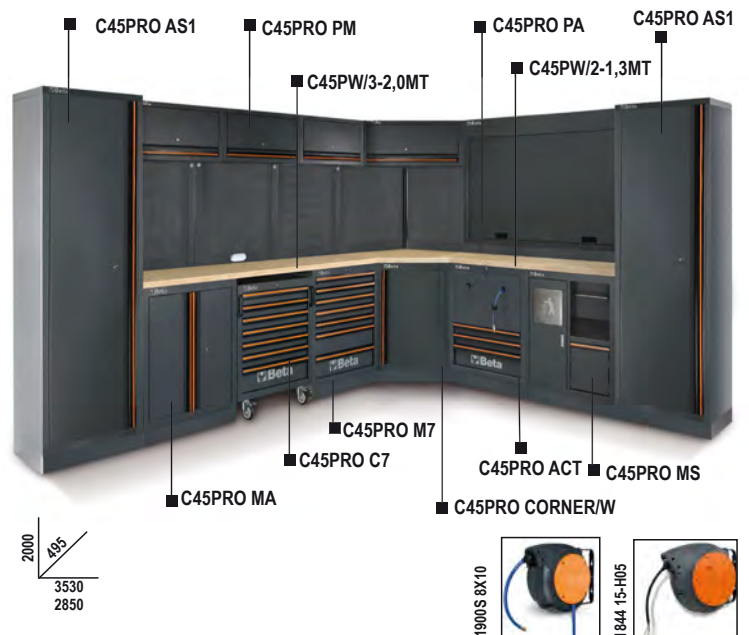

572 kg

C45PRO FW

€ P.O.A. 1 045000045

C45PRO GX

Werkplaatsinrichting C45PRO GX

Combinatie omfattende:

- 1 Werkblad uit MDF, voorzien van roestvaststalen afwerking (C45PX / 3-2.0MT)
- 1 Werkblad uit MDF, voorzien van roestvaststalen afwerking (C45PX / 1-0.7MT)
- 1 Vaste module met 3 laden en 2 ingebouwde haspels (C45PRO ACT)
- 1 Gereedschapswagen met 7 laden (C45PRO C7)
- 1 Vaste module met 7 laden (C45PRO M7)
- 1 Vaste tweedeurs module (C45PRO MA)
- 1 Zelfsteunende complete hoek met werkblad uit MDF, voorzien van roestvaststalen afwerking (C45PRO CORNER/X)
- 1 geperforeerd gereedschapspaneel (C45PRO PF)
- 1 geperforeerd gereedschapspaneel, kan worden uitgerust met een stopcontact (niet inbegrepen) (C45PRO PFE)
- 2 Wandkasten (C45PRO PM)
- 1 Gereedschapswandsysteem met aluminium rolluik (C45PRO PAS)
- 6 wandbeugels, breed type (C45PRO SL)
- 2 wandbeugels, smal type (C45PRO SS)
- 2 Enkeldeurs gereedschapskasten (C45PRO AS1)

507 kg

C45PRO GX

€ P.O.A. 1 045000036

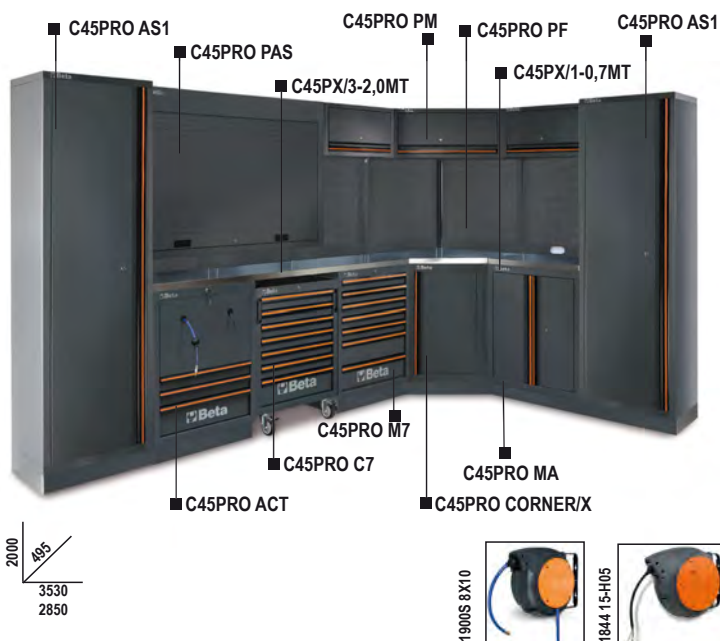

C45PRO GW

Werkplaatsinrichting C45PRO GW

Combinatie omfattende:

- 1 Meerlaags houten werkblad (C45PW / 3-2.0MT)
- 1 Meerlaags houten werkblad (C45PW / 1-0.7MT)
- 1 Vaste module met 3 laden en 2 ingebouwde haspels (C45PRO ACT)
- 1 Gereedschapswagen met 7 laden (C45PRO C7)
- 1 Vaste module met 7 laden (C45PRO M7)
- 1 Vaste module met ingebouwde spoelbak (C45PRO ML)
- 1 Zelfsteunende complete hoek met meerlaags houten werkblad (C45PRO CORNER/W)
- 1 geperforeerd gereedschapspaneel (C45PRO PF)
- 1 geperforeerd gereedschapspaneel, kan worden uitgerust met een stopcontact (niet inbegrepen) (C45PRO PFE)
- 2 Wandkasten (C45PRO PM)
- 1 Gereedschapswandsysteem met aluminium rolluik (C45PRO PAS)
- 6 wandbeugels, breed type (C45PRO SL)
- 2 wandbeugels, breed type (C45PRO SS)
- 2 Enkeldeurs gereedschapskasten (C45PRO AS1)

504 kg

C45PRO GW

€ P.O.A. 1 045000037

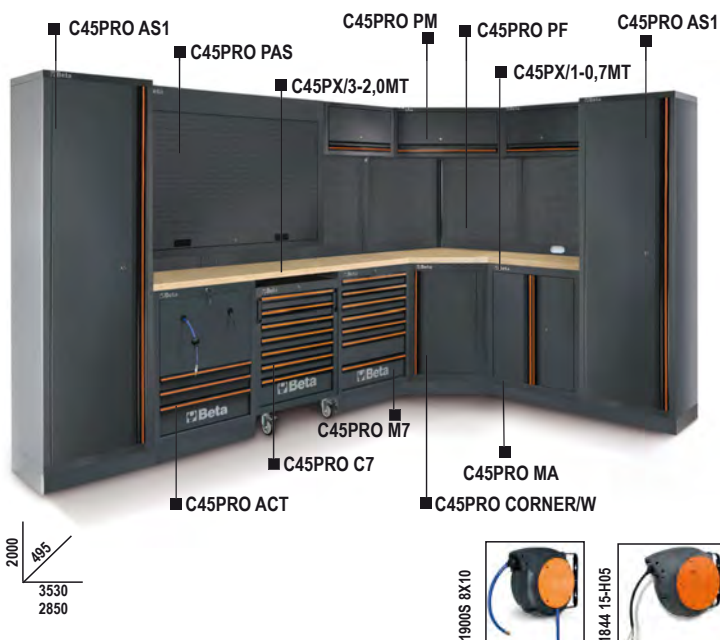

C45PRO X

Werkplaatsinrichting C45PRO

Samengesteld als volgt:

- Werkblad uit MDF, voorzien van een roestvaststalen afwerking (C45PX/3-2.0MT)
- Vast ladenblok met 7 laden (C45PRO M7)
- Vast service blok (C45PRO MS)
- Gereedschapswagen met 7 laden (C45PRO C7)
- Tweedeurs hoge kast (C45PRO AS2)
- 3 geperforeerde gereedschapspanelen (C45PRO PF)
- 3 ophangkasten (C45PRO PM)
- 3 bevestigingssteunen, breed model (C45PRO SL)
- 1 bevestigingssteun, smal model (C45PRO SS)

305 kg

C45PRO X

€ P.O.A. 1 045000001

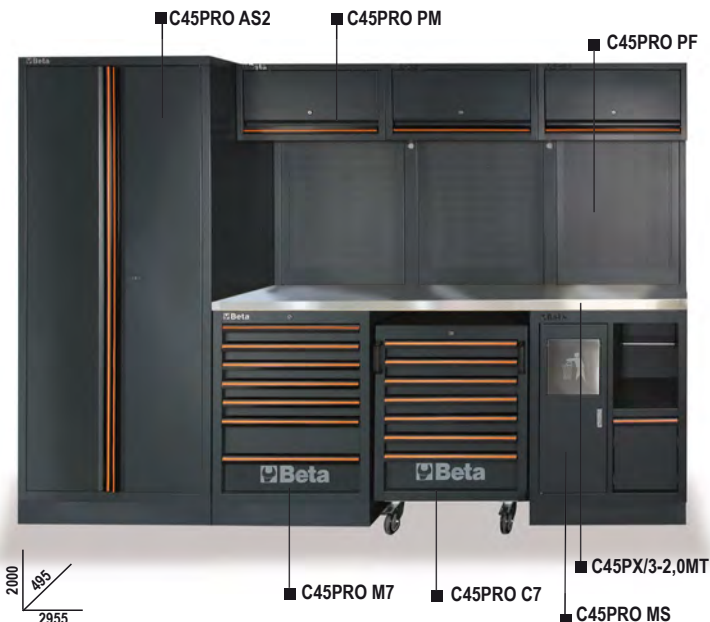

C45PRO W

Werkplaatsinrichting C45PRO W

Samengesteld als volgt:

- Multiplex houten werkblad (C45PW/3-2,0MT)
- Vast ladenblok met 7 laden (C45PRO M7)
- Vast service blok (C45PRO MS)
- Gereedschapswagen met 7 laden (C45PRO C7)
- Tweedeurs hoge kast (C45PRO AS2)
- 3 geperforeerde gereedschapspanelen (C45PRO PF)
- 3 ophangkasten (C45PRO PM)
- 3 bevestigingssteunen, breed model (C45PRO SL)
- 1 bevestigingssteun, smal model (C45PRO SS)

303 kg

C45PRO W

€ P.O.A. 1 045000002

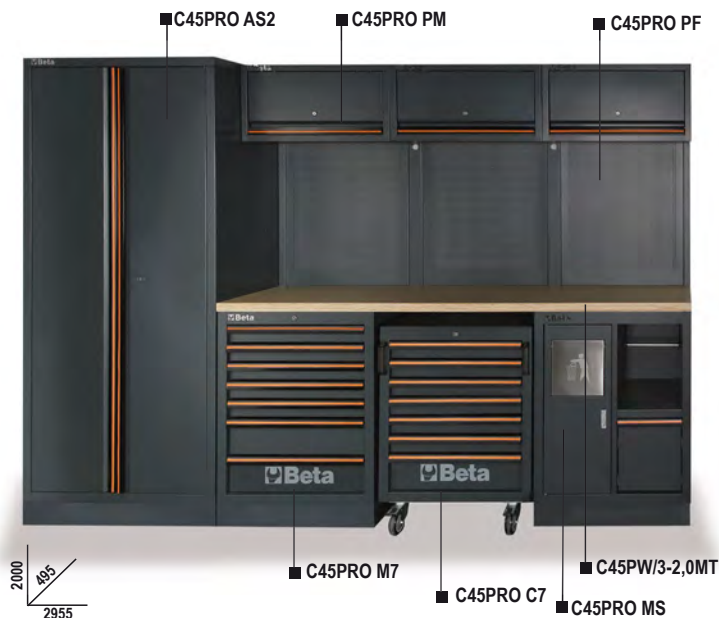

C45PRO HX

Werkplaatsinrichting C45PRO HX

Combinatie omvattende:

- 1 Werkblad uit MDF, voorzien van roestvaststalen afwerking (C45PX / 3-2,0MT)
- 1 Vaste module met 3 laden en 2 ingebouwde haspels (C45PRO ACT)
- 1 Gereedschapswagen met 7 laden (C45PRO C7)
- 1 Vaste module met 4 laden (C45PRO M4)
- 3 Wandkasten (C45PRO PM)
- 3 geperforeerde gereedschapspanelen (C45PRO PF)
- 3 wandbeugels, breed type (C45PRO SL)
- 1 wandbeugel, smal type (C45PRO SS)
- 1 Tweedeurs gereedschapskast (C45PRO AS2)

300 kg

C45PRO HX

€ P.O.A. 1 045000038

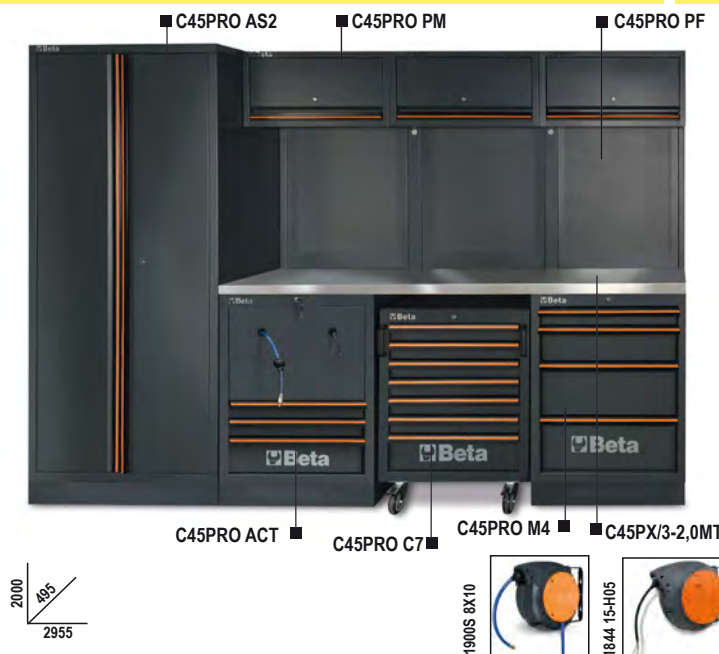

C45PRO HW

Werkplaatsinrichting C45PRO HW

Combinatie omvattende:

- 1 Meerlaags houten werkblad (C45PX / 3-2,0MT)
- 1 Vaste module met 3 laden en 2 ingebouwde haspels (C45PRO ACT)
- 1 Gereedschapswagen met 7 laden (C45PRO C7)
- 1 Vaste module met 4 laden (C45PRO M4)
- 3 Wandkasten (C45PRO PM)
- 3 geperforeerde gereedschapspanelen (C45PRO PF)
- 3 wandbeugels, breed type (C45PRO SL)
- 1 wandbeugel, smal type (C45PRO SS)
- 1 Tweedeurs gereedschapskast (C45PRO AS2)

299 kg

C45PRO HW

€ P.O.A. 1 045000039

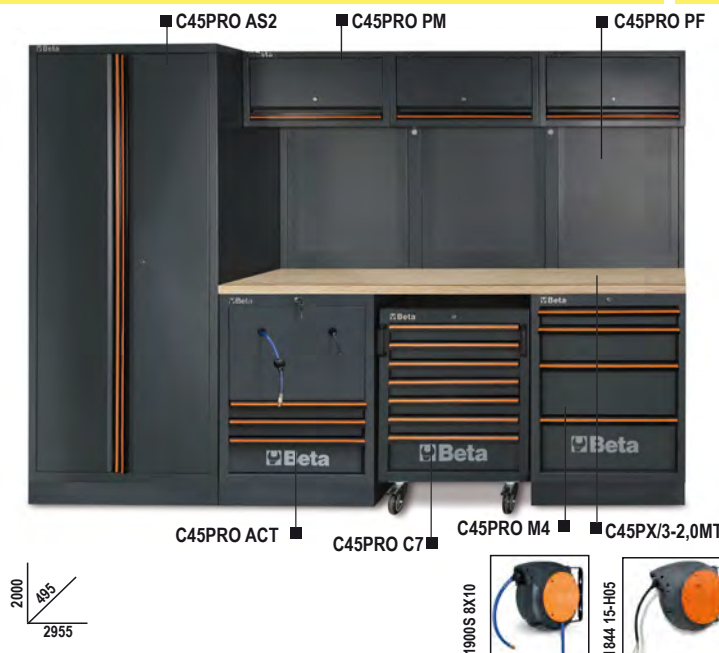

C45PRO AX

Werkplaatsinrichting C45PRO

Samengesteld als volgt:

- Werkblad uit MDF voorzien van roestvaststalen afwerking (C45PX/3-2.0MT)
- Vast ladenblok met 7 laden (C45PRO M7)
- Vast service blok (C45PRO MS)
- Twee deurs onderkast (C45PRO MA)
- 3 ophangkasten (C45PRO PM)
- 3 geperforeerde gereedschapspanelen (C45PRO PF)
- 2 bevestigingssteunen, breed model (C45PRO SL)
- 2 bevestigingssteunen, smal model (C45PRO SS)

206 kg

C45PRO AX

€ P.O.A. 1 045000003



C45PRO AW

Werkplaatsinrichting C45PRO

Samengesteld als volgt:

- Multiplex houten werkblad (C45PW/3-2.0MT)
- Vast ladenblok met 2 laden (C45PRO MA)
- Vast ladenblok met 7 laden (C45PRO M7)
- Vast service blok (C45PRO MS)
- 3 ophangkasten (C45PRO PM)
- 3 geperforeerde gereedschapspanelen (C45PRO PF)
- 2 bevestigingssteunen, smal model (C45PRO SS)
- 2 bevestigingssteunen, breed model (C45PRO SL)

204 kg

C45PRO AW

€ P.O.A. 1 045000004



C45PRO BX

Werkplaatsinrichting C45PRO

Samengesteld als volgt:

- Werkblad uit MDF, voorzien van roestvaststalen afwerking (C45PX/2-1.3MT)
- Vast ladenblok met 5 laden (C45PRO M5)
- Twee deurs onderkast (C45PRO MA)
- Enkel deur hoge kast (C45PRO AS1)
- 2 ophangkasten (C45PRO PM)
- 2 geperforeerde gereedschapspanelen (C45PRO PF)
- 2 bevestigingssteunen, breed model (C45PRO SL)
- 1 bevestigingssteun, smal model (C45PRO SS)

191 kg

C45PRO BX

€ P.O.A. 1 045000021



C45PRO BW

Werkplaatsinrichting C45PRO

Samengesteld als volgt:

- Multiplex houten werkblad (C45PW/2-1,3MT)
- Vast ladenblok met 5 laden (C45PRO M5)
- Twee deurs onderkast (C45PRO MA)
- Enkel deurs hoge kast (C45PRO AS1)
- 2 ophangkasten (C45PRO PM)
- 2 geperforeerde gereedschapspanelen (C45PRO PF)
- 2 bevestigingssteunen, breed model (C45PRO SL)
- 1 bevestigingssteun, smal model (C45PRO SS)

190 kg

C45PRO BW

€ P.O.A. 1 045000022

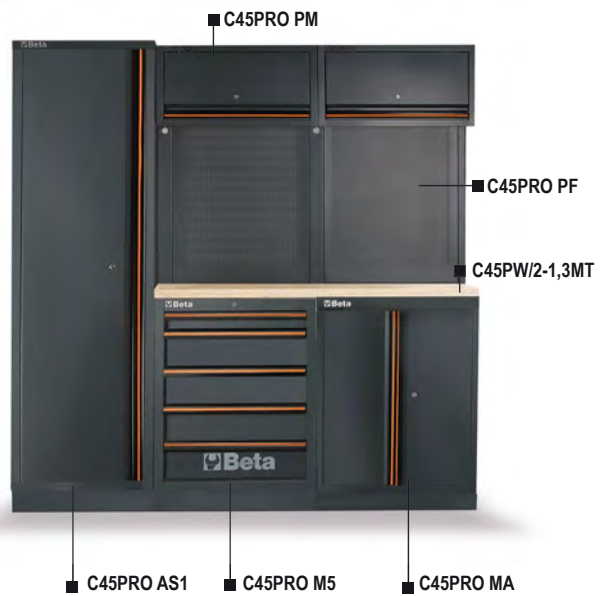

C45PRO EX

Samengestelde werkplaatsinrichting C45PRO

Combinatie bestaande uit:

- 2 geperforeerde gereedschapspanelen (C45PRO PF)
- 2 wandkasten (C45PRO PM)
- 2 muurbeugels breed type (C45PRO SL)
- 1 muurbeugel smal type (C45PRO SS)
- 1 enkele deur kast (C45PRO AS1)
- Vaste module met 7 laden en RVS gecoat MDF werkblad (C45PRO M7A/X):
 - 1 lade, 1248x406 mm
 - 6 laden, 782x406 mm
 - 5 laden, 65 mm hoog
 - 1 lade, 145 mm hoog
- 1 opbergvak met tussenschap en deur

174,6 kg

C45PRO EX

€ P.O.A. 1 045000033



C45PRO EW

Samengestelde werkplaatsinrichting C45PRO

Combinatie bestaande uit:

- 2 geperforeerde gereedschapspanelen (C45PRO PF)
- 2 wandkasten (C45PRO PM)
- 2 muurbeugels, breed type (C45PRO SL)
- 1 muurbeugel smal type (C45PRO SS)
- 1 enkele deurs gereedschapskast (C45PRO AS1)
- Vaste module met 7 laden en werkblad van multiplex (C45PRO M7A/W):
 - 1 lade, 1248x406 mm
 - 6 laden, 782x406 mm
 - 5 laden, 65 mm hoog
 - 1 lade, 145 mm hoog
- 1 opbergvak met tussenschap en deur

173,6 kg

C45PRO EW

€ P.O.A. 1 045000034



C45PRO CX

werkplaatsinrichting C45PRO

Combinatie bestaande uit:

- Werkblad van RVS gecoat MDF (C45PX/2-1.3MT)
- Vaste module met 7 laden (C45PRO M7)
- Vaste servicemodule (C45PRO MS)
- Enkele deur kast (C45PRO AS1)
- 2 wandkasten (C45PRO PM)
- 2 geperforeerde gereedschapspanelen (C45PRO PF)
- 2 zijwandbeugels, breed type (C45PRO SL)
- 1 zijwandbeugel, smal type (C45PRO SS)

199 kg

C45PRO CX

€ P.O.A. 1 045000023



C45PRO CW

Samengestelde werkplaatsinrichting C45PRO

Combinatie bestaande uit:

- Meerlaags houten werkblad (C45PW/2-1.3MT)
- Vaste module met 7 laden (C45PRO M7)
- Vaste servicemodule (C45PRO MS)
- Enkeldeurs kast (C45PRO AS1)
- 2 wandkasten (C45PRO PM)
- 2 geperforeerde gereedschapspanelen (C45PRO PF)
- 2 muurbeugels, breed type (C45PRO SL)
- 1 muurbeugel, smal type (C45PRO SS)

198 kg

C45PRO CW

€ P.O.A. 1 045000024



C45PRO BPX-2,0

Samengestelde werkplaatsinrichting C45PRO

Combinatie bestaande uit:

- Werkblad van RVS gecoat MDF (C45PX/3-2.0MT)
- Vaste module met 7 laden (C45PRO M7)
- Vaste module met 5 laden (C45PRO M5)
- 3 geperforeerde gereedschapspanelen (C45PRO PF)
- 2 muurbeugels, breed type (C45PRO SL)
- 2 muurbeugels, smal type (C45PRO SS)

158 kg

C45PRO BPX-2,0

€ P.O.A. 1 045000042



C45PRO BPW-2,0

Samengestelde werkplaatsinrichting C45PRO

Combinatie bestaande uit:

- Meerlaags houten werkblad (C45PW/3-2,0MT)
- Vaste module met 7 laden (C45PRO M7)
- Vaste module met 5 laden (C45PRO M5)
- 3 geperforeerde gereedschapspanelen (C45PRO PF)
- 2 muurbeugels, breed type (C45PRO SL)
- 2 muurbeugels, smalle uitvoering (C45PRO SS)

156 kg

C45PRO BPW-2,0

€ P.O.A. 1 045000052



C45PRO BPX-1,3

Samengestelde werkplaatsinrichting C45PRO

Combinatie bestaande uit:

- Werkblad van RVS gecoat MDF (C45PX/2-1.3MT)
- Vaste module met 7 laden (C45PRO M7)
- Vaste module met 5 laden (C45PRO M5)
- 2 geperforeerde gereedschapspanelen (C45PRO PF)
- 1 muurbeugel, breed type (C45PRO SL)
- 2 muurbeugels, smal type (C45PRO SS)

140 kg

C45PRO BPX-1,3

€ P.O.A. 1 045000041

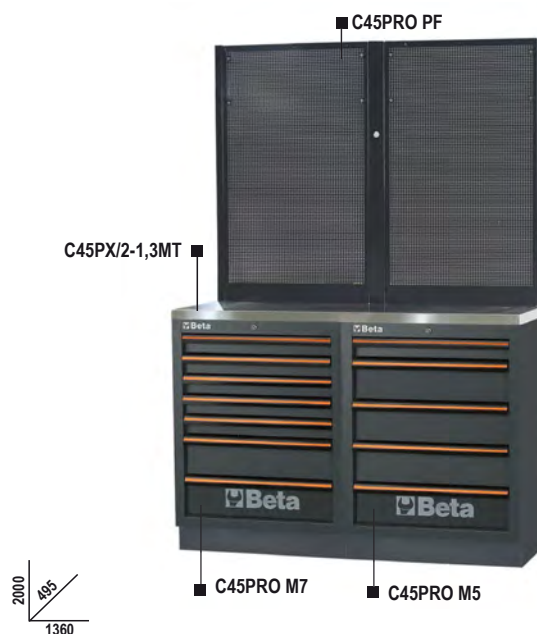

C45PRO BPW-1,3

Samengestelde werkplaatsinrichting C45PRO

Combinatie bestaande uit:

- Meerlaags houten werkblad (C45PW/2-1.3MT)
- Vaste module met 7 laden (C45PRO M7)
- Vaste module met 5 laden (C45PRO M5)
- 2 geperforeerde gereedschapspanelen (C45PRO PF)
- 1 muurbeugel, breed type (C45PRO SL)
- 2 muurbeugels, smal type (C45PRO SS)

139 kg

C45PRO BPW-1,3

€ P.O.A. 1 045000051

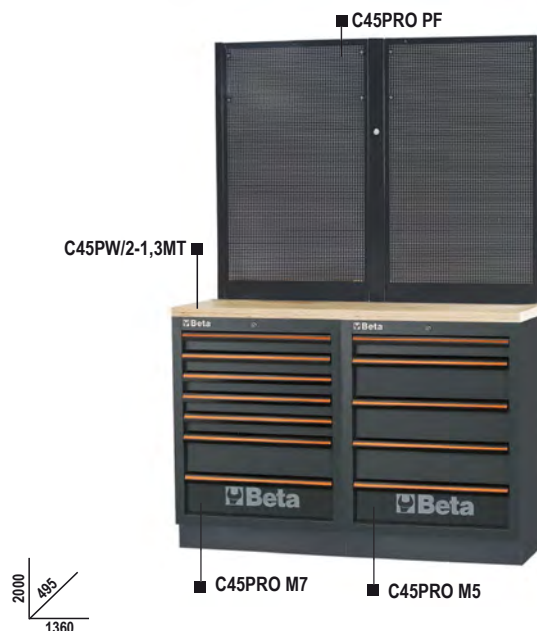

C45PRO M7A/X

Vaste module met 7 laden, voor werkplaatsinrichting C45PRO

- werkblad (1360 mm) van RVS gecoat MDF
- 1 lade (1248x406 mm) met kogelgelagerde geleiders
- 6 laden (782x406 mm) met kogelgelagerde geleiders:
5 laden 65 mm hoog
1 lade 145 mm hoog
- ladebodems beschermd door schuimrubberen matten
- centrale vergrendeling voorzijde
- met verticaal verstelbare poten
- kan worden voorzien van inlays
- 1 opbergvak met tussenplank en deur, binnenafmetingen 504x424x597 mm
- Er is plaats voor een bankschroef (1599P/150, apart te bestellen)

81 kg

C45PRO M7A/X

€ P.O.A. 1 045000161



h	max
65 mm	25 kg
105 mm	40 kg
145 mm	30 kg

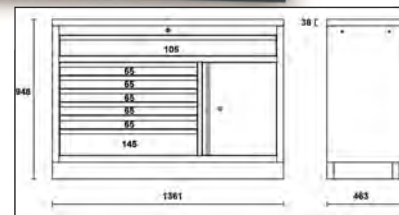

C45PRO M7A/W

Vaste module met 7 laden, voor werkplaatsinrichting C45PRO

- meerlaags houten werkblad (1360 mm)
- 1 lade (1248x406 mm) met kogelgelagerde geleiders
- 6 laden (782x406 mm) met kogelgelagerde geleiders:
5 laden 65 mm hoog
1 lade 145 mm hoog
- ladebodems beschermd door schuimrubberen matten
- centrale vergrendeling voorzijde
- met verticaal verstelbare poten
- kan worden voorzien van inlays
- 1 opbergvak met tussenplank en deur, binnenafmetingen 504x424x597 mm
- Er is plaats voor een bankschroef (1599P/150, apart te bestellen)

80 kg

C45PRO M7A/W

€ P.O.A. 1 045000171



h	max
65 mm	25 kg
105 mm	40 kg
145 mm	30 kg

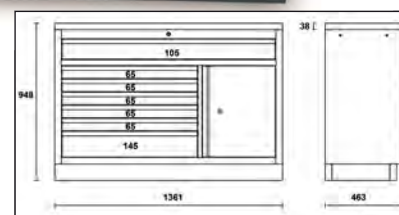

C45PRO MWS/X

Verrijdbare werkbank met 7 laden en ingebouwde afvalbak

- werkblad (1680 mm) van RVS gecoat MDF
- 1 lade (1248x406 mm) met kogelgelagerde geleiders
- 6 laden (782x406 mm) met kogelgelagerde geleiders:
5 laden 65 mm hoog
1 lade 145 mm hoog
- ladebodems beschermd door schuimrubberen matten
- kan worden voorzien van inlays
- opbergvak met tussenplank en deur, binnenafmetingen 504x424x597 mm
- ingebouwde afvalbak
- ingebouwd papierrolhouder
- 4 zware wielen, Ø 150 mm, 2 vaste en 2 zwenkwielen met rem
- centrale vergrendeling voorzijde
- Er is plaats voor een bankschroef (1599P/150, apart te bestellen)

126 kg

C45PRO MWS/X

€ P.O.A. 1 045000181



h	max
65 mm	25 kg
105 mm	40 kg
145 mm	30 kg

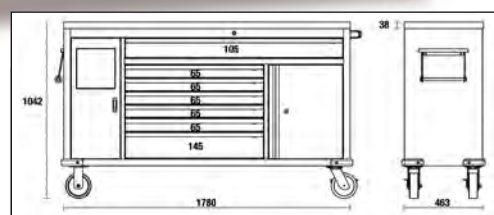

C45PRO MWS/W

Verrijdbare werkbank met 7 laden en ingebouwde afvalbak

- meerlaags houten werkblad (1680 mm)
- 1 lade (1248x406 mm) met kogelgelagerde geleiders
- 6 laden (782x406 mm) met kogelgelagerde geleiders:
 - 5 laden 65 mm hoog
 - 1 lade 145 mm hoog
- ladebodems beschermd door schuimrubberen matten
- kan worden voorzien van inlays
- opbergvak met tussenplank en deur, binnenafmetingen 504x424x597 mm
- ingebouwde afvalbak
- ingebouwd papierrolhouder
- 4 zware wielen, Ø 150 mm, 2 vaste en 2 zwenkwielen met rem
- centrale vergrendeling voorzijde
- Er is plaats voor een bankschroef (1599P/150, apart te bestellen)

122 kg



h	max
65 mm	25 kg
105 mm	40 kg
145 mm	30 kg

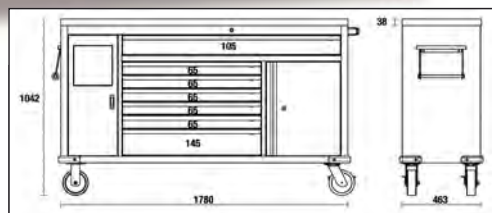

C45PRO MWS/W

€ P.O.A. 1 045000191

C45PRO CPF

paar geperforeerde gereedschapspanelen voor C45PRO MWS

Compleet geleverd met frame
Inclusief 50 haken KIT-GPS

21 kg



C45PRO CPF

€ P.O.A. 1 045000195

C45PX/1-0,7MT

werkblad van RVS gecoat MDF, 680x463 mm,
voor werkplaatsinrichting C45PRO

- dikte: 38 mm
- Er is plaats voor een bankschroef (1599P/150, apart te bestellen)

6 kg



C45PX/1-0,7MT

€ P.O.A. 1 045000101

C45PW/1-0,7MT

meerlaags houten werkblad, 680x463 mm,
voor werkplaatsinrichting C45PRO

- dikte: 38 mm
- Er is plaats voor een bankschroef (1599P/150, apart te bestellen)

6 kg



C45PW/1-0,7MT

€ P.O.A. 1 045000111

C45PX/2-1,3MT

werkblad van RVS gecoat MDF, 1360x463 mm,
voor werkplaatsinrichting C45PRO

- dikte: 38 mm
- Er is plaats voor een bankschroef (1599P/150, apart te bestellen)

📦 21 kg

C45PX/2-1,3MT € P.O.A. 1 045000103



C45PW/2-1,3MT

meerlaags houten werkblad, 1360x463 mm,
voor werkplaatsinrichting C45PRO

- dikte: 38 mm
- Er is plaats voor een bankschroef (1599P/150, apart te bestellen)

📦 20 kg

C45PW/2-1,3MT € P.O.A. 1 045000113



C45PX/3-2,0MT

werkblad van RVS gecoat MDF, 240x463 mm,
voor werkplaatsinrichting C45PRO

- dikte: 38 mm
- Er is plaats voor een bankschroef (1599P/150, apart te bestellen)

📦 31,8 kg

C45PX/3-2,0MT € P.O.A. 1 045000110



C45PW/3-2,0MT

meerlaags houten werkblad, 2040x463 mm,
voor werkplaatsinrichting C45PRO

- dikte: 38 mm
- Er is plaats voor een bankschroef (1599P/150, apart te bestellen)

📦 30 kg

C45PW/3-2,0MT € P.O.A. 1 045000120



C45PRO C5

Gereedschapswagen met 5 laden, voor werkplaatsinrichting C45PRO

- 5 laden (532x406 mm) met kogelgelagerde geleiders
- 4 zwenkwielen, Ø 100 mm (2 met rem)
- Ladebodems beschermd door schuimrubberen matten
- Gecentraliseerde vergrendeling vooraan
- Kan worden voorzien van inlays en vakverdelers
- Handgrepen ingebouwd in frame voor meer gebruiksgemak

📦 46 kg

C45PRO C5 € P.O.A. 1 045000225

h	max
65 mm	25 kg
145 mm	30 kg

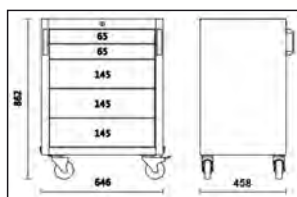
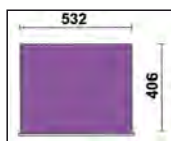

C45PRO C7

Gereedschapswagen met 7 laden, voor werkplaatsinrichting C45PRO

- 7 laden (532x406 mm) met kogelgelagerde geleiders
- 4 stuurwielen, Ø 100 mm (2 met rem)
- Ladenbodems beschermd door schuimrubberen matten
- Gecentraliseerde vergrendeling vooraan
- Kan worden voorzien van inlays
- Handgrepen ingebouwd in frame voor meer gebruiksgemak

50 kg

C45PRO C7

€ P.O.A. 1 045000227

h	max
65 mm	25 kg
145 mm	30 kg

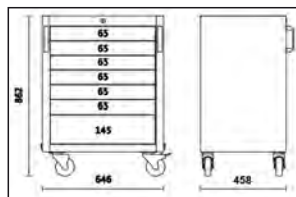
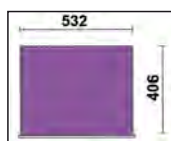

C45PRO M4

vaste module met 4 lades, voor werkplaatsinrichting C45PRO

- 4 laden (566x406 mm) met kogelgelagerde geleiders
- Ladenbodems beschermd door schuimrubberen matten
- Centraal slot
- Met verticaal verstelbare poten
- Kan worden voorzien van inlays

45,7 kg

C45PRO M4

€ P.O.A. 1 045000234

h	max
65 mm	25 kg
145 mm	30 kg
225 mm	30 kg

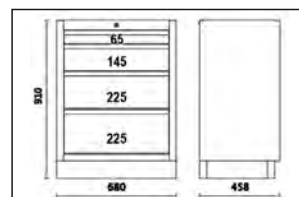

C45PRO M5

vaste module met 5 lades, voor werkplaatsinrichting C45PRO

- 5 laden (566x406 mm) met kogelgelagerde geleiders
- Ladenbodems beschermd door schuimrubberen matten
- Centraal slot
- Met verticaal verstelbare poten
- Kan worden voorzien van inlays

49,3 kg

C45PRO M5

€ P.O.A. 1 045000235

h	max
65 mm	25 kg
145 mm	30 kg

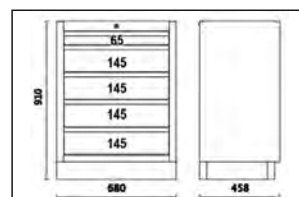

C45PRO M7

vaste module met 7 laden, voor werkplaatsinrichting C45PRO

- 7 laden (566x406 mm) met kogelgelagerde geleiders
- Ladebodems beschermd door schuimrubberen matten
- Gecentraliseerde vergrendeling vooraan
- Met verticaal verstelbare poten
- Kan worden voorzien van gethermovormde trays

54,3 kg

h	max
65 mm	25 kg
145 mm	30 kg

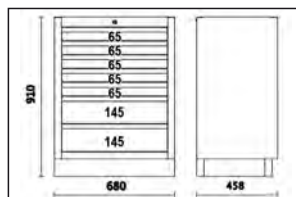
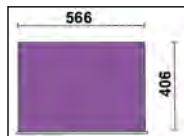

C45PRO M7

€ P.O.A. 1 045000237

C45PRO M8

vaste module met 8 laden, voor werkplaatsinrichting combinatie C45PRO

- 8 laden (566x406 mm) met kogelgelagerde geleiders
- Ladenbodems beschermd door schuimrubberen matten
- Gecentraliseerde vergrendeling vooraan
- Met verticaal verstelbare poten
- Kan worden voorzien van inlays en vakverdelers

56,5 kg

h	max
65 mm	25 kg
145 mm	30 kg

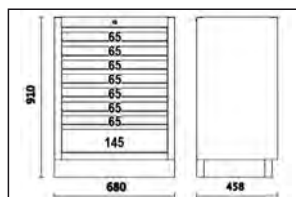
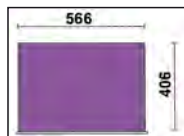

C45PRO M8

€ P.O.A. 1 045000238

C45PRO MS

vaste servicemodule voor werkplaatsinrichting C45PRO

- Ingebouwde afvalbak
- Papierrolcompartment
- Met verticaal verstelbare poten

37 kg

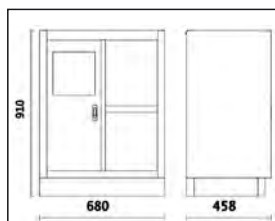

C45PRO MS

€ P.O.A. 1 045000239

C45PRO RD/X

vaste afvalinzamelmodule voor werkplaatsinrichting C45PRO

De ideale oplossing voor gesorteerde afvalinzameling (glas, papier, plastic...)

- RVS gecoat MDF werkblad, 1360 mm lang
- Stevig plaatstalen frame compleet met 4 containers met kanteldeur voor het sorteren van afval
- Elke container is voorzien van:
een uitneembare plastic bak; inhoud: 25 l
- 4 zwenkwielen, Ø 60 mm
- Geleverd met set van 4 kleuren tape
- Met verticaal verstelbare poten

80 kg

C45PRO RD/X	€		1		045000241
C45PRO RD/W	P.O.A.		1		045000240



C45PRO RD/X



C45PRO RD/W

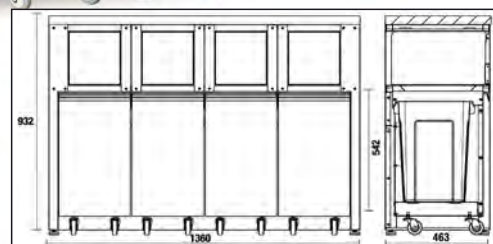

C45PRO MA

vaste tweedeurs module voor werkplaatsinrichting C45PRO

- Met slot
- Verticaal verstelbare binnenplank
- Binnenafmetingen 670x420 mm
- Met verticaal verstelbare poten

29,4 kg

C45PRO MA	€		1		045000232
-----------	---	--	---	--	-----------

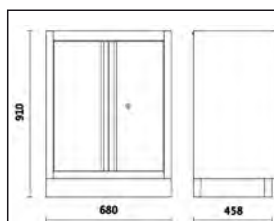

C45PRO MAL

vaste module, 1360 mm lang, met 2 deuren, voor werkplaatsuitrustingcombinatie C45PRO

- Met slot
- Verticaal verstelbare plank
- Binnenafmetingen: 670x420 mm
- Met verticaal verstelbare poten

44,8 kg

C45PRO MAL	€		1		045000229
------------	---	--	---	--	-----------

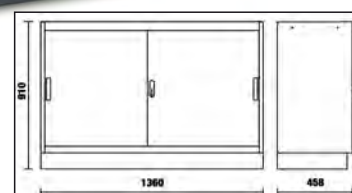

C45PRO MAT

vaste module, 1360 mm lang, met 2 heldere polycarbonaat deuren, voor werkplaatsuitrustingcombinatie C45PRO

- Met slot
- Verticaal verstelbare plank
- Binnenafmetingen: 670x420 mm
- Met verticaal verstelbare poten

44,1 kg

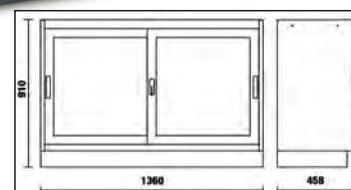

C45PRO MAT

€ P.O.A. 1 045000230

C45PRO M3A

vaste module met 3 laden en 2 deuren, voor werkplaatsinrichting combinatie C45PRO

- 3 laden (566x406 mm) met kogelgelagerde geleiders
- Ladebodems beschermd door schuimrubberen matten
- Kan worden voorzien van inlays en vakverdelers
- Gecentraliseerde vergrendeling vooraan
- Opbergvak met dubbele deur en slot (binnenmaat 670x440 mm), compleet met tussenschap
- Met verticaal verstelbare poten

44 kg

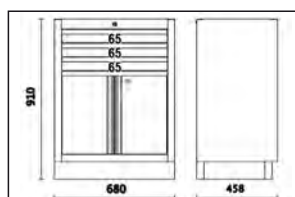
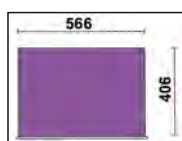
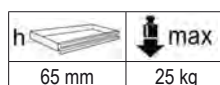

C45PRO M3A

€ P.O.A. 1 045000231

C45PRO ML

vaste module met ingebouwde spoelbak, voor werkplaatsinrichting C45PRO

Technische specificaties:

- Roestvasstalen wastafel.
- Compleet geleverd met:
 - 1 mengkraan
 - 1 afvoerunit
 - 1 gootsteenstop
 - 1 filterdop
 - 1 zeepdispenser

Vaste tweedeursmodule met slot:

- Nuttige binnenafmetingen 600x603x416 mm
- Met verticaal verstelbare poten

44 kg

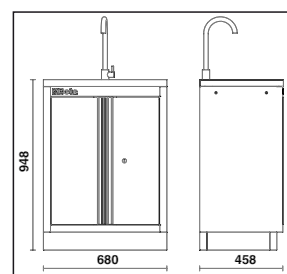

C45PRO ML

€ P.O.A. 1 045000233

C45PRO ACT

vaste module met 3 laden en 2 ingebouwde haspels voor werkplaatsinrichting combinatie C45PRO

- 3 laden (566x406 mm) met kogelgelagerde geleiders
- Ladebodems beschermd door schuimrubberen matten
- Gecentraliseerde vergrendeling vooraan
- Met verticaal verstelbare poten

Compleet geleverd met:

- 1 ingebouwde perslucht- of koudwaterslanghaspel, Ø 8 mm, lengte 10 m, art. 1900S 8x10
- 1 ingebouwde elektrische kabelhaspel, lengte 15 m, art. 1844 15-H05

47 kg

C45PRO ACT

€ P.O.A. 1 045000247

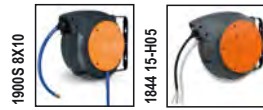

h	max
65 mm	25 kg
145 mm	30 kg

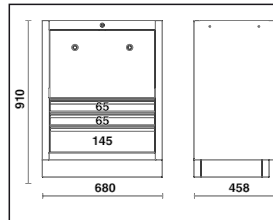
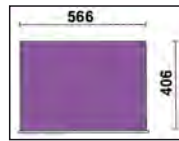

C45PRO TC

Vaste module voor haspels met 3 laden voor werkplaatsinrichting C45PRO, leeg

- 3 laden (566x406 mm) met kogelgelagerde geleiders
- Ladebodems beschermd door schuimrubberen matten
- Gecentraliseerde vergrendeling vooraan
- Met verticaal verstelbare poten

Geschikt voor 2 haspels, te kiezen uit:

- 2 perslucht- of koudwaterslanghaspels, 8 mm, lengte 10 m artikel 1900S 8x10
- 2 elektrische kabelhaspels, te kiezen uit de volgende artikelen: 1843 15-H05, 1844 10-H05, 1844 15-H05, 1844 15-H07, 1845 12-H05, 1846 10-H05, 1846 10-H07 en 1846 15-H05
- 1 perslucht- of koudwaterslanghaspel, 8 mm, lengte 10m artikel 1900S 8x10 en 1 kabelhaspel te kiezen uit bovenstaande artikelen

38 kg

C45PRO TC

€ P.O.A. 1 045000249

h	max
65 mm	25 kg
145 mm	30 kg

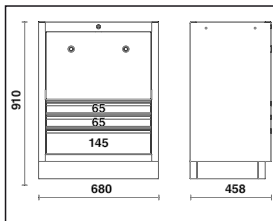
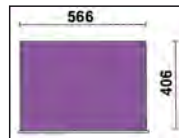

C45PRO T3

3-laags gereedschapswagen, voor werkplaatsinrichting combinatie C45PRO

- Twee bevestigingsmogelijkheden voor middelste plank
- 4 zwenkwielen, Ø 100 mm (een met rem)
- Statisch draagvermogen: 200 kg (verdeeld over 3 legborden)

19,2 kg

C45PRO T3

€ P.O.A. 1 045000250

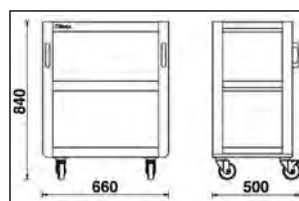

C45PRO SS

zijwandbeugels, smal type, voor werkplaatsinrichting C45PRO

- Afmetingen 1420x32,5x30 mm

1,5 kg



C45PRO SS

€ P.O.A. 1 045000333

C45PRO SL

zijwandbeugels, breed type, voor werkplaatsinrichting C45PRO

- Afmetingen 1420x65x30 mm

2 kg



C45PRO SL

€ P.O.A. 1 045000366

C45PRO PAS

gereedschapswandsysteem voor werkplaatsinrichting combinatie C45PRO

- Aluminium rolluik, verticaal verstelbaar, met slot
- Twee verwijderbare geperforeerde gereedschapspanelen
- Past bij een werkbank van 1,3 m lang

48,8 kg

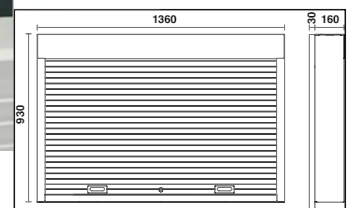

C45PRO PAS

€ P.O.A. 1 045000290

C45PRO PF

geperforeerd gereedschapspaneel voor werkplaatsuitrusting C45PRO

- Afmetingen 1052x614,5x24 mm

5,3 kg



C45PRO PF

€ P.O.A. 1 045000313

C45PRO PFE

geperforeerd gereedschapspaneel voor werkplaatsuitrusting C45PRO

- Afmetingen 1052x614,5x24 mm
- Kan worden voorzien van 1 stopcontact (niet inbegrepen)

5,3 kg



C45PRO PFE

€ P.O.A. 1 045000312



C45PRO MP

stalen plank voor geperforeerde gereedschapspanelen, voor werkplaatsuitrustingcombinatie C45PRO

Afmetingen: 614x160x80 mm

1,8 kg



C45PRO MP

€ P.O.A. 1 045000315

C45PRO CORNER/X

zelfdragende complete hoek voor werkplaatsuitrusting C45PRO

- Hangkast met gasveren, waardoor de deur makkelijker te openen en te sluiten is
- 2 geperforeerde gereedschapspanelen (1052x860)
- RVS hoekwerkblad (860x860 mm)
- Groot opbergvak in hoekkast
- Met verticaal verstelbare poten

94 kg



C45PRO CORNER/X

€ P.O.A. 1 045000401

Beta

C45PRO CORNER/W

zelfdragende complete hoek voor werkplaatsuitrusting C45PRO

- Hangkast met slot en gasveren, waardoor de deur makkelijker te openen en te sluiten is
- 2 geperforeerde gereedschapspanelen (1052x860 mm)
- Meerlaags houten hoekwerkblad (860x860 mm)
- Groot opbergvak in hoekkast
- Met verticaal verstelbare poten

93 kg

C45PRO CORNER/W

€ P.O.A. 1 045000411

C45PRO CAI/X

onderste hoekmodule voor werkplaatsinrichting C45PRO

- Hoekwerkblad van RVS gecoat MDF, 860x860 mm
- Vaste hoekmodule met groot opbergvak
- Met verticaal verstelbare poten

62 kg

C45PRO CAI/X

€ P.O.A. 1 045000412

C45PRO CAI/W

onderste hoekmodule voor werkplaatsuitrusting combinatie C45PRO

- Meerlaags houten hoekwerkblad (860x860 mm)
- Vaste hoekmodule met groot opbergvak
- Met verticaal verstelbare poten

56 kg

C45PRO CAI/W

€ P.O.A. 1 045000402

C45PRO PM

wandkast voor werkplaatsinrichting C45PRO

- Kastlengte: 680 mm
 - Met gasveren, waardoor het openen en sluiten van de deur makkelijker wordt
- Met slot

10 kg

C45PRO PM

€ P.O.A. 1 045000302

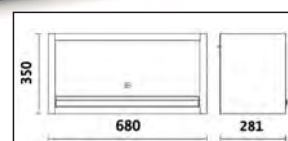

SSPE

Steun voor elektrisch gereedschap

- Enkel te gebruiken onder hangkast C45PRO PM (werkplaatsuitrusting C45PRO)
- Met 5 handige sleuven voor het opbergen van elektrisch gereedschap
- Afmetingen: 680 x 280 x 150 mm

5,4 kg



SSPE

€ 109,00 1 088880482

C45PRO PML

wandkast, lang, voor werkplaatsinrichting combinatie C45PRO

- Lengte wandkast: 1360 mm
- Met gasveren, waardoor het gemakkelijker is om de deur te openen en te sluiten
- Met slot

18 kg

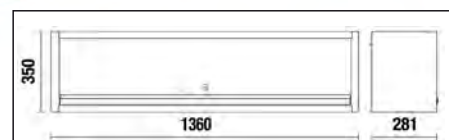

C45PRO PML

€ P.O.A. 1 045000303

C45PRO AS1

Plaaststalen enkeledeurs gereedschapskast met beugel, voor werkplaatsinrichting C45PRO

- 4 uitneembare, verticaal verstelbare planken
- handig opklapbaar kledingrek onder eerste plank
- met slot
- binnenafmetingen: 590x430 mm
- met verticaal verstelbare poten

57,5 kg

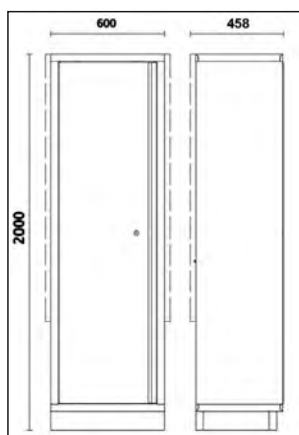

C45PRO AS1

€ P.O.A. 1 045000451

C45PRO A1/R600

binnenplank voor gereedschapskast C45PRO AS1

2,5 kg



C45PRO A1/R600

€ P.O.A. 1 045000466

C45PRO A1/RB600

binnenplank voor gereedschapskast C45PRO AS1, met kledingrek

2,6 kg



C45PRO A1/RB600

€ P.O.A. 1 045000467

C45PRO AS2

plaatstalen tweedeurs gereedschapskast met beugel, voor werkplaatsinrichting C45PRO

- 4 uitneembare, verticaal verstelbare planken
- Met slot
- Binnenafmetingen 910x430 mm
- Met verticaal verstelbare poten

80 kg

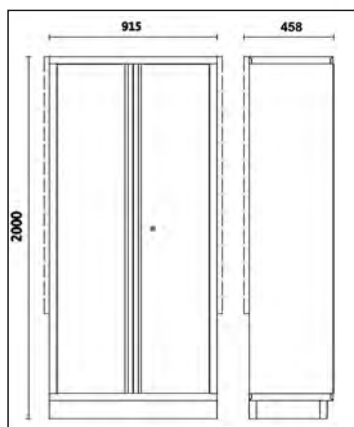

C45PRO AS2

€ P.O.A. 1 045000481

C45PRO A2/R915

3,7 kg



C45PROA2/R915

€ P.O.A. 1 045000496

C45STR

gekleurd tape voor werkplaats combinatie C45PRO







- maakt het mogelijk om de kleur van horizontale en verticale inzetstukken aan te passen in de werkplaatsinrichting C45PRO

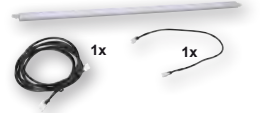

RAL2011
RAL9006
RAL3000
RAL5015
RAL1023
RAL6029

	L m	€	P.O.A.	1	045000911
C45STR-O/2011	30		P.O.A.	1	045000911
C45STR-G/9006	25		P.O.A.	1	045000912
C45STR-R/3000	25		P.O.A.	1	045000913
C45STR-B/5015	25		P.O.A.	1	045000914
C45STR-Y/1023	25		P.O.A.	1	045000915
C45STR-V/6029	25		P.O.A.	1	045000916

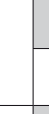
TOEBEHOREN RSC55 - RSC50 - C45PRO

		5000 RSC50/PLED-ST	5000 RSC50/PLED	5000 RSC50/ASL	5000 RSC50/CTR
					
	A	1x	-	1x	-
	B	-	1x	1x	1x
	A	1x	1x	1x	-
	B	-	2x	1x	1x
	A	1x	2x	1x	-
	B	-	3x	1x	1x

5000 RSC50/PLED

Aluminium profiel met LED -strip voor werkplaatsinrichting RSC50

Kan worden gemonteerd onder het werkblad of in de verlichtingsbakken hoek/recht om werkgebied goed te verlichten

Eigenschappen:

- 6.5W IP20 LED -strip; Lengte: 50 cm
- Wordt geleverd met 2 kabels (40cm en 170cm lang)
- Makkelijke bevestiging door middel van magneten

80 g

5000 RSC50/PLED € P.O.A. 1 050001714

5000 RSC50/PLED-ST

aluminium profiel met LED-strip en SOFT TOUCH schakelaar, voor werkplaatsinrichting RSC50

Kan worden gemonteerd onder het werkblad of in de verlichtingsbakken hoek/recht om werkgebied goed te verlichten

Eigenschappen:

- 6.5W IP20 LED -strip; Lengte: 50 cm
- SOFT TOUCH-schakelaar voor het inschakelen en aanpassen van het verlichtingsvermogen
- Wordt geleverd met 2 kabels (40cm en 170cm lang)
- Makkelijke bevestiging door middel van magneten

80 g

5000 RSC50/PLED-ST € P.O.A. 1 050001715

5000 RSC50/ASL

Voeding voor LED -strip voor werkplaatsinrichting RSC50

Kenmerken:

- 24VDC 22W voeding
- Kan stroom leveren aan maximaal 3x 6.5W LED -strips

200 g

5000 RSC50/ASL € P.O.A. 1 050001716



5000 RSC50/CTR

LED strip controller, met RF afstandsbediening voor werkplaatsinrichting combinatie RSC50

Alleen te gebruiken met ledstrip artikel 5000 RSC50/ PLED

Inhoud pakket:
1 mini-ontvanger
1 draadloze RF afstandsbediening

Specificaties mini-ontvanger:
Ingangsspanning: 5V -24VDC
Nominale uitgangsstroom: 5A
Piek uitgangsstroom: 12A
Bedrijfstemperatuur: -20 ÷ +35 °C

Specificaties van RF-afstandsbediening:
Aan / uit knop
BRIGHT +/- knop: maakt handmatige aanpassing van het verlichtingsvermogen mogelijk
Knop 25%/50%/100%: maakt automatische aanpassing van het verlichtingsvermogen mogelijk
Batterij: 3V CR2025 (inbegrepen)
Afmetingen: 86x40x7 mm

Geïntegreerde functies:
• Geheugen
• Modus (handmatige/automatische helderheid)
• Helderheidsaanpassing



20 g

5000 RSC50/CTR € P.O.A. 1 050001721

CPMB/3C

Werkbank accessoires, bakken met 3 lades

- Buitenframe van PP
- Lades voor kleine onderdelen van PET
- Stapelbaar

Specificaties lades:
• Binnenafmetingen lade: 160x107x105h mm
• Onbreekbaar
• Transparantie van glaseffect onveranderd in de loop van de tijd
• Krasbestendig
• Bestand tegen olie, zuren en agressieve chemicaliën
• Ook geschikt voor gebruik in voedingsmiddelen



2 kg

CPMB/3C € 54,00 1 088880443

KIT 6VC/3C

set van 6 uitneembare trays voor item CPMB/3C

1,1 kg



6x



KIT 6VC/3C € 29,50 1 088880453

CPMB/5C

Werkbank accessoires, bakken met 5 lades

- Buitenframe van PP
- Lades voor kleine onderdelen van PET
- Stapelbaar

Specificaties lades:

- Binnenafmetingen lade: 90x86x62h mm
- Onbreekbaar
- Transparantie van glaseffect onveranderd in de loop van de tijd
- Krasbestendig
- Bestand tegen olie, zuren en agressieve chemicaliën
- Ook geschikt voor gebruik in voedingsmiddelen

1,5 kg

CPMB/5C

€ 64,50 1 088880445



KIT 10VC/5C

Set van 10 verwijderbare lades item CPMB/5C

800 g

KIT 10VC/5C

€ 27,50 1 088880455



10x



PM/5C

5-vaks magazijnbakjes, vervaardigd uit kunststof met wandhouder

- binnenafmetingen bakje: 95x120 mm
- toepasbaar met gereedschapswandsystemen C45PRO en RSC55

1,8 kg

PM/5C

€ 121,00 1 088880450



165
120
600



PM/6C

6-vaks magazijnbakjes, vervaardigd uit kunststof met wandhouder

- binnenafmetingen bakje: 80x60 mm
- toepasbaar met gereedschapswandsystemen C45PRO en RSC55

970 g

PM/6C

€ 95,00 1 088880440



115
95
600



CP

Wand spuitbushouder, vervaardigd uit staal

- Kan gemonteerd worden op de gereedschapspanelen

530 g

CP

€ 129,50 1 088880470

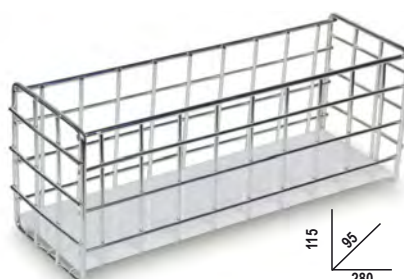

115
95
280



SPC

computer muurbeugel

- Past bij gereedschapswandsystemen RSC55 en C45PRO
- Afmetingen 398x243x138 mm

1,5 kg



SPC

€ 89,50 1 088880480

SP5S

wandsteun met 5 compartimenten

- Gemaakt van plaatstaal
- 5 gereedschapsvakken variërend in hoogte
- Afmetingen: 260x60x290 mm

1 kg



SP5S

€ 135,00 1 088880475



GEREEDSCHAPWAGENS

LOSSE GEREEDSCHAPPEN

INLEGBAKKEN VOOR LADEN

RSC24A/6	RSC24A/7	RSC24A/8	RSC24A/9
C37/6	C37/7	C37/8	C37/9
C39/6	C39/7	C39/8	C39/9

		Aantal	RSC22	RSC23	RSC23C	RSC23T	RSC24/5	RSC24/6	RSC24/7	RSC24A/7	RSC24/8	RSC24A/8	RSC24AXL/9	C25	C27S	RSC28	C30M	
zonder supports	5902MT	Grondverzet	106	☐ 518	☐ 518	☐ 518												
	5902MT/AS	Grondverzet	99	☐ 519	☐ 519	☐ 519												
	5902VI	Voor industrieel onderhoud	107	☐ 481	☐ 481		☐ 481							☐ 481	☐ 481			
	5904VG/3	Automobielen	132					☐ 522	☐ 522	☐ 522	☐ 522							
	5905VG/1	Automobielen	94											☐ 525				
	5905VG/2	Automobielen	118											☐ 526				
	5910VI/3	Voor industrieel onderhoud	297														☐ 485	
	5954VG	Automobielen	138															
	5954VI	Voor industrieel onderhoud	133															
	5957U-P	Universeel gebruik	133															
met supports	5957VG	Automobielen	174															
	5957VI	Voor industrieel onderhoud	162															
	5958U	Universeel gebruik	85															
	5904VG/2M	Automobielen	170				☐ 520	☐ 520	☐ 520	☐ 520	☐ 520	☐ 520				☐ 520		
	5904VU/1M	Universeel gebruik	90				☐ 490	☐ 490	☐ 490	☐ 490	☐ 490	☐ 490				☐ 490		
	5904VU/2M	Universeel gebruik	144				☐ 491	☐ 491	☐ 491	☐ 491	☐ 491	☐ 491				☐ 491		
	5927VU/M	Universeel gebruik	108	☐ 501	☐ 501	☐ 501									☐ 501			
	5935ET/1MB	Electrotechnical	96															
	5935VG/1MB	Automobielen	98															
	5935VI/2MB	Voor industrieel onderhoud	133															
specifiek ontworpen zachte inlegbakken	5945VUM	Universeel gebruik	231															
	5988H/7M	Automobielen	333								☐ 508	☐ 508				☐ 508		
	5988L/4M	Automobielen	273					☐ 509	☐ 509	☐ 509	☐ 509	☐ 509						
	5980U/BIKE-M	Fietsonderhoud	106								☐ 507	☐ 507				☐ 507		
	5988U6/M	Universeel gebruik	214							☐ 510	☐ 510	☐ 510				☐ 510		
	5988U/7M	Universeel gebruik	215				☐ 497	☐ 497	☐ 497	☐ 497	☐ 497	☐ 497				☐ 497		
	5988VHB-MQ	Electrotechnical	66				☐ 514	☐ 514	☐ 514	☐ 514	☐ 514	☐ 514				☐ 514		
	5989 VEM	Automobielen	66				☐ 517	☐ 517	☐ 517	☐ 517	☐ 517	☐ 517				☐ 517		
	zachte inlegbakken	5904VI/1T	Voor industrieel onderhoud	98				☐ 481	☐ 481	☐ 481	☐ 481	☐ 481	☐ 481				☐ 481	
		5904VI/2T	Voor industrieel onderhoud	153				☐ 482			☐ 482	☐ 482	☐ 482				☐ 482	
5904VI/3T		Voor industrieel onderhoud	142								☐ 483	☐ 483				☐ 483		
5904VG/2T		Automobielen	99				☐ 521	☐ 521	☐ 521	☐ 521	☐ 521	☐ 521				☐ 521		
5904VG/3T		Automobielen	102				☐ 523	☐ 523	☐ 523	☐ 523	☐ 523	☐ 523				☐ 523		
5904VG/5T		Automobielen	153				☐ 524		☐ 524	☐ 524	☐ 524	☐ 524				☐ 524		
5904VU/2T		Universeel gebruik	104				☐ 492	☐ 492	☐ 492	☐ 492	☐ 492	☐ 492				☐ 492		
5904VU/3T		Universeel gebruik	146				☐ 493	☐ 493	☐ 493	☐ 493	☐ 493	☐ 493				☐ 493		
5904VU/4T		Universeel gebruik	197				☐ 494	☐ 494	☐ 494	☐ 494	☐ 494	☐ 494						
5908VG/2T		Automobielen	214														☐ 527	
5908VI/2T		Voor industrieel onderhoud	232								☐ 484	☐ 484				☐ 484		
5908VU/2T		Universeel gebruik	161				☐ 495		☐ 495	☐ 495	☐ 495	☐ 495				☐ 495		
5910VI/3T		Voor industrieel onderhoud	261														☐ 486	
5938U/2T		Universeel gebruik	210															

GEREEDSCHAPWAGENS

LOSSE GEREEDSCHAPPEN

INLEGBAKKEN VOOR LADEN

		Aantal	C35	C38	C39MD C39SM	C39T	C45PRO	RSC51	C54S RSC55C	RSC55	RSC55PS	RSC55PSE	RSC50	C57SA C57SB C57SP	C58P	C45PRO PAS	C59A C59C	C59B	
zonder supports	5902MT	Grondverzet	106			☐ 518													
	5902MT/AS	Grondverzet	99			☐ 519													
	5902VI	Voor industrieel onderhoud	107																
	5904VG/3	Automobielen	132							☐ 522			☐ 522				☐ 522	☐ 522	
	5905VG/1	Automobielen	94																
	5905VG/2	Automobielen	118																
	5910VI/3	Voor industrieel onderhoud	297																
	5954VG	Automobielen	138							☐ 531									
	5954VI	Voor industrieel onderhoud	133							☐ 489	☐ 489								
	5957U-P	Universeel gebruik	133										☐ 503	☐ 503	☐ 503				
met supports	5957VG	Automobielen	174									☐ 532		☐ 532					
	5957VI	Voor industrieel onderhoud	162											☐ 488					
	5958U	Universeel gebruik	85				☐ 504			☐ 504	☐ 504				☐ 504				
	5904VG/2M	Automobielen	170			☐ 520	☐ 520			☐ 520							☐ 520	☐ 520	
5904VU/1M	Universeel gebruik	90			☐ 490	☐ 490		☐ 490	☐ 490							☐ 490	☐ 490		
5904VU/2M	Universeel gebruik	144			☐ 491	☐ 491			☐ 491							☐ 491	☐ 491		
5927VU/M	Universeel gebruik	108																	
5935ET/1MB	Electrotechnical	96	☐ 511																
5935VG/1MB	Automobielen	98	☐ 528																
5935VI/2MB	Voor industrieel onderhoud	133	☐ 487																
5945VUM	Universeel gebruik	231		☐ 530			☐ 530												
5988H/7M	Automobielen	333								☐ 508								☐ 469	
5988L/4M	Automobielen	273			☐ 470	☐ 470				☐ 470						☐ 470	☐ 470		
5980U/BIKE-M	Fietsonderhoud	106																	
5988U6/M	Universeel gebruik	214			☐ 510					☐ 510								☐ 510	
5988U/7M	Universeel gebruik	215			☐ 497					☐ 497						☐ 497	☐ 497		
5988VHB-MQ	Electrotechnical	66			☐ 514	☐ 514		☐ 514	☐ 514							☐ 514	☐ 514		
5989 VEM	Automobielen	66																	
zachte inlegbakken	5904VI/1T	Voor industrieel onderhoud	98			☐ 481	☐ 481		☐ 481	☐ 481							☐ 481	☐ 481	
	5904VI/2T	Voor industrieel onderhoud	153			☐ 482				☐ 482							☐ 482	☐ 482	
	5904VI/3T	Voor industrieel onderhoud	142			☐ 483				☐ 483								☐ 483	
	5904VG/2T	Automobielen	99			☐ 521	☐ 521		☐ 521	☐ 521							☐ 521	☐ 521	
	5904VG/3T	Automobielen	102			☐ 523	☐ 523			☐ 523							☐ 523	☐ 523	
	5904VG/5T	Automobielen	153			☐ 524				☐ 524							☐ 524	☐ 524	
	5904VU/2T	Universeel gebruik	104			☐ 492	☐ 492			☐ 492							☐ 492	☐ 492	
	5904VU/3T	Universeel gebruik	146			☐ 493	☐ 493			☐ 493							☐ 493	☐ 493	
	5904VU/4T	Universeel gebruik	197			☐ 494	☐ 494			☐ 494							☐ 494	☐ 494	
	5908VG/2T	Automobielen	214																
	5908VI/2T	Voor industrieel onderhoud	232																☐ 484
	5908VU/2T	Universeel gebruik	161			☐ 495				☐ 495							☐ 495	☐ 495	
	5910VI/3T	Voor industrieel onderhoud	261																
	5938U/2T	Universeel gebruik	210		☐ 502														

5902VI

Assortiment van 107 gereedschappen

► Industrieel onderhoud

Aantal/Omschrijving

- 6 pendrijvers Ø 2 - 3 - 4 - 5 - 6 - 8 mm
- 1 centerpunt Ø 3 mm
- 1 koudbeitels, geprofileerd model 200 mm
- 26 Ringsteeksleutels 6+32 mm
- 12 dubbele steeksleutels 6x7 - 8x9 - 10x11 - 12x13 - 14x15 - 16x17 - 18x19 - 20x22 - 21x23 - 24x26 - 25x28 - 30x32 mm
- 9 haakse inbussleutels Ø 1,5 - 2 - 2,5 - 3 - 4 - 5 - 6 - 8 - 10 mm
- 1 Verstelbare moersleutel 300 mm
- 13 1/2" zeskant dopsleutels op dophouder Ø 10+22 mm
- 1 1/2" verlengstuk 125 mm
- 1 1/2" verlengstuk 255 mm
- 1 1/2" cardangewricht
- 1 1/2" wringstaaf
- 1 1/2" omschakelbare ratel Ⓞ
- 1 Waterpomplang met Slip-proof PVC 250 mm
- 1 Verstelbare griptang 240 mm
- 1 Zijknijptangen, twee componenten handgreep, industriële afwerking ∇ 160 mm
- 1 hefboomblijkschaar rechte bekken 250 mm
- 1 elektricienschaar, rechte bladen
- 1 Zware combinatietangen, twee componenten handgreep, industriële afwerking \equiv 180 mm
- 1 Telefoontangen, extra lange halfronde gegroefde bekken, twee componenten handgreep, industriële afwerking \bullet 160 mm
- 8 Schroevendraaiers voor sleufschroeven \bullet 2,5x50 - 3x75 - 3,5x100 - 4x125 - 5,5x125 - 6,5x150 - 8x200 - 10x200 mm
- 4 Schroevendraaiers voor Phillips® kruiskop schroeven \oplus PH0x60 - PH1x80 - PH2x100 - PH3x150 mm
- 1 bankhamer 500 g
- 1 terugslagvrije hamer Ø 40 mm
- 1 kraspen
- 1 rolbandmaat 5 m
- 1 voelermaat
- 5 5-delig set halfzoeten vijlen met handgreep 200 mm
- 1 zaagbeugel
- 1 metalen oliekan met pomp, 300 cc
- 1 afbreekmes, plat model
- 1 Magnetische flexibele werkklamp met ultra heldere LEDs, vervaardigd uit stevig geanodiseerd aluminium, Lichtsterkte tot 500 lumen

Beta Nr.

- 31
- 32
- 35
- 42/S26
- 55/S12
- 96N/SC9
- 111E
- 920A/SB13
- 920/21
- 920/22
- 920/25
- 920/42
- 920/55
- 1048N
- 1052
- 1084GBM
- 1122
- 1128BMX
- 1150GBM
- 1166GBM
- 1260
- 1262
- 1370
- 1392
- 1688A
- 1692
- 1708/20
- 1719BMA...S5
- 1726BM
- 1751N
- 1771BM
- 1837F

€ 1.810,00 059021060

Assortiment aanbevolen in combinatie met RSC22 - RSC23 - RSC23T - C25 - C27S

5904VI/1T

Assortiment van 98 gereedschappen in voorgevormde ABS inlegbakken

► Industrieel onderhoud

Aantal/Omschrijving

- 19 1/2" dopsleutels, zeskant Ø 10+24 - 26 - 27 - 30 - 32 mm
- 5 1/2" schroevendraaiers voor inbusschroeven Ø 5 - 6 - 8 - 10 - 12 mm
- 1 1/2" verlengstuk 125 mm
- 1 1/2" verlengstuk 255 mm
- 1 1/2" cardangewricht
- 1 1/2" wringstaaf
- 1 1/2" omschakelbare ratel Ⓞ
- 16 ringsteeksleutels 6+21 mm
- 5 ringsteeksleutels 22-24-27-30-32 mm
- 1 Waterpomplang met Slip-proof PVC 250 mm
- 1 Verstelbare griptang 240 mm
- 1 Zijknijptangen, zware uitvoering ∇ 160 mm
- 1 Combinatietangen \equiv 180 mm
- 1 Telefoontang, lange platte gegroefde bekken \bullet 160 mm
- 1 borgveertangen, inwendig rechte punten \circ 180 mm
- 1 borgveertangen, inwendig 90° gebogen punten \circ 170 mm
- 1 borgveertangen, uitwendig rechte punten \bullet 175 mm
- 1 borgveertangen, uitwendig 90° gebogen punten \bullet 175 mm
- 2 koudbeitels, geprofileerd model 100 - 200 mm
- 5 halfzoete vijlen 200 mm
- 1 bankhamer 300 g
- 1 kunststof hamer Ø 35 mm
- 8 dubbele steeksleutels 6x7 - 8x9 - 10x11 - 12x13 - 14x15 - 16x17 - 18x19 - 20x22 mm
- 9 haakse inbussleutels Ø 1,5 - 2 - 2,5 - 3 - 4 - 5 - 6 - 8 - 10 mm
- 3 Schroevendraaiers voor sleufschroeven \bullet 3x75 - 4x100 - 5,5x150 - 6,5x150 mm
- 3 Schroevendraaiers voor Phillips® kruiskop schroeven \oplus PH0x60 - PH1x80 - PH2x100 mm
- 6 inbus T-sleutels met zeskant profiel op drie zijden 2,5 - 3 - 4 - 5 - 6 - 8 mm

- | Beta Nr. | TR |
|-------------|------|
| 920A | T80 |
| 920ME | T80 |
| 920/21 | T80 |
| 920/22 | T80 |
| 920/25 | T80 |
| 920/42 | T80 |
| 920/55 | T80 |
| 42 | T05 |
| 42 | T06 |
| 1048N | T153 |
| 1052 | T153 |
| 1084 | T138 |
| 1150 | T138 |
| 1166 | T138 |
| 1032 | T145 |
| 1034 | T145 |
| 1036 | T145 |
| 1038 | T145 |
| 35 | T234 |
| 1719BMA8/S5 | T236 |
| 1370 | T234 |
| 1390 | T234 |
| 55 | T33 |
| 96/SC9 | T33 |
| 1260 | T208 |
| 1262 | T208 |
| 951 | T68 |

€ 1.625,00 059041161

Assortiment aanbevolen in combinatie met RSC51 - RSC23T - RSC24 - RSC24L/7 - RSC24L-CAB
RSC24A - RSC24AXL - RSC28 - C37 - C39 met 6 - 7 - 8 laden - C39MD - C39SM - C39T - RSC50 - RSC55 - C59

5904VI/2T

Assortiment van 153 gereedschappen in voorgevormde ABS inlegbakken

► Industrieel onderhoud

Aantal/Omschrijving

- 16 ringsteeksleutels 6÷21 mm
- 5 ringsteeksleutels 22 - 24 - 27 - 30 - 32 mm
- 5 pendrijvers Ø 2 - 3 - 4 - 5 - 6 mm
- 1 centerpunt Ø 4 mm
- 12 dubbele steeksleutels 6x7 - 8x9 - 10x11 - 12x13 - 14x15 - 16x17
18x19 - 20x22 - 21x23 - 24x26 - 27x29 - 30x32 mm
- 9 haakse inbussleutels ⌀ 1,5 - 2 - 2,5 - 3 - 4 - 5 - 6 - 8 - 10 mm
- 7 ringsleutels, diepgebogen 6÷29 mm
- 19 1/2" dopsleutels, zeskant ⌀ 10÷24 - 26 - 27 - 30 - 32 mm
- 1 1/2" verlengstuk 125 mm
- 1 1/2" verlengstuk 255 mm
- 1 1/2" cardangewricht
- 1 1/2" wringstaaf
- 1 1/2" omschakelbare ratel Ⓢ
- 13 1/4" dopsleutels, zeskant ⌀ 4÷14 mm
- 6 1/4" schroevendraaiers voor inbusschroeven ⌀ 2,5÷8 mm
- 1 1/4" verlengstuk 50 mm
- 1 1/4" verlengstuk 150 mm
- 1 1/4" cardangewricht
- 1 1/4" steekhecht
- 1 1/4" wringstaaf met schuifstuk
- 1 1/4" omschakelbare ratel Ⓢ
- 9 Schroevendraaiers voor sleufschroeven ● 3x75 - 3x100 - 4x100 - 4x150 - 5,5x100 - 5,5x150
- 6,5x150 - 8x150 - 10x200 mm
- 2 schroevendraaier voor sleufschroeven extra korte uitvoering ● 4x30 - 6,5x30 mm
- 7 Schroevendraaiers voor Phillips® kruiskop schroeven ● PH0x60 - PH0x100 - PH1x80 - PH1x120 - PH2x100 - PH2x150 - PH3x150 mm
- 2 schroevendraaiers voor Phillips® kruiskopschroeven extra korte uitvoering
● PH1x30 - PH2x30 mm
- 1 Waterpompfang met Slip-proof PVC 250 mm
- 1 Verstelbare griptang 240 mm
- 1 Zijknijptangen, zware uitvoering ⚡ 160 mm
- 1 Telefoontang, lange platte gegroefde bekken ● 160 mm
- 1 Combinatietangen = 180 mm
- 1 borgveertangen, inwendig rechte punten ⌀ 180 mm
- 1 borgveertangen, inwendig 90° gebogen punten ⌀ 170 mm
- 1 borgveertangen, uitwendig rechte punten ● 175 mm
- 1 borgveertangen, uitwendig 90° gebogen punten ● 175 mm
- 6 inbus T-sleutels met zeskant profiel op drie zijden 2,5 - 3 - 4 - 5 - 6 - 8 mm
- 5 halfzoete vijlen 200 mm
- 2 koudbeitels, geprofileerd model 100 - 200 mm
- 1 bankhamer 300 g
- 1 kunststof hamer Ø 35 mm
- 1 blindklingtang
- 100 aluminium nagels 2,9x6 mm
- 100 aluminium nagels 3,2x8 mm
- 100 aluminium nagels 3,8x10 mm
- 100 aluminium nagels 4x12 mm
- 100 aluminium nagels 4,8x12 mm
- 1 rolbandmaat
- 1 mini zaagbeugel
- 1 Reserve afbreekmesses 18 mm, verpakt per 10 stuks, voor model 1771, 1771BM, 1771HD
- 1 afbreekmes, plat model

Beta Nr.	TR
42	T05
42	T06
31	T31
32	T31
55	T31
96N/SC9	T31
90	T40
920A	T83
920/21	T83
920/22	T83
920/25	T83
920/42	T83
920/55	T83
900	T91
900ME	T91
900/20	T91
900/21	T91
900/25	T91
900BG/30	T91
900/42	T91
900/55	T91
1260	T167
1260N	T167
1262	T168
1262N	T168
1048N	T153
1052	T153
1084	T138
1166	T138
1150	T138
1032	T145
1034	T145
1036	T145
1038	T145
951	T68
1719BMA8/S5	T236
35	T234
1370	T234
1390	T234
1741B	T281
1741RV...K	T281
1741RV...K	T281
1741RV...K	T281
1741RV...K	T281
1741RV...K	T281
1692	T294
1725CR	T294
1771RL	T294
1771	T294



T05 T06 T31



T40 T83 T91



T167 T168



T153 T138 T145 T68



T236 T234 T281 T294

€

5904VI/2T

2.335,00 059041164

Assortiment aanbevolen in combinatie met RSC23T - RSC24 met 7 - 8 laden - RSC24A met 7 - 8 laden - RSC24AXL - RSC24LJ7 - RSC24L-CAB - RSC28 - C37 met 7 - 8 laden - C39 met 7 - 8 laden - C39MD - C39SM - C59 - RSC50 - RSC55

5904VI/3T

Assortiment van 142 gereedschappen in voorgevormde ABS inlegbakken

► Industrieel onderhoud

Aantal/Omschrijving

- 16 ringsteeksleutels 6÷21 mm
- 5 ringsteeksleutels 22 - 24 - 27 - 30 - 32 mm
- 5 pendrijvers Ø 2 - 3 - 4 - 5 - 6 mm
- 1 centerpunt Ø 4 mm
- 12 dubbele steeksleutels 6x7 - 8x9 - 10x11 - 12x13 - 14x15 - 16x17 - 18x19 - 20x22 - 21x23 - 24x26 - 27x29 - 30x32 mm
- 9 haakse inbussleutels ⌀ 1,5 - 2 - 2,5 - 3 - 4 - 5 - 6 - 8 - 10 mm
- 9 Schroevendraaiers voor sleuvschroeven ● 3x75 - 3,5x100 - 4x100 - 4x150 - 5,5x100 - 5,5x150 - 6,5x150 - 8x150 - 10x200 mm
- 2 schroevendraaier voor sleuvschroeven extra korte uitvoering ● 4x30 - 6,5x30 mm
- 6 Schroevendraaiers voor Phillips® kruiskop schroeven ⚙ PH0x60 - PH0x100 - PH1x80 - PH1x120 - PH2x100 - PH2x150 mm
- 7 schroevendraaiers voor Torx® schroeven ⚙ T6-T7-T8-T9-T10-T15-T20
- 5 1/2" schroevendraaierdoppen voor inbusschroeven ⌀ 5 - 6 - 8 - 10 - 12 mm
- 1 1/2" verlengstuk 125 mm
- 1 1/2" verlengstuk 255 mm
- 1 1/2" cardangewricht
- 1 1/2" wringstaaf
- 1 1/2" omschakelbare ratel ⚙
- 19 1/2" dopsleutels, zeskant ⌀ 10÷24 - 26 - 27 - 30 - 32 mm
- 8 Pijpsleutels, twaalfkant, zware uitvoering 6x7 - 8x9 - 10x11 - 12x13 - 14x15 - 16x17 - 18x19 - 20x22 mm
- 1 wringstaven voor pijpsleutels
- 1 wringstaven voor pijpsleutels
- 6 inbus T-sleutels met zeskant profiel op drie zijden 2,5 - 3 - 4 - 5 - 6 - 8 mm
- 1 combinatietang hoogverchroomd = 180 mm
- 1 Telefoontang, lange halfronde gegroefde bekken ● 160 mm
- 1 Zijkniptangen, zware uitvoering ⚔ 160 mm
- 1 Waterpomptang met Slip-proof PVC 250 mm
- 1 Verstelbare griptang 240 mm
- 1 borgveertangen, inwendig rechte punten ⌀ 180 mm
- 1 borgveertangen, inwendig 90° gebogen punten ⌀ 170 mm
- 1 borgveertangen, uitwendig rechte punten ● 175 mm
- 1 borgveertangen, uitwendig 90° gebogen punten ● 175 mm
- 1 borgveertangen, inwendig rechte punten ⌀ 140 mm
- 1 borgveertangen, inwendig 90° gebogen punten ⌀ 225 mm
- 1 borgveertangen, uitwendig rechte punten ● 140 mm
- 1 borgveertangen, uitwendig 90° gebogen punten ● 225 mm
- 1 bankhamer 400 g
- 1 kunststof hamer Ø 35 mm
- 1 halfzoete vijlen 200 mm
- 1 halfzoete vijlen 200 mm
- 1 halfzoete vijlen 200 mm
- 1 digitale schuifmaat, uitlezing tot 0,01mm
- 1 flexibele lineaal 300 mm
- 1 rolbandmaten 5 m
- 1 blindklinktang 250 mm
- 100 aluminium nagels 2,9x6 mm
- 100 aluminium nagels 3,2x8 mm
- 100 aluminium nagels 3,8x10 mm
- 100 aluminium nagels 4x12 mm
- 100 aluminium nagels 4,8x12 mm
- 1 blikshaar 250 mm
- 1 elektriciens schaar rechte bladen
- 1 zaagbeugel
- (5) zaagbladen voor zaagbeugels
- 1 metalen oliekan met pomp, 200 cc
- 1 kunststof inleg

Beta Nr.	TR
42	T05
42	T06
31	T31
32	T31
55	T31
96N/SC9	T31
1260	T167
1260N	T167
1262	T202
1267TX	T205
920ME	T80
920/21	T80
920/22	T80
920/25	T80
920/42	T80
920/55	T80
920A	T80
930	T73
940/1	T73
940/2	T73
951	T68
1150BM	T137
1166BM	T137
1084BM	T137
1048N	T153
1052	T153
1032	T145
1034	T145
1036	T145
1038	T145
1032	T146
1034	T146
1036	T146
1038	T146
1370	T231
1390	T231
1719BMA8/T	T231
1719BMA8/P	T231
1719BMA8/M	T231
1651DGTB	T297
1682	T297
1691BM	T297
1741B	T281
1741RV..K	T281
1741RV..K	T281
1741RV..K	T281
1741RV..K	T281
1741RV..K	T281
1112	T279
1128BM	T279
1726	T279
1728BM	T279
1751N	T279
VP6	VP6



T05 T06 T31



T167 T202 T205



T80 T73 T68



T137 T153 T145 T146



T231 T297 T281



T279 VP6

€

5904VI/3T 2.690,00 059041168

Assortiment aanbevolen in combinatie met RSC24 met 8 laden - RSRSC24A met 8 laden - RSC24AXL met 8-9 laden
RSC28 - C37 met 8 laden - C39 met 8 laden - C39MD - C39SM - RSC50 - RSC55 - C59B

5908VI/2T

Assortiment van 232 gereedschappen in voorgevormde ABS inlegbakken

► Industrial maintenance

Aantal/Omschrijving

- 5 1/2" schroevendraaiers voor inbusschroeven \odot 5 - 6 - 8 - 10 - 12 mm
- 1 1/2" verlengstuk 125 mm
- 1 1/2" verlengstuk 255 mm
- 1 1/2" cardangewricht
- 1 1/2" wringstaaf
- 1 1/2" omschakelbare ratel \oplus
- 19 1/2" dopsleutels, zeskant \odot 10+24 - 26 - 27 - 30 - 32 mm
- 16 ringsteeksleutels 6+21 mm
- 5 ringsteeksleutels 22 - 24 - 27 - 30 - 32 mm
- 13 1/4" dopsleutels, zeskant \odot 4+14 mm
- 6 1/4" schroevendraaiers voor inbusschroeven \odot 2,5 - 3 - 4 - 5 - 6 - 8 mm
- 1 1/4" verlengstuk 50 mm
- 1 1/4" verlengstuk 150 mm
- 1 1/4" steekhecht
- 1 1/4" cardangewricht
- 1 1/4" wringstaaf met schuifstuk
- 1 1/4" omschakelbare ratel \oplus
- 6 inbus T-sleutels met zeskant profiel op drie zijden 2,5 - 3 - 4 - 5 - 6 - 8 mm
- 7 ringsleutels, diepgebogen 6x7-8x9-10x11-12x13-14x15-16x17-18x19 mm
- 5 ringsleutels, diepgebogen 20x22 - 21x23 - 24x26 - 25x28 - 27x29 mm
- 7 Schroevendraaiers voor sleufschroeven \bullet 2,5x50 - 3x75 - 3,5x100 - 4x125 - 5,5x100 - 5,5x150 - 6,5x150 mm
- 6 Schroevendraaiers voor Phillips® kruiskop schroeven \oplus PH0x60 - PH0x100 - PH1x80 - PH1x120 - PH2x100 - PH2x150 mm
- 3 Schroevendraaiers voor sleufschroeven \bullet 8x200 - 10x150 - 10x200 mm
- 2 schroevendraaiers voor sleufschroeven extra korte uitvoering \bullet 4x30 - 6,5x30 mm
- 2 Schroevendraaiers voor Phillips® kruiskop schroeven \oplus PH3x150 - PH4x200 mm
- 2 schroevendraaiers voor Phillips® kruiskopschroeven extra korte uitvoering \oplus PH1x30 - PH2x30 mm
- 2 koudbeitels, geprofileerd model 100 - 200 mm
- 1 bankhamer 300 g
- 1 kunststof hamer \varnothing 35 mm
- 1 blindklinktang 250 mm
- 100 aluminium nagels 2,9x6 mm
- 100 aluminium nagels 3,2x8 mm
- 100 aluminium nagels 3,8x10 mm
- 100 aluminium nagels 4x12 mm
- 100 aluminium nagels 4,8x12 mm
- 1 Waterpomptang met Slip-proof PVC 250 mm
- 1 Verstelbare griptang 240 mm
- 5 5-delig set halfzoeten vijlen met handgreep 200 mm
- 1 borgveertangen, inwendig rechte punten \odot 180 mm
- 1 borgveertangen, inwendig 90° gebogen punten \odot 170 mm
- 1 borgveertangen, uitwendig rechte punten \bullet 175 mm
- 1 borgveertangen, uitwendig 90° gebogen punten \bullet 175 mm
- 1 combinatietang hoogverchroomd \equiv 180 mm
- 1 Telefoontang, lange halfronde gegroefde bekken \bullet 160 mm
- 1 Zijkniptangen, zware uitvoering ∇ 160 mm
- 5 pendrijvers \varnothing 2 - 3 - 4 - 5 - 6 mm
- 1 centerpunt \varnothing 4 mm
- 12 dubbele steeksleutels 6x7 - 8x9 - 10x11 - 12x13 - 14x15 - 16x17 - 18x19 - 20x22 - 21x23 - 24x26 - 27x29 - 30x32 mm
- 9 haakse inbussleutels \odot 1,5 - 2 - 2,5 - 3 - 4 - 5 - 6 - 8 - 10 mm
- 1 blikchaar 250 mm
- 1 elektriciens schaar rechte bladen
- 1 zaagbeugel
- 5 zaagbladen voor zaagbeugels
- 1 metalen oliekan met pomp, 200 cc
- 1 kunststof inleg
- 1 verstelbaar wringijzer M3+M12
- 1 verstelbaar wringijzer M5+M21
- 1 korte taphouder met ratel 2,0+5,0 mm (M3+M8)
- 1 korte taphouder met ratel 4,6+8,0 mm (M5+M12)
- 1 snijplaatouder 25,4 mm
- 1 snijplaatouder 38,1 mm
- 1 schroefdraadmeter 0,25+6 W 62+4x1"
- 26 handtappen, grove spoed M3 - 4 - 5 - 6 - 7 - 8 - 9 - 10 - 12 - 14 - 16 - 18 - 20
- 14 handtappen, fijne spoed M6x0,75 - M8x1 - M10x1,25 - M12x1,5 - M14x1,5 - M16x1,5 - M18x1,5
- 7 snijplaten, grove draad M3 - 4 - 5 - 6 - 7 - 8 - 9
- 6 snijplaten, grove draad M10 - 12 - 14 - 16 - 18 - 20
- 2 snijplaten, fijne draad M6x0,75 - M8x0,75
- 5 snijplaten, fijne draad M10x1,25 - M12x1,5 - M14x1,5 - M16x1,5 - M18x1,5

Beta Nr.	TR
920ME	T80
920/21	T80
920/22	T80
920/25	T80
920/42	T80
920/55	T80
920A	T80
42	T05
42	T06
900	T91
900ME	T91
900/20	T91
900/21	T91
900BG/30	T91
900/25	T91
900/42	T91
900/55	T91
951	T68
90	T40
90	T41
1260	T199
1262	T202
1260	T201
1260N	T201
1262	T204
1262N	T204
35	T234
1370	T234
1390	T234
1741B	T281
1741RV...K	T281
1741RV...K	T281
1741RV...K	T281
1741RV...K	T281
1741RV...K	T281
1048N	T153
1052	T153
1719BMA...S5	T236
1032	T145
1034	T145
1036	T145
1038	T145
1150BM	T137
1166BM	T137
1084BM	T137
31	T31
32	T31
55	T31
96N/SC9	T31
1112	T279
1128BM	T279
1726	T279
1728BM	T279
1751N	T279
VP5	VP5
435/1,5	T273
435/3	T273
436/1	T273
436/2	T273
444/1	T273
444/2	T273
1707	T273
430	T270
433	T270
440	T270
440A	T270
441	T270
441A	T270



T80 T05 T06



T91 T68 T40 T41



T199 T202 T201 T204



T234 T281 T153 T236



T145 T137 T31



T279 VP5



T273 T270

€

5908VI/2T 3.610,00 059081105

Assortiment aanbevolen in combinatie met RSC28 - RSC24/8 - RSC24A/8 - RSC24AXL met 8-9 laden - C37/8 - C39/8 - C59B



5910VI/3

Assortiment van 297 gereedschappen

► Industrieel onderhoud

Aantal/Omschrijving	Beta Nr.
6 Ø 2 - 3 - 4 - 5 - 6 - 8 mm	31/B6N
1 centerpunt Ø 4 mm	32
2 koudbeitels, geprofileerd model 125 - 250 mm	35
1 ritsbeitel, geprofileerd model 200 mm	37
30 ringsteeksleutels 6-7-8-9-10-11-12-13-14-15-16	42
17-18-19-20-21-22-23-24-25-26-27-28-29-30-32-35-36-38-41 mm	
14 dubbele steeksleutels 6x7 - 8x9 - 10x11 - 12x13 - 14x15 - 16x17	55
18x19 - 20x22 - 21x23 - 24x26 - 25x28 - 27x29 - 30x32 - 36x41 mm	
13 ringsleutels, diepgebogen 6x7+30x32 mm	90
14 haakse stiftsleutels gebruneerd Ø 1,5 - 2 - 2,5 - 3 - 4 - 5 - 6 - 8 - 10	96N
- 12 - 13 - 14 - 17 - 19 mm	
1 Verstelbare moersleutel 250 mm	111E
1 Pijptang, zware uitvoering 300 mm	362
25 Geslepen boren, korte uitvoering 1+13x0,5 mm	412/SP25
37 Assortiment van HSS tappen en snijplaten, metrische draad	447/C37
1 ZERO-RESET momentsleutels met klikmechanisme	666/20
⊕ 1/2", 40±200 Nm	
1 1/2" T-sleutel met cardangewricht	920/40
4 1/2" schroevendraaiers voor inbusschroeven	920ME
⊙ 10-12-14-17 mm	
25 Doppendoos met 20 dopsleutels en 5 toebehoren	920A/C20X
17 12 - delige set met dopsleutels en 5 toebehoren 3/4"	928A/C12
12 gebogen pijpsleutels, tweekant en zeskant 8 - 10 - 11 - 13 - 14 - 17	932
- 19 - 22 - 24 - 27 - 30 - 32 mm	
14 inbus T-sleutels met zeskant profiel op drie zijden 2+14 mm	951/S14
5 inbus T - stiftsleutels met cardangewricht ⊙ 3 - 4 - 5 - 6 - 8 mm	953
3 borgveertangen, inwendig rechte punten ⊙ 180 - 225 - 300 mm	1032
3 borgveertangen, inwendig 90° gebogen punten ⊙ 170 - 210 - 290 mm	1034
3 borgveertangen, uitwendig rechte punten ● 140x1,3 - 175 - 225 mm	1036
3 borgveertangen, uitwendig 90° gebogen punten	1038
● 135x1,3 - 175 - 220 mm	
2 Waterpomp met Slip-proof PVC 250 - 300 mm	1048N
1 griptang dubbel verstelbaar	1051
1 Zijkniptangen, twee componenten handgreep, industriële afwerking	1084GBM
160 mm	
1 hefboom kopkniptang 180 mm	1092V
1 blikschaar 300 mm	1112
1 Blikschaar, rechte smalle bladen 250 mm	1114
1 elektricienschaar, rechte bladen	1128BMX
1 Zware combinatietangen, twee componenten handgreep, industriële afwerking	1150GBM
180 mm	
1 Telefoontangen, extra lange halfronde gegroefde bekken, twee componenten handgreep, industriële afwerking	1166GBM
● 160 mm	
1 Telefoontangen, lange halfronde gebogen bekken, twee componenten handgreep, industriële afwerking	1168GBM
● 160 mm	
9 Schroevendraaiers voor sleufschroeven ● 2,5x50 - 3x75 - 3,5x150 - 4x125 - 5,5x125 - 6,5x150 - 8x200 - 10x200 - 12x250 mm	1260
2 schroevendraaier voor sleufschroeven extra korte uitvoering ● 4x30 - 6,5x30 mm	1260N
5 Schroevendraaiers voor Phillips® kruiskop schroeven ⊕ PH0x100 - PH1x120 - PH2x150 - PH3x150 - PH4x200 mm	1262
2 schroevendraaiers voor Phillips® kruiskopschroeven extra korte uitvoering ⊕ PH1x30 - PH2x30 mm	1262N
7 schroevendraaiers voor Torx® schroeven	1267TX
⊙ T6 - T8 - T10 - T15 - T20 - T25 - T30	
2 bankhamer 300 - 600 g	1370
2 kunststof hamer Ø 35 - 60 mm	1390
5 Tapeinduithalers M3+M18	1430/S5
1 trekker, twee - armig 23±70 mm	1500N/1
1 trekker, twee - armig 23±100 mm	1500N/2
1 Schuifmaat	1650
1 halfstijve liniaal 300 mm	1683
1 kraspen	1688A
1 rolbandmaat 5 m	1692
1 voelmaat	1708/13
1 flexibele magneet 1,8 kg	1712E/2
5 halfzoete vijlen 200 mm	1719BMA8/S5
1 zaagbeugel	1726BM
1 blindklingtang	1741B
1 metalen oliekan met pomp, 200 cc	1751N

€ 

5910VI/3 7.450,00 059101044

Assortiment is aanbevolen voor gebruik met artikel C30M

5910VI/3T

Assortiment van 261 gereedschappen in voorgevormde ABS inlegbakken

► Industrieel onderhoud

Aantal/Omschrijving

Aantal/Omschrijving	Beta Nr.	TR
16 ringsteeksleutels 6÷21 mm	42	T05
5 ringsteeksleutels 22 - 24 - 27 - 30 - 32 mm	42	T06
5 pendrijvers Ø 2 - 3 - 4 - 5 - 6 mm	31	T31
1 centerpunt Ø 4 mm	32	T31
13 dubbele steeksleutels 6x7 - 8x9 - 10x11 - 12x13 - 14x15 - 16x17	55	T31
18x19 - 20x22 - 21x23 - 24x26 - 27x29 - 30x32 mm		
9 haakse inbus sleutels ⌀ 1,5 - 2 - 2,5 - 3 - 4 - 5 - 6 - 8 - 10 mm	96N/SC9	T31
9 ringsleutels, diepgebogen 20x22 - 21x23 - 24x26 - 25x28 - 27x29 mm	90	T48
7 ringsleutels, diepgebogen 6x7 - 8x9 - 10x11 - 12x13 - 14x15 - 16x17	90	T40
18x19 mm		
5 1/2" schroevendraaiers voor inbus schroeven ⌀ 5 - 6 - 8 - 10 - 12 mm	920ME	T80
1 1/2" verlengstuk 125 mm	920/21	T80
1 1/2" verlengstuk 255 mm	920/22	T80
1 1/2" cardangewricht	920/25	T80
1 1/2" wringstaaf	920/42	T80
1 1/2" omschakelbare ratel Ⓢ	920/55	T80
19 1/2" dopsleutels, zeskant ⌀ 10÷24 - 26 - 27 - 30 - 32 mm	920A	T80
9 Schroevendraaiers voor sleufschroeven ● 3x75 - 3x100 - 4x100 - 4x150 - 5,5x100 - 5,5x150	1260	T167
- 6,5x150 - 8x150 - 10x200 mm		
2 schroevendraaiers voor sleufschroeven extra korte uitvoering ● 4x30 - 6,5x30 mm	1260N	T167
7 Schroevendraaiers voor Phillips® kruiskop schroeven ● PH0x60 - PH0x100 - PH1x80 - PH1x120 - PH2x100 - PH2x150 - PH3x150 mm	1262	T168
2 schroevendraaiers voor Phillips® kruiskopschroeven extra korte uitvoering	1262N	T168
● PH1x30 - PH2x30 mm		
4 haakse stiftsleutels gebruneerd ⌀ 13-14-17-19 mm	96N	T168
1 blikchaar 250 mm	1112	T279
1 elektricien schaar rechte bladen	1128BM	T279
1 zaagbeugel	1726	T279
(5) zaagbladen voor zaagbeugels	1728BM	T279
1 metalen oliekan met pomp, 200 cc	1751N	T279
1 combinatietang hoogverchroomd ≡ 180 mm	1150BM	T137
1 Telefoon tang, lange halfronde gegroefde bekken ● 160 mm	1166BM	T137
1 Zijknijptangen, zware uitvoering ≡ 160 mm	1084BM	T137
1 borgveertangen, inwendig rechte punten ⌀ 180 mm	1032	T145
1 borgveertangen, inwendig 90° gebogen punten ⌀ 170 mm	1034	T145
1 borgveertangen, uitwendig rechte punten ● 175mm	1036	T145
1 borgveertangen, uitwendig 90° gebogen punten ● 175mm	1038	T145
2 koudbeitels, geprofileerd model 100 - 200 mm	35	T234
1 bankhamer 300 g	1370	T234
1 kunststof hamer Ø 35 mm	1390	T234
1 halfzoete vijlen 200 mm	1719BMA8/S5	T236
4 ringsteeksleutels 35-36-38-41 mm	42	
1 dubbele steeksleutels 36x41 mm	55	
1 Verstelbare moersleutel 250 mm	111E	
1 Pijpentang, zware uitvoering 300 mm	362	
25 Geslepen boren, korte uitvoering	412/SP25	
37 Assortiment van HSS tappen en snijplaten, metrische draad	447/C37	
1 ZERO-RESET momentsleutels met klikmechanisme Ⓢ 40÷200 Nm	666/20	
17 12 - delige set met dopsleutels en 5 toebehoren 3/4"	928AC12	
14 inbus T-sleutels met zeskant profiel op drie zijden	951/S14	
5 inbus T - stiftsleutels met cardangewricht ⌀ 3-4-5-6-8 mm	953	
1 borgveertangen, inwendig rechte punten ⌀ 300 mm	1032	
1 borgveertangen, inwendig 90° gebogen punten ⌀ 290 mm	1034	
1 borgveertangen, uitwendig rechte punten ● 225 mm	1036	
1 borgveertangen, uitwendig 90° gebogen punten ● 220 mm	1038	
1 Waterpomptang met Slip-proof PVC 300 mm	1048N	
1 griptang dubbel verstelbaar	1051	
1 hefboom kopknijptang ≡ 180 mm	1092V	
1 bankhamer 600 g	1370	
1 kunststof hamer 60 mm	1390	
5 Tapeinduithalers M3-M18	1430/S5	
1 trekker, twee - armig	1500/3	
1 Schuifmaat	1650	
1 halfstijve liniaal	1683	
1 kraspen	1688	
1 rolbandmaat 5 m	1692	
1 voelmaat	1708/13	
1 flexibele magneet	1712E/2	

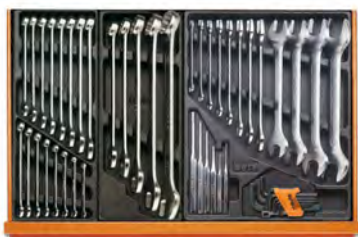

T05 T06 T31



T40 T41 T80



T167 T168 +96N



T279
T137 T145 T234 T236



€

5910VI/3T

6.370,00 059101063

Assortiment is aanbevolen voor gebruik met artikel C30M

5935VI/2MB

Assortiment van 133 gereedschappen voor ladenblok C35, in voorgevormde EVA foam inlegbakken

► Industrieel onderhoud

Aantal/Omschrijving

- 21 ringsteeksleutels 6-7-8-9-10-11-12-13-14-15-16-17-18-19-20-21-22-24-27-30-32 mm
- 8 dubbele steeksleutels 6x7-8x9-10x11-12x13-14x15
16x17-18x19-20x22 mm
- 1 Waterpomptang met Slip-proof PVC 250 mm
- 19 1/2" dopsleutels, zeskant ○ 10-11-12-13-14-15-16-17-18-19-20-21-22-23-24-26-27-30-32 mm
- 1 1/2" verlengstuk met kogelkop 125 mm
- 1 1/2" verlengstuk met kogelkop 150 mm
- 1 1/2" cardangewricht
- 1 1/2" wringstaaf
- 1 1/2" omschakelbare ratel ⊗
- 1 Verstelbare moersleutel 250 mm
- 1 Verstelbare griptang 240 mm
- 1 Zijkniptangen, zware uitvoering ⚡ 160 mm
- 1 combinatietang hoogverchromd ≡ 180 mm
- 1 Telefoon tang, lange halfronde gegroefde bekken ● 160 mm
- 1 borgveertangen, inwendig rechte punten ○ 180 mm
- 1 borgveertangen, inwendig 90° gebogen punten ○ 170 mm
- 1 borgveertangen, uitwendig rechte punten ● 175 mm
- 1 borgveertangen, uitwendig 90° gebogen punten ● 175 mm
- 13 1/4" dopsleutels, zeskant ○ 4-4,5-5-5,5-6-7-8-9-10-11-12-13-14 mm
- 1 1/4" verlengstuk 50 mm
- 1 1/4" verlengstuk 150 mm
- 1 1/4" cardangewricht
- 1 1/4" steekhecht
- 1 1/4" omschakelbare ratel ⊗
- 1 1/4" wringstaaf met schuifstuk
- 7 Schroevendraaiers voor sleufschroeven
● 2,5x50-3x75-3,5x100-4x100-5,5x125-6,5x150-8x200 mm
- 2 schroevendraaier voor sleufschroeven extra korte uitvoering ● 4x30-6,5x30 mm
- 7 Schroevendraaiers voor Phillips® kruiskop schroeven ⊕ PH0x60-PH0x100-PH1x80-PH1x120-PH2x100-PH2x150-PH3x150 mm
- 2 schroevendraaiers voor Phillips® kruiskopschroeven extra korte uitvoering
⊕ PH1x30-PH2x30 mm
- 1 spanningszoeker ● 4x30-6,5x30 mm
- 9 Haakse stijsleutels met kogelkop ○
- 6 inbus T-sleutels met zeskant profiel op drie zijden 2,5-3-4-5-6-8 mm
- 5 pendrijvers Ø 2-3-4-5-6 mm
- 1 centerpunt Ø 4 mm
- 1 koudbeitels, geprofileerd model 200 mm
- 1 blikschaar 250 mm
- 1 elektricienschaar, rechte bladen
- 1 bankhamer 500 g
- 1 kunststof hamer Ø 45 mm
- 1 Halfzoeten vijlen, vierkant met handgreep 200 mm
- 1 Halfzoeten vijlen, driehoek met handgreep 200 mm
- 1 Halfzoeten vijlen, plat met handgreep 200 mm
- 1 Halfzoeten vijlen, halfrond met handgreep 200 mm
- 1 Halfzoeten vijlen, rond met handgreep 200 mm
- 1 zaagbeugel 440 mm

Beta Nr.	TR
42	MB12
55	MB12
1048N	MB12
920A	MB37
920AN/125	MB37
920AN/250	MB37
920/25	MB37
920/42	MB37
920/55	MB37
111E	MB37
1052	MB37
1084BM	MB37
1150BM	MB37
1166BM	MB37
1032	MB37
1034	MB37
1036	MB37
1038	MB37
900	MB37
900/20	MB37
900/21	MB37
900/25	MB37
900BG/30	MB37
900/55	MB37
900/42	MB37
1260	MB44
1260N	MB44
1262	MB44
1262N	MB44
1253	MB44
96BPC/SC9	MB44
951	MB44
31	MB55
32	MB55
35	MB55
1112	MB55
1128BMX	MB55
1370	MB55
1390	MB55
1719BMA...Q	MB55
1719BMA...T	MB55
1719BMA...P	MB55
1719BMA...M	MB55
1719BMA...R	MB55
1726	MB55



MB12



MB37

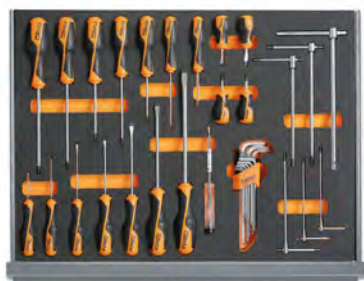

MB44



MB55

€

5935VI/2MB 2.435,00 059351316

Assortiment aanbevolen in combinatie met C35

5957VI

Assortiment van 162 gereedschappen

► Industrieel onderhoud



Aantal/Omschrijving	Beta Nr.
6 pendrijvers Ø 2 - 3 - 4 - 5 - 6 - 8 mm	31/SP6
6 beitels in houder	38/SP6
18 ringsteeksleutels 6-7-8-10-11-12-13-14-15-16-17-19-21-22-24-27-30-32 mm	42
12 dubbele steeksleutels 6x7 + 30x32 mm	55/S12X
8 haakse stiftsleutels met kracht handgreep 2 - 2,5 - 3 - 4 - 5 - 6 - 8 - 10 mm	96T/S8
8 haakse stiftsleutels voor Torx® schroeven ⚙ T9 - T10 - T15 - T20 - T25 - T27 - T30 - T40	97TX/SC8
1 Verstelbare moersleutel 250 mm	111E
13 1/2" twaalfkant doppen op dophouder Ø 10+22 mm	920B/SB13
8 1/2" twaalfkant doppen op dophouder Ø 23+32 mm	920B/SB8
4 schroevendraaierdoppen voor sleufschroeven ● 1,2x6,5 - 1,2x8 - 1,6x9 - 2x12 mm	920LP
3 schroevendraaierdoppen voor Phillips® kruiskopschroeven ⚙ PH2 - 3 - 4	920PH
1 1/2" verlengstuk 125 mm	920/21
1 1/2" verlengstuk 255 mm	920/22
1 1/2" cardangewricht	920/25
1 1/2" wringstaaf	920/42
1 1/2" omschakelbare ratel ⚙	920/55
1 puntschop	963
2 borgveertangen, inwendig rechte punten ⚙ 140 - 180 mm	1032
2 borgveertangen, inwendig 90° gebogen punten ⚙ 130 - 170 mm	1034
2 borgveertangen, uitwendig rechte punten ● 140 - 175 mm	1036
2 borgveertangen, uitwendig 90° gebogen punten ● 135 - 175 mm	1038
1 Waterpomptang met Slip-proof PVC 250 mm	1048N
1 griptang dubbel verstelbaar	1051
1 Zijknijptangen, zware uitvoering ⚡ 160 mm	1084BM
1 hefboom kopknijptang ⚡ 180 mm	1092V
1 blikshaar 250 mm	1112
1 Blikshaar, rechte smalle bladen 250 mm	1114
1 elektricienschaar, rechte bladen	1128BMX
1 combinatietang hoogverchroomd ≡ 180 mm	1150BM
1 Telefoontang, lange halfronde gegroefde bekken ● 160 mm	1166BM
1 Telefoontang, lange halfronde gebogen bekken ● 160 mm	1168BM
7 Schroevendraaiers voor sleufschroeven ● 2,5x50 - 3x75 - 4x100 5,5x125 - 6,5x150 - 8x200 - 10x200 mm	1260
4 Schroevendraaiers voor Phillips® kruiskop schroeven ⚙ PH0x60 - PH1x80 - PH2x100 - PH3x150 mm	1262
3 bankhamer 300 - 600 - 1000 g	1370
1 kunststof hamer Ø 35 mm	1390
1 rolbandmaat 5 m	1692
1 flexibele magneet 1,8 kg	1712E/2
1 schraapstaal, half rond model 200 mm	1717A
1 schraapstaal, driekantig model 200 mm	1717B
5 halfzoete vijlen 200 mm	1719BMA8/S5
1 zaagbeugel	1725
1 metalen oliekan met pomp 200 cc	1751
1 koudbeitels, geprofileerd model 200 mm	35
1 ritsbeitel, geprofileerd model 200 mm	37
11 gebogen pijpsleutels, twaalfkant en zeskant 8 - 10 - 11 - 12 - 13 - 14 - 16 - 17 - 19 - 22 - 24 mm	932
1 Verstelbare griptang 240 mm	1052
1 Verstelbare griptang 280 mm	1060
1 Verstelbare griptang 290 mm	1062
1 terugslagvrije hamer Ø 50 mm	1392
1 trekker, twee - armig 25+130 mm	1500N/2
1 Schuifmaat	1650
1 halfstijve liniaal 300 mm	1683
1 kraspen	1688A
1 voelermaat	1708/13
1 klapmesmet inkeping	1777BM
1 afbreekmes, plat model 170 mm	1771BM
1 Zijknijptangen ⚡ 160 mm	1082BM

€ 

5957VI 3.820,00 059571005

Assortiment aanbevolen in combinatie met C57SA - C57SB - C57SP

5954VI

133-delig assortiment gereedschappen

► Industrieel onderhoud

Aantal/Omschrijving	Beta Nr.
5 pendrijvers Ø 2-3-4-5-6 mm	31
1 centerpunt Ø 4 mm	32
2 koudbeitels, geprofileerd model 200-250 mm	35
18 ringsteeksleutels 6x14 - 16 - 17 - 18 - 19 - 21 - 22 - 24 - 27 - 30 mm	42
12 dubbele steeksleutels 6x7 - 8x9 - 10x11 - 12x13 - 14x15 - 16x17 18x19 - 20x22 - 21x23 - 24x26 - 27x29 - 30x32 mm	55
12 haakse inbussleutels Ø 2+10 mm	96/SC12
1 Verstelbare moersleutel 250 mm	111E
1 pijpentang 320 mm	374
20 1/2" dopsleutels, zeskant Ø 10+24 - 26 - 27 - 28 - 30 - 32 mm	920A
6 1/2" schroevendraaiers voor inbusschroeven Ø 5 - 6 - 8 - 10 - 12 - 14 mm	920ME
1 1/2" verlengstuk 125 mm	920/21
1 1/2" verlengstuk 255 mm	920/22
1 1/2" cardangewricht	920/25
1 1/2" T-sleutel met cardangewricht	920/40
1 1/2" wringstaaf	920/42
1 1/2" omschakelbare ratel Ⓢ	920/55
6 inbus T-sleutels met zeskant profiel op drie zijden 2,5 - 3 - 4 - 5 - 6 - 8 mm	951
2 borgveertangen, inwendig rechte punten Ø 140 - 180 mm	1032
1 borgveertangen, inwendig 90° gebogen punten Ø 170 mm	1034
2 borgveertangen, uitwendig rechte punten ● 140x1,3 - 175 mm	1036
1 borgveertangen, uitwendig 90° gebogen punten ● 175 mm	1038
1 Waterpomptang met Slip-proof PVC 250 mm	1048N
1 Verstelbare griptang 240 mm	1052
1 Zijkniptangen, zware uitvoering ≤ 160 mm	1084BM
1 hefboom kopkniptang ≤ 180 mm	1092V
1 blikschaar 250 mm	1112
1 elektricienschaar, rechte bladen	1128BMX
1 combinatietang hoogverchroomd = 180 mm	1150BM
1 Telefoontang, lange halfronde gegroefde bekken ● 160 mm	1166BM
1 spanningszoeker ●	1253
2 Schroevendraaiers voor sleufschroeven ● 8x150 - 10x200 mm	1260
2 schroevendraaier voor sleufschroeven extra korte uitvoering ● 4x30 - 6,5x30 mm	1260N
2 Schroevendraaiers voor Phillips® kruiskop schroeven ● PH3x150 - PH4x200 mm	1262
2 schroevendraaiers voor Phillips® kruiskopschroeven extra korte uitvoering ● PH1x30 - PH2x30 mm	1262N
8 schroevendraaiers	1263/D8
2 bankhamer 300 - 500 g	1370
1 kunststof hamer Ø 45 mm	1390
1 rolbandmaat 5 m	1692
1 flexibele magneet 0,5 kg	1712E/1
5 halfzoete vijlen 200 mm	1719BMA8/S5
1 zaagbeugel	1726BM
1 kunststof oliekan met pomp 250 cc	1754



€



5954VI

2.580,00 059541053

Assortiment aanbevolen in combinatie met C54S-C55C



M05 M33 M204 M201



M50 M83



M137 M153 M234 M145

5904VU/1M

Assortiment van 90 gereedschappen in voorgevormde EVA foam inlegbakken

► Universeel gebruik

Aantal/Omschrijving

- 16 ringsteeksleutels 6÷21 mm
- 8 dubbele steeksleutels 6x7 - 8x9 - 10x11 - 12x13 - 14x15 - 16x17 - 18x19 - 20x22 mm
- 9 haakse inbussleutels \odot 1,5 - 2 - 2,5 - 3 - 4 - 5 - 6 - 8 - 10 mm
- 6 schroevendraaiers voor Torx® schroeven \odot T8-T10-T15-T20-T25-T30
- 3 Schroevendraaiers voor sleufschroeven \bullet 3x75-4x100-6,5x150 mm
- 3 Schroevendraaiers voor Phillips® kruiskop schroeven \oplus PH0x60-PH1x80-PH2x100 mm
- 8 haakse stiftsleutels met kracht handgreep \odot 2-2,5-3-4-5-6-7-8 mm
- 1 1/2" verlengstuk met kogelkop 125 mm
- 1 1/2" verlengstuk met kogelkop 250 mm
- 1 1/2" cardangewricht
- 1 1/2" wringstaaf
- 1 1/2" omschakelbare ratel \oplus
- 19 1/2" dopsleutels, zeskant \odot 10÷24 - 26 - 27 - 30 - 32 mm
- 1 Zijknijptangen, zware uitvoering \llcorner 160 mm
- 1 Combinatietangen \equiv 180 mm
- 1 Telefoontang, lange platte gegroefde bekken \bullet 160 mm
- 1 Waterpomptang met Slip-proof PVC 250 mm
- 1 Verstelbare griptang 240 mm
- 2 koudbeitels, geprofileerd model 100 - 200 mm
- 1 bankhamer 300 g
- 1 kunststof hamer \varnothing 35 mm
- 1 borgveertangen, inwendig rechte punten \odot 180 mm
- 1 borgveertangen, inwendig 90° gebogen punten \odot 170 mm
- 1 borgveertangen, uitwendig rechte punten \bullet 175 mm
- 1 borgveertangen, uitwendig 90° gebogen punten \bullet 175 mm

Beta Nr.	TR
42	M05
55	M33
96/SC9	M33
1267TX	M204
1260	M201
1262	M201
96T	M50
920AN/125	M83
920AN/250	M83
920/25	M83
920/42	M83
920/55	M83
920A	M83
1084	M137
1150	M137
1166	M137
1048N	M153
1052	M153
35	M234
1370	M234
1390	M234
1032	M145
1034	M145
1036	M145
1038	M145

€



5904VU/1M

1.470,00 059041201

Assortiment aanbevolen in combinatie met RSC51 - RSC23T - RSC24 - RSC24A - RSC24AXL - RSC24L/7 - RSC24L-CAB - RSC28 C37 - C39 - C39T - C39SM - C39MD - RSC50 - RSC55 - C59

5904VU/2M

Assortiment van 144 gereedschappen in voorgevormde EVA foam inlegbakken

► Universeel gebruik

Aantal/Omschrijving

- 16 ringsteeksleutels 6÷21 mm
- 8 dubbele steeksleutels 6x7 - 8x9 - 10x11 - 12x13 - 14x15 - 16x17 - 18x19 - 20x22 mm
- 9 haakse inbussleutels \odot 1,5 - 2 - 2,5 - 3 - 4 - 5 - 6 - 8 - 10 mm
- 3 Schroevendraaiers voor sleufschroeven \bullet 3x75-4x100-6,5x150 mm
- 3 Schroevendraaiers voor Phillips® kruiskop schroeven \oplus PH0x60-PH1x80-PH2x100 mm
- 6 schroevendraaiers voor Torx® schroeven \odot T8-T10-T15-T20-T25-T30
- 8 haakse stiftsleutels met kracht handgreep \odot 2-2,5-3-4-5-6-7-8 mm
- 1 1/2" verlengstuk met kogelkop 125 mm
- 1 1/2" verlengstuk met kogelkop 250 mm
- 1 1/2" cardangewricht
- 1 1/2" wringstaaf
- 1 1/2" omschakelbare ratel \oplus
- 19 1/2" dopsleutels, zeskant \odot 10÷24 - 26 - 27 - 30 - 32 mm
- 1 Zijknietangen, zware uitvoering \llcorner 160 mm
- 1 Combinatietangen \equiv 180 mm
- 1 Telefoontang, lange platte gegroefde bekken \bullet 160 mm
- 1 Waterpomptang met Slip-proof PVC 250 mm
- 1 Verstelbare griptang 240 mm
- 2 koudbeitels, geprofileerd model 100 - 200 mm
- 1 Bankhamer, kunststof steel 300 g
- 1 Nylon hamers, houten steel \varnothing 35 mm
- 1 borgveertangen, inwendig rechte punten \odot 180 mm
- 1 borgveertangen, inwendig 90° gebogen punten \odot 170 mm
- 1 borgveertangen, uitwendig rechte punten \bullet 175 mm
- 1 borgveertangen, uitwendig 90° gebogen punten \bullet 175 mm
- 1 zachte voorgevormde inlegbak
- 1 rolbandmaat 5 m
- 1 mini zaagbeugel
- 1 Reserve afbreekmessen 18 mm, verpakt per 10 stuks, voor model 1771, 1771BM, 1771HD
- 1 afbreekmes, plat model
- 5 Bit voor sleufschroeven, met kleur indicatie \bullet 0,5x3 - 0,6x4,5 - 0,8x5,5 - 1x5,5 - 1,2x6,5 mm
- 8 Bits voor binnenzeskant schroeven, met kleur indicatie \odot 2 - 2,5 - 3 - 4 - 5 - 6 - 8 - 10 mm
- 5 Bits voor kruiskopschroeven met Phillips® profiel, met kleur indicatie \oplus PH0 - PH1 - PH2 - PH3 - PH4
- 4 Bits voor kruiskopschroeven met Pozidriv® - Supadriv® profiel, met kleur indicatie \oplus PZ1 - PZ2 - PZ3 - PZ4
- 11 Bits voor schroeven met Torx® profiel, met kleur indicatie \odot T6-T7-T8-T9-T10-T15-T20-T25-T27-T30-T40
- 8 Bits voor schroeven met Tamper Resistant Torx® profiel, met kleur indicatie \oplus T9-T10-T15-T20-T25-T27-T30-T40
- 1 Magnetische bithouder met handgreep 230 mm
- 1 Omschakelbare ratel voor bits 100 mm
- 5 halfzoete vijlen 200 mm
- 1 Dophouders
- 1 Magnetische bithouder, lang

Beta Nr.	TR
	42
	55
96/SC9	M33
	1260
	1262
1267TX	M201
96T	M204
920AN/125	M50
920AN/250	M83
920/25	M83
920/42	M83
920/55	M83
920A	M83
1084	M137
1150	M137
1166	M137
1048N	M153
1052	M153
35	M237
1370T	M237
1390N	M237
1032	M145
1034	M145
1036	M145
1038	M145
VPM3	VPM3
1692	M294
1725CR	M294
1771RL	M294
1771	M294
860LP	M85
860PE	M85
860PH	M85
860PZ	M85
860TX	M85
860RTX	M85
851SR	M85
860/55	M85
1719BMA8/S5	M236
892/0	M85
882P	M85



M05 M33 M204 M201



M50 M83



M137 M153 M237 M145



VPM3 M294 M85 M236

€

5904VU/2M 1.940,00 059041212

Assortiment aanbevolen in combinatie met RSC23T - RSC24 - RSC24A - RSC24AXL - RSC24L/7 - RSC24L-CAB
RSC28 - C37 - C39 - C39SM - C39MD - C39T - RSC50 - RSC55 - C59

5904VU/2T

Assortiment van 104 gereedschappen in voorgevormde ABS inlegbakken

► Universeel gebruik

Aantal/Omschrijving

- 7 Schroevendraaiers voor sleufschroeven ● 2,5x50 - 3x75 - 3,5x100 - 4x125
5,5x100 - 5,5x150 - 6,5x150 mm
- 6 Schroevendraaiers voor Phillips® kruiskop schroeven ● PH0x60 - PH0x100 - PH1x80 - PH1x120 - PH2x100 - PH2x150 mm
- 19 1/2" dopsleutels, zeskant ○ 10-11-12-13-14-15-16-17-18-19
20-21-22-23-24-26-27-30-32 mm
- 1 1/2" verlengstuk 125 mm
- 1 1/2" verlengstuk 255 mm
- 1 1/2" cardangewricht
- 1 1/2" wringstaaf 305 mm
- 1 1/2" omschakelbare ratel ⚙
- 1 borgveertangen, inwendig rechte punten ○ 180 mm
- 1 borgveertangen, inwendig 90° gebogen punten ○ 170 mm
- 1 borgveertangen, uitwendig rechte punten ● 175 mm
- 1 borgveertangen, uitwendig 90° gebogen punten ● 175 mm
- 1 Waterpomptang met Slip-proof PVC 250 mm
- 1 Verstelbare griptang 240 mm
- 1 Zijkniptangen, zware uitvoering ⚡ 160 mm
- 1 Combinatietangen = 180 mm
- 1 Telefoontang, lange platte gegroefde bekken ● 160 mm
- 2 koudbeitels, geprofileerd model 100-200 mm
- 1 bankhamer 300 g
- 1 kunststof hamer Ø 35 mm
- 6 inbus T-sleutels met zeskant profiel op drie zijden 2,5-3-4-5-6-8 mm
- 8 dubbele steeksleutels 6x7-8x9-10x11-12x13-14x15
16x17-18x19-20x22 mm
- 9 haakse inbussleutels ○ 1,5÷10 mm
- 16 ringsteeksleutels 6-7-8-9-10-11-12-13-14-15-16-17
18-19-20-21 mm
- 5 ringsteeksleutels 22-24-27-30-32 mm
- 1 elektricienschaar, rechte bladen
- 1 Universele schaar
- 1 Halfzoeten vijlen, vierkant met handgreep 200 mm
- 1 Halfzoeten vijlen, plat met handgreep 200 mm
- 1 Halfzoeten vijlen, driehoek met handgreep 200 mm
- 1 Halfzoeten vijlen, halfrond met handgreep 200 mm
- 1 Halfzoeten vijlen, rond met handgreep 200 mm
- 1 zaagbeugel
- 1 zaagbladen voor zaagbeugels
- 1 afbreekmes, plat model 170 mm
- 1 185 mm

Beta Nr.	TR
1260	T199
1262	T202
920A	T83
920/21	T83
920/22	T83
920/25	T83
920/42	T83
920/55	T83
1032	T145
1034	T145
1036	T145
1038	T145
1048N	T153
1052	T153
1084	T138
1150	T138
1166	T138
35	T234
1370	T234
1390	T234
951	T68
55	T33
96/SC9	T33
42	T05
42	T06
1128BMX	T284
1130BMX	T284
1719BMA...Q	T284
1719BMA...P	T284
1719BMA...T	T284
1719BMA...M	T284
1719BMA...R	T284
1726BM	T284
1728BM	T284
1771BM	T284
1778V18	T284



T199 T202 T83



T145 T153 T138 T234



T68 T33 T05 T06



T284

€

5904VU/2T 1.770,00 059041070

Assortiment aanbevolen in combinatie met RSC23T - RSC24 - RSC24A - RSC24AXL - RSC24L/7 - RSC24L-CAB - RSC28 - C37 - C39 - C39SM - C39MD - C39T - RSC50 - RSC55 - C59

5904VU/3T

Assortiment van 146 gereedschappen in voorgevormde ABS inlegbakken

► Universeel gebruik

Aantal/Omschrijving

- 16 ringsteeksleutels 6÷21 mm
- 5 ringsteeksleutels 22 - 24 - 27 - 30 - 32 mm
- 5 pendrijvers Ø 2 - 3 - 4 - 5 - 6 mm
- 1 centerpunt Ø 4 mm
- 12 dubbele steeksleutels 6x7 - 8x9 - 10x11 - 12x13 - 14x15 - 16x17 - 18x19 - 20x22 - 21x23 - 24x26 - 27x29 - 30x32 mm
- 9 haakse inbussleutels ⌀ 1,5 - 2 - 2,5 - 3 - 4 - 5 - 6 - 8 - 10 mm
- 6 haakse stiftsleutels met kracht handgreep ⌀ 2 - 2,5 - 3 - 4 - 5 - 6 mm
- 6 schroevendraaiers voor Torx® schroeven ⚙ T10-T15-T20-T25-T27-T30
- 5 1/2" schroevendraaierdoppen voor inbusschroeven ⌀ 5 - 6 - 8 - 10 - 12 mm
- 1 1/2" verlengstuk 125 mm
- 1 1/2" verlengstuk 255 mm
- 1 1/2" cardangewricht
- 1 1/2" wringstaaf
- 1 1/2" omschakelbare ratel ⚙
- 19 1/2" dopsleutels, zeskant ⌀ 10÷24 - 26 - 27 - 30 - 32 mm
- 13 1/4" dopsleutels, zeskant ⌀ 4-4,5-5-5,5-6-7-8-9-10-11-12-13-14 mm
- 6 1/4" schroevendraaierdoppen voor inbusschroeven ⌀ 2,5-3-4-5-6-8 mm
- 1 1/4" verlengstuk 50 mm
- 1 1/4" verlengstuk 150 mm
- 1 1/4" cardangewricht
- 1 1/4" steekhecht
- 1 1/4" wringstaaf met schuifstuk 115 mm
- 1 1/4" omschakelbare ratel ⚙
- 1 borgveertangen, inwendig rechte punten ⌀ 180 mm
- 1 borgveertangen, inwendig 90° gebogen punten ⌀ 170 mm
- 1 borgveertangen, uitwendig rechte punten ● 175 mm
- 1 borgveertangen, uitwendig 90° gebogen punten ● 175 mm
- 1 Combinatietangen = 180 mm
- 1 Telefoon tang, lange platte gegroefde bekken ● 160 mm
- 1 Zijkniptangen, zware uitvoering ⚡ 160 mm
- 1 Waterpomptang met Slip-proof PVC 250 mm
- 1 Verstelbare griptang 240 mm
- 4 Schroevendraaiers voor sleufschroeven ● 3x75 - 4x100 - 5,5x150 - 6,5x150 mm
- 3 Schroevendraaiers voor Pozidriv®-Supadriv® kruiskopschroeven ⚙ PZ0 - PZ1 - PZ2
- 7 schroevendraaiers voor Torx® schroeven ⚙ T6-T7-T8-T9-T10-T15-T20
- 2 koudbeitels, geprofileerd model 100 - 200 mm
- 1 bankhamer 300 g
- 1 kunststof hamer Ø 35 mm
- 5 halfzoete vijlen 200 mm

Beta Nr.	TR
	42
	42
	31
	32
	55
96N/SC9	T31
96T	T52
97TTX	T55
920ME	T80
920/21	T80
920/22	T80
920/25	T80
920/42	T80
920/55	T80
920A	T80
900	T91
900ME	T91
900/20	T91
900/21	T91
900/25	T91
900/25	T91
900BG/30	T91
900/42	T91
900/55	T91
1032	T145
1034	T145
1036	T145
1038	T145
1150	T138
1166	T138
1084	T138
1048N	T153
1052	T153
1260	T198
1269PZ	T198
1267TX	T205
35	T234
1370	T234
1390	T234
1719BMA&S5	T236



T05 T06 T31



T52 T55 T80



T91 T145 T138 T153



T198 T205 T234 T236

€

5904VU/3T 2.125,00 059041203

Assortiment aanbevolen in combinatie met RSC24 - RSC24A - RSC24AXL - RSC24L/7 - RSC24L-CAB - C37 - C39 - C39T - C39SM - C39MD - RSC50 - RSC55 - C59

5908VU/2T

161 delig assortiment in ABS voorgedrupte inlegbakken

► Universeel gebruik

Aantal/Omschrijving

- 16 ringsteeksleutels 6÷21 mm
- 5 ringsteeksleutels 22 - 24 - 27 - 30 - 32 mm
- 5 pendrijvers Ø 2 - 3 - 4 - 5 - 6 mm
- 1 centerpunt Ø 4 mm
- 12 dubbele steeksleutels 6x7 - 8x9 - 10x11 - 12x13 - 14x15 - 16x17 - 18x19 - 20x22 - 21x23 - 24x26 - 27x29 - 30x32 mm
- 9 haakse inbussleutels ⌀ 1,5 - 2 - 2,5 - 3 - 4 - 5 - 6 - 8 - 10 mm
- 7 ringsleutels, diepgebogen 6x7-8x9-10x11-12x13-14x15-16x17-18x19 mm
- 6 haakse stiftsleutels met kracht handgreep ⌀ 2-2,5-3-4-5-6 mm
- 6 schroevendraaiers voor Torx® schroeven ⚡ T10-T15-T20-T25-T27-T30
- 19 1/2" dopsleutels, zeskant ⌀ 10-11-12-13-14-15-16-17-18-19-20-21-22-23-24-26-27-30-32 mm
- 5 1/2" schroevendraaierdoppen voor inbusschroeven ⌀ 5-6-8-10-12 mm
- 1 1/2" verlengstuk met kogelkop 125 mm
- 1 1/2" verlengstuk met kogelkop 250 mm
- 1 1/2" cardangewricht
- 1 1/2" wringstaaf 305 mm
- 1 1/2" omschakelbare ratel ⚙
- 13 1/4" dopsleutels, zeskant ⌀ 4-4,5-5-5,5-6-7-8-9-10-11-12-13-14 mm
- 6 1/4" schroevendraaierdoppen voor inbusschroeven ⌀ 2,5-3-4-5-6-8 mm
- 1 1/4" verlengstuk 50 mm
- 1 1/4" verlengstuk 150 mm
- 1 1/4" cardangewricht
- 1 1/4" steekhecht
- 1 1/4" wringstaaf met schuifstuk 115 mm
- 1 1/4" omschakelbare ratel ⚙
- 1 Zijkniptangen, zware uitvoering ⚡ 160 mm
- 1 Combinatietangen ⚡ 180 mm
- 1 Telefoon tang, lange platte gegroefde bekken ● 160 mm
- 1 borgveertangen, inwendig rechte punten ⌀ 180 mm
- 1 borgveertangen, inwendig 90° gebogen punten ⌀ 170 mm
- 1 borgveertangen, uitwendig rechte punten ● 175 mm
- 1 borgveertangen, uitwendig 90° gebogen punten ● 175 mm
- 1 Waterpomptang met Slip-proof PVC 250 mm
- 1 Verstelbare griptang 240 mm
- 7 schroevendraaiers voor Phillips® kruiskopschroeven ● 2,5x50-3x75-3,5x100-4x125-5,5x100-5,5x150-6,5x150 mm
- 3 schroevendraaiers voor Phillips® kruiskopschroeven ● 8x150-8x200-10x200 mm
- 2 schroevendraaiers voor sleufschroeven extra korte uitvoering ● 4x30-6,5x30 mm
- 6 schroevendraaiers voor Phillips® kruiskopschroeven ⚡ PH0x60-PH0x100-PH1x80-PH1x120-PH2x100-PH2x150 mm
- 2 schroevendraaiers voor Phillips® kruiskopschroeven ⚡ PH3x150-PH4x200 mm
- 2 schroevendraaiers voor Phillips® kruiskopschroeven extra korte uitvoering ⚡ PH1x30-PH2x30 mm
- 2 koudbeitels, geprofileerd model 100-200 mm
- 1 bankhamer 300 g
- 1 kunststof hamer Ø 35 mm
- 1 Halfzoeten vijlen, vierkant met handgreep 200 mm
- 1 Halfzoeten vijlen, driehoek met handgreep 200 mm
- 1 Halfzoeten vijlen, plat met handgreep 200 mm
- 1 Halfzoeten vijlen, halfrond met handgreep 200 mm
- 1 Halfzoeten vijlen, rond met handgreep 200 mm
- 1

Beta Nr.	TR
42	T05
42	T06
31	T31
32	T31
55	T31
96N/SC9	T31
90	T40
96T	T52
97TTX	T55
920A	T82
920ME	T82
920AN/125	T82
920AN/250	T82
920/25	T82
920/42	T82
920/55	T82
900	T91
900ME	T91
900/20	T91
900/21	T91
900/25	T91
900BG/30	T91
900/42	T91
900/55	T91
1084	T138
1150	T138
1166	T138
1032	T145
1034	T145
1036	T145
1038	T145
1048N	T153
1052	T153
1290	T170
1290	T171
1290N	T171
1292	T172
1292	T173
1292N	T173
35	T234
1370	T234
1390	T234
1719BMA...Q	T236
1719BMA...T	T236
1719BMA...P	T236
1719BMA...M	T236
1719BMA...R	T236
VP4	

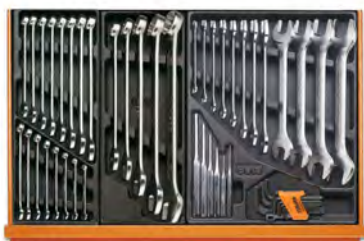

T05 T06 T31



T40 T52 T55 T91



T82 T138 T153



T145 T170 T171 T172



T173 T234 T236 VP4

€

5908VU/2T 2.435,00 059081136

Het assortiment is geschikt voor het opbergen in de artikelen RSC23T - RSC24 6-7-8 laden - RSC24A - RSC24AXL - RSC24L/7 - RSC24L-CAB - RSC28 C37, 6-7-8 laden - C39, 6-7-8 laden - C39MD - C39SM - C59 - RSC50 - RSC55

5914VU/M

assortiment van 109 gereedschappen voor gereedschapskoffer C14, in bakken van EVA-foam

► universeel gebruik

Aantal/Omschrijving

- 31 30-delig set bits met magnetische snelwissel houder in kunststof box
- 1 bithouderdop
- 13 1/4" dopsleutels, zeskant 4-4,5-5-5,5-6-7-8-9-10-11-12-13-14 mm
- 1 1/4" verlengstuk 150 mm
- 1 1/4" cardangewricht
- 1 1/4" steekhecht
- 1 1/4" wringstaaf met schuifstuk
- 1 1/4" omschakelbare ratel
- 16 1/2" dopsleutels, zeskant 10-11-12-13-14-15-16-17-18-19-21-22-24-27-30-32 mm
- 1 1/2" cardangewricht
- 1 1/2" verlengstuk met kogelkop
- 1 1/2" wringstaaf
- 1 1/2" omschakelbare ratel
- 16 ringsteeksleutels 6-7-8-9-10-11-12-13-14-15-16-17-18-19-21-22 mm
- 9 haakse inbussleutels
- 1 Verstelbare moersleutel 250 mm
- 1 elektricienschaar, rechte bladen
- 1 rolbandmaat 5 mt
- 1 afbreekmes, plat model
- 1 Waterpomp tang met Slip-proof PVC 250 mm
- 1 Zijkniptangen 160 mm
- 1 combinatietang hoogverchroomd 180 mm
- 1 Telefoontang, lange halfronde gegroefde bekken 160 mm
- 3 Schroevendraaiers voor sleufschroeven 3,5x100-5,5x125-6,5x150 mm
- 3 Schroevendraaiers voor Phillips® kruiskop schroeven PH0x60-PH1x80-PH2x100 mm

Beta Nr.	TR
860MIX/A31	MCT1
895/1	MCT1
900	MCT1
900/...	MCT1
900/25	MCT1
900BG/30C	MCT1
900/42	MCT1
900/55	MCT1
920A	MCT1
920/25	MCT1
920AN/125	MCT1
920/42	MCT1
920/55	MCT1
42	MCT2
96/SC9	MCT2
111E	MCT2
1128BMX	MCT2
1692/5	MCT2
1771	MCT2
1048N	MCT3
1082BM	MCT3
1150BM	MCT3
1166BM	MCT3
1260	MCT3
1262	MCT3



MC T1



MC T2



MC T3

€

5914VU/M

1.205,00 059140112

Assortiment aanbevolen in combinatie met gereedschapskoffer C14. Let op: voor een correcte sluiting van de bovenste module van de gereedschapskoffer moet het onderdeel van het gereedschapspaneel worden verwijderd.

5988U/7M

215 delig assortiment gereedschappen in EVA foam inlegbakken

► Universeel gebruik



M01



M100



M213



M33 M86 M136 M234

Aantal/Omschrijving

- 22 ringsteeksleutels 6-7-8-9-10-11-12-13-14-15-16-17-18-19-20-21-22-24-27-30-32-36 mm
- 8 dubbele steeksleutels 6x7-8x9-10x11-12x13-14x15-16x17-18x19-20x22 mm
- 9 haakse inbussleutels \odot 1,5÷10 mm
- 7 bits voor inbusschroeven \odot 4-5-6-7-8-10-12 mm
- 7 bits voor inbusschroeven \odot 4-5-6-7-8-10-12 mm
- 5 bits voor XZN® schroeven \odot 5-6-8-10-12 mm
- 5 bits voor XZN® schroeven \odot 5-6-8-10-12 mm
- 7 bits voor Torx® schroeven \odot T20-T25-T30-T40-T45-T50-T55
- 6 bits voor Torx® schroeven \odot T25-T30-T40-T45-T50-T55
- 7 bits voor Tamper Resistant Torx® schroeven \odot T20-T25-T30-T40-T45-T50-T55
- 1 bihouderdop voor bits 867
- 1 bihouderdop voor bits 867
- 1 bihouderdop
- 1 bihouderdop
- 1 bihouderdop
- 13 1/4" dopsleutels, zeskant \odot 4-4,5-5-5,5-6-7-8-9-10-11-12-13-14 mm
- 9 1/4" Dopsleutels zeskant, lange uitvoering \odot 5-6-7-8-9-10-11-12-13 mm
- 5 1/4" schroevendraaierdoppen voor inbusschroeven \odot 3-4-5-6-7 mm
- 4 Schroevendraaierdoppen voor sleufschroeven \bullet 0,8x4-1x5,5-1,2x6,5-1,2x8 mm
- 4 Schroevendraaierdoppen voor Phillips® kruiskopschroeven \oplus PH1-PH2-PH3-PH4
- 7 Schroevendraaierdoppen voor Torx® schroeven \odot T10-T15-T20-T25-T27-T30-T40
- 1 1/4" verlengstuk 50 mm
- 1 1/4" verlengstuk 100 mm
- 1 1/4" verlengstuk 150 mm
- 1 1/4" cardangewricht
- 1 1/4" steekhecht
- 1 1/4" wringstaaf met schuifstuk
- 1 1/4" omschakelbare ratel \oplus
- 21 1/2" dopsleutels, zeskant \odot 8-10-11-12-13-14-15-16-17-18-19-20-21-22-23-24-26-27-28-30-32 mm
- 1 Verloopdop 1/2" naar 3/8"
- 1 1/2" cardangewricht
- 1 1/2" verlengstuk met kogelkop 125 mm
- 1 1/2" verlengstuk met kogelkop 250 mm
- 1 1/2" wringstaaf
- 1 1/2" omschakelbare ratel \oplus
- 8 1/2" dopsleutels met Torx® profiel \odot 10-12-14-16-18-20-22-24 mm
- 11 Dopsleutels, zeskant lange uitvoering \odot 10-12-13-14-15-16-17-18-19-21-22
- 1 Zijkriptangen, zware uitvoering Z 160 mm
- 1 combinatietang hoogverchromd H 180 mm
- 1 Telefoontang, lange halfronde gegroefde bekken \bullet 160 mm
- 6 Schroevendraaier voor sleufschroeven \bullet 2,5x50-3x75-4x100-5,5x125-6,5x150-8x200 mm
- 1 Schroevendraaier voor sleufschroeven, extra-korte uitvoering \bullet 4x30 mm
- 4 Schroevendraaier voor Phillips® kruiskop schroeven \oplus PH0x60-PH1x80-PH2x100-PH3x150 mm
- 1 Schroevendraaier voor Phillips® kruiskop schroeven. Extra- korte uitvoering \oplus PH1X30 mm
- 12 Schroevendraaiers voor Torx® schroeven \odot T6-T7-T8-T9-T10-T15-T20-T25-T27-T30-T40-T45
- 1 spanningszoeker \bullet
- 2 koudbeitels, geprofileerd model 100-200 mm
- 1 bankhamer 300 g
- 1 kunststof hamer \emptyset 35 mm

Beta Nr.	TR
42	M01
55	M33
96/SC9	M33
867PE	M86
867PEL	M86
867XZN	M86
867XZNL	M86
867TX	M86
867TXL	M86
867RTX	M86
867/1	M86
867/2	M86
895/1	M100
895/3	M100
895/6	M100
900	M100
900L	M100
900ME	M100
900LP	M100
900PH	M100
900TX	M100
900/20	M100
900/20L	M100
900/21	M100
900/25	M100
900BG/30	M100
900/42	M100
900/55	M100
920A	M100
920/15	M100
920/25	M100
920AN/125	M100
920AN/250	M100
920/42	M100
920/55	M100
920FTX	M100
920AL	M100
1084BM	M136
1150BM	M136
1166BM	M136
1201E	M213
1201EN	M213
1202E	M213
1202EN	M213
1207E/TX	M213
1253	M213
35	M234
1370	M234
1390	M234

€

5988U/7M 2.520,00 059881019

Het assortiment is geschikt voor het opbergen in de artikelen RSC23T - RSC24 - RSC24A - RSC24A-XL - RSC24L - RSC24L/CAB RSC28 - C37 - C39 - C39SM - C39MD - C39T - RSC50 - RSC55 - C59

5915VU/0

Assortiment van 35 gereedschappen

► Universeel gebruik

Aantal/Omschrijving

- 1 centerpunt 4 mm
- 1 koudbeitels, geprofileerd model 125 mm
- 8 dubbele steeksleutels 6x7-8x9-10x11-12x13-14x15-16x17-18x19-20x22 mm
- 7 Haakse zeskant stiftsleutels \odot 1,5-2-2,5-3-4-5-6 mm
- 1 Verstelbare moersleutel 150 mm
- 1 Waterpomptang met Slip-proof PVC 250 mm
- 1 Zijkniptangen, handgreep voorzien van dubbel gelaagde anti slip PVC, industriële afwerking \nlessgtr 160 mm
- 1 elektricienschaar, rechte bladen
- 1 Zware combinatietangen, handgreep voorzien van dubbel gelaagde anti slip PVC, industriële afwerking \equiv 180 mm
- 1 Telefoontangen, extra lange halfronde gegroefde bekken, handgreep voorzien van dubbel gelaagde anti slip PVC, industriële afwerking \bullet 160 mm
- 4 Schroevendraaier voor sleufschroeven \bullet 3x75-4x100-5,5x100-6,5x150 mm
- 3 Schroevendraaier voor Phillips® kruiskop schroeven \oplus PH0x60-PH1x80-PH2x100 mm
- 1 bankhamer 300 g
- 1 rolbandmaat 3 m
- 1 afbreekmes, plat model 18 mm
- 1 car service knife
- 1 Ultra heldere LED zaklamp, vervaardigd uit stevig geanodiseerd aluminium, Lichtsterkte tot 500 lumen

Beta Nr.

- 32
- 35
- 55
- 96/BGS7
- 111E
- 1048N
- 1082G
- 1128BMX
- 1150G
- 1166G
- 1201E
- 1202E
- 1370
- 1692/3
- 1771
- 1778SOS
- 1833S

5915VU/0

€



453,00 059151021

Assortiment aanbevolen in combinatie met C4 - C5 - C5S - C6T

5915VU/1

45-delig assortiment gereedschappen

► Universeel gebruik

Aantal/Omschrijving

- 2 doorslagen \varnothing 2-3 mm
- 1 centerpunt \varnothing 4 mm
- 2 koudbeitels 125-150 mm
- 1 ritsbeitels 150 mm
- 14 ringsteeksleutels 6-14 - 17 - 19 - 21 - 22 - 24 mm
- 9 haakse inbussleutels \odot 1,5 - 2 - 2,5 - 3 - 4 - 5 - 6 - 8 - 10 mm
- 1 Verstelbare moersleutel 250 mm
- 1 Waterpomptang met Slip-proof PVC 250 mm
- 1 Zijkniptangen, handgreep voorzien van dubbel gelaagde anti slip PVC, industriële afwerking \nlessgtr 160 mm
- 1 elektricienschaar, rechte bladen
- 1 Zware combinatietangen, handgreep voorzien van dubbel gelaagde anti slip PVC, industriële afwerking \equiv 180 mm
- 1 Telefoontangen, extra lange halfronde gegroefde bekken, handgreep voorzien van dubbel gelaagde anti slip PVC, industriële afwerking \bullet 160 mm
- 4 Schroevendraaier voor sleufschroeven \bullet 3x75 - 4x100 - 5,5x100 - 6,5x150 mm
- 3 Schroevendraaier voor Phillips® kruiskop schroeven \oplus PH0x60 - PH1x80 - PH2x100 mm
- 1 bankhamer 300 g
- 1 rolbandmaat 5 m
- 1 afbreekmes, plat model

Beta Nr.

- 30
- 32
- 34
- 36
- 42
- 96/SC9
- 111E
- 1048N
- 1082G
- 1128BMX
- 1150G
- 1166G
- 1201E
- 1202E
- 1370
- 1692
- 1771

5915VU/1

€



529,00 059151024

Assortiment aanbevolen in combinatie met C8 - C9 - C10 - C10S - C11 - CP15 - CP15L - C16 - CP17 - CP17L - C18



5915VU/2

49-delig assortiment gereedschappen

► Universeel gebruik

Aantal/Omschrijving

- 8 6x7 - 8x9 - 10x11 - 12x13 - 14x15
16x17 - 18x19 - 20x22 mm
- 9 haakse inbussleutels \odot 1,5 - 2 - 2,5 - 3 - 4 - 5 - 6 - 8 - 10 mm
- 13 1/4" dopsleutels, zeskant \odot 4 - 4,5 - 5 - 5,5 - 6 - 7 - 8 - 9 - 10 - 11 - 12 - 13 - 14 mm
- 1 1/4" verlengstuk 150 mm
- 1 1/4" cardangewricht
- 1 1/4" steekhecht
- 1 1/4" wringstaaf met schuifstuk
- 1 1/4" omschakelbare ratel \oplus
- 1 Waterpompplang met Slip-proof PVC 250 mm
- 1 elektricienschaar, rechte bladen
- 1 Zware combinatietangen, handgreep voorzien van dubbel gelaagde anti slip PVC, industriële afwerking \equiv 180 mm
- 4 Schroevendraaier voor sleufschroeven \bullet 3x75 - 4x100 - 5,5x150 - 6,5x150 mm
- 3 Schroevendraaier voor Phillips® kruiskop schroeven \oplus PH0x60 - PH1x80 - PH2x100 mm
- 1 bankhamer 300 g
- 1 rolbandmaat 3 m
- 1 Reserve afbreekmesses 18 mm, verpakt per 10 stuks, voor model 1771, 1771BM, 1771HD
- 1 afbreekmes, plat model 18 mm

Beta Nr.
55/B8N
96/SC9
900
900/21
900/25
900BG/30
900/42
900/55
1048N
1128BMX
1150G
1201E
1202E
1370
1692
1771RL
1771

€ 478,00 059151027

Assortiment aanbevolen in combinatie met C7 - CP15 - C20 - C20L



5915VU/3

Assortiment van 74 gereedschappen

► Universeel onderhoud

Aantal/Omschrijving

- 1 pendrijvers \varnothing 4 mm
- 1 centerpunt \varnothing 4 mm
- 1 koudbeitels 150 mm
- 14 ringsteeksleutels 6-7-8-10-11-12-13-14-15-16-17-19-22-24 mm
- 9 haakse inbussleutels \odot 1,5+10 mm
- 3 haakse stiftsleutels met kracht handgreep \odot 4 - 5 - 6 mm
- 1 Verstelbare moersleutel 250 mm
- 13 1/2" dopsleutels, zeskant \odot 8+17 - 19 - 22 - 24 mm
- 1 1/2" verlengstuk 125 mm
- 1 1/2" verlengstuk 255 mm
- 1 1/2" cardangewricht
- 1 1/2" wringstaaf
- 1 1/2" omschakelbare ratel \oplus
- 8 pijpsleutels, zeskant en lichte uitvoering 6x7 - 8x9 - 10x11 - 12x13 - 14x15 - 16x17 - 18x19 - 20x22 mm
- 2 wringstaven voor pijpsleutels
- 1 Waterpompplangen met doorgestoken scharnier 250 mm
- 1 Verstelbare griptang 240 mm
- 1 Zijkniptangen, handgreep voorzien van dubbel gelaagde anti slip PVC, industriële afwerking ∇ 160 mm
- 1 elektricienschaar, rechte bladen
- 1 Zware combinatietangen, handgreep voorzien van dubbel gelaagde anti slip PVC, industriële afwerking \equiv 180 mm
- 1 Telefoon tangen, extra lange halfronde gegroefde bekken, handgreep voorzien van dubbel gelaagde anti slip PVC, industriële afwerking \bullet 160 mm
- 4 Schroevendraaier voor sleufschroeven \bullet 3x75 - 4x100 - 5,5x150 - 6,5x150 mm
- 3 Schroevendraaier voor Phillips® kruiskop schroeven \oplus PH0x60 - PH1x80 - PH2x100 mm
- 1 bankhamer 400 g
- 1 rolbandmaat 5 m
- 1 zaagbeugel
- 1 kunststof oliekan met pomp 150 cc
- 1 afbreekmes, plat model

Beta Nr.
31
32
34
42
96/SC9
96T
111E
920A
920/21
920/22
920/25
920/42
920/55
935
940
1048VN
1052
1084G
1128BMX
1150G
1166G
1201E
1202E
1370
1692
1726
1754
1771

€ 981,00 059151028

Assortiment aanbevolen in combinatie met C7 - C9 - C10 - C10S - C11 - CP15L - C16 - CP17 - CP17L - C19 - C19L - C20 - C20L

5915VU/4

80-delig assortiment gereedschappen

► Universeel gebruik

Aantal/Omschrijving

- 1 pendrijvers Ø 4 mm
- 1 centerpunt Ø 4 mm
- 1 koudbeitels 150 mm
- 15 ringsteeksleutels 6-7-8-9-10-11-12-13-14-15-16-17-19-22-24 mm
- 9 haakse inbussleutels \odot 1,5+10 mm
- 1 Verstelbare moersleutel 250 mm
- 13 1/2" dopsleutels, zeskant \odot 8+17 - 19 - 22 - 24 mm
- 1 1/2" verlengstuk 255 mm
- 1 1/2" cardangewricht
- 1 1/2" wringstaaf
- 1 1/2" omschakelbare ratel \otimes
- 17 gebogen pijpsleutels, twaalfkant en zeskant 6+22 mm
- 1 Waterpomptang met Slip-proof PVC 250 mm
- 1 Verstelbare griptang 240 mm
- 1 Zijkniptangen, twee componenten handgreep, industriële afwerking \leq 160 mm
- 1 elektricienschaar, rechte bladen
- 1 Zware combinatietangen, twee componenten handgreep, industriële afwerking \equiv 180 mm
- 1 Telefoontangen, extra lange halfronde gegroefde bekken, twee componenten handgreep, industriële afwerking \bullet 160 mm
- 4 Schroevendraaier voor sleufschroeven \bullet 3x75 - 4x100 - 5,5x150 - 6,5x150 mm
- 3 Schroevendraaier voor Phillips® kruiskop schroeven \oplus PH0x60 - PH1x80 - PH2x100 mm
- 1 bankhamer, Frans model houten steel 32 mm
- 1 rolbandmaat 5 m
- 1 zaagbeugel
- 1 kunststof oliekan met pomp 150 cc
- 1 afbreekmes, plat model

Beta Nr.

- 31
- 32
- 34
- 42
- 96/SC9
- 111E
- 920A
- 920/22
- 920/25
- 920/42
- 920/55
- 932/S17
- 1048N
- 1052
- 1084GBM
- 1128BMX
- 1150GBM
- 1166GBM
- 1201E
- 1202E
- 1370F
- 1692
- 1726
- 1754
- 1771



€

5915VU/4 1.265,00 059151045

Assortiment aanbevolen in combinatie met C20 - C20L

5915VU/5

Assortiment van 111 gereedschappen

► Universeel gebruik

Aantal/Omschrijving

- 1 pendrijvers Ø 4 mm
- 1 centerpunt Ø 4 mm
- 1 koudbeitels 150 mm
- 17 ringsteeksleutels 6-7-8-9-10-11-12-13-14-15-16-17-18-19-20-21-22 mm
- 8 dubbele steeksleutels 6x7-8x9-10x11-12x13-14x15-16x17-18x19-20x22 mm
- 9 Haakse stiftsleutels met kogelkop \odot
- 1 Verstelbare moersleutel 250 mm
- 39 11 zeskant dopsleutels, 20 bits en 8 toebehoren
- 13 Doppendoos met 11 dopsleutels en 2 toebehoren
- 1 Waterpomptang met Slip-proof PVC 250 mm
- 1 Verstelbare griptang 240 mm
- 1 Zijkniptangen, handgreep voorzien van dubbel gelaagde anti slip PVC, industriële afwerking \leq 160 mm
- 1 Moniertangen 220 mm
- 1 elektricienschaar, rechte bladen
- 1 Zware combinatietangen, handgreep voorzien van dubbel gelaagde anti slip PVC, industriële afwerking \equiv 180 mm
- 1 Telefoontangen, extra lange halfronde gegroefde bekken, handgreep voorzien van dubbel gelaagde anti slip PVC, industriële afwerking \bullet 160 mm
- 4 Schroevendraaier voor sleufschroeven \bullet 3x75 - 4x100 - 5,5x100 - 6,5x150 mm
- 3 Schroevendraaier voor Phillips® kruiskop schroeven \oplus PH0x60 - PH1x80 - PH2x100 mm
- 1 bankhamer 300 g
- 1 kunststof hamer Ø 35 mm
- 1 rolbandmaat 3 m
- 1 halfzoete vijlen
- 1 zaagbeugel 440 mm
- 1 afbreekmes, plat model 18 mm
- 1 LED inspectielamp, vervaardigd uit stevig geanodiseerd aluminium

Beta Nr.

- 31
- 32
- 34
- 42
- 55/S8
- 96BPC/SC9
- 111E
- 900/C11
- 920A/C11
- 1048N
- 1052
- 1082G
- 1098
- 1128BMX
- 1150G
- 1166G
- 1201E
- 1202E
- 1370
- 1390
- 1692/3
- 1719BMA8/M
- 1726
- 1771BM
- 1833XS/2



€

5915VU/5 1.265,00 059151046

Assortiment aanbevolen in combinatie met C12 - C41S - C41H - C42S - C42H

5915VU/AS

Assortiment van 68 gereedschappen

► Universeel onderhoud

Aantal/Omschrijving

- 1 pendrijvers Ø 4 mm
- 1 centerpunt Ø 4 mm
- 1 koudbeitels 150 mm
- 13 ringsteeksleutels 1/4 - 5/16 - 3/8 - 7/16 - 1/2 - 9/16 - 5/8 - 11/16 - 3/4 - 13/16 - 7/8 - 15/16 - 1"
- 8 ringsleutels, diepgebogen 1/4"+1"
- 9 ○ 3/64"+3/8"
- 1 Verstelbare moersleutel 250 mm
- 11 1/2" dopsleutels, twaalfkant ○ 3/8 - 7/16 - 1/2 - 9/16 - 5/8 - 11/16 - 3/4 - 13/16 - 7/8 - 15/16 - 1"
- 1 1/2" verlengstuk 125 mm
- 1 1/2" verlengstuk 255 mm
- 1 1/2" cardangewricht
- 1 1/2" wringstaaf
- 1 1/2" omschakelbare ratel ⊗
- 1 Waterpomptang met Slip-proof PVC 250 mm
- 1 Verstelbare griptang 240 mm
- 1 Zijkniptangen, twee componenten handgreep, industriële afwerking ≡ 160 mm
- 1 elektricienschaar, rechte bladen
- 1 Zware combinatietangen, twee componenten handgreep, industriële afwerking ≡ 180 mm
- 1 Telefoon tangen, extra lange halfronde gegroefde bekken, twee componenten handgreep, industriële afwerking ● 160 mm
- 4 Schroevendraaier voor sleufschroeven ● 3x75 - 4x100 - 5,5x150 - 6,5x150 mm
- 3 Schroevendraaier voor Phillips® kruiskop schroeven ⊕ PH0x60 - PH1x80 - PH2x100 mm
- 1 bankhamer 300 g
- 1 rolbandmaat 5 m
- 1 zaagbeugel
- 1 kunststof oliekan met pomp 150 cc
- 1 afbreekmes, plat model

Beta Nr.
31
32
34
42AS
90AS/8
96AS/SC9
111E
920AS
920/21
920/22
920/25
920/42
920/55
1048N
1052
1084GBM
1128BMX
1150GBM
1166GBM
1201E
1202E
1370
1692
1726
1754
1771

€ 

5915VU/AS 1.087,00 059151032

Assortiment aanbevolen in combinatie met C10 - C20 - C20L



5927VU/M

Assortiment van 108 gereedschappen in voorgevormde EVA foam inlegbakken

► Universeel gebruik

Aantal/Omschrijving

- 16 ringsteeksleutels 6-7-8-9-10-11-12-13-14-15-16-17-18-19-21-22 mm
- 1 Zijkniptangen, zware uitvoering ≡ 160 mm
- 9 haakse inbussleutels ○ 1,5-2-2,5-3-4-5-6-8-10 mm
- 1 combinatietang hoogverchroomd ≡ 180 mm
- 1 Telefoon tang, lange halfronde gegroefde bekken ● 160 mm
- 3 Schroevendraaier voor sleufschroeven ● 3,5x100-5,5x150-6,5x150 mm
- 3 Schroevendraaier voor Phillips® kruiskop schroeven ⊕ PH0x3x60-PH1x4,5x80-PH2x6x100 mm
- 31 30-delig set bits met magnetische snelwissel houder in kunststof box ○ ● ⊕ ⊕ ⊕ ⊕
- 1 Waterpomptang met Slip-proof PVC 250 mm
- 1 bankhamer 300 mm
- 1 centerpunt 4 mm
- 1 ritsbeitels 4 mm
- 13 1/4" dopsleutels, zeskant ○ 4-4,5-5-5,5-6-7-8-9-10-11-12-13-14 mm
- 1 1/4" verlengstuk 150 mm
- 1 1/4" cardangewricht
- 1 1/4" steekhecht
- 1 1/4" wringstaaf met schuifstuk
- 1 1/4" omschakelbare ratel ⊗
- 16 1/2" dopsleutels, zeskant ○ 10-11-12-13-14-15-16-17-18-19-21-22-24-27-30-32 mm
- 1 1/2" cardangewricht
- 1 1/2" verlengstuk met kogelkop 125 mm
- 1 1/4" wringstaaf met schuifstuk
- 1 1/2" omschakelbare ratel ⊗
- 1 bithouderdop

Beta Nr.	TR
42	MC10
1084BM	MC10
96/SC9	MC10
1150BM	MC10
1166BM	MC10
1201E	MC10
1202E	MC10
860MIX/A31	MC20
1048N	MC20
1370	MC20
32	MC20
36	MC20
900	MC20
900/21	MC20
900/25	MC20
900BG/30C	MC20
900/42	MC20
900/55	MC20
920A	MC20
920/25	MC20
920AN/125	MC20
900/42	MC20
920/55	MC20
895/1	MC20

€ 

5927VU/M 1.082,00 059271021

Assortiment aanbevolen in combinatie met RSC22 - C27S - RSC23 - RSC23C



MC10



MC20

VP-LS

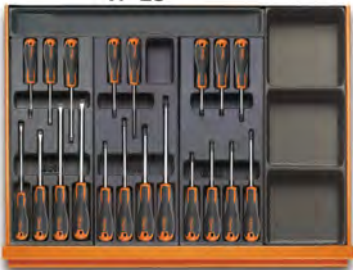

T211 T213 T216 VP3-SC
VP-LS



T145 T153 T137 VP3-SC
VP-LD



T85



T234 T294

VP-LS



T80 T239 VP3-SC
VP-LS



T01 T33 VP3-SC
VP-LD



T68 T236



T50

5938U/2T

Assortiment van 210 gereedschappen in voorgevormde ABS inlegbakken

► Universeel gebruik

Aantal/Omschrijving

- 7 Schroevendraaier voor sleufschroeven ● 2,5x50 - 3x75 - 3,5x100 - 4x125
5,5x100 - 5,5x150 - 6,5x150 mm
- 6 Schroevendraaier voor Phillips® kruiskop schroeven ⊕ PH0x60-PH1x80-PH1x120-PH2x100-
PH2x150-PH3x150 mm
- 7 Schroevendraaiers voor Torx® schroeven ⊕ T6-T7-T8-T9-T10-T15-T20

- 1 borgveertangen, inwendig rechte punten ○ 180 mm
- 1 borgveertangen, inwendig 90° gebogen punten ○ 170 mm
- 1 borgveertangen, uitwendig rechte punten ● 175 mm
- 1 borgveertangen, uitwendig 90° gebogen punten ● 175 mm
- 1 Waterpomptang met Slip-proof PVC 250 mm
- 1 Verstelbare griptang 240 mm
- 1 Zijknijptangen, zware uitvoering ≧ 160 mm
- 1 combinatietang hoogverchroomd ≧ 180 mm
- 1 Telefoontang, lange halfronde gegroefde bekken ● 160 mm
- 1 Omschakelbare ratelssleutel voor bits 1/4x5/16
- 13 1/4" dopsleutels, zeskant ○ 4-4,5-5-5,5-6-7-8-9-10-11-12-13-14 mm
- 1 1/4" omschakelbare ratel ⊗ 125 mm
- 1 1/4" wringstaaf met schuifstuk 115 mm
- 1 1/4" steekhecht 176 mm
- 1 1/4" cardangewricht 41 mm
- 1 1/4" verlengstuk 150 mm
- 1 Magnetische bithouder met handgreep 230 mm
- 5 bits voor Spanner schroeven ⊕ 4-6-8-10-12 mm
- 8 bits voor Torq-Set® schroeven ⊕ 0-1-2-3-4-5-6-8 mm
- 6 bits voor Tri-Wing® schroeven ⊕ 1-2-3-4-5-6 mm
- 8 Bits voor Tamper Resistant Torx® schroeven ⊕ T9-T10-T15-T20-T25-T27-T30-T40
- 11 bits voor Torx® schroeven ⊕ T6-T7-T8-T9-T10-T15-T20-T25-T27-T30-T40
- 3 Bits voor Pozidriv®- Supadriv® kruiskopschroeven ⊕ PZ1 - PZ2 - PZ3
- 4 Bits voor Phillips® kruiskopschroeven ⊕ PH0 - PH1 - PH2 - PH3
- 8 Bits voor inbusschroeven ○ 2 - 2,5 - 3 - 4 - 5 - 6 - 8 - 10 mm
- 7 Bits voor sleufschroeven ● 0,5x3 - 0,6x4,5 - 0,8x5,5 - 1x5,5 - 1,2x6,5 - 1,2x8 - 1,6x8 mm
- 2 koudbeitels, geprofileerd model 100 - 200 mm
- 1 bankhamer 300 g
- 1 kunststof hamer Ø 35 mm
- 1 rolbandmaat 5 m
- 1 mini zaagbeugel
- 1 Reserve afbreekmesses 18 mm, verpakt per 10 stuks, voor model 1771, 1771BM, 1771HD
- 1 afbreekmes, plat model
- 19 1/2" dopsleutels, zeskant ○ 10 - 11 - 12+19 - 20 - 21 - 22 - 23 - 24 - 26 - 27 - 30 - 32 mm
- 5 1/2" schroevendraaierdoppen voor inbusschroeven ○ 5 - 6 - 8 - 10 - 12 mm
- 1 1/2" verlengstuk 125 mm
- 1 1/2" verlengstuk 255 mm
- 1 1/2" cardangewricht
- 1 1/2" wringstaaf
- 1 1/2" omschakelbare ratel ⊗
- 1 centerpunt Ø 4 mm
- 6 Pendrijvers met handvat 2-3-4-5-6-8 mm
- 17 ringsteeksleutels 6-7-8-10-11-12-13-14-16-17-18-19-21-22-24-27-30 mm
- 8 dubbele steeksleutels 6x7 - 8x9 - 10x11 - 12x13 - 14x15 - 16x17 - 18x19 - 20x22 mm
- 9 haakse inbussleutels ○
- 6 inbus T-sleutels met zeskant profiel op drie zijden 2,5 - 3 - 4 - 5 - 6 - 8 mm
- 5 halfzoete vijlen 200 mm
- 11 haakse stiftsleutels met kracht handgreep ○ 2 - 2,5 - 3 - 3,5 - 4 - 4,5 - 5 - 6 mm

Beta Nr.	TR
1201E	T211
1202E	T213
1207E/TX	T216
1032	T145
1034	T145
1036	T145
1038	T145
1048N	T153
1052	T153
1084BM	T137
1150BM	T137
1166BM	T137
194	T85
900	T85
900/55	T85
900/42	T85
900BG/30	T85
900/25	T85
900/21	T85
851SR	T85
861SP	T85
861TQS	T85
861TRW	T85
861RTX	T85
861TX	T85
861PZ	T85
861PH	T85
861PE	T85
861LP	T85
35	T234
1370	T234
1390	T234
1692	T294
1725SCR	T294
1771RL	T294
1771	T294
920A	T80
920ME	T80
920/21	T80
920/22	T80
920/25	T80
920/42	T80
920/55	T80
32	T239
31BM	T239
42	T01
55	T33
96/SC9	T33
951	T68
1719BMA8/S5	T236
96T	T50
VP-3SC	VP-3SC
VP-LS	VP-LS
VP-LD	VP-LD

€

5938U/2T 2.640,00 059381062

Assortiment aanbevolen in combinatie met C38



5957U-P

133-delig assortiment gereedschappen

► Universeel gebruik

Aantal/Omschrijving	Beta Nr.
6 pendrijvers 2 ÷ 8 mm	31/SP6
6 beitels in houder	38/SP6
17 Ringsteeksleutels 6÷22 - 24 - 27 - 30 mm	42/S17X
12 dubbele steeksleutels 6x7 ÷ 30x32 mm	55/S12X
8 haakse stiftsleutels met kracht handgreep 2 + 10 mm	96T/S8
8 haakse stiftsleutels voor Torx® schroeven ⚫ T9 ÷ T40	97TX/SC8
1 Verstelbare moersleutel 250 mm	111E
13 1/2" zeskant dopsleutels op dophouder ⚫ 10 ÷ 22 mm	920A/SB13
8 1/2" zeskant dopsleutels op dophouder ⚫ 23 ÷ 32 mm	920A/SB8
7 Schroevendraaierdoppen voor sleuf en voor Phillips® kruiskopschroeven ⚫	920LH/SB7
⚫ 1,2x65 - 1,2x8 - 1,6x9 - 2x12mm - PH1-PH2-PH3	
1 borgveertangen, inwendig rechte punten ⚫ 180 mm	1032
1 borgveertangen, inwendig 90° gebogen punten ⚫ 170 mm	1034
1 borgveertangen, uitwendig rechte punten ⚫ 175 mm	1036
1 borgveertangen, uitwendig 90° gebogen punten ⚫ 175 mm	1038
1 Waterpomptang met Slip-proof PVC 250 mm	1048N
1 Verstelbare griptang 240 mm	1052
1 blikshaar 250 mm	1112
1 elektricienschaar, rechte bladen	1128BMX
8 schroevendraaierdoppen 2,5x50 - 3x75 - 4x100 - 5,5x125 - 6,5x150 - PH0 - PH1 - PH2	1263/D8
2 bankhamer 300 - 600 g	1370
1 kunststof hamer 35	1390
1 rolbandmaat 5 m	1692/5
1 flexibele magneet	1712E/2
1 schraapstaal, half rond model 200 mm	1717A
1 schraapstaal, driekantig model 200 mm	1717B
5 halfzoete vijlen 200 mm	1719BMA8/S5
1 metalen oliekan met pomp, 200 cc	1751N
1 afbreekmes, plat model	1771BM
1 1/2" verlengstuk 125 mm	920/21
1 1/2" verlengstuk 250 mm	920/22
1 1/2" cardangewricht	920/25
1 1/2" wringstaaf	920/42
1 1/2" omschakelbare ratel ⚫	920/55
1 puntschop	963
1 Zijknijptangen ≤ 160 mm	1082BM
1 Zijknijptangen, zware uitvoering ≤ 160 mm	1084BM
1 hefboom kopknijptang ≤ 180 mm	1092V
1 combinatietang hoogverchroomd = 180 mm	1150BM
1 Telefoontang, lange halfronde gegroefde bekken ⚫ 160 mm	1166BM
1 Telefoontang, lange halfronde gebogen bekken ⚫ 160 mm	1168BM
2 Schroevendraaiers voor sleufschroeven ⚫ 8x200 - 10x200 mm	1260
1 Schroevendraaiers voor Phillips® kruiskop schroeven ⚫ PH3 8x150mm	1262
1 Schuifmaat	1650
1 zaagbeugel 420 mm	1725

€



5957U-P

2.820,00 059571004

Assortiment aanbevolen in combinatie met C57S A - C57S B - C57SP - RSC50 PS - RSC50 - C55PS - C55PSE - RSC55



5958U

85-delig assortiment gereedschappen

► Universeel gebruik

Aantal/Omschrijving	Beta Nr.
17 ringsteeksleutels 6÷22 mm	42
12 haakse inbussleutels \odot 2÷10 mm	96N/SC12
13 1/2" zeskant dopsleutels op dophouder \odot 10÷22 mm	920A/SB13
8 1/2" zeskant dopsleutels op dophouder \odot 23÷32 mm	920A/SB8
1 1/2" verlengstuk 125 mm	920/21
1 1/2" verlengstuk 255 mm	920/22
1 1/2" cardangewricht	920/25
1 1/2" wringstaaf	920/42
1 1/2" omschakelbare ratel \oplus	920/55
1 borgveertangen, inwendig rechte punten \odot 180 mm	1032
1 borgveertangen, uitwendig rechte punten \bullet 175 mm	1036
1 Waterpomptang met Slip-proof PVC 250 mm	1048N
1 Verstelbare griptang 240 mm	1052
1 Zijkniptangen, zware uitvoering ∇ 160 mm	1084BM
1 elektricienschaar, rechte bladen	1128BMX
1 combinatietang hoogverchroomd \equiv 180 mm	1150BM
1 Telefoontang, lange halfronde gegroefde bekken \bullet 160 mm	1166BM
7 Schroevendraaiers voor sleufschroeven \bullet 3x75 - 3,5x100 - 4x125 5,5x150 - 6,5x150 - 8x200 - 10x200 mm	1260
4 schroevendraaiers voor Phillips® kruiskopschroeven \oplus PH0x60 - PH1x80 - PH2x100 - PH3x150 mm	1262/S4
1 bankhamer 300 g	1370
1 kunststof hamer \varnothing 35 mm	1390
1 rolbandmaat 5 m	1692
5 5-delig set halfzoeten vijlen met handgreep 200 mm	1719BMA..S5
1 zaagbeugel	1725
1 kunststof oliekan met pomp 150 cc	1754
1 afbreekmes, plat model	1771

€



5958U

1.445,00 059581008

Assortiment aanbevolen in combinatie met C58P - C45PRO - RSC50 - RSC55



5990V1

44-delig assortiment gereedschap voor transportkoffer COMBO C99V1, in EVA foam inlegbak

► Universeel gebruik

Aantal/Omschrijving

- 9 Haakse stiftsleutels met kogelkop ○
- 1 afbreekmes, plat model 18 mm
- 1 Waterpomptang met Slip-proof PVC 250 mm
- 6 set van 6 pendrijvers in foudraal van duurzaam polyester
- 3 Schroevendraaiers voor sleufschroeven ● 3,5x100-5,5x125-6,5x150 mm
- 3 Schroevendraaiers voor Phillips® kruiskop schroeven ⊕ PH0x60-PH1x80-PH2x100 mm
- 1 elektricienschaar, rechte bladen
- 16 ringsteeksleutels 6-7-8-9-10-11-12-13-14-15-16-17-18-19-21-22 mm
- 1 rolbandmaat 5 mt
- 1 bankhamer 300 g
- 1 ⚡ 160 mm
- 1 Zware combinatietangen, twee componenten handgreep, industriële afwerking ≡ 180 mm

Beta Nr.

- 96BPC/SC9 1771
- 1048N 1048N
- 38/B6N 38/B6N
- 1260 1260
- 1262 1262
- 1128BMX 1128BMX
- 42 42
- 1692/5 1692/5
- 1370 1370
- 1082GBM 1082GBM
- 1150GBM 1150GBM

€

5990V1 640,00 059900001

Assortiment is aanbevolen in combinatie met C99V1



5990V3

116-delig assortiment gereedschap voor de transportkoffer COMBO C99V3/2C, in EVA foam inlegbak

► Autoreparatie

Aantal/Omschrijving

- 5 haakse stiftsleutels met kracht handgreep
- 1 Verstelbare moersleutel 250 mm
- 1 1/4" steekhecht
- 1 spanningszoeker ●
- 1 Zak waterpas met magnetisch V
- 1 LED inspectielamp, vervaardigd uit stevig geanodiseerd aluminium
- 31 30-delig set bits met magnetische snelwissel houder in kunststof box ● ○ ⊕ ⊕ ⊕
- 1 bithouderdop
- 12 1/4" dopsleutels, zeskant ○ 4-4,5-5-5,5-6-7-8-9-10-11-12-13 mm
- 1 1/4" verlengstuk 50 mm
- 1 1/4" verlengstuk 100 mm
- 1 1/4" wringstaaf met schuifstuk
- 1 1/4" ratelsleutel, 72 tands mechanisme ⊗
- 38 Microschroevendraaier met 36 verwisselbare 4-mm bits en magnetisch verlengstuk
- 1 kunststof hamer Ø 35mm
- 1 1/4" cardangewricht
- 13 1/2" dopsleutels, zeskant ○ 10-11-12-13-14-15-16-17-18-19-20-21-22 mm
- 1 1/2" verlengstuk 125 mm
- 1 1/2" verlengstuk 255 mm
- 1 1/2" cardangewricht
- 1 1/2" wringstaaf
- 1 1/2" omschakelbare ratel ⊗

Beta Nr.

- 96T/S5P 96T/S5P
- 111E 111E
- 900BG/30 900BG/30
- 1253 1253
- 1695XS 1695XS
- 1833XS/2 1833XS/2
- 860MIX/A31 860MIX/A31
- 895 895
- 900 900
- 900/20 900/20
- 900/20L 900/20L
- 900/42 900/42
- 900/55Z 900/55Z
- 1256/C36-2 1256/C36-2
- 1390 1390
- 900/25 900/25
- 920A 920A
- 920/21 920/21
- 920/22 920/22
- 920/25 920/25
- 920/42 920/42
- 920/55 920/55

€

5990V3 947,00 059900003

Assortiment is aanbevolen in combinatie met C99V3/2C

Beta



5980U/BIKE

Assortiment van 90 gereedschappen

► Fietsonderhoud

Aantal/Omschrijving	Beta Nr.
5 ringsteeksleutels 8-9-10-13-14 mm	42
9 Haakse stiftsleutels met kogelkop gebruneerd \odot 1,5-2-2,5-3-4-5-6-8-10 mm	96BP/SC9
8 haakse stiftsleutels met kracht handgreep 2-2,5-3-4-5-6-8-10 mm	96T/S8
8 schroevendraaiers voor Torx® schroeven \odot T8-T10-T15-T20-T25-T27-T30-T40	97TTX/S8
1 Verstelbare moersleutel met extra brede opening, verchromd, korte uitvoering 170 mm	111CM
1 pijpsnijder voor koperen en licht metalen pijp	334
1 Momentsleutels me klikmechanisme 2±10 Nm	605E
13 \odot 4-4,5-5-5,5-6-7-8-9-10-11-12-13-14 mm	900/SB13
1 1/4" verlengstuk	900/21
1 1/4" cardangewricht	900/25
1 1/4" omschakelbare ratel \oplus	900/55
1 Zijkniptangen, handgreep voorzien van dubbel gelaagde anti slip PVC, industriële afwerking ∇ 160 mm	1082G
1 elektriciens schaar rechte bladen 145 mm	1128BM
1 Zware combinatietangen, handgreep voorzien van dubbel gelaagde anti slip PVC, industriële afwerking \equiv 180 mm	1150G
1 Telefoontangen, extra lange halfronde gegroefde bekken, handgreep voorzien van dubbel gelaagde anti slip PVC, industriële afwerking \bullet 180 mm	1166G
7 3x75-4x125-5,5x150-6,5x150-PH0x60-PH1x80-PH2x100 mm	1203E/D
1 bankhamer 300 g	1370
1 kunststof hamer \varnothing 35 mm	1390
1 Schuifmaat 150 mm	1650
1 rolbandmaat 3 m	1692/3
1 Halfzoeten vijlen, plat met handgreep 200 mm	1719BMA...P
1 Halfzoeten vijlen, half rond met handgreep 200 mm	1719BMA...M
1 Halfzoeten vijlen, rond met handgreep 200 mm	1719BMA...R
1 zaagbeugel 300 mm	1725
1 afbreekmes, plat model	1771
1 Ketting slijtage meetsleutel 120 mm	3935
1 Kettingschakel tang 170 mm	3937
7 7-delig set conussleutels 13-14-15-16-17-18-19 mm	3952/S7
1 Pedaalsleutel 15 mm	3953
1 Spaaknippelspanner, zwart, 3,2 mm \square	3961 3,2
1 Spaaknippelspanner, groen, 3,3 mm \square	3961 3,3
1 Spaaknippelspanner, rood, 3,5 mm \square 3	3961 3,5
1 Professionele spaaknippelsleutel, 3,2 - 4,0 mm \square 3,2 - 4,0 mm	3961U
1 Tandwielverwijderaar met ketting 289 mm	3967
1 Bandenlichter 200 mm	3969
3 Set van 3 bandenlichters, vervaardigd uit kunststof 113 mm	3969K3
1 Hefboom voor het terugduwen van remblokken 222 mm	3991
1 Remschijf sleutel 234 mm	3992

€ 

5980U/BIKE 1.655,00 059801040

Assortiment aanbevolen in combinatie met C16 - CP17 - CP17L - C20L

5980U/BIKE-M

assortiment van 106 fietsreparatie- en onderhoudsgereedschappen



M05

M50

M55



M137

M234

M236

M294



M213



M400



M401

Aantal/Omschrijving

- 16 Ringsteeksleutels 6-7-8-9-10-11-12-13-14-15-16-17-18-19-20-21 mm
- 8 haakse stiftsleutels met kracht handgreep 2-2,5-3-4-5-6-7-8 mm
- 5 schroevendraaiers voor Torx® schroeven TX10-TX15-TX20-TX25-TX30
- 1 Zijknijptangen, zware uitvoering 160 mm
- 1 Combinatietangen 160 mm
- 1 Telefoontang, lange platte gegroefde bekken 160 mm
- 6 Schroevendraaier voor sleufschroeven 2,5x50-3x75-4x100-5,5x125-6,5x150-8x200 mm
- 1 Schroevendraaier voor sleufschroeven, extra-korte uitvoering 4x30 mm
- 4 Schroevendraaier voor Phillips® kruiskop schroeven PH0x60-PH1x80-PH2x100-PH3x150 mm
- 1 Schroevendraaier voor Phillips® kruiskop schroeven. Extra- korte uitvoering 4,5x30 mm
- 12 Schroevendraaiers voor Torx® schroeven TX6-TX7-TX8-TX9-TX10-TX15-TX20-T25-TX27-TX30-TX40-TX45
- 1 spanningszoeker
- 1 bankhamer 300 g
- 1 kunststof hamer 35 mm
- 2 koudbeitels, geprofileerd model 100-200 mm
- 1 5-delig set halfzoeten vijlen met handgreep 200 mm
- 1 rolbandmaat 5 m
- 1 mini zaagbeugel 250 mm
- 1 afbreekmes, plat model
- 1 Reserve afbreekmessen 18 mm, verpakt per 10 stuks, voor model 1771, 1771BM, 1771HD
- 1 Professionele kettingpons geschikt voor kettingen van 5 tot 11 speed.
- 1 Ketting slijtage meetsleutel
- 1 Kettingeschakel tang
- 7 Conussleutel 13-14-15-16-17-18-19 mm
- 1 Spaaknippelspanner, zwart, 3,2 mm □ 3,2 mm
- 1 Spaaknippelspanner, groen, 3,3 mm □ 3,3 mm
- 1 Spaaknippelspanner, rood, 3,5 mm □ 3,5 mm
- 1 Professionele spaaknippelsleutel, 3,2 - 4,0 mm □ 3,2-4,0 mm
- 1 Bandenlichter
- 1 Set van 3 bandenlichters, vervaardigd uit kunststof
- 1 16-punts trapasverwijderaar dopsleutel 39 mm
- 1 16-punts trapasverwijderaar dopsleutel 41 mm
- 1 16-punts trapasverwijderaar dopsleutel 46 mm
- 1 20-punts trapasverwijderaar sleutel met centreer pin, vernikkeld 31,5 mm
- 1 BMX freewheel verwijderaar, 4 noks 35 mm
- 1 Shimano freewheel verwijderaar 22,8 mm
- 1 Shimano freewheel verwijderaar, cassettelocking met geleiderpen 23,5 mm
- 1 Campagnolo freewheel verwijderaar, met geleiderpen 23 mm
- 1 Hefboom voor het terugduwen van remblokken
- 1 Remschijf sleutel
- 1 derailleur uitlijner
- 1 Cranktrekker
- 1 Pedaalessleutel
- 2 Dubbele steeksleutels voor universeel balhoofd 30x32-32x36 mm
- 1 Tandwielverwijderaar met ketting
- 1 Sleutel voor Shimano kunststof afdekoppen

Beta Nr.	TR
42	M05
96T	M50
97TTX	M55
1084	M137
1150	M137
1166	M137
1201E	M213
1201EN	M213
1202E	M213
1202EN	M213
1207E/TX	M213
1253	M213
1370	M234
1390	M234
35	M234
1719BMA...S5	M236
1692	M294
1725CR	M294
1771	M294
1771RL	M294
3932U	M400
3935	M400
3937	M400
3952	M400
3961 3,2	M400
3961 3,3	M400
3961 3,5	M400
3961U	M400
3969	M400
3969K3	M400
3973/1	M400
3973/2	M400
3973/3	M400
3973/4	M400
3984/1	M400
3984/2	M400
3984/3	M400
3984/4	M400
3991	M400
3992	M400
3992	M401
3948	M401
3953	M401
3955	M401
3967	M401
3971	M401

€

5980U/BIKE-M 2.165,00 059801050

5988H/7M

Assortiment van 333 gereedschappen in voorgevormde EVA foam inlegbakken

► Auto herstel

Aantal/Omschrijving

- 13 Dopsleutels, zeskant, lange uitvoering ○ 8-9-10-11-12-13-14-15-16-17-19-21-22 mm
- 16 Dopsleutels, zeskant lange uitvoering ○ 10-12-13-14-15-16-17-18-19-21-22-23-24-27-30-32 mm
- 7 1/2" dopsleutels met Torx® profiel ○ E12-E14-E16-E18-E20-E22-E24
- 10 Dopsleutels voor binnenzeskant schroeven ○ 5-6-6L-7-8-8L-10-10L-12-12L mm
- 13 1/2" schroevendraaierdoppen met Torx® profiel ○ T20-T25-T27-T30-T30L-T40-T40L-T45-T50-T50L-T55-T60-T60L
- 8 Schroevendraaierdoppen met XZN® profiel ○ 5-6-6L-8-8L-10-10L-12L mm
- 18 ringsteeksleutels 6-7-8-9-10-11-12-13-14-15-16-17-18-19-21-22-24-27 mm
- 7 ringsleutels, diepgebogen 6x7-8x9-10x11-12x13-14x15-16x17-18x19 mm
- 1 Dophouder 1/4" passend in ringratelsleutel 10 mm
- 1 Dophouder 3/8" passend in ringratelsleutel 13 mm
- 1 Dophouder 1/2" passend in ringratelsleutel 19 mm
- 12 Omschakelbare ratelringsteeksleutels 8-9-10-11-12-13-14-15-16-17-18-19 mm
- 9 Haakse stiftsleutels met kogelkop ○ 1,5-2-2,5-3-4-5-6-8-10 mm
- 1 bithouderdop ○ 1/4-□1/4
- 1 bithouderdop ○ 1/4-□3/8
- 1 bithouderdop ○ 5/16-□1/2
- 13 1/4" dopsleutels, zeskant ○ 4-4,5-5-5,5-6-7-8-9-10-11-12-13-14 mm
- 9 1/4" Dopsleutels zeskant, lange uitvoering ○ 5-6-7-8-9-10-11-12-13 mm
- 4 Schroevendraaierdoppen voor sleufschroeven ● 0,8x4-1x5,5-1,2x6,5-1,2x8 mm
- 5 1/4" schroevendraaierdoppen voor inbusschroeven ○ 3-4-5-6-7 mm
- 4 Schroevendraaierdoppen voor Phillips® kruiskopschroeven ● PH1-PH2-PH3-PH4
- 7 Schroevendraaierdoppen voor Torx® schroeven ○ T10-T15-T20-T25-T27-T30-T40
- 1 Verloopstuk 1/4" naar 3/8" □1/4-■3/8
- 3 1/4" verlengstuk 50-100-150 mm
- 1 1/4" cardangewricht
- 1 1/4" wringstaaf met schuifstuk
- 1 1/4" omschakelbare ratel ⊕
- 1 1/4" steekhecht
- 17 zeskant dopsleutels 3/8" ○ 6-7-8-9-10-11-12-13-14-15-16-17-18-19-20-21-22 mm
- 1 □3/8-■1/4
- 1 verloopdop, 1/2" naar 3/8" □3/8-■1/2
- 1 verlengstuk - 3/8" 125 mm
- 1 verlengstuk - 3/8" 250 mm
- 1 3/8" cardangewricht
- 1 3/8" wringstaaf met schuifstuk
- 1 3/8" omschakelbare ratel ⊕
- 21 1/2" dopsleutels, zeskant ○ 8-10-11-12-13-4-15-16-17-18-19-20-21-22-23-24-26-27-28-30-32 mm
- 2 1/2" verlengstuk met kogelkop 125-250 mm
- 1 Verloopdop 1/2" naar 3/8" □1/2-■3/8
- 1 1/2" cardangewricht
- 1 1/2" wringstaaf
- 1 1/2" omschakelbare ratel ⊕
- 3 3/8" Bougiedopsleutels ○ 16-17,8-20,8 mm
- 31 30-delig set bits met magnetische snelwissel houder in kunststof box ● ○ ⊕ ⊙ ⊚ ⊛
- 1 Waterpomp slang met Slip-proof PVC 250 mm
- 1 Zijkniptangen ✂ 160 mm
- 1 combinatietang hoogverchromd = 180 mm
- 1 Telefoon tang, lange platte gegroefde bekken = 160 mm
- 5 schroevendraaiers voor Phillips® kruiskopschroeven ● 3x75-4x100-5,5x100-6,5x150-8x150 mm
- 1 schroevendraaier voor sleufschroeven extra korte uitvoering ● 6,5x30 mm
- 3 schroevendraaiers voor Phillips® kruiskopschroeven ● PH1-PH2-PH3
- 1 schroevendraaier voor Phillips® kruiskopschroeven extra korte uitvoering ● PH2
- 4 schroevendraaiers voor Torx® schroeven ○ T20-T25-T27-T30
- 6 pendrijvers 2-3-4-5-6-8 mm
- 1 centerpunt 4 mm
- 3 koudbeitels 125-150-75 mm
- 1 ritsbeitels 125 mm
- 2 bankhamer 500-1000 g
- 1 Telescopische magneet met flexibele kop
- 1 kunststof hamer Ø 35 mm
- 1 rolbandmaat 5 m
- 1 borgveertangen, inwendig rechte punten ○ 180 mm
- 1 borgveertangen, inwendig 90° gebogen punten ○ 170 mm
- 1 borgveertangen, uitwendig rechte punten ● 175 mm
- 1 borgveertangen, uitwendig 90° gebogen punten ● 175 mm
- 1 tang met halfronde lange gladde bekken ● 140 mm
- 1 zijkniptang ✂ 125 mm
- 4 Micro-schroevendraaiers voor sleufschroeven ● 2,0-2,5-3,0-3,5 mm
- 2 Micro-schroevendraaiers voor Phillips® kruiskopschroeven ● 0-00
- 9 schroevendraaiers voor Torx® schroeven ○ T10-T15-T20-T25-T27-T30-T40-T45-T50
- 1 Verstelbare griptang 240 mm
- 1 verstelbare griptang lange bekken 175 mm
- 1 plastic slangklemtangen
- 1 plastic slangklemtangen
- 1 plastic slangklemtangen
- 1 Schuifmaat
- 1 voelmaat
- 1 Pakking schraper
- 7 Kniegewichtsleutels 6x7-8x9-10x11-12x13-14x15-16x17-18x19 mm
- 1 1/2" handgreep met kniegewricht
- 1 koevoet 450 mm
- 1 inspectiespiegel 670 mm
- 1 halfoete vijlen 200 mm
- 1 halfoete vijlen 200 mm
- 1 halfoete vijlen 200 mm
- 1 halfoete vijlen 200 mm
- 1 halfoete vijlen 200 mm
- 1 Remschoenborstel

Beta Nr.	TR
910AL	M125
920AL	M125
920FTX	M125
920PE	M125
920TX	M125
920XZN	M125
42	M25
90	M25
123Q1/4	M25
123Q3/8	M25
123Q1/2	M25
142	M25
96BPC/SC9	M105
895/1	M105
895/3	M105
895/6	M105
900	M105
900L	M105
900LP	M105
900ME	M105
900PH	M105
900TX	M105
900/16	M105
900/...	M105
900/25	M105
900/42	M105
900/55	M105
900B/30	M105
910A	M105
910/15	M105
910/16	M105
910/21	M105
910/22	M105
910/25	M105
910/42	M105
910/55	M105
920A	M105
920AN	M105
920/15	M105
920/25	M105
920/42	M105
920/55	M105
956E	M105
860MIX/A31	M166
1048N	M166
1082BM	M166
1150BM	M166
1162BM	M166
1290	M166
1290N	M166
1292	M166
1292N	M166
1297TX	M166
31	M231
32	M231
34	M231
36	M231
1370	M231
1712TF	M231
1390	M231
1692	M125
1032	M62
1034	M62
1036	M62
1038	M62
1177BM	M62
1188BM	M62
1257LP	M62
1257PH	M62
97TTX	M62
1052	M78
1058	M78
1481PL/A	M78
1481PL/B	M78
1481PL/C	M78
1650	M78
1708/20	M78
1716P	M78
80	M78
920/36A	M78
965	M78
1715	M231
1719BMA/8M	M231
1719BMA/8P	M231
1719BMA/8Q	M231
1719BMA/8R	M231
1719BMA/8T	M231
1737NX	M231

€



5988H/7M

5.760,00 059881087

Assortiment aanbevolen in combinatie met RSC24/8 - RSC24A/8 - RSC24A-XL - C37/8 - C39/8 - RSC28 - C59B - RSC50 C8 - RSC50 M8 - C55C8 - C55M8

5988L/4M

273 delig assortiment gereedschappen in EVA foam inlegbakken

► Auto herstel

Aantal/Omschrijving

- 13 1/4" dopsleutels, zeskant ○ 4-4,5-5-5,5-6-7-8-9-10-11-12-13-14 mm
- 9 1/4" Dopsleutels zeskant, lange uitvoering ○ 5-6-7-8-9-10-11-12-13 mm
- 9 Haakse stiftsleutels met kogelkop ○ 1,5-2-2,5-3-4-5-6-8-10 mm
- 1 bithouderdop
- 1 bithouderdop
- 1 bithouderdop
- 5 1/4" schroevendraaierdoppen voor inbusschroeven ○ 3-4-5-6-7 mm
- 4 Schroevendraaierdoppen voor sleufschroeven ● 0,8x4-1x5,5-1,2x6,5-2x8 mm
- 4 Schroevendraaierdoppen voor Phillips® kruiskopschroeven ⊕ PH1-PH2-PH3-PH4
- 7 Schroevendraaierdoppen voor Torx® schroeven ⊖ T10-T15-T20-T25-T27-T30-T40
- 1 Verloopstuk 1/4" naar 3/8" □ 1/4 - ■ 3/8
- 3 1/4" verlengstuk 50-100-150 mm
- 1 1/4" cardangewricht
- 1 1/4" steekhecht
- 1 1/4" wringstaaf met schuifstuk
- 1 1/4" omschakelbare ratel ⊗
- 17 zeskant dopsleutels 3/8" ○ 6-7-8-9-10-11-12-13-14-15-16-17-18-19-20-21-22 mm
- 1 □ 3/8 - ■ 1/4
- 1 verloopdop, 1/2" naar 3/8" □ 3/8 - ■ 1/2
- 1 verlengstuk - 3/8" 125 mm
- 1 verlengstuk - 3/8" 250 mm
- 1 3/8" cardangewricht
- 1 3/8" wringstaaf met schuifstuk
- 1 3/8" omschakelbare ratel ⊗
- 17 1/2" dopsleutels, zeskant ○ 8-10-11-12-13-14-15-16-17-18-19-20-21-22-23-24-26-27-28-30-32 mm
- 1 Verloopdop 1/2" naar 3/8" □ 1/2 - ■ 3/8
- 1 3/8" cardangewricht
- 2 1/2" verlengstuk met kogelkop 125 - 250 mm
- 1 1/2" wringstaaf
- 1 1/2" omschakelbare ratel ⊗
- 3 3/8" Bougiedopsleutels ○ 16-17,8-20,8 mm
- 13 Dopsleutels, zeskant, lange uitvoering ○ 8-9-10-11-12-13-14-15-16-17-19-21-22 mm
- 10 Dopsleutels voor binnenzeskant schroeven ○ 5-6-6L-7-8-8L-10-10L-12-12L mm
- 7 1/2" dopsleutels met Torx® profiel ⊖ E12-E14-E16-E18-E20-E22-E24
- 13 1/2" schroevendraaierdoppen met Torx® doppen ⊖ T20-T25-T27-T30-T30L-T40-T40L-T45-T50-T50L-T55-T60-T60L
- 8 Schroevendraaiers-doppen met XZN® profiel ○ 5-6-6L-8-8L-10-10L-12L mm
- 16 Dopsleutels, zeskant lange uitvoering ○ 10-12-13-14-15-16-17-18-19-21-22-23-24-27-30-32 mm
- 1 rolbandmaat 5 m
- 18 ringsteeksleutels 6-7-8-9-10-11-12-13-14-15-16-17-18-19-21-22-24-27 mm
- 7 ringsleutels, diepgebogen 6x7-8x9-10x11-12x13-14x15-16x17-18x19 mm
- 1 Dophouder 1/4" passend in ringratelsleutel 10 mm
- 1 Dophouder 3/8" passend in ringratelsleutel 13 mm
- 1 Dophouder 1/2" passend in ringratelsleutel 19 mm
- 12 Omschakelbare ratelringsteeksleutels 8-9-10-11-12-13-14-15-16-17-18-19 mm
- 31 30-delig set bits met magnetische snelwissel houder in kunststof box ● ○ ⊕ ⊕ ⊕ ⊕
- 1 Waterpomptang met Slip-proof PVC 250 mm
- 1 Zijkniptangen ≤ 160 mm
- 1 combinatietang hoogverchroomd = 180 mm
- 1 Telefoon tang, lange platte gegroefde bekken = 160 mm
- 5 schroevendraaiers voor Phillips® kruiskopschroeven ● 3x75-4x100-5,5x100-6,5x150-8x150 mm
- 1 schroevendraaiers voor sleufschroeven extra korte uitvoering ● 6,5x30 mm
- 3 schroevendraaiers voor Phillips® kruiskopschroeven ⊕ 4,5x80-6x100-8x150 mm
- 1 schroevendraaiers voor Phillips® kruiskopschroeven extra korte uitvoerin ⊕ 6x30 mm
- 4 schroevendraaiers voor Torx® schroeven ⊖ T20-T25-T27-T30

Beta Nr.	TR
900	M105
900L	M105
96BPC/SC9	M105
895/1	M105
895/3	M105
895/6	M105
900ME	M105
900LP	M105
900PH	M105
900TX	M105
900/16	M105
900/...	M105
900/25	M105
900BG/30	M105
900/42	M105
900/55	M105
910A	M105
910/15	M105
910/16	M105
910/21	M105
910/22	M105
910/25	M105
910/42	M105
910/55	M105
920A	M105
920/15	M105
910/25	M105
920AN	M105
920/42	M105
920/55	M105
956E	M105
910AL	M125
920PE	M125
920FTX	M125
920TX	M125
920XZN	M125
920AL	M125
1692/5	M125
42	M25
90	M25
123Q1/4	M25
123Q3/8	M25
123Q1/2	M25
142	M25
860MIX/A31	M166
1048N	M166
1082BM	M166
1150BM	M166
1162BM	M166
1290	M166
1290N	M166
1292	M166
1292N	M166
1297TX	M166



M105



M125



M25



M166

€

5988L/4M 4.110,00 059881088

Het assortiment is geschikt voor het opbergen in de artikelen RSC24 - RSC24A - RSC24A-XL - RSC24L - RSC24L/CAB - C37 - C39 - C39T - C39SM - C39MD - RSC50 - RSC55 - C59

5988U6/M

Assortiment van 214 gereedschappen in voorgevormde EVA foam inlegbakken

► Universeel gebruik

Aantal/Omschrijving

- 22 ringsteeksleutels 6-7-8-9-10-11-12-13-14-15-16-17-18-19-20-21-22-24-27-30-32-36 mm
- 11 dubbele steeksleutels 6x7-8x9-10x11-12x13-14x15-16x17
18x19-20x22-21x23-24x27-30x32 mm
- 11 ringsleutels, diepgebogen 6x7-8x9-10x11-12x13-14x15-16x17-18x19-20x22-21x23-24x27-30x32 mm
- 9 Haakse stiftsleutels met kogelkop ○ 1,5-2-2,5-3-4-5-6-8-10 mm
- 6 Schroevendraaier voor sleufschroeven ● 2,5x50-3x75-4x100-5,5x125-6,5x150-8x200 mm
- 1 Schroevendraaier voor sleufschroeven, extra-korte uitvoering ● 4x30 mm
- 4 Schroevendraaier voor Phillips® kruiskop schroeven ● PH0x60-PH1x80-PH2x100-PH3x150 mm
- 1 Schroevendraaier voor Phillips® kruiskop schroeven. Extra- korte uitvoering ● PH1x30 mm
- 12 Schroevendraaiers voor Torx® schroeven ○ T6-T7-T8-T9-T10-T15-T20-T25-T27-T30-T40-T45
- 1 spanningszoeker ●
- 3 doorslagen Ø 2-3-4 mm
- 6 pendrijvers Ø 2-3-4-5-6-8 mm
- 1 centerpunt Ø 4 mm
- 1 koudbeitels 150 mm
- 2 koudbeitels, geprofileerd model 200-250 mm
- 1 ritsbeitels 125 mm
- 1 bankhamer 500 g
- 1 kunststof hamer Ø 35 mm
- 1 rolbandmaat 3 m
- 1 Telescopische magneet met flexibele kop
- 1 Halfzoeten vijlen, vierkant met handgreep 200 mm
- 1 Halfzoeten vijlen, driehoek met handgreep 200 mm
- 1 Halfzoeten vijlen, plat met handgreep 200 mm
- 1 Halfzoeten vijlen, halfrond met handgreep 200 mm
- 1 Halfzoeten vijlen, rond met handgreep 200 mm
- 1 Remschoenborstel
- 1 afbreekmes, plat model 18 mm
- 1 borgveertangen, inwendig rechte punten ○ 180 mm
- 1 borgveertangen, inwendig 90° gebogen punten ○ 170 mm
- 1 borgveertangen, uitwendig rechte punten ● 175 mm
- 1 borgveertangen, uitwendig 90° gebogen punten ● 175 mm
- 1 Waterpomptang met Slip-proof PVC 250 mm
- 1 Verstelbare griptang 240 mm
- 1 Zijkniptangen ≲ 160 mm
- 1 Moniertangen 220 mm
- 1 blikchaar 250 mm
- 1 elektricien schaar rechte bladen
- 1 combinatietang hoogverchromd ≡ 180 mm
- 1 Telefoontang, lange halfronde gegroefde bekken ● 160 mm
- 1 Telefoontang, lange halfronde gebogen bekken ● 160 mm
- 1 bithouderdop
- 1 bithouderdop
- 1 bithouderdop
- 13 1/4" dopsleutels, zeskant ○ 4-4,5-5-5,5-6-7-8-9-10-11-12-13-14 mm
- 9 1/4" Dopsleutels zeskant, lange uitvoering ○ 5-6-7-8-9-10-11-12-13 mm
- 5 1/4" schroevendraaierdoppen voor inbusschroeven ○ 3-4-5-6-7 mm
- 4 Schroevendraaierdoppen voor sleufschroeven ● 0,8x4-1x5,5-1,2x6,5-1,2x8 mm
- 4 Schroevendraaierdoppen voor Phillips® kruiskopschroeven ● PH1-PH2-PH3-PH4
- 7 Schroevendraaierdoppen voor Torx® schroeven ○ T10-T15-T20-T25-T27-T30-T40
- 1 1/4" verlengstuk 50 mm
- 1 1/4" verlengstuk 100 mm
- 1 1/4" verlengstuk 150 mm
- 1 1/4" cardangewricht
- 1 1/4" steekhecht
- 1 1/4" wringstaaf met schuifstuk
- 1 1/4" omschakelbare ratel ⚙
- 21 1/2" dopsleutels, zeskant ○ 8-10-11-12-13-14-15-16-17
18-19-20-21-22-23-24-26-27-28-30-32 mm
- 1 Verlooptop 1/2" naar 3/8" 125 mm
- 1 1/2" cardangewricht 250 mm
- 1 1/2" verlengstuk met kogelkop
- 1 1/2" verlengstuk met kogelkop
- 1 1/2" wringstaaf
- 1 1/2" omschakelbare ratel ⚙
- 8 1/2" dopsleutels met Torx® profiel ○ 10-12-14-16-18-20-22-24 mm
- 11 Dopsleutels, zeskant lange uitvoering ○ 10-12-13-14-15-16-17-18-19-21-22 mm

Beta Nr.	TR
42	M01
55	M30
90	M30
96BPC/SC9	M30
1201E	M213
1201EN	M213
1202E	M213
1202EN	M213
1207E/TX	M213
1253	M213
30	M230
31	M230
32	M230
34	M230
35	M230
36	M230
1370	M230
1390	M230
1692	M230
1712TF	M230
1719BMA...Q	M230
1719BMA...T	M230
1719BMA...P	M230
1719BMA...M	M230
1719BMA...R	M230
1737NX	M230
1771	M230
1032	M129
1034	M129
1036	M129
1038	M129
1048N	M129
1052	M129
1082BM	M129
1098	M129
1112	M129
1128BM	M129
1150BM	M129
1166BM	M129
1168BM	M129
895/1	M100
895/3	M100
895/6	M100
900	M100
900L	M100
900ME	M100
900LP	M100
900PH	M100
900TX	M100
900/20	M100
900/21	M100
900/25	M100
900B/G/30	M100
900/42	M100
900/55	M100
920A	M100
920/15	M100
920/25	M100
920AN/125	M100
920AN/250	M100
920/42	M100
920/55	M100
920FTX	M100
920AL	M100



M01



M30

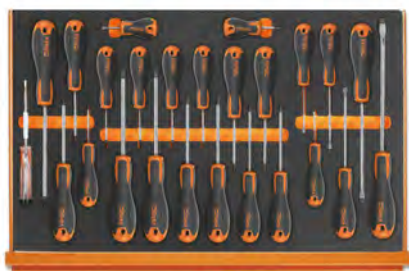

M213



M230



M129

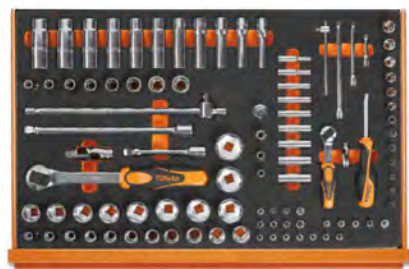

M100

€

5988U6/M 3.380,00 059881430

Assortiment aanbevolen in combinatie met RSC24 met 8 laden - RSC24/A met 8 laden - C37 met 8 laden - C39 met 8 laden
RSC24A-XL - RSC28 - C39SM - C39MO - C59B - RSC50 - RSC55

5935ET/1MB

Assortiment van 95 gereedschappen voor ladenblok C35, in voorgevormde EVA foam inlegbakken

► Elektrotechnisch onderhoud

Aantal/Omschrijving

	Beta Nr.	TR
1 Verstelbare griptang 240 mm	1052	MB65
1 bankhamer 500 g	1370	MB65
1 kunststof hamer Ø 35 mm	1390	MB65
1 Halfzoeten vijlen, vierkant met handgreep 200 mm	1719BMA...Q	MB65
1 Halfzoeten vijlen, plat met handgreep 200 mm	1719BMA...P	MB65
1 Halfzoeten vijlen, driehoek met handgreep 200 mm	1719BMA...T	MB65
1 Halfzoeten vijlen, half rond met handgreep 200 mm	1719BMA...M	MB65
1 Halfzoeten vijlen, rond met handgreep 200 mm	1719BMA...R	MB65
1 koudbeitels, geprofileerd model 200 mm	35	MB65
1 borgveertangen, inwendig rechte punten ⦿ 180 mm	1032	MB65
1 borgveertangen, inwendig 90° gebogen punten ⦿ 170 mm	1034	MB65
1 borgveertangen, uitwendig rechte punten ● 175 mm	1036	MB65
1 borgveertangen, uitwendig 90° gebogen punten ● 175 mm	1038	MB65
1 Zijkniptangen, zware uitvoering ⚡ 160 mm	1084BM	MB65
1 combinatietang hoogverchroomd ≡ 180 mm	1150BM	MB65
1 Telefoontang, lange halfronde gegroefde bekken ● 160 mm	1166BM	MB65
9 Haakse stiftsleutels met kogelkop ○	96BPCS9	MB63
1 klemschroevendraaiers voor sleufschroeven ●	1250	MB63
1 klemschroevendraaiers voor Phillips® kruiskopschroeven ⊕	1251	MB63
1 spanningszoeker ●	1253	MB63
6 Zeskant dopschroevendraaiers 1000V ○ 5,5-6-7-8-10-13 mm	943MQ	MB63
4 Schroevendraaiers voor Phillips® kruiskopschroeven, 1000V ⊕ PH0x60-PH1x80-PH2x100-PH3x150 mm	1272MQ	MB63
6 Schroevendraaiers voor sleufschroeven 1000V ● 2,5x75-3x100-4x100-5,5x125-6x150-8x175 mm	1274MQ	MB63
31 30-delig set bits met magnetische snelwissel houder in kunststof box ○ ● ⊕ ⊕ ⊕ ⊕	860MIX/A31	MB63
1 Magnetische bit houder, geïsoleerd ⊕	850MQ	MB63
8 dubbele steeksleutels 6x7-8x9-10x11-12x13-14x15 16x17-18x19-20x22 mm	55	MB64
1 Waterpomptang, doorgestoken scharnier 250 mm	1048MQ	MB64
1 zijkniptang 1000V ⚡ 140 mm	1082MQ	MB64
1 elektriciens schaar, rechte bladen met uitsparing	1128BSX	MB64
1 nożyce do cięcia kabli, w izolacji do 1000V 230 mm	1132MQ	MB64
1 Draadstriptang 1000V ⚡ 160 mm	1142MQ	MB64
1 combinatietang 1000V ≡ 180 mm	1150MQ	MB64
1 Telefoontang, lange ronde bekken, 1000V, ● 160 mm	1166MQ	MB64
1 Telefoontangen met lange halfronde gebogen bekken verchroomd ● 160 mm	1168MQ	MB64
1 Verstelbare moersleutel, 1000V 250 mm	110MQ	MB64
1 Stripmes, 1000V	1777MQ	MB64
1 Pincet, gebogen en gegroefde bekken, 1000V	993MQ	MB64
1 kabelschoentang voor geïsoleerde kabelschoenen	1602	MB64



MB65



MB64



MB63

€

5935ET/1MB

1.915,00 059351332

Assortiment aanbevolen in combinatie met C35



5980ET/A

Assortiment van 70 gereedschappen

► Elektronisch onderhoud

Aantal/Omschrijving	Beta Nr.
1 centerpunt Ø 4 mm	32
1 koudbeitels, geprofileerd model 150 mm	35
8 6x7 - 8x9 - 10x11 - 12x13 - 14x15 - 16x17 - 18x19 - 20x22 mm	55/B8N
8 8-delig set haakse stiftsleutels met zeskant profiel, lange uitvoering Ø 2÷10 mm	96LC/SC8
1 Verstelbare moersleutel 200 mm	111E
1 Magnetische bit houder, geïsoleerd	850MQ
10 10 delig set bits met magnetische bithouder in kuststof houder	860MIX/A10
1 Waterpompang, doorgestoken scharnier 250 mm	1048MQ
1 Zijkniptangen 160 mm	1082BM
1 elektriciens schaar, rechte bladen met uitsparing	1128BSX
1 kabelschaar 170 mm	1132BM
1 combinatietang hoogverchroomd 180 mm	1150BM
1 Telefoontang, lange halfronde gegroefde bekken 160 mm	1166BM
1 Telefoontang, lange halfronde gebogen bekken 160 mm	1168BM
1 klem Schroevendraaiers voor sleufschroeven 4x125 mm	1250
1 klem Schroevendraaiers v oor Phillips® kruiskop schroeven PH1x125 mm	1251
1 spanningszoeker	1253
5 Schroevendraaiër voor sleufschroeven	1201E
• 2,5x75 - 3,5x100 - 5,5x125 - 6,5x150 mm	
1 Schroevendraaiër voor sleufschroeven, extra-korte uitvoering	1201EN
• 4x30 mm	
4 Schroevendraaiër voor Phillips® kruiskop schroeven	1202E
• PH0x60 - PH1x120 - PH2x150 - PH3x150 mm	
1 Schroevendraaiër voor Phillips® kruiskop schroeven. Extra- korte uitvoering	1202EN
• PH2x30 mm	
4 Schroevendraaiers voor Phillips® kruiskop schroeven, 1000V	1272MQ
• PH0x60 - PH1x80 - PH2x100 - PH3x150 mm	
5 Schroevendraaiers voor sleufschroeven 1000V	1274MQ
• 5,5x125 - 3x100 - 4x100 - 6,5x150 - 8x175 mm	
1 Platte beitel met zijlemmet	1343
1 bankhamer 300 g	1370
1 kunststof hamer Ø 35 mm	1390
1 kabelschoentang voor geïsoleerde kabelschoenen	1602
1 25 m	BMESB1925NE
1 rolbandmaat 5 m	1692
1 Halfzoeten vijlen, half rond met handgreep 200 mm	1719BMA...M
1 Halfzoeten vijlen, rond met handgreep 200 mm	1719BMA...R
1 zaagbeugel	1725
1 klapmesmet inkeping	1777BM

€



5980ET/A 1.020,00 059801083

Assortiment aanbevolen in combinatie met C12 - 2028VV - 2032TV - 2032VV

5980ET/B

assortiment van 64 gereedschappen

► Elektronische onderhoud

Aantal/Omschrijving

- 3 pendrijvers Ø 2 - 3 - 4 mm
- 1 centerpunt Ø 4 mm
- 1 koudbeitels 150 mm
- 8 6x7 - 8x9 - 10x11 - 12x13 - 14x15 - 16x17 - 18x19 - 20x22 mm
- 9 Haakse stiftsleutels met kogelkop ○ 1,5 - 2 - 2,5 - 3 - 4 - 5 - 6 - 8 - 10 mm
- 1 ontbramer 150 mm
- 6 dopschroevendraaiers 1000V ○ 5,5 - 6 - 7 - 8 - 10 - 13 mm
- 1 Waterpomptang, doorgestoken scharnier 250 mm
- 1 zijknijptang 1000V ⚡ 160 mm
- 1 elektriciens schaar, rechte bladen met uitsparing
- 1 nozyce do ciecía kabli, w izolacji do 1000V 230 mm
- 1 Draadstriptang 1000V ⚡ 160 mm
- 1 combinatietang 1000V = 180 mm
- 1 Telefoontang, lange ronde bekken, 1000V, ● 160 mm
- 1 spanningszoeker ⚡
- 3 Schroevendraaiers voor Phillips® kruiskopschroeven, 1000V ⊕ PH0x60 - PH1x80 - PH2x100 mm
- 4 schroevendraaiers voor sleufschroeven 1000V ● 3x100 - 4x100 - 5,5x125 - 6,5x150 mm
- 1 bankhamer 300 g
- 1 kunststof hamer Ø 35 mm
- 1 kabelschoentang voor geïsoleerde kabelschoenen
- 1 flexibele lineaal 250 mm
- 1 kraspen 250 mm
- 1 rolbandmaat 5 m
- 1 waterpas, vervaardigd uit aluminium 200 mm
- 1 elektriciens beitel 10x200 mm
- 1 aftekenkoord
- 1 flexibele inspectiespiegel vierkant 600 mm
- 1 halfzoete vijlen 200 mm
- 1 halfzoete vijlen 200 mm
- 1 veertrekker
- 1 zaagbeugel
- 1 kwast
- 1 bindstriptang
- 1 kunststof oliekan met pomp 150 cc
- 100 Nylon bindstrips, zwart UV bestendig 3,6x200 mm
- 100 Nylon bindstrips, zwart UV bestendig 4,8x300 mm
- 1 afbreekmes, plat model
- 1 soldeerbout met twee standen 30 W
- 1 LED inspectielamp, vervaardigd uit stevig geanodiseerd aluminium

Beta Nr.

- 31
- 32
- 34
- 55/B8N
- 96BPC/SC9
- 345SB
- 943MQ/S6
- 1048MQ
- 1082MQ
- 1128BSX
- 1132MQ
- 1142MQ
- 1150MQ
- 1166MQ
- 1253
- 1272MQ
- 1274MQ
- 1370
- 1390
- 1602
- 1682
- 1688
- 1692
- 1696
- 1701NE3
- 1705
- 1715FL/A
- 1719BMA8/M
- 1719BMA8/R
- 1723
- 1726BM
- 1738
- 1743
- 1754
- 1748N
- 1748N
- 1771BM
- 1814M
- 1833XS/2

5980ET/B

€ 1.330,00 059801084

Assortiment aanbevolen in combinatie met C12 - 2029/VV - 2033P/VV - 2036TV

5980MQ

Assortiment van 46 gereedschappen

► Elektronisch onderhoud

Aantal/Omschrijving

- 7 Enkele steeksleutels, 1000V 10 - 12 - 13 - 14 - 17 - 19 - 22 mm
- 1 Verstelbare moersleutel, 1000V 250 mm
- 6 Zeskant dopschroevendraaiers 1000V ○ 5,5 - 6 - 7 - 8 - 10 - 13 mm
- 4 inbus T-sleutels met zeskant profiel op drie zijden ○ 4 - 5 - 6 - 8 mm
- 1 Pincet, gebogen en gegroefde bekken, 1000V
- 1 Waterpomptang, doorgestoken scharnier 250 mm
- 1 zijknijptang 1000V ⚡ 160 mm
- 1 Electricicienschaar
- 1 Draadstriptang 1000V ⚡ 160 mm
- 1 combinatietang 1000V = 180 mm
- 1 Telefoontang met lange gebogen bekken = 160 mm
- 1 Telefoontang, lange ronde bekken, 1000V, ● 160 mm
- 1 spanningszoeker ⚡
- 4 Schroevendraaiers voor Phillips® kruiskopschroeven, 1000V ⊕ PH0x60 - PH1x80 - PH2x100 - PH3x150 mm
- 5 schroevendraaiers voor sleufschroeven 1000V ● 3x100 - 4x100 - 5,5x125 - 6,5x150 - 8x175 mm
- 1 bankhamer 300 g
- 1 kunststof hamer Ø 35 mm
- 1 rolbandmaat 5 m
- 1 200 mm
- 1 Mini zaagbeugel, 1000V
- 2 Stripmes, 1000V
- 1 soldeerbout met twee standen 30 W
- 1 Ultra heldere LED zaklamp, vervaardigd uit stevig geanodiseerd aluminium, Lichtsterkte tot 500 lumen
- 1 Gecombineerde volt en continuïteit tester, 12-690V AC/DC

Beta Nr.

- 52MQ
- 110MQ
- 943MQ
- 951MQ
- 993MQ
- 1048MQ
- 1082MQ
- 1128MQ
- 1142MQ
- 1150MQ
- 1164MQ
- 1166MQ
- 1253
- 1272MQ
- 1274MQ
- 1370
- 1390
- 1692
- 1701NE/3
- 1725MQ
- 1777MQ
- 1814M
- 1833S
- 1760PT

5980MQ

€ 1.770,00 059801257

Assortiment aanbevolen in combinatie met 2029/VV

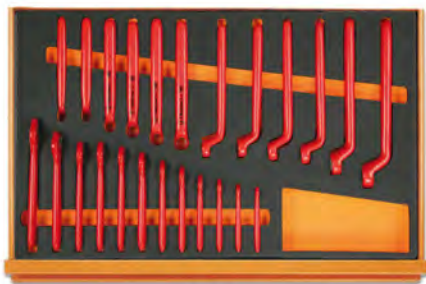

M49



M108



M161

5988 VHB-MQ

66 delig assortiment in EVA foam inlegbak

► Elektrotechnisch onderhoud

Aantal/Omschrijving

- 12 Enkele steeksleutels, 1000V 7-8-10-11-12-13-14-15-16-17-19-22 mm
- 12 Enkele ringsleutels 7-8-10-11-12-13-14-15-16-17-19-22 mm
- 4 Dopsleutels voor binnenzeskant schroeven \odot 4-5-6-8 mm
- 11 Twaalfkant dopsleutels \odot 7-8-10-11-12-13-14-15-16-17-19 mm
- 6 Dopsleutels voor Torx® schroeven, met 3/8" aandrijving \odot T15-T20-T25-T27-T30-T40
- 2 Dopsleutels voor schroeven met XZN® profiel \odot 8-10 mm
- 1 3/8" verlengstuk 125 mm
- 1 3/8" verlengstuk 250 mm
- 1 3/8" wringstaaf, T-model
- 1 3/8" omschakelbare ratel
- 1 Electricienschaar
- 1 Waterpomptang, doorgestoken scharnier 250 mm
- 1 zijknijptang 1000V \ddagger 160 mm
- 1 combinatietang 1000V \equiv 180 mm
- 1 Telefoontangen met lange platte bekken verchromd \equiv 160 mm
- 1 Telefoontang met lange gebogen bekken \equiv 160 mm
- 4 Schroevendraaiers voor Phillips® kruiskopschroeven, 1000V \oplus PH0x60 - PH1x80 - PH2x100 - PH3x150 mm
- 4 schroevendraaiers voor sleufschroeven 1000V \bullet 2,5x75 - 3x100 - 4x100 - 5,5x125 mm
- 1 Stripmes, geïsoleerd

Beta Nr.	TR
52MQ	M49
89MQ	M49
910MQ/PE	M108
910MQ/B	M108
910MQ/TX	M108
910MQ/XZN	M108
910MQ/21	M108
910MQ/22	M108
910MQ/T	M108
910MQ/55	M108
1128MQ	M161
1048MQ	M161
1082MQ	M161
1150MQ	M161
1162MQ	M161
1164MQ	M161
1272MQ	M161
1274MQ	M161
1777MQ/U	M161

€

5988 VHB-MQ 2.950,00 059880300

Het assortiment is geschikt voor het opbergen in de artikelen RSC51 - RSC23T - RSC24 - RSC24A - RSC24A-XL - RSC24L - RSC24L/CAB - RSC28 - C37 - C39 - C39SM - C39MD - C39T - RSC55 - RSC50 - C59

5980EL/A

Assortiment van 57 gereedschappen

► Elektronica

Aantal/Omschrijving

- 13 4÷14 mm
- 9 haakse inbussleutels \odot 1,5+10 mm
- 1 pincet met gebogen smalle gegroefde bekken 130 mm
- 1 pincet met rechte smalle gegroefde bekken 150 mm
- 1 pincet met zelfklemmende rechte gegroefde spatel bekken 155 mm
- 1 elektricienschaar, rechte bladen
- 1 draadstriptang \ddagger 160 mm
- 1 Telefoontang, lange halfronde gegroefde bekken \bullet 160 mm
- 1 tang met lange platte bekken \equiv
- 1 tang met halfronde lange gebogen bekken \bullet
- 1 combinatietang \bullet
- 1 elektronica kopknijptang \ddagger
- 1 zijknijptang \ddagger
- 1 klemschroevendraaiers voor sleufschroeven \bullet 4x125 mm
- 1 klemschroevendraaiers voor Phillips® kruiskopschroeven \oplus PH0x125 mm
- 8 microschoevendraaiers
- 1 bankhamer 200 g
- 1 rolbandmaat 5 m
- 1 inspectiespiegel
- 3 Naaldvijlen
- 1 veertrekker
- 1 kwast
- 1 oliespuit penmodel
- 1 afbrekmes, plat model
- 1 Zelfklemmende ronde en gekartelde schaar vervaardigd uit roestvast staal
- 1 soldeerbout met twee standen 25 W
- 1 tinzuiger
- 1 LED inspectielamp, vervaardigd uit stevig geanodiseerd aluminium

Beta Nr.	TR
73/B13N	
96N/SC9	
991	
992	
998	
1128BMX	
1142BM	
1166BM	
1172BM	
1178BM/P	
1178BM	
1185BM	
1188BM	
1250	
1251	
1257LPH/S8	
1370	
1692	
1715	
1720/S3	
1723	
1738	
1756	
1771	
1002	
1814M	
1830T	
1833XS/2	

€

5980EL/A 1.016,00 059801081

Assortiment aanbevolen in combinatie met 2032TV - 2028/VV - 2033P/VV

5980EL/B

Assortiment van 98 gereedschappen

► Elektronica

Aantal/Omschrijving	Beta Nr.
13 4÷14 mm	73/B13N
9 haakse inbussleutels \odot 1,5÷10 mm	96/SC9
8 haakse stiftsleutels met Torx® profiel \odot T9 - T10 - T15 - T20 - T25 - T27 - T30 - T40	97TX/BG8
1 Verstelbare moersleutel 150 mm	111E
18 13 - del set zeskant dopsleutel en toebehoren, 1/4" aansluiting	900/C13-5
1 pincet met rechte smalle gegroefde bekken 130 mm	990
1 pincet met gebogen smalle gegroefde bekken 130 mm	991
1 pincet ket korte puntige bekken 120 mm	999A
1 elektricienschaar, rechte bladen	1128BMX
1 draadstriptang, zelfinstellend 170 mm	1149F
1 combinatietang hoogverchroomd \equiv 180 mm	1150BM
1 tang met lange platte bekken \equiv 140 mm	1172BM
1 tang met halfronde lange gladde bekken \bullet 140 mm	1177BM
1 tang met halfronde lange gebogen bekken \bullet 140 mm	1178BM/P
1 zijknijptang met afgeronde bekken en vlakke snijvorm ζ 120 mm	1184BM
1 zijknijptang met puntige bekken en vlakke snijvorm ζ 120 mm	1186BM
1 kopknijptang met vlakke snijvorm ζ	1191BM
8 microschroevendraaiers	1257LPH/S8
1 spanningszoeker \bullet	1253
1 schroevendraaier voor sleufschroeven extra korte uitvoering \bullet 6,5x30 mm	1290N
3 schroevendraaiers voor Phillips® kruiskopschroeven \oplus PH0x60 - PH1x80 - PH2x100 mm	1292
2 schroevendraaier voor Phillips® kruiskopschroeven extra korte uitvoering \oplus PH1x30 - PH2x30 mm	1292N
5 schroevendraaiers voor verzonken sleufschroeven \bullet 2,5x60 - 3x75 - 4x100 - 5x125 - 6,5x150 mm	1294
1 bankhamer 200 g	1370
1 flexibele lineaal 150 mm	1682
1 kraspen 220 mm	1688
1 rolbandmaat 5 m	1692
1 inspectiespiegel 670 mm	1715
1 Naaldvijlen \bullet	1720R
1 Naaldvijlen \blacktriangle	1720T
1 Naaldvijlen \blacksquare	1720P
1 veertrekker	1723
1 kwast	1738
1 oliespuit penmodel	1756
1 afbreekmes, plat model	1771BM
1 klappesmet inkeping	1777BM
1 Zelfklemmende ronde en gekartelde schaar vervaardigd uit roestvast staal	1002
1 soldeerbout met twee standen 25W	1814M
1 tinsuiger	1830T
1 LED inspectielamp, vervaardigd uit stevig geanodiseerd aluminium	1833XS/2



5980EL/B

€ 1.430,00 059801082

Assortiment aanbevolen in combinatie met 2029/VV - 2033P/VV - 2036TV



5980ID/1

assortiment van 24 gereedschappen

► Onderhoud van loodgieterswerk

Aantal/Omschrijving

Beta Nr.

1	Verstelbare moersleutel 250 mm	111E
1	Ø 3+28 mm	332/2
1	pijpsnijder voor koperen en licht metalen pijp Ø 3+30 mm	334
1	Ø 0+42 mm	342
1	140 mm	345SB2
2	320-410 mm	376
2	Waterpomptang met Slip-proof PVC 175-250 mm	1048N
1	elektricienschaar, rechte bladen	1128BMX
1	Zware combinatietangen, twee componenten handgreep, industriële afwerking \equiv 180 mm	1150GBM
4	Schroevendraaier voor sleufschroeven ● 3x75-4x100-5,5x150-8x150 mm	1201E
2	Schroevendraaier voor Phillips® kruiskop schroeven	1202E
	● PH1x80-PH2x100	
1	bankhamer 500 g	1370
1	rolbandmaat, kunststof 2 m	1690F
1	rolbandmaat 5 m	1692/5
1	waterpas, vervaardigd uit aluminium 200 mm	1696
1	Halfzoeten vijlen, half rond met handgreep 200 mm	1719BMA...M
1	platte rasp 200 mm	1719BM/RL
1	zaagbeugel	1725

€



5980ID/1

623,00 059801086

Beta

5989 VEM

assortiment van 81 reparatie- en onderhoudsgereedschappen voor hybride en elektrische voertuigen

► Auto reparatie

Aantal/Omschrijving

- 1 Isolatie mat
- 4 Kunststof afzetpalen met vulbare voeten
- 1 Multimeter/Ohmmeter voor hoog voltage isolatie testen.TRUE RMS indicator
- 1 Gecombineerde volt en continuïteit tester,12-690V AC/DC
- 1 Reserve steekpennen voor digitale multimeters en ampereklemmen
- 1 Composiet isolerende handschoenen Gr. 10
- 1 Pneumatisch apparaat voor het testen van geïsoleerde handschoenen
- 1 Kunststof afzet ketting
- 2 Aluminium waarschuwingstekens A1, A2
- 2 waarschuwingstekens D2, D3
- 12 Enkele steeksleutels, 1000V 7-8-10-11-12-13-14-15-16-17-19-22 mm
- 12 Enkele ringsleutels 7-8-10-11-12-13-14-15-16-17-19-22 mm
- 4 Dopsleutels voor binnenzeskant schroeven \odot 4-5-6-8 mm
- 11 Twaalfkant dopsleutels \odot 7-8-10-11-12-13-14-15-16-17-19 mm
- 6 Dopsleutels voor Torx® schroeven, met 3/8" aandrijving \odot TX15-TX20-TX25-TX27-TX30-TX40
- 2 Dopsleutels voor schroeven met XZN® profiel \odot M8-M10
- 1 3/8" verlengstuk 140 mm
- 1 3/8" verlengstuk 265 mm
- 1 3/8" wringstaaf, T-model 200 mm
- 1 3/8" omschakelbare ratel 203 mm
- 1 Waterpomptang, doorgestoken scharnier 250 mm
- 1 zijknijptang 1000V \leq 160 mm
- 1 Electricienschuur 145 mm
- 1 combinatietang 1000V \equiv 180 mm
- 1 Telefoontangen met lange platte bekken verchroomd \equiv 160 mm
- 1 Telefoontang met lange gebogen bekken \equiv 160 mm
- 4 Schroevendraaiers voor Phillips® kruiskopschroeven, 1000V \oplus PH0-PH1-PH2-PH3
- 4 schroevendraaiers voor sleufschroeven 1000V \bullet 2,5x75-3x100-4x100-5.5x125 mm
- 1 Stripmes, geïsoleerd 190 mm

Beta Nr.	TR
1995MQ/T	
7104 90	
1760/OHM	
1760PT	
1760DGT-R3	
1996MQ/GM	
1996VPG	
7105 6	
7109A	
7109D	
52MQ	M49
89MQ	M49
910MQ/PE	M108
910MQ/B	M108
910MQ/TX	M108
910MQ/XZN	M108
910MQ/21	M108
910MQ/22	M108
910MQ/T	M108
910MQ/55	M108
1048MQ	M161
1082MQ	M161
1128MQ	M161
1150MQ	M161
1162MQ	M161
1164MQ	M161
1272MQ	M161
1274MQ	M161
1777MQ/U	M161



M49



M108



M161



5989 VEM

€ 5.120,00 059890116

Assortiment aanbevolen in combinatie met RSC24/6-R

5902MT

106-delig assortiment gereedschappen voor agrarische, bouw en grondverzetmachines

► Grondverzet

Aantal/Omschrijving



Aantal/Omschrijving	Beta Nr.
2 doorslagen Ø 3 - 4 mm	30
2 pendrijvers Ø 6 - 8 mm	31
1 centerpunt Ø 4 mm	32
2 koudbeitels, geprofileerd model 150 - 200 mm	35
18 ringsteeksleutels 6+14 - 17 - 19 - 22 - 24 - 27 - 30 - 32 - 36 - 41 mm	42
10 ringsleutels, diepgebogen 6x7 - 8x9 - 10x11 - 12x13 - 14x15 - 16x17 - 18x19 - 20x22 - 24x27 - 30x32 mm	90
10 haakse inbussleutels ○ 1,5+12 mm	96N/B10
17 1/2" dopsleutels, zeskant ○ 10+22 - 24 - 27 - 30 - 32 mm	920A
1 1/2" verlengstuk 125 mm	920/21
1 1/2" verlengstuk 255 mm	920/22
1 1/2" cardangewricht	920/25
1 1/2" wringstaaf	920/42
1 1/2" ratel met doorsteekvierkant ⊕	920/50
11 3/4" dopsleutels, zeskant ○ 22 - 24 - 27 - 30 - 32 - 36 - 41 - 46 - 50 - 55 - 60 mm	928A
1 3/4" verlengstuk 200 mm	928/21
1 3/4" handgreep met kniegewricht	928/36A
1 3/4" wringstaaf	928/42
1 3/4" omschakelbare ratel ⊕	928/55
1 koevoet	964
1 Waterpomptang met Slip-proof PVC 250 mm	1048N
1 verstelbare griptang geprofileerde bek	1055
1 Zijknijptangen, twee componenten handgreep, industriële afwerking ≡ 160 mm	1084GBM
1 elektricienschaar, rechte bladen	1128BMX
1 Zware combinatietangen, twee componenten handgreep, industriële afwerking ≡ 180 mm	1150GBM
1 Telefoontangen, extra lange halfronde gegroefde bekken, twee componenten handgreep, industriële afwerking ● 160 mm	1166GBM
4 schroevendraaiers voor sleufschroeven met zeskant ● 6,5x150 - 8x175 - 10x200 - 12x250 mm	1260E
3 schroevendraaiers voor Phillips® kruiskopschroeven met zeskant ⊕ PH2x150 - PH3x175 - PH4x200 mm	1262E
1 bolbankhamer 900 g	1377
1 kunststof hamer Ø 35 mm	1390
1 voelmaat	1708/20
1 schraapstaaf, driekantig model 200 mm	1717B
5 5-delig set halfzoeten vijlen met handgreep 200 mm	1719BMA...S5
1 zaagbeugel	1725

€

5902MT

2.370,00 059021053

Assortiment aanbevolen in combinatie met RSC22 - RSC23 - RSC23C - C39T

5902MT/AS

99-delig assortiment gereedschappen voor grondverzetmachines (CARTERPILLAR)

► Grondverzet

Aantal/Omschrijving	Beta Nr.
2 doorslagen Ø 3 - 4 mm	30
2 pendrijvers Ø 6 - 8 mm	31
1 centerpunt Ø 4 mm	32
2 koudbeitels, geprofileerd model 150 - 200 mm	35
20 ringsteeksleutels 1/4+1.1/2"	42AS
6 ringsleutels, diepgebogen 1/4x5/16 - 3/8x7/16 - 1/2x9/16 5/8x3/4 - 11/16x13/16 - 7/8x15/16"	90AS
11 haakse inbussleutels \odot 3/64+3/8"	96AS/B11
10 1/2" dopsleutels, twaalfkant \odot 7/16 - 1/2 - 9/16 5/8 - 11/16 - 3/4 - 13/16 - 7/8 - 15/16 - 1"	920AS
1 1/2" verlengstuk 125 mm	920/21
1 1/2" verlengstuk 255 mm	920/22
1 1/2" cardangewricht	920/25
1 1/2" wringstaaf	920/42
1 1/2" ratel met doorsteekvierkant \oplus	920/50
12 Zeskant dopsleutels 1/4" \square 3/4", 7/8 - 15/16 - 1 - 1.1/16 - 1.1/8 - 1.1/4 - 1.5/16 1.1/2 - 1.5/8 - 1.11/16 - 1.7/8 - 2"	928AS
1 3/4" verlengstuk 200 mm	928/21
1 3/4" handgreep met kniegewricht	928/36A
1 3/4" wringstaaf	928/42
1 3/4" omschakelbare ratel \oplus	928/55
1 koevoet	964
1 Waterpomptang met Slip-proof PVC 250 mm	1048N
1 verstelbare griptang geprofileerde bek	1055
1 Zijkniptangen, twee componenten handgreep, industriële afwerking \square 160 mm	1084GBM
1 elektricienschaar, rechte bladen	1128BMX
1 Zware combinatietangen, twee componenten handgreep, industriële afwerking \square 180 mm	1150GBM
1 Telefoon tangen, extra lange halfronde gegroefde bekken, twee componenten handgreep, industriële afwerking \bullet 160 mm	1166GBM
4 schroevendraaiers voor sleufschroeven met zeskant \bullet 6,5x150 - 8x175 - 10x200 - 12x250 mm	1260E
3 schroevendraaiers voor Phillips® kruiskopschroeven met zeskant \oplus PH2x150 - PH3x175 - PH4x200 mm	1262E
1 bolbankhamer 900 g	1377
1 kunststof hamer Ø 35 mm	1390
1 voelmaat 150 - 200 mm	1708/20
1 schraapstaal, driekantig model 200 mm	1717B
5 5-delig set halfzoeten vijlen met handgreep 200 mm	1719BMA...S5
1 zaagbeugel	1725



€



5902MT/AS

2.465,00 059021054

Assortiment aanbevolen in combinatie met RSC22 - RSC23 - RSC23C - C39T

5904VG/2M

Assortiment van 170 gereedschappen in voorgevormde EVA foam inlegbakken

► Auto herstel

Aantal/Omschrijving

- 16 ringsteeksleutels 6+21 mm
- 5 ringsteeksleutels 22 - 24 - 27 - 30 - 32 mm
- 8 haakse stiftsleutels met kracht handgreep \odot 2-2,5-3-4-5-6-7-8 mm
- 5 schroevendraaiers voor Torx® schroeven \odot T10-T15-T20-T25-T30
- 7 bits voor inbusschroeven \odot 4-5-6-7-8-10-12 mm
- 7 bits voor inbusschroeven \odot 4-5-6-7-8-10-12 mm
- 5 bits voor XZN® schroeven \odot 5-6-8-10-12 mm
- 5 bits voor XZN® schroeven \odot 5-6-8-10-12 mm
- 7 bits voor Torx® schroeven \odot T20-T25-T30-T40-T45-T50-T55
- 6 bits voor Torx® schroeven \odot T25-T30-T40-T45-T50-T55
- 7 bits voor Tamper Resistant Torx® schroeven \odot T20-T25-T30-T40-T45-T50-T55
- 1 bithouderdop voor bits 867
- 1 bithouderdop voor bits 867
- 5 Schroevendraaiers voor sleufschroeven \bullet 3x75 - 3,5x100 - 4x125 - 5,5x150 - 6,5x150 mm
- 3 Schroevendraaiers voor Phillips® kruiskop schroeven \oplus PH0x60 - PH1x80 - PH2x100 mm
- 1 schroevendraaier voor sleufschroeven extra korte uitvoering \bullet 4x30 mm
- 1 schroevendraaiers voor Phillips® kruiskopschroeven extra korte uitvoering \oplus PH1x30 mm
- 1 Bit voor sleufschroeven, met kleur indicatie \bullet 0,5x3 - 0,6x4,5 - 0,8x5,5 - 1x5,5 - 1,2x6,5 mm
- 8 Bits voor binnenzeskant schroeven, met kleur indicatie \odot 2 - 2,5 - 3 - 4 - 5 - 6 - 8 - 10 mm
- 5 Bits voor kruiskopschroeven met Phillips® profiel, met kleur indicatie \oplus PH0 - PH1 - PH2 - PH3 - PH4
- 4 Bits voor kruiskopschroeven met Pozidriv® - Supadriv® profiel, met kleur indicatie \oplus PZ1 - PZ2 - PZ3 - PZ4
- 11 Bits voor schroeven met Torx® profiel, met kleur indicatie \odot T6-T7-T8-T9-T10-T15-T20-T25-T27-T30-T40
- 8 Bits voor schroeven met Tamper Resistant Torx® profiel, met kleur indicatie \odot T9-T10-T15-T20-T25-T27-T30-T40
- 1 Magnetische bithouder met handgreep 230 mm
- 1 Omschakelbare ratel voor bits 100 mm
- 1 Magnetische bithouder, lang 80 mm
- 1 Dophouders \blacksquare 1/4 - \square 1/4
- 2 koudbeitels, geprofileerd model 100 - 200 mm
- 1 bankhamer 300 g
- 1 kunststof hamer \varnothing 35 mm
- 1 1/2" verlengstuk met kogelkop 125 mm
- 1 1/2" verlengstuk met kogelkop 250 mm
- 1 1/2" cardangewricht
- 1 1/2" wringstaaf
- 1 1/2" omschakelbare ratel \oplus
- 19 1/2" dopsleutels, zeskant \odot 10+24 - 26 - 27 - 30 - 32 mm
- 1 combinatietang hoogverchroomd \equiv 180 mm
- 1 Telefoontang, lange halfronde gegroefde bekken \bullet 160 mm
- 1 Zijkniptangen, zware uitvoering ζ 160 mm
- 1 borgveertangen, inwendig rechte punten \odot 180 mm
- 1 borgveertangen, inwendig 90° gebogen punten \odot 170 mm
- 1 borgveertangen, uitwendig rechte punten \bullet 175 mm
- 1 borgveertangen, uitwendig 90° gebogen punten \bullet 175 mm

Beta Nr.	TR
	42
	42
	96T
	97TTX
	867PE
	867PE/L
	867XZN
	867XZNL
	867TX
	867TXL
	867RTX
	867/1
	867/2
	1260
	1262
	1260N
	1262N
	860LP
	860PE
	860PH
	860PZ
	860TX
	860RTX
	851SR
	860/55
	882P
	8920
	35
	1370
	1390
	920AN/125
	920AN/250
	920/25
	920/42
	920/55
	920A
	1150BM
	1166BM
	1084BM
	1032
	1034
	1036
	1038



M05 M06 VPM3



M50 M55 M86



M208 M85 M234



M83 M136 M145

€

5904VG/2M

1.875,00 059041198

Assortiment aanbevolen in combinatie met RSC24 - RSC24A - RSC24A-XL - C37 - C39
RSC24L - RSC24L/CAB - C59 - C39T - C39SM - C39MD - RSC23T - RSC28 - RSC50 - RSC55

5904VG/2T

Assortiment van 99 gereedschappen in voorg gevormde ABS inlegbakken

► Auto herstel

Aantal/Omschrijving

- 16 ringsteeksleutels 6÷21 mm
- 5 ringsteeksleutels 22 - 24 - 27 - 30 - 32 mm
- 19 1/2" dopsleutels, zeskant \odot 10÷24 - 26 - 27 - 30 - 32 mm
- 5 1/2" schroevendraaiers voor inbusschroeven \odot 5 - 6 - 8 - 10 - 12 mm
- 1 1/2" verlengstuk 125 mm
- 1 1/2" verlengstuk 255 mm
- 1 1/2" cardangewricht
- 1 1/2" wringstaaf
- 1 1/2" omschakelbare ratel \odot
- 1 Waterpomptang met Slip-proof PVC 250 mm
- 1 Verstelbare griptang 240 mm
- 1 Zijkniptangen, zware uitvoering ∇ 160 mm
- 1 Telefontang, lange platte gegroefde bekken \bullet 160 mm
- 1 Combinatietangen \equiv 180 mm
- 1 borgveertangen, inwendig rechte punten \odot 180 mm
- 1 borgveertangen, uitwendig rechte punten \bullet 175 mm
- 1 borgveertangen, inwendig 90° gebogen punten \odot 170 mm
- 1 borgveertangen, uitwendig 90° gebogen punten \bullet 175 mm
- 2 koudbeitels, geprofileerd model 100 - 200 mm
- 1 bankhamer 300 g
- 1 kunststof hamer \varnothing 35 mm
- 4 Schroevendraaiers voor sleufschroeven \bullet 3x75 - 4x100 - 5,5x150 - 6,5x150 mm
- 3 Schroevendraaiers voor Phillips® kruiskop schroeven \oplus PH0x60 - PH1x80 - PH2x100 mm
- 8 dubbele steeksleutels 6x7 - 8x9 - 10x11 - 12x13 - 14x15 - 16x17 - 18x19 - 20x22 mm
- 9 haakse inbussleutels \odot 1,5 - 2 - 2,5 - 3 - 4 - 5 - 6 - 8 - 10 mm
- 6 haakse steeksleutels met kracht handgreep \odot 2 - 2,5 - 3 - 4 - 5 - 6 mm
- 6 schroevendraaiers voor Torx® schroeven \odot T10 - T15 - T20 - T25 - T27 - T30



T05 T06 T80



T153 T138 T145 T234



T208 T33 T52 T55

Beta Nr.	TR
42	T05
42	T06
920A	T80
920ME	T80
92021	T80
92022	T80
92025	T80
92042	T80
92055	T80
1048N	T153
1052	T153
1084	T138
1166	T138
1150	T138
1032	T145
1036	T145
1034	T145
1038	T145
35	T234
1370	T234
1390	T234
1260	T208
1262	T208
55	T33
96/SC9	T33
96T	T52
97TTX	T55

€

5904VG/2T 1.555,00 059041191

Assortiment aanbevolen in combinatie met RSC51 - RSC24 - RSC24A - RSC24A-XL - C37 - C39
RSC23T - C39T - RSC24L - RSC24L/CAB - C59 - RSC28 - C39SM - C39MD - RSC50 - RSC55

5904VG/3

132-delig assortiment gereedschappen

► Automobiel onderhoud

Aantal/Omschrijving	Beta Nr.
6 Ø 2+8 mm	31/B6N
1 centerpunt Ø 5 mm	32
1 koudbeitels, geprofileerd model 200 mm	35
17 ringsteeksleutels 6+22 mm	42
8 dubbele steeksleutels 6x7 - 8x9 - 10x11 - 12x13 - 14x15 - 16x17 - 18x19 - 20x22 mm	55
9 haakse inbussleutels Ø 1,5 - 2 - 2,5 - 3 - 4 - 5 - 6 - 8 - 10 mm	96N/SC9
11 haakse stiftsleutels met kracht handgreep Ø 2+10 mm	96T/SP11
13 haakse stiftsleutels met Torx® profiel ⚡ T6+T50	97TX/B13
1 Verstelbare moersleutel 300 mm	111E
13 1/2" zeskant dopsleutels op dophouder Ø 10+22 mm	920A/SB13
1 1/2" verlengstuk 125 mm	920/21
1 1/2" verlengstuk 255 mm	920/22
1 1/2" cardangewricht	920/25
1 1/2" wringstaaf	920/42
1 1/2" ratel met doorsteekvierkant ⚡	920/50
6 T - sleutels met cardangewricht en zeskantdop Ø 8 - 10 - 12 - 13 - 17 - 19 mm	952
1 koevoet 450 mm	965
2 borgveertangen, inwendig rechte punten Ø 180 - 225 mm	1032
2 borgveertangen, inwendig 90° gebogen punten Ø 170 - 210 mm	1034
2 borgveertangen, uitwendig rechte punten ● 175 - 225 mm	1036
2 borgveertangen, uitwendig 90° gebogen punten ● 175 - 220 mm	1038
1 Waterpomptang met Slip-proof PVC 250 mm	1048N
1 Verstelbare griptang 240 mm	1057A
1 Zijknijptangen, twee componenten handgreep, industriële afwerking ⚡ 200 mm	1084GBM
1 hefboom kopknijptang ⚡ 200 mm	1092V
1 blichschaar 250 mm	1112
1 elektricienschaar, rechte bladen	1128BMX
1 Zware combinatietangen, twee componenten handgreep, industriële afwerking ⚡ 180 mm	1150GBM
4 Schroevendraaiers voor sleufschroeven ● 3x75 - 4x100 - 5,5x125 - 6,5x150 mm	1260
1 schroevendraaier voor sleufschroeven extra korte uitvoering ● 6,5x30 mm	1260N
2 schroevendraaiers voor sleufschroeven met zeskant ● 8x175 - 10x200 mm	1260E
3 Schroevendraaiers voor Phillips® kruiskop schroeven ⚡ PH0x100 - PH1x120 - PH2x100 mm	1262
1 schroevendraaiers voor Phillips® kruiskopschroeven extra korte uitvoering ⚡ PH2x30 mm	1262N
1 schroevendraaiers voor Phillips® kruiskopschroeven met zeskant ⚡ PH3x175mm	1262E
1 schroevendraaier voor Phillips® kruiskopschroeven lange uitvoering ⚡ PH2x400 mm	1262L
1 schroevendraaier voor verzonken sleufschroeven lange uitvoering ● 6,5x400 mm	1264L
1 bankhamer 500 g	1370
1 kunststof hamer Ø 45 mm	1390
1 oliefiltersleutel, verstelbaar	1491
1 voelmaat	1708/20
5 5-delig set halfoeten vijlen met handgreep 200 mm	1719BMA...S5
1 zaagbeugel	1726BM
1 metalen oliekan met pomp, 200 cc	1751N



€ 

5904VG/3 2.510,00 059041062

Assortiment aanbevolen in combinatie met RSC24 - RSC24A - RSC24A-XL - C37 - C39 met 7 - 8 laden
RSC24L - RSC24L/CAB - C59 - RSC50 - RSC55

5904VG/3T

Assortiment van 102 gereedschappen in voorgevormde ABS inlegbakken



T199 T202 T83

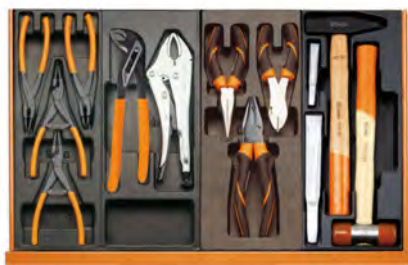

T145 T153 T137 T234



T52 T33 T05 T06



T63 VP5

► Auto herstel

Aantal/Omschrijving

- 21 ringsteeksleutels 6-7-8-9-10-11-12-13-14-15-16-17
18-19-20-21-22-24-27-30-32 mm
- 8 dubbele steeksleutels 6x7-8x9-10x11-12x13-14x15
16x17-18x19-20x22 mm
- 9 haakse inbussleutels \odot 1,5+10 mm
- 6 haakse stiftsleutels met kracht handgreep \odot 2-2,5-3-4-5-6 mm
- 8 T - sleutels met cardangewricht en zeskantop \odot 7-8-10-12-13-14-17-19 mm
- 19 1/2" dopsleutels, zeskant \odot 10-11-12-13-14-15-16-17-18-19
20-21-22-23-24-26-27-30-32 mm
- 1 1/2" verlengstuk 125 mm
- 1 1/2" verlengstuk 255 mm
- 1 1/2" cardangewricht
- 1 1/2" wringstaaf 305 mm
- 1 1/2" omschakelbare ratel \otimes
- 1 Zijkniptangen, zware uitvoering \ddagger 160 mm
- 1 combinatietang hoogverchroomd \equiv 180 mm
- 1 Telefoontang, lange halfronde gegroefde bekken \bullet 160 mm
- 1 borgveertangen, inwendig rechte punten \odot 180 mm
- 1 borgveertangen, inwendig 90° gebogen punten \odot 170 mm
- 1 borgveertangen, uitwendig rechte punten \bullet 175 mm
- 1 borgveertangen, uitwendig 90° gebogen punten \bullet 175 mm
- 1 Verstelbare griptang 240 mm
- 1 Waterpomptang met Slip-proof PVC 250 mm
- 7 Schroevendraaiers voor sleufschroeven \bullet 2,5x50 - 3x75 - 3,5x100 - 4x125 - 5,5x100 - 5,5x150
- 6,5x150 mm
- 6 Schroevendraaiers voor Phillips® kruiskop schroeven \oplus PH0x60 - PH0x100 - PH1x80
PH1x120 - PH2x100 - PH2x150 mm
- 2 koudbeitels, geprofileerd model 100-200 mm
- 1 bankhamer 300 g
- 1 kunststof hamer \varnothing 35 mm
- 1 kunststof inleg

Beta Nr.	TR
42	T05-T06
55	T33
96/SC9	T33
96T	T52
952	T63
920A	T83
920/21	T83
920/22	T83
920/25	T83
920/42	T83
920/55	T83
1084BM	T137
1150BM	T137
1166BM	T137
1032	T145
1034	T145
1036	T145
1038	T145
1052	T153
1048N	T153
1260	T199
1262	T202
35	T234
1370	T234
1390	T234
VP5	

€

5904VG/3T 1.840,00 059041510

Assortiment aanbevolen in combinatie met C24S - C24SA - C37 - C39
C24SL - C24SL/CAB - C59 - RSC50 - RSC55 - C23ST - C39T - C28 - C39SM - C39MD

5904VG/5T

Assortiment van 153 gereedschappen in voorgevormde ABS inlegbakken

► Auto herstel

Aantal/Omschrijving

- 5 1/2" schroevendraaiers voor inbusschroeven \odot 5 - 6 - 8 - 10 - 12 mm
- 1 1/2" verlengstuk 125 mm
- 1 1/2" verlengstuk 255 mm
- 1 1/2" cardangewricht
- 1 1/2" wringstaaf
- 1 1/2" omschakelbare ratel \otimes
- 19 1/2" dopsleutels, zeskant \odot 10+24 - 26 - 27 - 30 - 32 mm
- 16 ringsteeksleutels 6+21 mm
- 5 ringsteeksleutels 22 - 24 - 27 - 30 - 32 mm
- 8 T - sleutels met cardangewricht en zeskantdop \odot 7 - 8 - 10 - 12 - 13 - 14 - 17 - 19 mm
- 1 kunststof inleg
- 1 borgveertangen, inwendig rechte punten \odot 180 mm
- 1 borgveertangen, inwendig 90° gebogen punten \odot 170 mm
- 1 borgveertangen, uitwendig rechte punten \bullet 175 mm
- 1 borgveertangen, uitwendig 90° gebogen punten \bullet 175 mm
- 7 schroevendraaiers voor Phillips® kruiskopschroeven \bullet 2,5x50 - 3x75 - 3,5x100 - 4x125 - 5,5x100 - 5,5x150 - 6,5x150 mm
- 5 schroevendraaiers voor Torx® schroeven \odot T25 - T27 - T30 - T40 - T45
- 6 haakse stiftsleutels met kracht handgreep \odot 2 - 2,5 - 3 - 4 - 5 - 6 mm
- 8 dubbele steeksleutels 6x7 - 8x9 - 10x11 - 12x13 - 14x15 - 16x17 - 18x19 - 20x22 mm
- 9 haakse inbussleutels \odot 1,5 - 2 - 2,5 - 3 - 4 - 5 - 6 - 8 - 10 mm
- 3 schroevendraaiers voor Phillips® kruiskopschroeven \bullet 8x150 - 8x200 - 10x200 mm
- 2 schroevendraaiers voor sleufschroeven extra korte uitvoering \bullet 4x30 - 6,5x30 mm
- 6 schroevendraaiers voor Phillips® kruiskopschroeven \oplus PH0x60 - PH0x100 - PH1x80 - PH1x120 - PH2x100 - PH2x150 mm
- 2 schroevendraaiers voor Phillips® kruiskopschroeven \oplus PH3x150 - PH4x200 mm
- 2 schroevendraaiers voor Phillips® kruiskopschroeven extra korte uitvoering \oplus PH1x30 - PH2x30 mm
- 2 koudbeitels, geprofileerd model 100 - 200 mm
- 1 bankhamer 300 g
- 1 kunststof hamer \varnothing 35 mm
- 1 combinatietang hoogverchromd \equiv 180 mm
- 1 Telefoontang, lange halfronde gegroefde bekken \bullet 160 mm
- 1 Zijkniptangen, zware uitvoering \angle 160 mm
- 6 bits voor Torx® schroeven \odot T6+T15
- 8 bits voor Torx® schroeven \odot T20+T55
- 1 bithouderdop
- 1 bithouderdop
- 6 1/4" dopsleutels voor Torx® schroeven \odot E4+E10
- 7 1/2" dopsleutels met Torx® profiel \odot E12+E24
- 3 1/2" schroevendraaiers met Torx® doppen \odot T55L - T60 - T70L
- 1 Waterpomptang met Slip-proof PVC 250 mm
- 1 Verstelbare griptang 240 mm

Beta Nr.	TR
920ME	T80
920/21	T80
920/22	T80
920/25	T80
920/42	T80
920/55	T80
920A	T80
42	T05
42	T06
952	T63
VP6	VP6
1032	T145
1034	T145
1036	T145
1038	T145
1290	T170
1297TX	T176
96T	T52
55	T33
96N/SC9	T33
1290	T171
1290N	T171
1292	T172
1292	T173
1292N	T173
35	T234
1370	T234
1390	T234
1150BM	T137
1166BM	T137
1084BM	T137
861TX	T112
866TX	T112
895/1	T112
895/6	T112
900FTX	T112
920FTX	T112
920TX	T112
1048N	T153
1052	T153



T80 T05 T06



T63 VP6



T145 T170 T176 T52



T33 T171 T172 T173



T234 T137 T112 T153

€

5904VG/5T 2.580,00 059041196

Assortiment aanbevolen in combinatie met RSC24 met 7 - 8 laden - RSC24A met 7 - 8 laden - RSC24A-XL - C37 met 7 - 8 laden - C39 met 7 - 8 laden - RSC24L - RSC24L/CAB - C59 - RSC23T - RSC28 - C39MD - C39SM - RSC50 - RSC55

5905VG/1

94-delig assortiment gereedschappen voor autoschade herstel.

► Autobiel onderhoud

Aantal/Omschrijving	Beta Nr.
1 doorslagen Ø 4 mm	30
6 Ø 2 - 3 - 4 - 5 - 6 - 8 mm	31/B6N
1 centerpunt Ø 4 mm	32
1 koudbeitels 150 mm	34
1 ritsbeitels 150 mm	36
17 ringsteeksleutels 6+22 mm	42
10 haakse inbussleutels Ø 1,5+12 mm	96/B10
1 Verstelbare moersleutels met schaalverdeling, gefosfateerd 300 mm	111EN
12 Dopschroevendraaiers, lange uitvoering, Verchroomd Ø 4+14 mm	943BX
1 koevoet 450 mm	965
1 Waterpomptang met Slip-proof PVC 250 mm	1048N
1 Verstelbare griptang 240 mm	1052
1 verstelbare griptang vorkbekken in aluminium 280 mm	1060AL
1 Zijkniptangen, twee componenten handgreep, industriële afwerking 160 mm	1084GBM
1 moniertang PVC geïsoleerde handgreep 250 mm	1098PL
1 hefboomblikschaar rechte bekken	1122
1 elektricienschaar, rechte bladen	1128BMX
1 Zware combinatietangen, twee componenten handgreep, industriële afwerking = 180 mm	1150GBM
1 Schroevendraaier voor Dzus® schroeven ●	1201E/DZ
4 Schroevendraaiers voor sleufschroeven ● 3x75 - 4x100 - 5,5x150 - 6,5x150 mm	1260
1 schroevendraaier voor sleufschroeven extra korte uitvoering ● 4x30 mm	1260N
2 schroevendraaiers voor sleufschroeven met zeskant ● 10x175 - 12x200 mm	1260E
3 Schroevendraaiers voor Phillips® kruiskop schroeven ⊕ PH0x60 - PH1x80 - PH2x100 mm	1262
1 schroevendraaiers voor Phillips® kruiskopschroeven extra korte uitvoering ⊕ PH1x30 mm	1262N
1 schroevendraaiers voor Phillips® kruiskopschroeven met zeskant ⊕ PH3x175 mm	1262E
7 schroevendraaiers voor Torx® schroeven ⊕ T6 - T8 - T10 - T15 - T20 - T25 - T30	1267TX
1 handtas in komvorm 1350 g	1303
1 handtas in wigvorm	1305
1 handtas in hakvorm	1306
1 handtas in railvorm	1310
1 handtas in diabolovorm met gewelfde baana	1314
1 lepel, gebogen en spits	1326
1 lepel, smalle slanke baan	1327
1 lepel, gebogen brede baan	1330
1 verstelbare carrosserievijl met flexibele platte vijlbladen 9"	1338A
1 rechte platte beitel met handbeschermer	1342PM
1 uitdeukhamer met ronde bolle baan	1345
1 uitdeukhamer met ronde vlakke gewafelde baan Ø 40 mm	1357Z/45
1 bankhamer 300 g	1370
1 kunststof hamer Ø 35 mm	1390
1 rolbandmaat 5 m	1692



€



5905VG/1

2.300,00 059051058

Assortiment aanbevolen in combinatie met C25



5905VG/2

118-delig assortiment gereedschappen

► Automobiel onderhoud

Aantal/Omschrijving	Beta Nr.
6 set van 6 pendrijvers in foudraal van duurzaam polyester	38/B6N
13 ringsteeksleutels 6+14 - 17 - 19 - 22 - 24 mm	42
13 dubbele steeksleutels 6x7 - 8x9 - 10x11 - 12x13 - 14x15 - 16x17 - 18x19 - 20x22 - 21x23 - 24x26 - 25x28 - 27x29 - 30x32 mm	55
3 startersleutels 11x13 - 14x17 - 19x22 mm	83
10 haakse inbussleutels \odot 1,5+12 mm	96N/B10
6 schroevendraaiers voor Torx® schroeven \odot T10 - T15 - T20 - T25 - T30 - T40	97TTX
2 1/2" slagdoppen aansluitvierkant \odot 17 - 19 mm	720
20 1/2" dopsleutels, zeskant \odot 10+24 - 26 - 27 - 28 - 30 - 32 mm	920A
1 1/2" verlengstuk 125 mm	920/21
1 1/2" verlengstuk 255 mm	920/22
1 1/2" cardangewricht	920/25
1 1/2" wringstaaf	920/42
1 1/2" omschakelbare ratel \odot	920/55
8 T - sleutels met cardangewricht en zeskanttop \odot 7 - 8 - 10 - 11 - 13 - 14 - 17 - 19 mm	952
1 bougiesleutels met cardangewricht en T - handgreep	959
1 kruissleutel \odot 17x19x22x \blacksquare 1/2"	979
1 borgveertangen, inwendig rechte punten \odot 180 mm	1032
1 borgveertangen, inwendig 90° gebogen punten \odot 170 mm	1034
1 borgveertangen, uitwendig rechte punten \bullet 175 mm	1036
1 borgveertangen, uitwendig 90° gebogen punten \bullet 175 mm	1038
1 Waterpomptang met Slip-proof PVC 250 mm	1048N
1 Verstelbare griptang 240 mm	1052
1 Zijknijptangen, twee componenten handgreep, industriële afwerking \odot 160 mm	1084GBM
1 hefboomblikschaar rechte bekken 250 mm	1122
1 elektricienschaar, rechte bladen	1128BMX
1 Zware combinatietangen, twee componenten handgreep, industriële afwerking \equiv 180 mm	1150GBM
1 Telefoontangen, extra lange halfronde gegroefde bekken, twee componenten handgreep, industriële afwerking \bullet 160 mm	1166GBM
8 Schroevendraaiers voor sleufschroeven \bullet 2,5x50 - 3x75 - 3,5x100 - 4x125	1260
5,5x125 - 6,5x150 - 8x200 - 10x200 mm	1260E
2 schroevendraaiers voor sleufschroeven met zeskant \bullet 10x200 - 12x250 mm	1260N
1 schroevendraaier voor sleufschroeven extra korte uitvoering \bullet 6,5x30 mm	1262
4 Schroevendraaiers voor Phillips® kruiskop schroeven \oplus PH0x60 - PH1x80 - PH2x100 - PH3x150 mm	1370
1 bankhamer 400 g	1390
1 kunststof hamer \odot 35 mm	1491
1 oliefiltersleutel, verstelbaar	1491
1 spanningsmeter 3+48 V	1498

€ 

5905VG/2 2.140,00 059051044

Assortiment aanbevolen in combinatie met C25

5908VG/2T

Assortiment van 214 gereedschappen in voorgevormde ABS inlegbakken

► Auto herstel

Aantal/Omschrijving

- 16 ringsteeksleutels 6÷21 mm
- 5 ringsteeksleutels 22 - 24 - 27 - 30 - 32 mm
- 5 pendrijvers Ø 2 - 3 - 4 - 5 - 6 mm
- 1 centerpunt Ø 4 mm
- 12 dubbele steeksleutels 6x7 - 8x9 - 10x11 - 12x13 - 14x15 - 16x17 - 18x19 - 20x22 - 21x23 - 24x26 - 27x29 - 30x32 mm
- 9 haakse inbussleutels Ø 1,5 - 2 - 2,5 - 3 - 4 - 5 - 6 - 8 - 10 mm
- 5 1/2" schroevendraaiertoppen voor inbusschroeven Ø 5 - 6 - 8 - 10 - 12 mm
- 1 1/2" verlengstuk 125 mm
- 1 1/2" verlengstuk 255 mm
- 1 1/2" cardangewricht
- 1 1/2" wringstaaf
- 1 1/2" omschakelbare ratel Ⓞ
- 19 1/2" dopsleutels, zeskant Ø 10÷24 - 26 - 27 - 30 - 32 mm
- 1 borgveertangen, inwendig rechte punten Ø 180 mm
- 1 borgveertangen, inwendig 90° gebogen punten Ø 170 mm
- 1 borgveertangen, uitwendig rechte punten ● 175 mm
- 1 borgveertangen, uitwendig 90° gebogen punten ● 175 mm
- 1 borgveertangen, inwendig rechte punten Ø 140 mm
- 1 borgveertangen, inwendig rechte punten Ø 225 mm
- 1 borgveertangen, uitwendig rechte punten ● 140 mm
- 1 borgveertangen, uitwendig rechte punten ● 225 mm
- 9 Schroevendraaiers voor sleufschroeven ● 3x75 - 3x100 - 4x100 - 4x150 - 5,5x100 - 5,5x150 - 6,5x150 - 8x150 - 10x200 mm
- 2 schroevendraaier voor sleufschroeven extra korte uitvoering ● 4x30 - 6,5x30 mm
- 7 Schroevendraaiers voor Phillips® kruiskop schroeven ⚙ PH0x60 - PH0x100 - PH1x80 - PH1x120 - PH2x100 - PH2x150 - PH3x150 mm
- 2 schroevendraaiers voor Phillips® kruiskopschroeven extra korte uitvoering ⚙ PH1x30 - PH2x30 mm
- 8 T - sleutels met cardangewricht en zeskantdop Ø 7 - 8 - 10 - 12 - 13 - 14 - 17 - 19 mm
- 2 schroevendraaier voor Phillips® kruiskopschroeven lange uitvoering ⚙ PH1x400 - PH2x400 mm
- 3 schroevendraaier voor verzonken sleufschroeven lange uitvoering ● 3x300 - 4x400 - 5x400 mm
- 6 schroevendraaiers voor Torx® schroeven ⚙ T10-T15-T20-T25-T27-T30
- 12 1/2" slagdoppen aansluitvierkant Ø 10-13-17-18-19-21-22-24-27-30-32 mm
- 1 1/2" verlengstuk voor slagdoppen 125 mm
- 3 Ø 17-19-21
- 5 Dopsleutels voor binnenzeskant schroeven Ø 5L - 6L - 7L - 8L - 10L
- 4 1/2" schroevendraaiertoppen met Torx® doppen ⚙ T40L - T45L - T55L - T70L
- 3 Schroevendraaier-doppen met XZN® profiel Ø M6L - M8L - M12L
- 5 halfzoete vijlen 200 mm
- 1 oliefiltersleutel, verstelbaar 110 mm
- 1 Vierkante carterplug dopsleutel ■ 10 mm
- 7 Zeskant carterplug dopsleutel Ø 8-9-10-11-12-14-17 mm
- 4 Vierkante carterplug dopsleutel Ø 8-9,5-12-13 mm
- 1 Driehoekige carterplug dopsleutel Δ
- 1 Carterplug dopsleutel met XZN® profiel Ø
- 1 Carterplugsleutels
- 2 koudbeitels, geprofileerd model 100 - 200 mm
- 1 bankhamer 300 g
- 1 kunststof hamer Ø 35 mm
- 1 Waterpomptang met Slip-proof PVC 250 mm
- 1 Verstelbare griptang 240 mm
- 1 Combinatietangen ■ 180 mm
- 1 Telefoon tang, lange platte gegroefde bekken ● 160 mm
- 1 Zijkniptangen, zware uitvoering ⚡ 160 mm
- 11 3/4" dopsleutels, zeskant Ø 22-24-27-30-32-34-36-38-41-46-50 mm
- 1 3/4" verlengstuk 200 mm
- 1 3/4" verlengstuk 380 mm
- 1 3/4" wringstaaf 450 mm
- 1 3/4" omschakelbare ratel Ⓞ
- 1 kunststof inleg
- 4 haakse stiftsleutels gebruneerd Ø 13-14-17-19 mm
- 1 Verstelbare moersleutel 300 mm
- 1 koevoet
- 1 blikschaar 250 mm
- 1 elektricienschaar, rechte bladen
- 1 bankhamer 1000 g
- 1 voelermaat
- 1 flexibele magneet
- 1 inspectiespiegel
- 1 schraapstaal, driekantig model 200 mm
- 1 zaagbeugel 440 mm
- 1 Remschoenborstel
- 1 metalen oliekan met pomp, 200 cl
- 1 afbrekmes, plat model

Beta Nr.	TR
	42
	42
	31
	32
	55
96N/SC9	T31
920ME	T80
920/21	T80
920/22	T80
920/25	T80
920/42	T80
920/55	T80
920A	T80
1032	T145
1034	T145
1036	T145
1038	T145
1032	T146
1032	T146
1036	T146
1036	T146
1260	T167
1260N	T167
1262	T168
1262N	T168
952	T63
1262L	T209
1264L	T209
97TTX	T55
720	T111
720/21	T111
720LC	T111
920PE	T113
920TX	T113
920XZN	T113
1719BMA&S5	T236
1491	T264
1494	T264
1494E	T264
1494Q	T264
1494T	T264
1494XZN	T264
1496C	T264
35	T234
1370	T234
1390	T234
1048N	T153
1052	T153
1150	T138
1166	T138
1084	T138
928A	T105
928/21	T106
928/22	T106
928/42	T106
928/55	T106
VP6	VP6
96N	
111E	
965	
1112	
1128BMX	
1370	
1708/20	
1712	
1715	
1717B	
1726	
1737NX	
1751N	
1771	



T05 T06 T31



T80 T145 T146



T167 T168 +96N +1771



T63 T209



T55 T111 T113 T236



T264 T234 T153 T138



T105 T106 VP6



€

5908VG/2T 4.380,00 059081017

Assortiment aanbevolen in combinatie met RSC28

5935VG/1MB

Assortiment van 98 gereedschappen voor ladenblok C35, in voorgevormde EVA foam inlegbakken



MB12



MB39



MB46

► Auto herstel

Aantal/Omschrijving

- 21 ringsteeksleutels 6-7-8-9-10-11-12-13-14-15-16-17-18-19-20-21-22-24-27-30-32 mm
- 8 dubbele steeksleutels 6x7-8x9-10x11-12x13-14x15
16x17-18x19-20x22 mm
- 1 Waterpomptang met Slip-proof PVC 250 mm
- 4 Schroevendraaiers voor sleufschroeven ● 3x75-4x100-5x125-6,5x150 mm
- 3 Schroevendraaiers voor Phillips® kruiskop schroeven ⚙ PH0x60-PH1x80--PH2x100 mm
- 6 schroevendraaiers voor Torx® schroeven ⚙ T8-T10-T15-T20-T25-T30
- 9 Haakse stiftsleutels met kogelkop ○
- 6 haakse stiftsleutels met kracht handgreep ○ 2-2,5-3-4-5-6
- 1 Verstelbare griptang 240 mm
- 19 1/2" dopsleutels, zeskant ○ 10-11-12-13-14-15-16-17-18-19-20-21-22-23-24-26-27-30-32 mm
- 1 1/2" verlengstuk 125 mm
- 1 1/2" verlengstuk 250 mm
- 1 1/2" cardangewricht
- 1 1/2" wringstaaf
- 1 1/2" omschakelbare ratel ⚙
- 5 Dopsleutels voor binnenzeskant schroeven ○ 5-6-8-10-12 mm
- 1 borgveertangen, inwendig rechte punten ○ 180 mm
- 1 borgveertangen, inwendig 90° gebogen punten ○ 170 mm
- 1 borgveertangen, uitwendig rechte punten ● 175 mm
- 1 borgveertangen, uitwendig 90° gebogen punten ● 175 mm
- 1 koudbeitels, geprofileerd model 200 mm
- 1 Zijkniptangen, zware uitvoering ⚡ 160 mm
- 1 combinatietang hoogverchroomd ≡ 180 mm
- 1 Telefoontang, lange halfronde gegroefde bekken ● 160 mm
- 1 bankhamer 500 g
- 1 kunststof hamer 35 mm

Beta Nr.	TR
42	MB12
55	MB12
1048N	MB12
1260	MB46
1262	MB46
1267TX	MB46
96BPC/SC9	MB46
96T	MB46
1052	MB46
920A	MB39
920/21	MB39
920/22	MB39
920/25	MB39
920/42	MB39
920/55	MB39
920PE	MB39
1032	MB39
1034	MB39
1036	MB39
1038	MB39
35	MB39
1084BM	MB39
1150BM	MB39
1166BM	MB39
1370	MB39
1390	MB39

€



5935VG/1MB

1.795,00 059351321

Assortiment aanbevolen in combinatie met C35

5940SBK

Assortiment van 124 gereedschappen

► Motorfiets onderhoud

Aantal/Omschrijving

- 1 doorslagen Ø 2 mm
- 1 centerpunt Ø 4 mm
- 1 koudbeitels 125 mm
- 10 ringsteeksleutels 6 - 7 - 8 - 10 - 11 - 12 - 13 - 14 - 17 - 19 mm
- 6 dubbele steeksleutels 6x7 - 8x9 - 10x11 - 12x13 - 14x15 - 16x17 mm
- 9 haakse inbussleutels ○ 1,5 - 2 - 2,5 - 3 - 4 - 5 - 6 - 8 - 10 mm
- 1 ZERO-RESET momentsleutels met klikmechanisme ⚙ 3/8", 10+50 Nm
- 54 Assortiment van 52 zeskant bits, 10 mm en 2 toebehoren
- 17 Doppendoos met 12 dopsleutels en 5 toebehoren
- 1 verloopdop, 1/2" naar 3/8"
- 2 bougiesdopsleutel ○ 14 - 16 mm
- 1 Extra lange buigtang ● 283 mm
- 2 borgveertangen, inwendig rechte punten ○ 140 - 180 mm
- 1 borgveertangen, uitwendig rechte punten ● 140x1,3 mm
- 1 Zijkniptangen, handgreep voorzien van dubbel gelaagde anti slip PVC, industriële afwerking ⚡ 160 mm
- 1 elektricienschaar rechte bladen
- 1 Zware combinatietangen, handgreep voorzien van dubbel gelaagde anti slip PVC, industriële afwerking ≡ 180 mm
- 1 Schroevendraaier voor Dzus® schroeven ●
- 4 Schroevendraaier voor sleufschroeven ● 3x75 - 4x100 - 5,5x100 - 6,5x150 mm
- 3 Schroevendraaier voor Phillips® kruiskop schroeven ⚙ PH0x60 - PH1x80 - PH2x100 mm
- 1 spanningszoeker ●
- 1 bankhamer 300 g
- 1 oliefiltersleutel, verstelbaar
- 1 voelmaat
- 1 mini zaagbeugel
- 1 Bougie borstel
- 1 kunststof oliekan met pomp 250 cc

Beta Nr.	TR
30	
32	
34	
42	
55	
96/SC9	
666/5	
867/C52	
920A/C12X	
910/16	
956C	
1009/LA	
1032	
1036	
1082G	
1128BM	
1150G	
1201E/DZ	
1201E	
1202E	
1254	
1370	
1491	
1708/13	
1725CR	
1737	
1754	

€



5940SBK

1.335,00 059401082

Assortiment is aanbevolen voor gebruik met artikel C41S - C41H - C42S - C42H - C42S - C41S

5941VU/M

Assortiment van 64 gereedschappen voor koffer C41H, in gevormde EVA foam inlegbakken

► Universeel gebruik

Aantal/Omschrijving

- 16 ringsteeksleutels 6-7-8-9-10-11-12-13-14-15-16-17-18-19-21-22 mm
- 9 haakse inbussleutels ○
- 1 rolbandmaat 5 m
- 19 1/2" dopsleutels, zeskant ○ 10-11-12-13-14-15-16-17-18-19-20-21-22-23-24-26-27-30-32 mm
- 1 1/2" cardangewricht
- 1 1/2" wringstaaf
- 1 1/2" omschakelbare ratel Ⓞ
- 2 1/2" verlengstuk met kogelkop 125-250 mm
- 1 Verstelbare moersleutel 250 mm
- 1 Waterpomptang met Slip-proof PVC 250 mm
- 1 ⚓ 160 mm
- 1 elektricienschaar, rechte bladen 145 mm
- 1 Zware combinatietangen, twee componenten handgreep, industriële afwerking ≡ 180 mm
- 1 Telefoon tangen, extra lange halfronde gegroefde bekken, twee componenten handgreep, industriële afwerking ● 160 mm
- 3 Schroevendraaiers voor sleufschroeven ● 3,5x100-5,5x125-6,5x150 mm
- 3 Schroevendraaiers voor Phillips® kruiskop schroeven ⊕ PH0-PH1-PH2
- 1 bankhamer 300 g
- 1 afbreekmes, plat model 18 mm

Beta Nr.	TR
42	MC12
96/SC9	MC12
1692/5	MC12
920A	MC21
920/25	MC21
920/42	MC21
920/55	MC21
920AN	MC21
111E	
1048N	
1082GBM	
1128BMX	
1150GBM	
1166GBM	
	1260
	1262
	1370
	1771



MC21



MC12



5941VU/M

€ 912,00 059411002

Assortiment aanbevolen in combinatie met C41

Beta

► Universeel gebruik

Aantal/Omschrijving

- 21 Ringsteeksleutels 6-7-8-9-10-11-12-13-14-15-16-17-18-19-20-21-22-24-27-30-32 mm
 9 Haakse stiftsleutels met kogelkop ○ 1,5-2-2,5-3-4-5-6-8-10 mm
 1 bithouderdop ○ 1/4 - □ 1/4
 1 bithouderdop ○ 1/4 - □ 3/8
 1 bithouderdop ○ 5/16 - □ 1/2
 13 1/4" dopsleutels, zeskant ○ 4-4,5-5-5,5-6-7-8-9-10-11-12-13-14 mm
 9 1/4" Dopsleutels zeskant, lange uitvoering ○ 5-6-7-8-9-10-11-12-13 mm
 5 1/4" schroevendraaiersdoppen voor inbusschroeven ○ 3-4-5-6-7 mm
 4 Schroevendraaiersdoppen voor sleufschroeven ● 0,8x4-1x5,5x1,2x6,5-1,2x8 mm
 4 Schroevendraaiersdoppen voor Phillips® kruiskopschroeven ⊕ PH1-PH2-PH3-PH4
 7 Schroevendraaiersdoppen voor Torx® schroeven ⊕ T10-T15-T20-T25-T27-T30-T40
 1 Verloopstuk 1/4" naar 3/8" □ 1/4 - ■ 3/8
 1 1/4" verlengstuk 50 mm
 1 1/4" verlengstuk 100 mm
 1 1/4" verlengstuk 150 mm
 1 1/4" cardangewricht
 1 1/4" steekhecht 176 mm
 1 1/4" wringstaaf met schuifstuk 115 mm
 1 1/4" omschakelbare ratel ⊗ 125 mm
 17 zeskant dopsleutels 3/8" ○ 6-7-8-9-10-11-12-13-14-15-16-17-18-19-20-21-22 mm
 1 □ 3/8 - ■ 1/4
 1 verloopdop, 1/2" naar 3/8" □ 3/8 - ■ 1/2
 1 verlengstuk - 3/8" 125 mm
 1 verlengstuk - 3/8" 250
 1 3/8" cardangewricht
 1 3/8" wringstaaf met schuifstuk 210 mm
 1 3/8" omschakelbare ratel ⊗ 200 mm
 21 1/2" dopsleutels, zeskant ○ 8-10-11-12-13-14-15-16-17-18-19-20-21-22-23-24-26-27-28-30-32 mm
 1 Verloopdop 1/2" naar 3/8" □ 1/2 - ■ 3/8
 1 1/2" cardangewricht
 1 1/2" verlengstuk met kogelkop 125 mm
 1 1/2" verlengstuk met kogelkop 250 mm
 1 1/2" wringstaaf 305 mm
 1 1/2" omschakelbare ratel ⊗ 275 mm
 3 3/8" Bougiedopsleutels ○ 16 mm (5/8")-17,8 (11/16")-20,8 (13/16")
 6 Schroevendraaier voor sleufschroeven ● 0,8x2,5x50-0,8x3x75-0,8x4x100-1,0x5,5x125-1,2x6,5x150-1,2x8x200 mm
 1 Schroevendraaier voor sleufschroeven, extra-korte uitvoering ● 0,8x4x30 mm
 4 Schroevendraaier voor Phillips® kruiskop schroeven ⊕ PH0x60-PH1x80PH2x100PH3x150 mm
 1 Schroevendraaier voor Phillips® kruiskop schroeven. Extra- korte uitvoering ⊕ PH1x30 mm
 12 Schroevendraaiers voor Torx® schroeven ⊕ T06-T07-T08-T09-T10-T15-T20-T25-T27-T30-T40-T45
 1 spanningszoeker ● 0,5x3,5x100 mm
 1 borgveertangen, inwendig rechte punten ○ 180 mm
 1 borgveertangen, inwendig 90° gebogen punten ○ 170 mm
 1 borgveertangen, uitwendig rechte punten ● 175 mm
 1 borgveertangen, uitwendig 90° gebogen punten ● 175 mm
 1 Waterpomptang met Slip-proof PVC 250 mm
 1 Verstelbare griptang 240 mm
 1 Verstelbare griptang 240 mm
 1 Zijkniptangen 160 mm
 1 Moniertangen 220 mm
 1 elektricienschaar rechte bladen
 1 combinatietang hoogverchroomd ≡ 180 mm
 1 Telefoontang, lange halfronde gegroefde bekken ● 160 mm
 3 doorslagen Ø 2-3-4 mm
 6 pendrijvers Ø 2-3-4-5-6-8 mm
 1 centerpunt Ø 4 mm
 1 koudbeitels 150 mm
 2 koudbeitels, geprofileerd model 200-250 mm
 1 ritsbeitels 125 mm
 1 bankhamer 500 g
 1 kunststof hamer Ø 35 mm
 1 rolbandmaat 3 m
 1 Telescopische magneet met flexibele kop
 1 Halfzoeten vijlen, vierkant met handgreep 200 mm
 1 Halfzoeten vijlen, driehoek met handgreep 200 mm
 1 Halfzoeten vijlen, plat met handgreep 200 mm
 1 Halfzoeten vijlen, half rond met handgreep 200 mm
 1 Halfzoeten vijlen, rond met handgreep 200 mm
 1 Remschoenborstel
 1 afbreekmes, plat model

Beta Nr.	TR
42	MM11
96BPC/SC9	MM11
895/1	MM105
895/3	MM105
895/6	MM105
900	MM105
900L	MM105
900ME	MM105
900LP	MM105
900PH	MM105
900TX	MM105
900/16	MM105
900/20	MM105
900/20L	MM105
900/21	MM105
900/25	MM105
900BG/30	MM105
900/42	MM105
900/55	MM105
910A	MM105
910/15	MM105
910/16	MM105
910/21	MM105
910/22	MM105
910/25	MM105
910/42	MM105
910/55	MM105
920A	MM105
920/15	MM105
920/25	MM105
920AN	MM105
920AN	MM105
920/42	MM105
920/55	MM105
956E	MM105
1201E	MM210
1201EN	MM210
1202E	MM210
1202EN	MM210
1207E/TX	MM210
1253	MM210
1032	MM129
1034	MM129
1036	MM129
1038	MM129
1048N	MM129
1052	MM129
1052	MM129
1082BM	MM129
1098	MM129
1128BM	MM129
1150BM	MM129
1166BM	MM129
30	MM230
31	MM230
32	MM230
34	MM230
35	MM230
36	MM230
1370	MM230
1390	MM230
1692	MM230
1712TF	MM230
1719BMA...Q	MM230
1719BMA...T	MM230
1719BMA...P	MM230
1719BMA...M	MM230
1719BMA...R	MM230
1737NX	MM230
1771	MM230



MM11



MM105



MM129



MM210



MM230



5945VUM 2.980,00 059451011

Assortiment is aanbevolen in combinatie met artikel C45

5954VG

138-delig assortiment gereedschappen

► Automobiël onderhoud

Aantal/Omschrijving	Beta Nr.
5 pendrijvers Ø 2-3-4-5-6 mm	31
1 centerpunt Ø 4 mm	32
1 koudbeitels 125 mm	34
18 ringsteeksleutels 6÷22 - 24 mm	42
8 dubbele steeksleutels 6x7 - 8x9 - 10x11 - 12x13 - 14x15 - 16x17 - 18x19 - 20x22 mm	55
3 ringsleutels, diepgebogen 12x13 - 14x15 - 17x19 mm	90
13 haakse inbussleutels Ø 2÷10 - 12 mm	96
4 1/2" slagdoppen aansluitvierkant Ø 17 - 19 - 21 - 22 mm	720
20 1/2" dopsleutels, zeskant Ø 10-11-12-13-14-15-16-17-18-19-20-21-22-23-24-26-27-28-30-32 mm	920A
1 1/2" verlengstuk	920/21
1 1/2" verlengstuk	920/22
1 1/2" cardangewricht	920/25
1 1/2" wringstaaf	920/42
1 1/2" omschakelbare ratel	920/55
3 Dopschroevendraaiers, lange uitvoering. Verchroomd Ø 8 - 10 - 13 mm	943BX
10 T - sleutels met cardangewricht en zeskantdop Ø 6 - 7 - 8 - 10 - 11 - 12 - 13 - 14 - 17 - 19 mm	952
3 bougieopsleutel Ø 16 - 17,8 - 20,8 mm	956C
1 koevoet	964
1 borgveertangen, inwendig rechte punten	1032
1 borgveertangen, inwendig 90° gebogen punten	1034
1 borgveertangen, uitwendig rechte punten	1036
1 borgveertangen, uitwendig 90° gebogen punten	1038
1 Waterpomptang met Slip-proof PVC 250 mm	1048N
1 Verstelbare griptang 240 mm	1052
1 verstelbare griptang lange bekken 175 mm	1058
1 Zijknijptangen 160 mm	1082BM
1 elektricienschaar, rechte bladen	1128BMX
1 combinatietang hoogverchroomd 180 mm	1150BM
1 Telefontang, lange halfronde gegroefde bekken 160 mm	1166BM
1 spanningszoeker 6÷24V	1254
1 Schroevendraaiers voor sleufschroeven 8 x 200 mm	1260
1 schroevendraaier voor sleufschroeven extra korte uitvoering 6,5x30 mm	1260N
1 Schroevendraaiers voor Phillips® kruiskop schroeven 8 x 150 mm	1262
1 schroevendraaiers voor Phillips® kruiskopschroeven extra korte uitvoering PH2x30 mm	1262N
5 schroevendraaiers voor Torx® schroeven T8 - T10 - T15 - T20 - T25	1267TX
8 schroevendraaiers	1263/D8
1 bankhamer 300 g	1370
1 terugslagvrije hamer Ø 35 mm	1392
1 remveertang 210 mm	1470
1 kabelschoentang voor niet - geïsoleerde	1603
1 rolbandmaat 5 m	1692
1 voelermat	1708/20
1 flexibele magneet 1,8 kg	1712E/2
6 Naaldvijlen 160 mm	1720/B6
1 kunststof oliekan met pomp 150 cc	1754



€



5954VG

2.540,00 059541054

Assortiment aanbevolen in combinatie met C54VG

5957VG

Assortiment van 174 gereedschappen

► Automobiel onderhoud



Aantal/Omschrijving	Beta Nr.
6 pendrijvers Ø 2 - 3 - 4 - 5 - 6 - 8 mm	31/SP6
6 beitels in houder	38/SP6
17 ringsteeksleutels 6-7-8-10-11-12-13-14-15 16-17-19-21-22-24-27-30 mm	42
12 dubbele steeksleutels 6x7 + 30x32 mm	55/S12X
8 haakse stiftsleutels met kracht handgreep 2 + 10 mm	96T/S8
1 haakse inbussleutels Ø 2,5 + 12 mm	96N/G7
8 haakse stiftsleutels voor Torx® schroeven ⌘ T9 + T40	97TX/SC8
5 Haakse stiftsleutels met XZN® profiel Ø M5 + M12	98XZN/B5
1 Verstelbare moersleutel 250 mm	111E
1 ZERO-RESET momentsleutels met klikmechanisme ⌘ 1/2", 40+200 Nm	666/20
13 1/2" zeskant dopsleutels op dophouder Ø 10+22 mm	920A/SB13
8 1/2" zeskant dopsleutels op dophouder Ø 23+32 mm	920A/SB8
4 schroevendraaiers voor sleufschroeven ● 1,2x6,5 - 1,2x8 - 1,6x9 - 2x12 mm	920LP
3 schroevendraaiers voor Phillips® kruiskopschroeven ⌘ PH2 - 3 - 4	920PH
1 1/2" verlengstuk 125 mm	920/21
1 1/2" verlengstuk 255 mm	920/22
1 1/2" cardangewicht	920/25
1 1/2" wringstaaf	920/42
1 1/2" omschakelbare ratel ⌘	920/55
2 1/2" slagdoppen aansluitvierkant Ø 17 - 19 mm	720
10 T - sleutels met cardangewicht en zeskantdop Ø 7 - 8 - 10 - 11 - 12 - 13 - 14 - 15 - 17 - 19 mm	952
3 bogjesleutels met cardangewicht en T - handgreep 14 - 16 - 20,8 mm	959
1 puntschop	963
1 kruissleutel ⌘ ■ 1/2" - 17 - 19 - 22 mm	979
2 borgveertangen, inwendig rechte punten Ø 140 - 180 mm	1032
2 borgveertangen, inwendig 90° gebogen punten Ø 130 - 170 mm	1034
2 borgveertangen, uitwendig rechte punten ● 140x1,3 - 175 mm	1036
2 borgveertangen, uitwendig 90° gebogen punten ● 135x1,3 - 175 mm	1038
1 Waterpomp tang met Slip-proof PVC 250 mm	1048N
1 Verstelbare griptang 240 mm	1052
1 Zijknijptangen ⌘ 160 mm	1082BM
1 Zijknijptangen, zware uitvoering ⌘ 160 mm	1084BM
1 hefboom kopknijptang ⌘ 180 mm	1092V
1 blikschaar 250 mm	1112
1 elektricienschaar, rechte bladen	1128BMX
1 combinatietang hoogverchroomd ≡ 180 mm	1150BM
1 Telefoontang, lange halfronde gegroefde bekken ● 160 mm	1166BM
1 Telefoontang, lange halfronde gebogen bekken ● 200 mm	1168BM
2 Schroevendraaiers voor sleufschroeven ● 8x200 - 10x200 mm	1260
1 Schroevendraaiers voor Phillips® kruiskop schroeven ⌘ PH3x150 mm	1262
8 Schroevendraaiers	1263/D8
2 bankhamer 300 - 600 g	1370
1 kunststof hamer Ø 35 mm	1390
11 Tapeind uithalers met rol en 1/2" insteek vierkant M5+M16 mm	1433/C11
1 oliefiltersleutel, verstelbaar	1491
1 spanningsmeter	1498
1 rolbandmaat 5 m	1692
1 voelermaat	1708/20
1 flexibele magneet 1,8 kg	1712E/2
1 schraapstaal, half rond model 200 mm	1717A
1 schraapstaal, driekantig model 200 mm	1717B
5 halfzoete vijlen 200 mm	1719BMA8/S5
1 zaagbeugel	1725
1 metalen oliekan met pomp 200 cc	1751
1 afbreekmes, plat model	1771
1 Schuifmaat	1650

€ 

5957VG 4.450,00 059571007

Assortiment is aanbevolen voor gebruik met artikelen C57S A - C57S B - C57SP - RSC50 PS - C55PS - C55PSE

VOORGEVORMDE ZACHTE INLEGBAKKEN

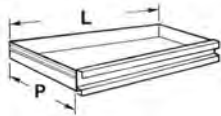

RSC23T
RSC24
RSC24A
RSC24AXL
RSC24L/7
RSC24L-CAB
RSC28
C30M
C37
C37A
C39
C39T
C39MD
C39SM
RSC51
C57S
C59
RSC55

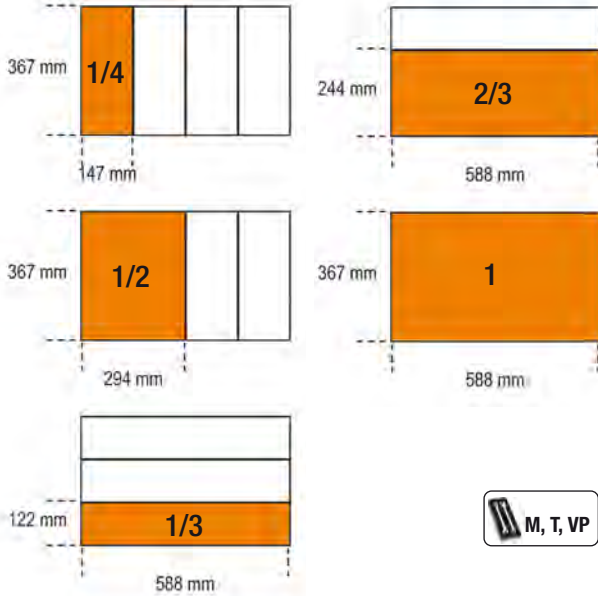

533÷543
549÷558

M, T, VP

M01



42 6 - 7 - 8 - 9 - 10 - 11 - 12 - 13 - 14 - 15 - 16 - 17 - 18 - 19 - 20 - 21 - 22 - 24 - 27 - 30 - 32 - 36 mm

4,5 kg



M01	€ 439,00	1	024500001
MV10	77,00	1	024510010

M02



42 6 - 7 - 8 - 9 - 10 - 11 - 12 - 13 - 14 - 15 - 16 - 17 - 18 - 19 - 20 - 21 - 22 - 23 - 24 - 25 - 26 - 27 - 28 - 29 - 30 - 32 mm

6,3 kg



M02	€ 484,00	1	024500002
MV02	77,00	1	024510002

M05



42 6-7-8-9-10-11-12 - 13-14-15-16-17 - 18-19-20-21 mm

1,5 kg



M05	€ 210,50	1	024500005
MV15	37,00	1	024510015

M06



42 22-24-27-30-32 mm

2,1 kg



M06	€ 149,00	1	024500006
MV16	48,50	1	024510016

M13



42SLIM 8-10-11-12 - 13-14-15-16-17 - 18-19 mm

1,2 kg



M13	€ 158,00	1	024500013
MV13	37,00	1	024510013

M25

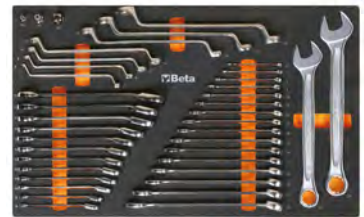

42 6 - 7 - 8 - 9 - 10 - 11 - 12 - 13 - 14 - 15 - 16 - 17 - 18 - 19 - 21 - 22 - 24 - 27 mm
90 6x7 - 8x9 - 10x11 - 12x13 - 14x15 - 16x17 - 18x19 mm
123Q1/4
123Q3/8
123Q1/2
142 8 - 9 - 10 - 11 - 12 - 13 - 14 - 15 - 16 - 17 - 18 - 19 mm

5,1 kg



M25	€ 757,00	1	024500025
MV25	77,00	1	024510873

M30



55 6x7 - 8x9 - 10x11 - 12x13 - 14x15 - 16x17 - 18x19 - 20x22 - 21x23 - 24x27 - 30x32 mm
90 6x7 - 8x9 - 10x11 - 12x13 - 14x15 - 16x17 - 18x19 - 20x22 - 21x23 - 24x27 - 30x32 mm
96BPC/SC9 1,5 - 2 - 2,5 - 3 - 4 - 5 - 6 - 8 - 10 mm

4,2 kg



M30	€ 447,00	1	024500030
MV30	77,00	1	024510030

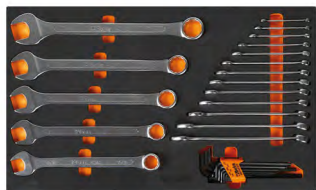

M31

42AS 1/4 - 9/32 - 5/16 - 3/8 - 7/16 - 1/2 - 9/16
- 19/32 - 5/8 - 11/16 - 3/4 - 13/16 - 7/8 -
15/16 - 1 - 1.1/16 - 1.1/8 - 1.1/4
96BP/AS-SC9 1/16 - 3/32 - 1/8 - 5/32 - 3/16 - 7/32 - 1/4
- 5/16 - 3/8

5,7 kg



M31	432,00	1	024500031
MV31	77,00	1	024510031

M33



55 6x7-8x9-10x11
12x13-14x15
16x17-18x19
20x22 mm
96/SC9 1,5+10 mm

1,1 kg



M33	104,50	1	024500033
MV33	37,00	1	024510033

M38



55 21x23-24x26
27x29-30x32 mm

1,7 kg



M38	87,00	1	024500038
MV38	48,50	1	024510038

M39



31 2-3-4-5-6-8 mm
32 4 mm
55 6x7 - 8x9 - 10x11 - 12x13 - 14x15 - 16x17
- 18x19 - 20x22 - 21x23 - 24x26 - 25x28
- 27x29 - 30x32 mm
96/SC12 2 - 2,5 - 3 - 3,5 - 4 - 4,5 - 5 - 6 - 7 - 8 - 9
- 10 mm
96 12-14-17-19 mm

5,7 kg



M39	349,00	1	024500039
MV39	77,00	1	024510039

M40



90 6x7-8x9-10x11
12x13-14x15
16x17-18x19 mm

810 g



M40	121,50	1	024500040
MV40	37,00	1	024510040

M44



141 8-9-10-11-12
13-14-15-16
17-18-19 mm

1,3 kg



M44	311,00	1	024500044
MV44	37,00	1	024510044

M45



142 8-9-10-11-12
13-14-15-16
17-18-19 mm

1,3 kg



M45	356,00	1	024500045
MV45	37,00	1	024510045

M46



142SN 8-9-10-11-12
13-14-15-16
17-18-19 mm

1,4 kg



M46	421,00	1	024500046
MV46	37,00	1	024510046

M49



52MQ 7 - 8 - 10 - 11 - 12 - 13 - 14 - 15 - 16 - 17
- 19 - 22 mm
89MQ 7 - 8 - 10 - 11 - 12 - 13 - 14 - 15 - 16 - 17
- 19 - 22 mm

3,3 kg



M49	1.169,00	1	024500049
MV49	77,00	1	024510049

M50



96T 2-2,5-3-4-5
6-7-8 mm

1,1 kg



M50	131,50	1	024500050
MV50	48,50	1	024510051

M52



96T 2,5-3-4-5-6 mm



330 g



M52	77,50	1	024500052
MV52	37,00	1	024510052

M53



96TBP 2,5-3-4-5-6 mm



350 g



M53	81,00	1	024500053
MV52	37,00	1	024510052

M55



97TTX T10-T15-T20-T25-T30



330 g



M55	84,00	1	024500055
MV55	37,00	1	024510055

Beta

Quality Tools

M60



96T 2 - 2,5 - 3 - 4 - 5 - 6 - 7 - 8 - 10 mm
 97BTX/SC8 T9 - T10 - T15 - T20 - T25 - T27 - T30 - T40
 944BX 5-6-7-8-10-13 mm



1,9 Kg



M60	409,00	1	024500060
MV60	77,00	1	024510060

M62



97TTX T10 - T15 - T20 - T25 - T27 - T30 - T40 - T45 - T50
 1032 180 mm
 1034 170 mm
 1036 175 mm
 1038 175 mm
 1177BM 140 mm
 1188BM 125 mm
 1257LP 2-2,5-3-3,5 mm
 1257PH 0-00



2,3 kg



M62	467,00	1	024500875
MV62	77,00	1	024510875

M63



952 7 - 8 - 10 - 12 - 13 - 14 - 17 - 19 mm



3,4 kg



M63	388,00	1	024500063
MV63	77,00	1	024510063

M65

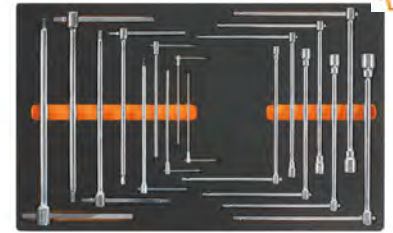

950 8 - 10 - 12 - 13 - 14 - 17 - 19 mm
 951 2,5 - 3 - 4 - 5 - 6 - 8 - 10 - 12 - 14 mm



3,6 Kg



M65	564,00	1	024500065
MV65	77,00	1	024510065

M67

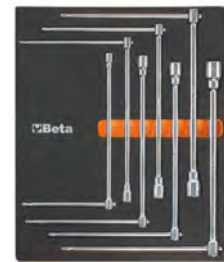

950 7-8-10-12-13-17 mm



1,8 kg



M67	214,50	1	024500067
MV67	48,50	1	024510067

M69



951 2,5-3-4-5-6-8-10-12-14 mm



1,8 kg



M69	320,00	1	024500069
MV69	48,50	1	024510069

M75



933 7-8-9-10-11-12-13-14-15-16-17-18-19-21-22-24 mm



5,5 kg



M75	466,00	1	024500075
MV75	77,00	1	024510075



M78

17



80 6x7 - 8x9 - 10x11 - 12x13 - 14x15 - 16x17 - 18x19 mm

- 920/36A
- 965 450 mm
- 1052 240 mm
- 1058 175 mm
- 1481PL/A
- 1481PL/B
- 1481PL/C
- 1650 150 mm
- 1708/20
- 1716P

4,4 kg

M78	758,00	1	024500878
MV77	77,00	1	024510876

M79

6



80 8x9 - 10x11 - 12x13 - 14x15 16x17 - 18x19 mm

1,3 kg

M79	327,00	1	024500079
MV79	37,00	1	024510079

M82

29



- 920A 10-11-12-13-14 - 15-16-17-18-19 - 20-21-22-23-24 - 26-27-30-32 mm
- 920ME 5-6-8-10-12 mm
- 920AN/125 125 mm
- 920AN/250 250 mm
- 920/25 255 mm
- 920/42 305 mm
- 920/55

4,1 kg

M82	470,00	1	024500082
MV82	48,50	1	024510082

M83

24



- 920A 10-11-12-13-14 - 15-16-17-18-19 - 20-21-22-23-24 - 26-27-30-32 mm
- 920AN/125 125 mm
- 920AN/250 250 mm
- 920/25 255 mm
- 920/42 305 mm
- 920/55

3,7 kg

M83	371,00	1	024500083
MV83	48,50	1	024510083

M85

45



- 851SR 230 mm
- 860LP 0,5x3 - 0,6x4,5 - 0,8x5,5 - 1x5,5 - 1,2x6,5 mm
- 860PE 2 - 2,5 - 3 - 4 - 5 - 6 - 8 - 10 mm
- 860PH PH0 - PH1 - PH2 - PH3 - PH4
- 860PZ PZ1 - PZ2 - PZ3 - PZ4
- 860TX T6 - T7 - T8 - T9 - T10 - T15 - T20 - T25 - T27 - T30 - T40
- 860RTX T9 - T10 - T15 - T20 - T25 - T27 - T30 - T40
- 860/55 100 mm
- 882P 80 mm
- 892 1/4 - 1/2

450 g

M85	229,50	1	024500085
MV85	37,00	1	024510085

M86

46



- 867PE 4-5-6-7-8-10-12 mm
- 867PE/L 4-5-6-7-8-10-12 mm
- 867XZN 5-6-8-10-12 mm
- 867XZN/L 5-6-8-10-12 mm
- 867TX T20 - T25 - T30 - T40 - T45 - T50 - T55
- 867TX/L T25 - T30 - T40 - T45 - T50 - T55
- 867RTX T20 - T25 - T30 - T40 - T45 - T50 - T55
- 867/1
- 867/2

1,4 kg

M86	176,50	1	024500086
MV86	37,00	1	024510086

M91

25



- 900 4 - 4,5 - 5 - 5,5 - 6 - 7 - 8 - 9 - 10 - 11 - 12 - 13 - 14 mm
- 900ME 2,5-3-4-5-6-8 mm
- 900/20 50 mm
- 900/21 150 mm
- 900/25 1/4 - 1/2
- 900BG/30
- 900/42
- 900/55

560 g

M91	264,00	1	024500091
MV90	37,00	1	024510090

M92

22



- 910A 6-7-8-9-10-11-12-13-14-15-16-17-18-19-20-21-22 mm
- 910/21 125 mm
- 910/22 250 mm
- 910/25
- 910/42
- 910/55

1,5 kg

M92	289,00	1	024500092
MV92	37,00	1	024510092

M94

26



- 900AS/L 3/16 - 7/32 - 1/4 - 9/32 - 5/16 - 11/32 - 3/8 - 7/16 - 1/2 - 9/16
- 900AS 3/16 - 7/32 - 5/32 - 1/4 - 9/32 - 5/16 - 11/32 - 3/8 - 7/16 - 1/2 - 9/16
- 900AN 50-100mm
- 900/25
- 900/55
- 900/42

930 g

M94	305,00	1	024500094
MV94	37,00	1	024510094

M96

22



- 920A/AS 3/8 - 7/16 - 1/2 - 9/16 - 19/32 - 5/8 - 11/16 - 3/4 - 25/32 - 13/16 - 7/8 - 15/16 - 1 - 1.1/16 - 1.1/8 - 1.3/16 - 1.1/4
- 920/25
- 920AN 125-250mm
- 920/42
- 920/55

3,8 kg

M96	380,00	1	024500096
MV96	48,50	1	024510096

M100

98



- 895/1
- 895/3
- 895/6
- 900 4 - 4,5 - 5 - 5,5 - 6 - 7 - 8 - 9 - 10 - 11 - 12 - 13 - 14 mm
- 900L 5 - 6 - 7 - 8 - 9 - 10 - 11 - 12 - 13 mm
- 900ME 3-4-5-6-7 mm
- 900LP 0,8x4 - 1x5,5 - 1,2x6,5 - 1,2x8 mm
- ⊕ 900PH PH1-PH2-PH3-PH4
- ⊕ 900TX T10 - T15 - T20 - T25 - T27 - T30 - T40
- 900/20 50 mm
- 900/20L 100 mm
- 900/21 150 mm
- 900/25
- 900BG/30
- 900/42
- ⊕ 900/55
- 920A 8-10-11-12-13-14-15-16-17-18-19-20-21-22-23-24-26-27-28-30-32 mm
- 920/15
- 920/25
- 920AN/125 125 mm
- 920AN/250 250 mm
- 920/42
- ⊕ 920/55
- ⊕ 920FTX 10 - 12 - 14 - 16 - 18 - 20 - 22 - 24 mm
- 920AL 10 - 12 - 13 - 14 - 15 - 16 - 17 - 18 - 19 - 21 - 22

6,7 Kg

14" 12"



M100	1.325,00	1	024500100
MV100	77,00	1	024510100

M105

116



- 900 4 - 4,5 - 5 - 5,5 - 6 - 7 - 8 - 9 - 10 - 11 - 12 - 13 - 14 mm
- 900L 5 - 6 - 7 - 8 - 9 - 10 - 11 - 12 - 13 mm
- 96BPC/SC9 1,5 - 2 - 2,5 - 3 - 4 - 5 - 6 - 8 - 10 mm
- 895/1
- 895/3
- 895/6
- 900ME 3-4-5-6-7 mm
- 900LP 0,8x4 - 1x5,5 - 1,2x6,5 - 1,2x8 mm
- ⊕ 900PH PH1-PH2-PH3-PH4
- ⊕ 900TX T10 - T15 - T20 - T25 - T27 - T30 - T40
- 900/16 □ 1/4 - ■ 3/8
- 900/... 50-100-150 mm
- 900/25
- 900BG/30
- 900/42
- ⊕ 900/55
- 910A 6 - 7 - 8 - 9 - 10 - 11 - 12 - 13 - 14 - 15 - 16 - 17 - 18 - 19 - 20 - 21 - 22 mm
- 910/15 □ 3/8 - ■ 1/4
- 910/16 □ 3/8 - ■ 1/2
- 910/21 125 mm
- 910/22 250 mm
- 910/25
- 910/42
- ⊕ 910/55
- 920A 8 - 10 - 11 - 12 - 13 - 14 - 15 - 16 - 17 - 18 - 19 - 20 - 21 - 22 - 23 - 24 - 26 - 27 - 28 - 30 - 32 mm
- 920/15 □ 1/2 - ■ 3/8
- 920/25
- 920AN 125 - 250 mm
- 920/42
- ⊕ 920/55
- 956E 16-17,8-20,8 mm

7,7 kg

14" 38" 12"



M105	1.450,00	1	024500871
MV105	77,00	1	024510871

M108

27



- 910MQ/PE 4-5-6-8 mm
- 910MQ/B 7 - 8 - 10 - 11 - 12 - 13 - 14 - 15 - 16 - 17 - 19 mm
- ⊕ 910MQ/TX T15 - T20 - T25 - T27 - T30 - T40
- 910MQ/XZN 8-10 mm
- 910MQ/21 125 mm
- 910MQ/22 250 mm
- 910MQ/T
- 910MQ/55

2,7 kg



M108	1.255,00	1	024500108
MV108	77,00	1	024510108

M110

36



- ⊕ 850MQ
- ⊕ 860TX/A10
- 920MQ/A 8 - 9 - 10 - 11 - 12 - 13 - 14 - 15 - 16 - 17 - 18 - 19 - 20 mm
- 920MQ/PE 5-6-8-10-12 mm
- 920MQ/21 125 mm
- 920MQ/22 250 mm
- 920MQ/55A
- 943MQ 6-7-8-10 mm

3,1 kg



M110	1.270,00	1	024500110
MV110	77,00	1	024510110

M112

32



- ⊕ 861TX ● 1/4-T6+T15
- ⊕ 866TX ● 5/16-T20+T55
- 895/1 ○ 1/4x□1/4
- 895/6 ○ 5/16x□1/2
- ⊕ 900FTX □ 1/4-E4+E10
- ⊕ 920FTX □ 1/2-E12+E24
- ⊕ 920TX □ 1/2-T55L-T60-T70L

1,3 kg

14" 12"



M112	352,00	1	024500112
MV112	37,00	1	024510112

M115

54



- ⊕ 666/20 40=200 Nm
- 920A 13 - 14 - 15 - 16 - 17 - 18 - 19 - 20 - 21 - 22 - 24 - 26 - 27 - 30 - 32 mm
- ⊕ 920FTX 12 - 14 - 16 - 18 - 20 - 22 - 24 mm
- 920PE 6 - 7 - 8 - 8L - 10 - 10L - 12 - 12L - 14 - 14L
- ⊕ 920TX T20 - T25 - T27 - T30 - T40 - T45 - T50 - T55 - T60 - T20L - T25L - T27L - T30L - T40L - T45L - T50L
- 920/21 125 mm
- 920/22 255 mm
- 920/25
- 920/42 305 mm
- ⊕ 920/55

7,8 Kg

12"



M115	1.245,00	1	024500115
MV115	77,00	1	024510115



M120

75



- 920A 10-11-12-13-14-15-16-17-18-19-20-21
22-24-26-27-30-32 mm
- 920AN/125 125 mm
- 920AN/250 250 mm
- 920/25
- 920/42
- 920AL 10 - 12 - 13 - 14 - 15 - 16 - 17 - 18 - 19 -
22 - 24 - 27 - 30 - 32 mm
- ⊗ 920FTX 10 - 12 - 14 - 16 - 18 - 20 - 22 - 24 mm
- ⊗ 920/55
- 920PE 5 - 5L - 6 - 6L - 7 - 7L - 8 - 8L - 10 - 10L
- 12 - 12L - 14 - 14L
- ⊗ 920TX T20-T25-T27-T30-T40-T45-T50-T55-T60
T20L-T25L-T27L-T30L-T40L-T45L-T50L

6,9 Kg

12"



M120	1.410,00	1	024500120
MV120	77,00	1	024510120

M121

46



- 920BP 5L - 6L - 8L - 10L - 5XL - 6XL - 8XL mm
- ⊗ 920TX T20 - T25 - T27 - T30 - T40L - T45L
- T50L - T55L - T60L - T70L
- 920XZN 4 - 5 - 6 - 6L - 8 - 8L - 10 - 10L - 12 - 12L
- 14 - 14L - 16 - 18 mm
- ⊗ 920ES 7 - 9 - 10 - 11 - 12L - 14L - 16L - 7XL -
9XL - 10XL - 11XL - 12XL - 14XL - 16XL
mm

920/36A

6,3 Kg

12"



M121	1.345,00	1	024500121
MV121	77,00	1	024510121

M125

68



- 910AL 8 - 9 - 10 - 11 - 12 - 13 - 14 - 15 - 16 - 17
- 19 - 21 - 22 mm
- 920PE 5-6-6L-7-8-8L-10-10L-12-12L mm
- ⊗ 920FTX E12 - E14 - E16 - E18 - E20 - E22 - E24
- ⊗ 920TX T20 - T25 - T27 - T30 - T30L - T40 - T40L
- T45 - T50 - T50L - T55 - T60 - T60L
- 920XZN 5 - 6 - 6L - 8 - 8L - 10 - 10L - 12L mm
- 920AL 10 - 12 - 13 - 14 - 15 - 16 - 17 - 18 - 19
- 21 - 22 - 23 - 24 - 27 - 30 - 32 mm
- 1692/5 5 m

7,9 kg

38" 12"



M125	1.385,00	1	024500872
MV125	77,00	1	024510872

M126

26



- 928A 19 - 21 - 22 - 24 - 26 - 27 - 28 - 30 - 32
- 34 - 35 - 36 - 38 - 41 - 46 mm
- 928ME 14-17-19-22 mm
- 928/15 □ 3/4 - ■ 1/2
- 928/16 □ 3/4 - ■ 1
- 928/21 200 mm
- 928/22 380 mm
- 928/25 450 mm
- 928/42 450 mm
- ⊗ 928/55

12,4 kg

34"



M126	1.085,00	1	024500126
MV126	77,00	1	024510126

M127

23



- 728 19 - 21 - 22 - 24 - 27 - 30 - 32 - 33 - 34
- 35 - 36 - 38 - 40 - 41 - 46
- ⊗ 728FTX 20-22-24 mm
- 728/15 □ 3/4 - ■ 1/2
- 728/16 □ 3/4 - ■ 1
- 728/21 175 mm
- 728/22 250 mm
- 728/25

12,5 kg

34"



M127	1.058,00	1	024500127
MV127	77,00	1	024510127

M128

50



- 720 10 - 11 - 12 - 13 - 14 - 15 - 16 - 17 - 18
- 19 - 21 - 22 - 24 - 27 - 30 - 32 mm
- 720L 10 - 11 - 12 - 13 - 14 - 15 - 16 - 17 - 18
- 19 - 21 - 22 - 24 - 27 - 30 - 32 mm
- ⊗ 720TX T30-T40-T45-T50-T55
- 720ME 5 - 6 - 8 - 10 - 12 - 14 - 17 - 19 mm
- 720LC 17-19-21 mm
- 720/21 125 mm
- 720/25

8,9 kg

12"



M128	1.069,00	1	024500128
MV128	77,00	1	024510128

M129

13



- 1032 180 mm
- 1034 170 mm
- 1036 175 mm
- 1038 175 mm
- 1048N 250 mm
- 1052 240 mm
- ⊗ 1082BM 160 mm
- 1098 220 mm
- 1112 250 mm
- 1128BM
- 1150BM 180 mm
- 1166BM 160 mm
- 1168BM 160 mm

3,4 Kg



M129	499,00	1	024500129
MV138	77,00	1	024510138

M133

3



- ⊗ 1082G 160 mm
- 1150G 180 mm
- 1166G 160 mm

650 g



M133	93,00	1	024500133
MV133	37,00	1	024510133

M134

3



- ⊗ 1082GBM 160 mm
- 1150GBM 180 mm
- 1166GBM 160 mm

750 g



M134	119,00	1	024500134
MV134	37,00	1	024510134

M135



- 1082MQ 160 mm
- 1150MQ 180 mm
- 1166MQ 160 mm



750 g



M135	147,50	1	024500135
MV135	37,00	1	024510135

M136



- 1084BM 160 mm
- 1150BM 180 mm
- 1166BM 160 mm



750 g



M136	134,50	1	024500136
MV131	37,00	1	024510131

M137



- 1084 160 mm
- 1150 180 mm
- 1166 160 mm



650 g



M137	110,50	1	024500137
MV132	37,00	1	024510132

M145



- 1032 180 mm
- 1034 170 mm
- 1036 175 mm
- 1038 175 mm



640 g



M145	141,00	1	024500145
MV145	37,00	1	024510145

M153



- 1048N 250 mm
- 1052 240 mm



1 kg



M153	110,50	1	024500153
MV154	37,00	1	024510154

M161



- 1128MQ
- 1048MQ 250 mm
- 1082MQ 160 mm
- 1150MQ 180 mm
- 1162MQ 160 mm
- 1164MQ 160 mm
- 1272MQ PH0x60 - PH1x80 - PH2x100 - PH3x150 mm
- 1274MQ 2,5x75 - 3x100 - 4x100 - 5,5x125 mm
- 1777MQ/U



3,0 kg



M161	522,00	1	024500161
MV161	77,00	1	024510161

M162



- 1241 5,5x100 - 6,5x125 - 8x150 - 10x200 mm
- 1242 PH1x100 - PH2x100 - PH3x150 - PH4x200 mm



1,4 kg



M162	155,50	1	024500162
MV162	48,50	1	024510162

Beta

Quality Tools

M166



860MIX/A31

- 1048N 250 mm
- 1082BM 160 mm
- 1150BM 180 mm
- 1162BM 160 mm
- 1290 3x75 - 4x100 - 5,5x100 - 6,5x150 - 8x150 mm
- 1290N 6,5x30 mm
- 1292 4,5x80 - 6x100 - 8x150 mm
- 1292N 6x30 mm
- 1297TX T20-T25-T27-T30

2,9 kg



M166	523,00	1	024500879
MV880	77,00	1	024510880

M170



- 1290 2,5x50 - 3x75 - 3,5x100 - 4x125 - 5,5x100 - 5,5x150 - 6,5x150 mm



500 g



M170	86,00	1	024500170
MV170	37,00	1	024510170

M172



- 1292 PH0x60 - PH0x100 - PH1x80 - PH1x120 - PH2x100 - PH2x150 mm



450 g



M172	77,50	1	024500172
MV172	37,00	1	024510172



M174

6



1297TX T8 - T10 - T15 - T20
- T25 - T30

450 g



M174	116,00	1	024500174
MV174	37,00	1	024510174

M180

7



1290 3x75
4x100
5,5x150
6,5x150 mm

1292 PH0x60
PH1x80
PH2x100 mm

500 g



M180	89,00	1	024500180
MV180	37,00	1	024510180

M195

25



1260 2,5x50 - 3x75 - 4x100 - 5,5x125 - 6,5x150
- 8x200 mm

1260N 4x30 mm

1262 PH0x60 - PH1x80 - PH2x100 - PH3x150
mm

1262N PH1x30 mm

1267TX T6 - T7 - T8 - T9 - T10 - T15 - T20 - T25
- T27 - T30 - T40 - T45

1253 3,5x100 mm

2,3 kg



M195	347,00	1	024500195
MV195	77,00	1	024510195

M201

6



1260 3x75 - 4x100 -
6,5x150 mm

1262 PH0x60 - PH1x80 -
PH2x100 mm

500 g



M201	87,00	1	024500201
MV201	37,00	1	024510201

M204

6



1267TX T8 - T10 - T15 - T20
- T25 - T30

450 g



M204	86,00	1	024500204
MV204	37,00	1	024510204

M208

10



1260 3x75
3,5x100
4x125
5,5x150
6,5x150 mm

1262 PH0x60
PH1x80
PH2x100 mm
4x30 mm

1260N 4x30 mm

1262N PH1x30 mm

750 g



M208	98,00	1	024500208
MV208	48,50	1	024510208

M209

10



1260N 4x30 mm

1264 2,5x60 - 3x100 -
4x125 - 5x150 -
6,5x150 mm

1262 PH0x60 - PH1x80 -
PH2x100 mm

1262N PH1x30 mm

820 g



M209	98,00	1	024500209
MV208	48,50	1	024510208

M213

25



1201E 2,5x50 - 3x75 - 4x100 - 5,5x125 - 6,5x150
- 8x200 mm

1201EN 4x30 mm

1202E PH0x60 - PH1x80 - PH2x100 - PH3x150
mm

1202EN PH1x30 mm

1207E/TX T6 - T7 - T8 - T9 - T10 - T15 - T20 - T25
- T27 - T30 - T40 - T45

1253 3,5x100 mm

1,8 Kg



M213	233,50	1	024500213
MV210	77,00	1	024510210

M214

7



1201E 2,5x50 - 3x75 -
3,5x100
- 4x125 - 5,5x100 -
5,5x150 - 6,5x150 mm

500 g



M214	48,00	1	024500214
MV211	37,00	1	024510211

M216

6



1202E PH0x60 - PH1x80
- PH1x120 - PH2x100
- PH2x150 - PH3x150
mm

450 g



M216	51,50	1	024500216
MV212	37,00	1	024510212

M217

7

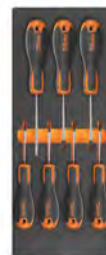

1207E/TX T6 - T7 - T8 - T9 - T10
- T15 - T20

500 g



M217	68,00	1	024500217
MV215	37,00	1	024510215



M218



- 1201E 3x75
4x100
5,5x150
6,5x150 mm
- ⊕ 1202E PH0x60
PH1x80
PH2x100 mm

500 g



M218	€ 50,00	1	024500218
MV220	€ 37,00	1	024510220

M219



- ⊕ 1202E 3x60 - 4,5x80 - 6x100 mm
- 1204E 3x75 - 4x100 - 5x150 - 6,5x150 mm

590 g



M219	€ 50,00	1	024500219
MV220	€ 37,00	1	024510220

M222



- ⊕ 1272MQ PH0x60 mm
- ⊕ 1272MQF PH1x80 - PH2x100 mm
- 1274MQF 3,5x100 - 4,5x100 - 5,5x125 - 6,5x150 mm

540 g



M222	€ 134,50	1	024500222
MV222	€ 37,00	1	024510222

M226



- 1274MQ 3x100
4x100
5,5x125
6,5x150 mm
- ⊕ 1272MQ PH0x60
PH1x80
PH2x100 mm

500 g



M226	€ 104,00	1	024500226
MV226	€ 37,00	1	024510226

M227



- 944BX 6-7-8-10-13 mm

420 g



M227	€ 139,00	1	024500227
MV227	€ 37,00	1	024510227

M230



- 30 Ø 2-3-4 mm
- 31 Ø 2-3-4-5-6-8 mm
- 32 Ø 4 mm
- 34 150 mm
- 35 200-250 mm
- 36 125 mm
- 1370 500 g
- 1390 Ø 35 mm
- 1692 3 m
- 1712TF
- 1719BMA/Q 200 mm
- ▲ 1719BMA/T 200 mm
- 1719BMA/P 200 mm
- ▶ 1719BMA/M 200 mm
- 1719BMA/R 200 mm
- 1737NX
- 1771 18 mm

3,2 Kg



M230	€ 443,00	1	024500230
MV230	€ 77,00	1	024510230

M231



- 31 2-3-4-5-6-8 mm
- 32 4 mm
- 34 125-150-175 mm
- 36 125 mm
- 1370 500-1000 g
- 1390 Ø 35 mm
- 1712TF 590 mm
- 1715 670 mm
- 1719BMA/Q 200 mm
- ▲ 1719BMA/T 200 mm
- 1719BMA/P 200 mm
- ▶ 1719BMA/M 200 mm
- 1719BMA/R 200 mm
- 1737NX

4,7 kg



M231	€ 424,00	1	024500877
MV231	€ 77,00	1	024510877

M234



- 35 100-200 mm
- 1370 300 g
- 1390 Ø 35 mm

1,3 kg



M234	€ 117,00	1	024500234
MV232	€ 37,00	1	024510232

M236



- 1719BMA/Q 200 mm
- ▲ 1719BMA/T 200 mm
- 1719BMA/P 200 mm
- ▶ 1719BMA/M 200 mm
- 1719BMA/R 200 mm

870 g



M236	€ 107,50	1	024500236
MV236	€ 37,00	1	024510236



M237



35 100-200 mm
1370T 300 mm
1390N Ø 35 mm

1,3 kg



M237	127,50	1	024500237
MV232	37,00	1	024510232

M240



31BM Ø 2-3-4-5-6-8 mm
32 Ø 4 mm

850 g



M240	136,00	1	024500240
MV240	37,00	1	024510240

M264



1491 Ø 65+110 mm
1494 ■ 10 mm
1494E ○ 8 - 9 - 10 - 11 - 12 - 14 - 17 mm
1494Q ○ 8-9,5-12-13 mm
1494T △ 9,5
1494XZN ○ 16
1496C ■ 8x 10 mm

2,1 kg



M264	260,00	1	024500264
MV264	37,00	1	024510264

Beta

Quality Tools

M284



1128BMX
1130BMX
1719BMA...Q 200 mm
1719BMA...P 200 mm
1719BMA...M 200 mm
1719BMA...R 200 mm
1726BM 400 mm
1728BM (5)
1771BM 170 mm
1778V18 185 mm

2,4 kg



M284	276,00	1	024500284
MV284	77,00	1	024510284

M292



111E 250 mm
1128BMX
1692/5 5 m
1771 170 mm

500 g



M292	128,50	1	024500292
MV293	37,00	1	024510293

M294



1692/5 5 m
1725CR 260 mm
1771 18 mm
1771RL

500 g



M294	89,50	1	024500294
MV294	37,00	1	024510294

M295



1650
1682 L=300 mm
1707
1708/20

450 g



M295	135,50	1	024500295
MV295	37,00	1	024510295

M305



1927B
720 12-13-14-15-16-17
18-19-21-22
24-27 mm
720/21

4,2 kg



M305	451,00	1	024500305
MV305	48,50	1	024510305

M310



1927CD
720 12-13-14-15-16-17
18-19-21-22
24-27 mm
720/21

4,0 kg



M310	684,00	1	024500310
MV310	48,50	1	024510310

Beta

Beta

M400



- 3932U
- 3935 120 mm
- 3937 170 mm
- 3952 13 - 14 - 15 - 16 - 17 - 18 - 19 mm
- 3961 3,2
- 3961 3,3
- 3961 3,5
- 3961U 3,2 - 4,0 mm
- 3969 200 mm (x2)
- 3969K3 113 mm
- 3973/1
- 3973/2
- 3973/3
- 3973/4
- 3984/1 Ø35 mm
- 3984/2 Ø22,8 mm
- 3984/3 Ø23,5 mm
- 3984/4 Ø23 mm
- 3991
- 3992 234 mm

3,1 kg



	€	1	024500400
M400	662,00	1	024500400
MV400	77,00	1	024510400

M401



- 3921 440 mm
- 3948
- 3953
- 3955 30x32 - 32x36 mm
- 3967 289 mm
- 3971

2,7 kg



	€	1	024500401
M401	419,00	1	024500401
MV401	77,00	1	024510401

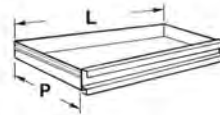

RSC22
RSC23
RSC23C
C27S

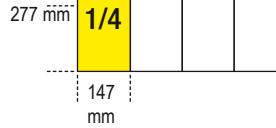

543
559



C41S
C41H

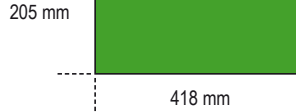

543



MC10



- 42 6-7-8-9-10-11-12
13-14-15-16-17
18-19-21-22 mm
- 96/SC9 1,5 - 2 - 2,5 - 3 - 4 - 5 - 6 - 8 - 10 mm
- ⚡ 1084BM 160 mm
- ≡ 1150G 180 mm
- 1166G 160 mm
- 1201E 3,5x100 - 5,5x150 - 6,5x150 mm
- ⊕ 1202E PH0x60 - PH1x80 - PH2x100 mm

3,5 kg



	€	1	027500011
MC10	405,00	1	027500011
MCV10	53,00	1	027510010

MC12



- 42 6 - 7 - 8 - 9 - 10 - 11 - 12 - 13 - 14 - 15 - 16 - 17
- 18 - 19 - 21 - 22 mm
- 96/SC9 1,5 - 2 - 2,5 - 3 - 4 - 5 - 6 - 8 - 10 mm
- 1692/5 5 m

2,2 kg



	€	1	041500012
MC12	259,00	1	041500012
MCV11	50,00	1	041510011

MC20



- 860MIX/A31
- 895/1
- 1048N 250 mm
- 1370 300 g
- 32 Ø 4 mm
- 36 Ø 4 mm
- 900 4 - 4,5 - 5 - 5,5 - 6 - 7 - 8 - 9 - 10 - 11 - 12 - 13 - 14 mm
- 900/21 150 mm
- 900/25
- 900BG/30C
- 900/42
- 900/55
- 920A 10 - 11 - 12 - 13 - 14 - 15 - 16 - 17 - 18 - 19 - 21 - 22 - 24
- 27 - 30 - 32 mm

- 920/25
- 920AN/125 125 mm
- 920/42
- 920/55

6 kg



	€	1	027500020
MC20	677,00	1	027500020
MCV20	53,00	1	027510021

MC21



- 920A 10 - 11 - 12 - 13 - 14 - 15 - 16 - 17 - 18 - 19 - 20
- 21 - 22 - 23 - 24 - 26 - 27 - 30 - 32 mm
- 920/25
- 920/42
- ⊕ 920/55
- 920AN 125-250 mm

4,3 kg



	€	1	041500021
MC21	371,00	1	041500021
MCV21	50,00	1	041510021

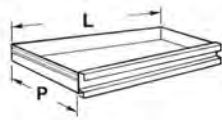

C35

447 mm
1
600 mm

544÷546



MB12

30



42 6-7-8-9-10-11-12-13-14-15-16-17-18-19-20-21-22-24-27-30-32 mm
55 6x7-8x9-10x11
12x13-14x15
16x17-18x19
20x22 mm
1048N 250 mm

5,4 kg

€		
MB12	612,00	1 024504212
MBV13	201,00	1 024524213

MB37

52



920A 10-11-12-13-14-15-16-17-18-19-20-21-22-23-24-26-27-30-32 mm
920/21 125 mm
920/22 150 mm
920/25
920/42
920/55
111E 250 mm
1052 240 mm
1084BM 160 mm
1150BM 180 mm
1166BM 160 mm
1032 180 mm
1034 170 mm
1036 175 mm
1038 175 mm
900 4-4,5-5-5,5-6-7-8-9-10-11-12-13-14 mm
900/20 50 mm
900/21 150 mm
900/25
900BG/30
900/55
900/42

7,0 kg

€		
MB37	998,00	1 024504237
MBV40	201,00	1 024524240

MB38

80



96T 2-2,5-3-4-5-6-7-8 mm
851SR 230 mm
860LP 0,5x3-0,6x4,5-0,8x5,5-1x5,5-1,2x6,5 mm
860PE 2-2,5-3-4-5-6-8-10 mm
860PH PH0 - PH1 - PH2 - PH3 - PH4
860PZ PZ1 - PZ2 - PZ3 - PZ4
860RTX T9 - T10 - T15 - T20 - T25 - T27 - T30 - T40
860TX T6 - T7 - T8 - T9 - T10 - T15 - T20 - T25 - T27 - T30 - T40
860/55 100 mm
882P
892/0
920A 10-11-12-13-14-15-16-17-18-19-20-21-22-23-24-26-27-30-32 mm
920/21 125 mm
920/22 255 mm
920/25
920/42
920/55
1084BM 160 mm
1150BM 180 mm
1166BM 160 mm

5,9 kg

€		
MB38	863,00	1 024504238
MBV35	201,00	1 024524235



MB39

39



920A 10-11-12-13-14-15-16-17-18-19-20-21-22-23-24-26-27-30-32 mm
920/21 125 mm
920/22 255 mm
920/25
920/42
920/55
920PE 5-6-8-10-12 mm
1032 180 mm
1034 170 mm
1036 175 mm
1038 175 mm
35 200 mm
1084BM 160 mm
1150BM 180 mm
1166BM 160 mm
1370 500 g
1390 35 mm

7,2 kg

€		
MB39	840,00	1 024504239
MBV36	201,00	1 024524236

MB44

34



1260 2,5x50-3x75-3,5x100-4x100-5,5x125-6,5x150-8x200 mm
1260N 4x30-6,5x30 mm
1262 PH0x60 - PH0x100 - PH1x80 - PH1x120 - PH2x100 - PH2x150 - PH3x150 mm
1262N PH1x30-PH2x30 mm
1253
96BPC/SC9 951 2,5-3-4-5-6-8 mm

2,8 kg

€		
MB44	417,00	1 024504244
MBV44	201,00	1 024524244

MB45

29



- 1260 2,5x50 - 3x75 - 3,5x100 - 4x100 - 5,5x100 - 5x125 - 6,5x150 mm
- ⊕ 1262 PH0x60 - PH0x100 - PH1x80 - PH1x120 - PH2x100 - PH2x150 mm
- ⊗ 1267TX T8 - T10 - T15 - T20 - T25 - T30
- 1052 240 mm
- 96BPC/SC9

2,8 kg



MB45	€ 313,00	1	024504245
MBV45	€ 201,00	1	024524245

MB46

29



- 1260 3x75 - 4x100 - 5,5x125 - 6,5x150 mm
- ⊕ 1262 PH0x60 - PH1x80 - - - PH2x100 mm
- ⊗ 1267TX T8 - T10 - T15 - T20 - T25 - T30
- 96BPC/SC9
- 96T 2-2,5-3-4-5-6
- 1052 240 mm

2,8 kg



MB46	€ 346,00	1	024504246
MBV46	€ 201,00	1	024524246

MB47

48



- 1260 3x75 - 4x100 - 5,5x125 - 6,5x150 mm
- ⊕ 1262 PH0x60 - PH1x80 - - - PH2x100 mm
- 1260N 4x30 mm
- ⊕ 1262N PH1x30 mm
- 96T 2,5-3-4-5-6-8 mm
- 96BPC/SC9
- 920A 10 - 11 - 12 - 13 - 14 - 15 - 16 - 17 - 18 - 19 - 20 - 21 - 22 - 23 - 24 - 26 - 27 - 30 - 32 mm
- 920/21 125 mm
- 920/22 250 mm
- 920/25
- 920/42
- ⊗ 920/55

5,6 kg

12"



MB47	€ 670,00	1	024504247
MBV47	€ 201,00	1	024524247

MB56

15

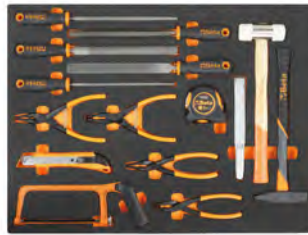

- 1719BMA/Q 200 mm
- ▲ 1719BMA/T 200 mm
- 1719BMA/P 200 mm
- ▶ 1719BMA/M 200 mm
- 1719BMA/R 200 mm
- 1032 180 mm
- 1034 170 mm
- 1036 175 mm
- 1038 175 mm
- 1370T 300 g
- 1390N Ø 35 mm
- 35 200 mm
- 1692 5 mt
- 1725CR 260 mm
- 1771 18 mm

3,7 kg



MB56	€ 406,00	1	024504256
MBV56	€ 201,00	1	024524256

MB58

17



- 31 Ø 2-3-4-5-6 mm
- 32 Ø 4 mm
- 35 200 mm
- 1112 250 mm
- 1128BMX
- 1370 500 g
- 1390 Ø 45 mm
- 1719BMA...Q 200 mm
- ▲ 1719BMA...T 200 mm
- 1719BMA...P 200 mm
- ▶ 1719BMA...M 200 mm
- 1719BMA...R 200 mm
- 1726 440 mm

4,5 kg



MB58	€ 406,00	1	024504258
MBV55	€ 201,00	1	024524255



MB59

15



- 1719BMA...Q 200 mm
- ▲ 1719BMA...T 200 mm
- 1719BMA...P 200 mm
- ▶ 1719BMA...M 200 mm
- 1719BMA...R 200 mm
- 31 Ø 4-6 mm
- 32 Ø 4 mm
- 35 125-200 mm
- 1370 300 g
- 1390 Ø 35 mm
- 1692 5 mt
- 1725 420 mm
- 1833XS/2

3,4 kg



MB59	€ 337,00	1	024504259
MBV57	€ 201,00	1	024524257

MB65

16



- 1719BMA...Q 200 mm
- 1719BMA...P 200 mm
- 1719BMA...T 200 mm
- 1719BMA...M 200 mm
- 1719BMA...R 200 mm
- 35 200 mm
- 1032 180 mm
- 1034 170 mm
- 1036 175 mm
- 1038 175 mm
- 1052 240 mm
- 1084BM 160 mm
- 1150BM 180 mm
- 1166BM 160 mm
- 1370 500 g
- 1390 Ø 35 mm

4,8 kg



MB65	€ 528,00	1	024504265
MBV61	€ 201,00	1	024524261

MB63



- 96BPC/SC9
- 1250 4x125 mm
- ⊕ 1251 PH1x125 mm
- 1253
- 943MQ 5,5-6-7-8-10-13 mm
- ⊕ 1272MQ PH0x60 - PH1x80 - PH2x100 - PH3x150 mm
- 1274MQ 2,5x75 - 3x100 - 4x100 - 5,5x125 - 6,5x150 - 8x175 mm
- 860LP 0,5x3 - 0,6x4 - 0,8x5,5 - 1,0x5,5 - 1,2x6,5 mm
- 860PE 2 - 2,5 - 3 - 4 - 5 - 6 - 8 - 10 mm
- ⊕ 860PH PH0 - PH1 - PH2 - PH3 - PH4
- ⊕ 860PZ PZ1 - PZ2 - PZ3 - PZ4
- ⊕ 860RTX T9 - T10 - T15 - T20 - T25 - T27 - T30 - T40
- 882MSR 50 ○ 1/4 ● 1/4
- ⊕ 850MQ

3,2 kg



MB63	517,00	1	024504263
MBV63	201,00	1	024524263

MB64



- 55 6x7-8x9-10x11 - 12x13-14x15 - 16x17-18x19 - 20x22 mm
- 1048MQ 250 mm
- 1082MQ 140 mm
- 1128BSX
- 1132MQ 230 mm
- 1142MQ 160 mm
- 1150MQ 180 mm
- 1166MQ 160 mm
- 1168MQ 160 mm
- 110MQ 250 mm
- 1777MQ
- 993MQ
- 1602

4,1 kg



MB64	869,00	1	024504264
MBV62	201,00	1	024524262

C45PRO

566 mm
406 mm
532 mm
34 mm

1

MM

546

MM11



- 42 6 - 7 - 8 - 9 - 10 - 11 - 12 - 13 - 14 - 15 - 16 - 17 - 18 - 19 - 20 - 21 - 22 - 24 - 27 - 30 - 32 mm
- 96BPC/SC9 1,5 - 2 - 2,5 - 3 - 4 - 5 - 6 - 8 - 10 mm

4,5 kg



MM11	404,00	1	024580011
MMV10	77,00	1	024590010

MM26



- 42 6 - 7 - 8 - 9 - 10 - 11 - 12 - 13 - 14 - 15 - 16 - 17 - 18 - 19 - 21 - 22 - 24 - 27 mm
- 111E 250 mm
- 123Q1/4
- 123Q3/8
- 123Q1/2
- 142 8 - 9 - 10 - 11 - 12 - 13 - 14 - 15 - 16 - 17 - 18 - 19 mm

4,3 kg



MM26	697,00	1	024580026
MMV26	77,00	1	024590026

MM30

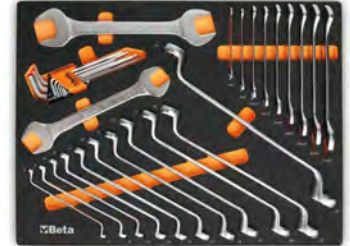

- 55 6x7-8x9-10x11-12x13-14x15-16x17 - 18x19-20x22-21x23-24x27-30x32 mm
- 90 6x7-8x9-10x11-12x13-14x15-16x17 - 18x19-20x22-21x23-24x27-30x32 mm
- 96BPC/SC9 1,5 - 2 - 2,5 - 3 - 4 - 5 - 6 - 8 - 10 mm

4,9 kg



MM30	475,00	1	024580030
MMV30	77,00	1	024590030

MM60



- 96T 2 - 2,5 - 3 - 4 - 5 - 6 - 7 - 8 - 10 mm
- ⊕ 97BTX/SC8 T9-T10-T15-T20-T25-T27-T30-T40
- 944BX 5-6-7-8-10-13 mm

2,2 Kg



MM60	440,00	1	024580060
MMV60	77,00	1	024590060

MM63



- 952 7 - 8 - 10 - 12 - 13 - 14 - 17 - 19 mm

3,4 kg



MM63	421,00	1	024580063
MMV63	77,00	1	024590063



MM100

98



- 895/1
- 895/3
- 895/6
- 900 4 - 4,5 - 5 - 5,5 - 6 - 7 - 8 - 9 - 10 - 11 - 12 - 13 - 14 mm
- 900L 5 - 6 - 7 - 8 - 9 - 10 - 11 - 12 - 13 mm
- 900ME 3-4-5-6-7 mm
- 900LP 0,8x4 - 1x5,5 - 1,2x6,5 - 1,2x8 mm
- ⊕ 900PH PH1-PH2-PH3-PH4
- ⊕ 900TX T10 - T15 - T20 - T25 - T27 - T30 - T40
- 900/20 50 mm
- 900/20L 100 mm
- 900/21 150 mm
- 900/25
- 900BG/30
- 900/42
- ⊕ 900/55
- 920A 8-10-11-12-13-14-15-16-17-18-19-20-21-22-23-24-26-27-28-30-32 mm
- 920/15
- 920/25
- 920AN/125 125 mm
- 920AN/250 250 mm
- 920/42
- ⊕ 920/55
- 920/42 10 - 12 - 14 - 16 - 18 - 20 - 22 - 24 mm
- 920AL 10 - 12 - 13 - 14 - 15 - 16 - 17 - 18 - 19 - 21 - 22

6,7 Kg

MM100	1.325,00	1	024580100
MMV100	77,00	1	024590100



MM129

12



- 1032 180 mm
- 1034 170 mm
- 1036 175 mm
- 1038 175 mm
- 1048N 250 mm
- 1052 240 mm
- ⚡ 1082BM 160 mm
- 1098 220 mm
- 1128BM
- 1150BM 180 mm
- 1166BM 160 mm

2,9 Kg

MM129	468,00	1	024580129
MMV129	77,00	1	024590129



MM210

25



- 1201E 2,5x50 - 3x75 - 4x100 - 5,5x125 - 6,5x150 - 8x200 mm
- 1201EN 4x30 mm
- ⊕ 1202E PH0x60 - PH1x80 - PH2x100 - PH3x150 mm
- ⊕ 1202EN PH1X30 mm
- ⊕ 1207E/TX T6 - T7 - T8 - T9 - T10 - T15 - T20 - T25 - T27 - T30 - T40 - T45
- 1253

2,1 kg

MM210	233,50	1	024580211
MMV210	77,00	1	024590211

Beta

MM105

107



- 895/1 ○1/4-□1/4
- 895/3 ○1/4-□3/8
- 895/6 ○5/16-□1/2
- 900 4 - 4,5 - 5 - 5,5 - 6 - 7 - 8 - 9 - 10 - 11 - 12 - 13 - 14 mm
- 900L 5 - 6 - 7 - 8 - 9 - 10 - 11 - 12 - 13 mm
- 900ME 3-4-5-6-7 mm
- 900LP 0,8x4 - 1x5,5 - 1,2x6,5 - 1,2x8
- ⊕ 900PH PH1-PH2-PH3-PH4
- ⊕ 900TX T10 - T15 - T20 - T25 - T27 - T30 - T40
- 900/16
- 900/... 50-100-150 mm
- 900/25
- 900BG/30 176 mm
- 900/42 115 mm
- ⊕ 900/55 125 mm
- 910A 6 - 7 - 8 - 9 - 10 - 11 - 12 - 13 - 14 - 15 - 16 - 17 - 18 - 19 - 20 - 21 - 22 mm
- 910/15 □3/8-■1/4
- 910/16 □3/8-■1/2
- 910/21 125 mm
- 910/22 250 mm
- 910/25
- 910/42 210 mm
- ⊕ 910/55 200 mm
- 920A 8 - 10 - 11 - 12 - 13 - 14 - 15 - 16 - 17 - 18 - 19 - 20 - 21 - 22 - 23 - 24 - 26 - 27 - 28 - 30 - 32 mm
- 920/15 □1/2-■3/8
- 920/25
- 920AN 125-250 mm
- 920/42 305 mm
- ⊕ 920/55 275 mm
- 956E 16 mm (5/8") - 17,8 (11/16") - 20,8 (13/16")

7,2 kg

14" 3/8" 12"

MM105	1.400,00	1	024580105
MMV105	77,00	1	024590105

MM230

25



30	Ø 2-3-4 mm
31	Ø 2-3-4-5-6-8 mm
32	Ø 4 mm
34	150 mm
35	200-250 mm
36	125 mm
1370	500 g
1390	Ø 35 mm
1692	3 m
1712TF	
1719BMA...Q	200 mm
1719BMA...T	200 mm
1719BMA...P	200 mm
1719BMA...M	200 mm
1719BMA...R	200 mm
1737NX	
1771	

3,2 Kg



MM230	470,00	1	024580230
MMV230	77,00	1	024590230

MM400

29



3932U	
3935	120 mm
3937	170 mm
3952	13 - 14 - 15 - 16 - 17 - 18 - 19 mm
<input type="checkbox"/> 3961 3,2	
<input type="checkbox"/> 3961 3,3	
<input type="checkbox"/> 3961 3,5	
<input type="checkbox"/> 3961U	3,2 - 4,0 mm
3969	200 mm (x2)
3969K3	113 mm
3973/1	
3973/2	
3973/3	
3973/4	
3984/1	
3984/2	
3984/3	
3984/4	
3991	222 mm
3992	234 mm

3,1 kg



MM400	662,00	1	024580400
MMV400	77,00	1	024590400

MM401

7



3921	440 mm
3948	
3953	
3955	30x32 mm - 32x36 mm
3967	289 mm
3971	

2,7 kg



MM401	419,00	1	024580401
MMV401	77,00	1	024590401

VPM0

Zachte voorgevormde inlegbak

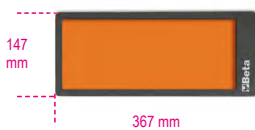

VPM0	31,50	1	088870350
------	-------	---	-----------

VPM3

Zachte voorgevormde inlegbak

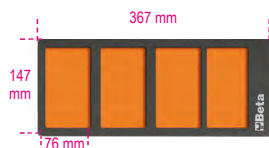

VPM3	31,50	1	088870353
------	-------	---	-----------

VPM7

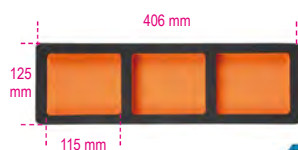

VPM7	32,50	1	088870356
------	-------	---	-----------

VPM8



VPM8	26,00	1	088870357
------	-------	---	-----------

VPM9



VPM9	24,80	1	088870358
------	-------	---	-----------

VPM7-C

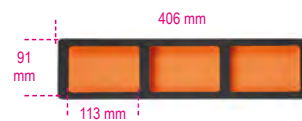

VPM7C	38,50	1	088870360
-------	-------	---	-----------



Voorgevormde harde inlebakken. T series



Assortimenten gereedschappen in voorgevormde inzetbakken voor alle modellen gereedschapskisten en voor gereedschapswagens.

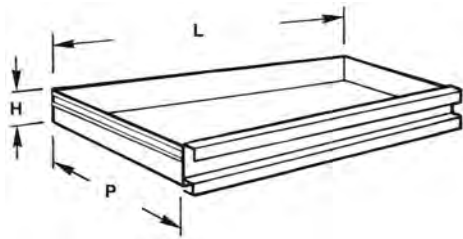

H mm	LxP mm
70	588x367

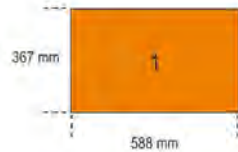
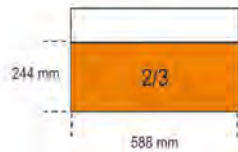
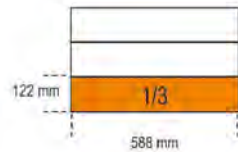
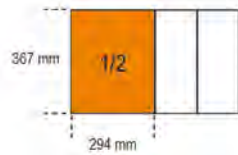
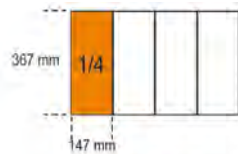

T01



42 6-7-8-10-11-12-13
14-16-17-18-19-21
22-24-27-30 mm

2,7 kg

	€	1	024240001
T01	269,00	1	024240001
TV10	37,50	1	024000400

T05



42 6-7-8-9-10-11-12
13-14-15-16-17
18-19-20-21 mm

1,5 kg

	€	1	024240005
T05	209,00	1	024240005
TV15	28,50	1	024000445

T06



42 22-24-27-30-32 mm

2,1 kg

	€	1	024240006
T06	149,00	1	024240006
TV16	28,50	1	024000446

T18



42MP 6-7-8-9-10-11-12
13-14-15-16-17
18-19-20-21 mm

1,5 kg

	€	1	024240018
T18	308,00	1	024240018
TV15	28,50	1	024000445

T19



42MP 22-24-27-30-32 mm

2,1 kg

	€	1	024240019
T19	199,00	1	024240019
TV16	28,50	1	024000446

T22



42AS 5/16-3/8-7/16-1/2
9/16-5/8-11/16-3/4
96AS/BG7 3/32-1/8-5/32-3/16
1/4-5/16-3/8

1 kg

	€	1	024240022
T22	157,00	1	024240022
TV20	28,50	1	024000488

T23



42INOX 8-10-11-12-13-14-15-17-19 mm
96BPINOX 2,5-3-4-5-6-8-10 mm

1 kg

	€	1	024240023
T23	326,00	1	024240023
TV23	28,50	1	024249906

T31



31 Ø 2-3-4-5-6 mm
32 Ø 4 mm
55 6x7-8x9-10x11
12x13-14x15
16x17-18x19
20x22-21x23
24x26-27x29
30x32 mm
96N/SC9 1,5+10 mm

3 kg

	€	1	024240031
T31	227,50	1	024240031
TV30	37,50	1	024000401

T33



55 6x7-8x9-10x11
12x13-14x15
16x17-18x19
20x22 mm
○ 96/SC9 1,5+10 mm

1 kg



T33	€ 99,00	1	024240033
TV20	€ 28,50	1	024000488

T34



55MP 6x7-8x9-10x11
12x13-14x15
16x17-18x19
20x22 mm
○ 96/SC9 1,5+10 mm

1 kg



T34	€ 129,00	1	024240034
TV20	€ 28,50	1	024000488

T40



90 6x7-8x9-10x11
12x13-14x15
16x17-18x19 mm

810 g



T40	€ 113,50	1	024240040
TV40	€ 28,50	1	024000456

T41



90 20x22-21x23
24x26-25x28
27x29 mm

1,5 kg



T41	€ 172,50	1	024240041
TV41	€ 28,50	1	024000457

T45



142 8-9-10-11-12
13-14-15-16
17-18-19 mm

1,3 kg



T45	€ 346,00	1	024240045
TV45	€ 28,50	1	024000498

T46



142SN 8-9-10-11-12
13-14-15-16
17-18-19 mm

1,5 kg



T46	€ 413,00	1	024240046
TV46	€ 28,50	1	024000499

T48



○ 96BPC/SC9 1,5+10 mm
142C 8-9-10-11-12
13-14-15-16
17-18-19 mm

1,4 kg



T48	€ 292,00	1	024240048
TV47	€ 28,50	1	024000763

T50



○ 96T 2-2,5-3-3,5-4-4,5
5-6-7-8-10 mm

1,3 kg



T50	€ 177,50	1	024240050
TV50	€ 37,50	1	024000764

T52



○ 96T 2-2,5-3-4-5-6 mm

350 g



T52	€ 86,50	1	024240052
TV52	€ 28,50	1	024000765

T55



○ 97TTX T10-T15-T20
T25-T27-T30

330 g



T55	€ 96,50	1	024240055
TV55	€ 28,50	1	024000766

T59



111E 250 mm
920/40 ■ 1/2
951 2,5-3-4-5-6-8 mm
○ 953 4-5-6-8 mm
1370 300 - 500 g

4,7 kg



T59	€ 484,00	1	024240059
TV60	€ 59,00	1	024000420

T63



○ 952 7 - 8 - 10 - 12 - 13 - 14 - 17 - 19 mm

3,8 kg



T63	€ 377,00	1	024240063
TV63	€ 46,00	1	024000471

T64

8



- 952FTX E10-E12-E14
- 953TX T25 - T27 - T30 - T40 - T45

3,8 kg



T64	€ 470,00	1	024240064
TV63	€ 46,00	1	024000471

T65

8



- 953 3 - 3,5 - 4 - 5 - 6 - 7 - 8 - 10 mm

2,8 kg



T65	€ 356,00	1	024240065
TV63	€ 46,00	1	024000471

T68

6



- 951 2,5-3-4-5-6-8 mm

590 g



T68	€ 151,50	1	024240068
TV68	€ 28,50	1	024000470

T73

8



- 930 6x7 - 8x9 - 10x11 - 12x13 - 14x15 - 16x17 - 18x19 - 20x22 mm
- 940/1
- 940/2

1,3 kg



T73	€ 237,00	1	024240073
TV73	€ 28,50	1	024000418

T75

16



- 933 7-8-9-10-11-12-13 - 14-15-16-17-18-19 - 21-22-24 mm

4,2 kg



T75	€ 453,00	1	024240075
TV75	€ 59,00	1	024000422

T76

16



- 932 7-8-9-10-11-12-13 - 14-15-16-17-18-19 - 21-22-24 mm

4,2 kg



T76	€ 453,00	1	024240076
TV75	€ 59,00	1	024000422

T77

10



- 933 6-7-8-10-11-12-13 - 14-17-19 mm

1,4 kg



T77	€ 226,50	1	024240077
TV77	€ 28,50	1	024000474

T80

29



- 920A 10-11-12-13-14 - 15-16-17-18-19 - 20-21-22-23-24 - 26-27-30-32 mm
- 920ME 5-6-8-10-12 mm
- 920/21 125 mm
- 920/22 255 mm
- 920/25
- 920/42 305 mm
- 920/55

4,1 kg

12"



T80	€ 438,00	1	024240080
TV80	€ 37,50	1	024000403

T81

29



- 920B 10-11-12-13-14 - 15-16-17-18-19 - 20-21-22-23-24 - 26-27-30-32 mm
- 920ME 5-6-8-10-12 mm
- 920/21 125 mm
- 920/22 255 mm
- 920/25
- 920/42 305 mm
- 920/55

4,1 kg

12"



T81	€ 438,00	1	024240081
TV80	€ 37,50	1	024000403

T82

29



- 920A 10-11-12-13-14 - 15-16-17-18-19 - 20-21-22-23-24 - 26-27-30-32 mm
- 920ME 5-6-8-10-12 mm
- 920AN/125 125 mm
- 920AN/250 250 mm
- 920/25
- 920/42 305 mm
- 920/55

4,1 kg

12"



T82	€ 457,00	1	024240082
TV80	€ 37,50	1	024000403

T83

24



- 920A 10-11-12-13-14 - 15-16-17-18-19 - 20-21-22-23-24 - 26-27-30-32 mm
- 920/21 125 mm
- 920/22 255 mm
- 920/25
- 920/42 305 mm
- 920/55

3,6 kg

12"



T83	€ 338,00	1	024240083
TV83	€ 37,50	1	024000402



T85



- 861LP 0,5x3 - 0,6x4,5 - 0,8x5,5 - 1x5,5 - 1,2x6,5 - 1,2x8 - 1,6x8 mm
- 861PE 2 - 2,5 - 3 - 4 - 5 - 6 - 8 - 10 mm
- ⊕ 861PH PH0 - PH1 - PH2 - PH3
- ⊕ 861PZ PZ1 - PZ2 - PZ3
- ⊕ 861TX T6 - T7 - T8 - T9 - T10 - T15 - T20 - T25 - T27 - T30 - T40
- ⊕ 861RTX T9 - T10 - T15 - T20 - T25 - T27 - T30 - T40
- ⊕ 861TRW 1-2-3-4-5-6 mm
- ⊕ 861TQS 0 - 1 - 2 - 3 - 4 - 5 - 6 - 8 - 10 mm
- 861SP 4-6-8-10-12 mm
- 851SR 230 mm
- 900 4-4,5-5,5-5,5-6-7-8-9 - 10-11-12-13-14 mm
- 900/21 150 mm
- 900/25 41 mm
- 900BG/30 176 mm
- 900/42 115 mm
- ⊕ 900/55 125 mm
- 194 1/4x5/16

1,0 kg

14"



T85	391,00	1	024240085
TV85	37,50	1	024000747

T91



- 900 4-4,5-5,5-5,6 - 7-8-9-10-11 - 12-13-14 mm
- 900ME 2,5-3-4-5-6-8 mm
- 900/20 50 mm
- 900/21 150 mm
- 900/25 41 mm
- 900BG/30 176 mm
- 900/42 115 mm
- ⊕ 900/55 125 mm

560 g

14"



T91	249,50	1	024240091
TV90	28,50	1	024000447

T92



- 910A 6-7-8-9-10-11-12-13 - 14-15-16-17-18-19 - 20-21-22 mm
- 910/21 125 mm
- 910/22 250 mm
- 910/25 41 mm
- 910/42 210 mm
- ⊕ 910/55 125 mm

1,5 kg

38"



T92	274,00	1	024240092
TV92	28,50	1	024000458

T99



- 920INOX-A 10-12-13-14-15-16-17 - 18-19-21-22-24-27 - 30-32mm
- ⊕ 920/55INOX



2,7 kg

12"



T99	1.295,00	1	024240099
TV99	28,50	1	024249908

T100



- 920A 10-12-13-14-15 - 16-17-18-19-21 - 22-24 mm
- 920/21 125 mm
- 920/25 41 mm
- 920/42 305 mm
- ⊕ 920/55 125 mm

2,1 kg

12"



T100	244,00	1	024240100
TV100	28,50	1	024000495

T101



- 920B 10-12-13-14-15 - 16-17-18-19-21 - 22-24 mm
- 920/21 125 mm
- 920/25 41 mm
- 920/42 305 mm
- ⊕ 920/55 125 mm

2,1 kg

12"



T101	244,00	1	024240101
TV100	28,50	1	024000495

T102



- 920AS 3/8-7/16-1/2 - 9/16-5/8-11/16 - 3/4-13/16-7/8 - 15/16-1-1.1/16
- 920/21 125 mm
- 920/25 41 mm
- 920/42 305 mm
- ⊕ 920/55 125 mm

2,1 kg

12"



T102	263,00	1	024240102
TV100	28,50	1	024000495

T103



- 900L 6-7-8-9-10-11-12 mm
- 920AL 13-14-16-17-18-19 - 21-22-24-27 mm

1,1 kg

14" 12"



T103	312,00	1	024240103
TV103	28,50	1	024000748

T105



- 928A 22-24-27-30-32-34 - 36-38-41-46-50 mm

4,9 kg

34"



T105	333,00	1	024240105
TV105	31,50	1	024000484

T106



- 928/21 200 mm
- 928/22 380 mm
- 928/42 450 mm
- 928/55 125 mm

4,5 kg

34"



T106	361,00	1	024240106
TV106	31,50	1	024000485

T111



- 720 10-13-15-17-18-19-21 - 22-24-27-30-32 mm
- 720LC 17-19-21 mm
- 720/21 125 mm

2,7 kg

12"



T111	286,00	1	024240111
TV111	28,50	1	024000476

T112

32



- 861TX ● 1/4-T6+T15
- 866TX ● 5/16-T20+T55
- 895/1 ○ 1/4x□1/4
- 895/6 ○ 5/16x□1/2
- 900FTX □ 1/4-E4+E10
- 920FTX □ 1/2-E12+E24
- 920TX □ 1/2-T55L-T60-T70L

1,3 kg

14" 12"



T112	€ 341,00	1	024240112
TV112	€ 28,50	1	024000480

T113

12



- 920PE 5L-6L-7L-8L-10L
- 920TX T40L-T45L
T55L-T70L
- 920XZN M6L-M8L-M12L

1,5 kg

12"



T113	€ 299,00	1	024240113
TV113	€ 28,50	1	024000489

T122

1



666/20 40 - 200 Nm

1,2 kg

12"



T122	€ 288,00	1	024240122
TV122	€ 31,50	1	024000768

T123

3



- 1082G 160 mm
- 1150G 180 mm
- 1166G 160 mm

550 g



T123	€ 88,00	1	024240123
TV135	€ 28,50	1	024000762

T124

3



- 1082GBM 160 mm
- 1150GBM 180 mm
- 1166GBM 160 mm

640 g



T124	€ 111,00	1	024240124
TV135	€ 28,50	1	024000762

T135

3



- 1082MQ 160 mm
- 1150MQ 180 mm
- 1166MQ 160 mm

△ 1000 V

750 g



T135	€ 139,00	1	024240135
TV135	€ 28,50	1	024000762

T136

2



- 1048MQ 250 mm
- 1777MQ/U

△ 1000 V

700 g



T136	€ 115,50	1	024240136
TV136	€ 28,50	1	024000438

T137

3



- 1084BM 160 mm
- 1150BM 180 mm
- 1166BM 160 mm

750 g



T137	€ 128,00	1	024240137
TV130	€ 28,50	1	024000451

T138

3



- 1084 160 mm
- 1150 180 mm
- 1166 160 mm

650 g



T138	€ 104,50	1	024240138
TV130	€ 28,50	1	024000451

T140

8



- 1032 140x0,9 - 180 mm
- 1034 170 mm
- 1036 140x1,3 - 175 mm
- 1038 175 mm
- 1084 160 mm
- 1128BM

1,1 kg



T140	€ 248,50	1	024240140
TV140	€ 37,50	1	024000405

T144

4



- 1048N 250 mm
- 1052 240 mm
- 1112 250 mm
- 1150 180 mm

1,8 kg



T144	€ 152,00	1	024240144
TV143	€ 37,50	1	024000409

T145

4



- 1032 180 mm
- 1034 170 mm
- 1036 175 mm
- 1038 175 mm

640 g



T145	€ 134,50	1	024240145
TV145	€ 28,50	1	024000448

T146



- 1032 140x0,9 mm
- 1032 225 mm
- 1036 140x1,3 mm
- 1036 225 mm

700 g



T146	140,00	1	024240146
TV146	28,50	1	024000449

T151



- 1047 240 mm
- 1057A 240 mm

1,3 kg



T151	126,00	1	024240151
TV150	28,50	1	024000462

T153



- 1048N 250 mm
- 1052 240 mm

1,1 kg



T153	83,00	1	024240153
TV150	28,50	1	024000462

T156



- ◁ 1082 160 mm
- ≡ 1150 180 mm
- 1048N 250 mm

1 kg



T156	107,00	1	024240156
TV148	28,50	1	024000500

T157



- ◁ 1082BM 160 mm
- ≡ 1150BM 180 mm
- 1048BM 250 mm

1,1 kg



T157	139,50	1	024240157
TV148	28,50	1	024000500

T160



- 1290 3x75
3x100
4x100
4x150
5,5x100
5,5x150
6,5x150
8x150
10x200 mm
- 1290N 4x30
6,5x30 mm

1,3 kg



T160	149,50	1	024240160
TV160	37,50	1	024000706

T161



- 1292 PH0x60
PH0x100
PH1x80
PH1x120
PH2x100
PH2x150
PH3x150 mm
- 1292N PH1x30
PH2x30 mm

1 kg



T161	116,50	1	024240161
TV161	37,50	1	024000707

T164



- 952 8-10-13-17-19 mm
- 959 16 mm (5/8") - 20,8 mm (13/16")
- 1260 3x75 - 4x100 - 5,5x100 - 6,5x150 - 10x200 mm
- 1262 PH0x60 - PH1x80 - PH2x100 - PH3x150 mm

5 kg



T164	528,00	1	024240164
TV61	59,00	1	024000721

T167



- 1260 3x75
3x100
4x100
4x150
5,5x100
5,5x150
6,5x150
8x150
10x200 mm
- 1260N 4x30
6,5x30 mm

1,3 kg



T167	117,50	1	024240167
TV160	37,50	1	024000706

T168



- 1262 PH0x60
PH0x100
PH1x80
PH1x120
PH2x100
PH2x150
PH3x150 mm
- 1262N PH1x30
PH2x30 mm

1 kg



T168	94,50	1	024240168
TV161	37,50	1	024000707

T170



- 1290 2,5x50
3x75
3,5x100
4x125
5,5x100
5,5x150
6,5x150 mm

450 g



T170	81,00	1	024240170
TV170	28,50	1	024000741

T171



- 1290 8x150
8x200
10x200 mm
- 1290N 4x30
6,5x30 mm

750 g



T171	88,50	1	024240171
TV171	28,50	1	024000742

T172**Betamax**

- 1292 PH0x60
PH0x100
PH1x80
PH1x120
PH2x100
PH2x150 mm

450 g



T172	€ 73,00	1	024240172
TV172	€ 28,50	1	024000743

T173**Betamax**

- 1292 PH3x150
PH4x200 mm
- 1292N PH1x30
PH2x30 mm

560 g



T173	€ 73,00	1	024240173
TV173	€ 28,50	1	024000744

T175**Betamax**

- 1297TX T6-T7-T8-T9
T10-T15-T20

410 g



T175	€ 116,50	1	024240175
TV175	€ 28,50	1	024000760

T176**Betamax**

- 1297TX T25-T27-T30
T40-T45

640 g



T176	€ 108,00	1	024240176
TV176	€ 28,50	1	024000761

T177**Betamax**

- 1298RTX T9-T10-T15
T20-T25-T27
T30-T40

680 g



T177	€ 163,00	1	024240177
TV177	€ 28,50	1	024000759

T180**Betamax**

- 1290 3x75
4x100
5,5x150
6,5x150 mm
- 1292 PH0x60
PH1x80
PH2x100 mm

480 g



T180	€ 84,00	1	024240180
TV180	€ 28,50	1	024000701

T183**Betamax**

- 1292L PH1x400-PH2x400 mm
- 1294L 3x300-4x400-5x400 mm

580 g



T183	€ 116,00	1	024240183
TV183	€ 31,50	1	024000497

T198

- 1260 3x75
4x100
5,5x150
6,5x150 mm
- 1269PZ PZ0 - PZ1 - PZ2

490 g



T198	€ 70,50	1	024240198
TV180	€ 28,50	1	024000701

T199

- 1260 2,5x50
3x75
3,5x100
4x125
5,5x100
5,5x150
6,5x150 mm

490 g



T199	€ 63,00	1	024240199
TV170	€ 28,50	1	024000741

T201

- 1260 8x200
10x150
10x200 mm
- 1260N 4x30
6,5x30 mm

680 g



T201	€ 68,50	1	024240201
TV171	€ 28,50	1	024000742

T202

- 1262 PH0x60
PH0x100
PH1x80
PH1x120
PH2x100
PH2x150 mm

490 g



T202	€ 59,00	1	024240202
TV172	€ 28,50	1	024000743

T204

- 1262 PH3x150
PH4x200 mm
- 1262N PH1x30
PH2x30 mm

610 g



T204	€ 56,00	1	024240204
TV173	€ 28,50	1	024000744

T205



1267TX T6-T7-T8-T9
T10-T15-T20

460 g



T205	83,50	1	024240205
TV175	28,50	1	024000760

T206



1267TX T25-T27-T30
T40-T45

710 g



T206	86,50	1	024240206
TV176	28,50	1	024000761

T207



1268RTX T9-T10-T15
T20-T25-T27-T30

760 g



T207	104,00	1	024240207
TV207	28,50	1	024000758

T208



1260 3x75
4x100
5,5x150
6,5x150 mm
1262 PH0x60
PH1x80
PH2x100 mm

530 g



T208	67,00	1	024240208
TV180	28,50	1	024000701

T209



1262L PH1x400-PH2x400 mm
1264L 3x300 - 4x400 - 5x400 mm

580 g



T209	83,00	1	024240209
TV183	31,50	1	024000497

T211



1201E 2,5x50
3x75
3,5x100
4x125
5,5x100
5,5x150
6,5x150 mm

490 g



T211	45,00	1	024240211
TV170	28,50	1	024000741

T213



1202E PH0x60
PH1x80
PH1x120
PH2x100
PH2x150
PH3x150 mm

490 g



T213	48,50	1	024240213
TV212	28,50	1	024000440

T216



1207E/TX T6-T7-T8-T9
T10-T15-T20

410 g



T216	64,00	1	024240216
TV175	28,50	1	024000760

T221



1201E 3x75
4x100
5,5x150
6,5x150 mm
1202E PH0x60
PH1x80
PH2x100 mm

530 g



T221	47,50	1	024240221
TV180	28,50	1	024000701

T226



1274MQ 3x100
4x100
5,5x125
6,5x150 mm
1272MQ PH0x60
PH1x80
PH2x100 mm

1000 V

460 g



T226	98,00	1	024240226
TV180	28,50	1	024000701

T227



944BX 5-6-7-8-10-13 mm

490 g



T227	150,50	1	024240227
TV227	28,50	1	024000705

T228



1290INOX 3x75 - 4x100 -
5,5x150 - 6,5x150 mm
1292INOX PH0x60
- PH1x80 - PH2x100
mm



480 g



T228	97,00	1	024240228
TV180	28,50	1	024000701

T231



- 1370 400 g
- 1390 Ø 35 mm
- ▲ 1719BMA/T 200 mm
- ▮ 1719BMA/P 200 mm
- ▶ 1719BMA/M 200 mm

1,7 kg



T231	€ 129,50	1	024240231
TV230	€ 37,50	1	024000411

T233



- 35 100-200 mm
- 1370F 32 mm
- 1390 Ø 35 mm

1,3 kg



T233	€ 120,50	1	024240233
TV232	€ 28,50	1	024000452

T234



- 35 100-200 mm
- 1370 300 g
- 1390 Ø 35 mm

1,3 kg



T234	€ 109,50	1	024240234
TV232	€ 28,50	1	024000452

T236



- 1719BMA/Q 200 mm
- ▲ 1719BMA/T 200 mm
- ▮ 1719BMA/P 200 mm
- ▶ 1719BMA/M 200 mm
- 1719BMA/R 200 mm

870 g



T236	€ 101,50	1	024240236
TV235	€ 28,50	1	024000453

T239



- 31BM Ø 2-3-4-5-6-8 mm
- 32 Ø 4 mm

850 g



T239	€ 140,00	1	024240239
TV239	€ 28,50	1	024000439

T241



- 1500N/1
- 1500N/3
- 1516/1

4,2 kg



T241	€ 339,00	1	024240241
TV241	€ 37,50	1	024000414

T259



- 96BP 2,5-3-4-5
6-8-10 mm
- 96N 12 mm
- 860MIX/A31
-
-
-
-
- 895/1

950 g



T259	€ 170,00	1	024240259
TV263	€ 28,50	1	024000492

T264



- 1491 Ø 65+110 mm
- 1494 10 mm
- 1494E Ø 8-9-10-11-12-14-17 mm
- 1494Q Ø 8-9,5-12-13 mm
- △ 1494T Δ 9,5
- 1494XZN Ø 16
- 1496C ■ 8x ■ 10 mm

2,1 kg



T264	€ 244,00	1	024240264
TV264	€ 28,50	1	024000466

T270



- 430 M3-4-5-6-7-8-9
10-12-14-16-18-20
- 433 M6x0,75-M8x1-M10x1,25
M12x1,5-M14x1,5
M16x1,5-M18x1,5
- 440 M3-4-5-6-7-8-9
- 440A M10-12-14-16-18-20
- 441 M6x0,75-M8x1,0
- 441A M10x1,25-M12x1,5
M14x1,5-M16x1,5
M18x1,5

4,3 kg



T270	€ 586,00	1	024240270
TV270	€ 37,50	1	024000481

T273



- 435/1,5 M3=M12
- 435/3 M5=M21
- 436/1 □ 2,0+5,0 mm
(M3=M8)
- 436/2 □ 4,6+8 mm
(M5=M12)
- 444/1 Ø 25,4 mm
- 444/2 Ø 38,1 mm
- 1707 W 62+4x1"

2,1 kg



T273	€ 268,00	1	024240273
TV272	€ 37,50	1	024000482

T281



- 1741B 250 mm
- 1741RV2,9K 2,9x6 mm (100)
- 1741RV3,2K 3,2x8 mm (100)
- 1741RV3,8K 3,8x10 mm (100)
- 1741RV4K 4x12 mm (100)

1,4 kg



T281	€ 88,50	1	024240281
TV280	€ 28,50	1	024000478

Beta
Quality Tools

T279



1112	250 mm
1128BM	
1726	400 mm
1728BM	(x5)
1751N	200 cc

1,5 kg



T279	€ 149,00	1	024240279
TV285	€ 46,00	1	024000487

T284



1128BMX	
1130BMX	
■ 1719BMA...Q	200 mm
▲ 1719BMA...T	200 mm
■ 1719BMA...P	200 mm
▶ 1719BMA...M	200 mm
● 1719BMA...R	200 mm
1726BM	400 mm
1728BM	
1771BM	170 mm
1778V18	185 mm

3,3 kg



T284	€ 290,00	1	024240284
TV286	€ 59,00	1	024249904



T291



1479RB/1
1479RB/2
1479RB/3

600 g



T291	€ 113,00	1	024240291
TV291	€ 28,50	1	024000472

T294



1692	5 m
1725CR	
1771RL	
1771	

590 g



T294	€ 81,50	1	024240294
TV294	€ 28,50	1	024000491

T297



1651DGTB
1682
1691BM

490 g



T297	€ 164,50	1	024240297
TV296	€ 28,50	1	024000749

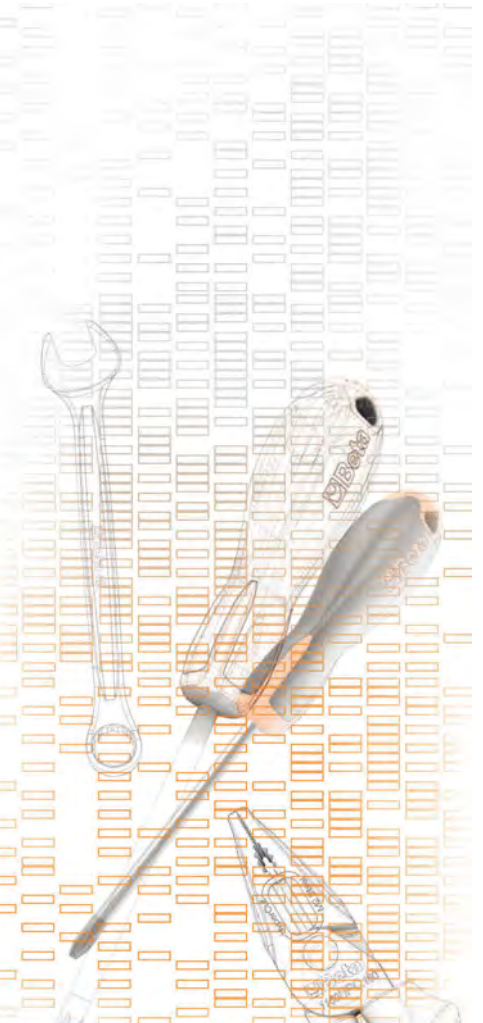

VP1-VP2

Voorgevormde kunststof inzetbakken voor kleine delen voor alle modellen gereedschapskisten: RSC22, RSC23, RSC23C

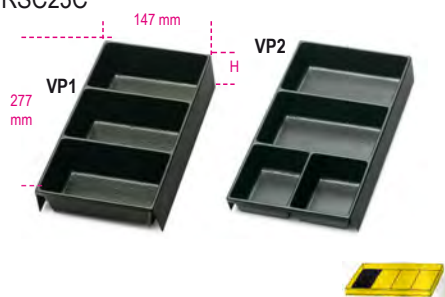

	H mm	€	1	088880351
VP1	50	18,10	1	088880351
VP2	35	18,10	1	088880352

VP3-VP4

Voorgevormde kunststof inzetbakken voor kleine delen voor alle modellen gereedschapskisten en voor de gereedschapswagens

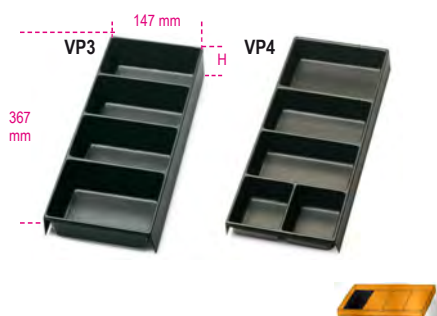

	H mm	€	1	088880353
VP3	50	18,80	1	088880353
VP4	35	18,80	1	088880354

VP5

Voorgevormde kunststof inzetbakken



	€	1	088880355
VP5	21,40	1	088880355

VP6

Voorgevormde kunststof inzetbakken



	€	1	088880359
VP6	21,20	1	088880359

VP-3SC

Inzetbakken, vervaardigd uit kunststof, voor gereedschapswagen C38 +C04TSS-7

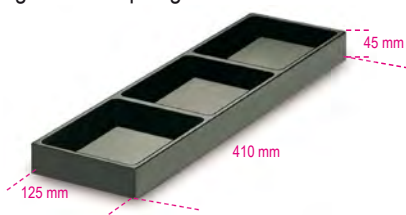

	H mm	€	1	088880356
VP-3SC	45	21,90	1	088880356

VP-LS

Inzetbakken, vervaardigd uit kunststof, voor gereedschapswagen C38 +C04TSS-7



	H mm	€	1	088880357
VP-LS	45	14,50	1	088880357

VP-LD

Inzetbakken, vervaardigd uit kunststof, voor gereedschapswagen C38



	H mm	€	1	088880358
VP-LD	45	13,80	1	088880358

8889P1

Lengte vakverdeling voor artikel RSC22, RSC23, RSC23C en C27S
Lade afmeting 588x277 mm

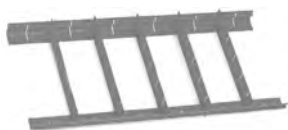

	h mm	€	1	088890005
8889P1/5	50 mm	57,50	1	088890005
8889P1/7	70 mm	58,00	1	088890007

8889C1

Vakverdeling voor artikel RSC22, RSC23, RSC23C en C27S
Voor lade afmeting 588x277 mm

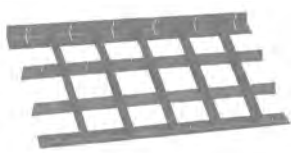

	h mm	€	1	088890015
8889C1/5	50 mm	76,50	1	088890015
8889C1/7	70 mm	77,00	1	088890017

8889P2

Lengte vakverdeling voor standaard lade 588x367 mm

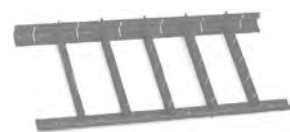

	h mm	€	1	088890107
8889P2/7	70 mm	67,00	1	088890107

8889C2

Vakverdeling voor standaard lade 588x367 mm

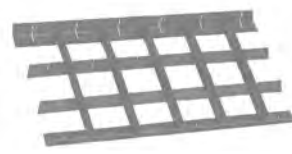

	h mm	€	1	088890117
8889C2/7	70 mm	86,00	1	088890117

8889P3

Lengte vakverdeling voor artikel RSC24AXL

Voor lade afmeting 882x367 mm



	h mm	€	1	088890207
8889P3/7	70 mm	107,00	1	088890207

8889C3

Vakverdeling voor artikel RSC24AXL

Voor lade afmeting 882x367 mm

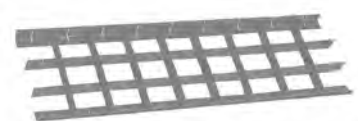

	h mm	€	1	088890217
8889C3/7	70 mm	131,00	1	088890217

8889P4

Lengte verdeling voor artikel C41

Voor lade afmeting 418x205 mm



	h mm	€	1	088890307
8889P4/7	70 mm	45,50	1	088890307

8889I4

Vakverdeling voor trolley C41

Voor lade afmeting 418x205 mm



	h mm	€	1	088890317
8889C4/7	70 mm	55,00	1	088890317

8889PS

Lengte verdeling voor artikel C38 - C45PRO
M4/M5/M7/M8

Lade aan linkerkzijde afmeting 570x410 mm



8889PS/7 h 70 mm € 80,50 1 088890407

8889CS

Vakverdeling voor artikel C38 - C45PRO M4/
M5/M7/M8

Voor lade aan linkerkzijde afmeting 570x410 mm

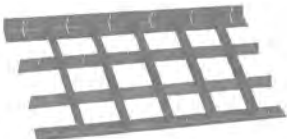

8889CS/7 h 70 mm € 98,50 1 088890417

8889PD

Lengte verdeling voor artikel C38

Lade aan rechterzijde afmeting 313x410 mm



8889PD/7 h 70 mm € 42,50 1 088890427

8889CD

Vakverdeling voor artikel C38

Voor lade aan rechterzijde afmeting 313x410 mm



8889CD/7 h 70 mm € 58,50 1 088890437

8889C6

Vakverdeling voor artikel C35

Voor lade afmeting 600x447 mm



8889C6/7,5 h 75 mm € 41,00 1 088890475
8889C6/10 h 100 mm € 39,50 1 088890480
8889C6/15 h 150 mm € 51,00 1 088890485
8889C6/20 h 200 mm € 78,00 1 088890490

SB

Dophouder rail



	L mm	€		
SB1	210	4,80	10	088880201
SB2	280	5,25	10	088880202
SB3	360	5,80	10	088880203

PM 1/2-Q5

Magnetische dopsleutel houder



PM 1/2-Q5 € 50,00 1 088880233

MB

Dopsleutelklemmen
voor SB dophouder rail



	□	€		
MB0	1/4	1,30	50	088880210
MB1	3/8	1,30	50	088880211
MB2	1/2	1,30	50	088880212

KIT/GPS

Set bestaande uit 40mm haak GPS en
borgschroef VE1

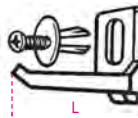

KIT/GPS-40 mm	€ 3,25	50	088880119
KIT/GPS-90 mm	€ 3,50	50	088880117

VE1

Bevestigingsschroef



VE1 € 0,99 20 088880120

GM

klemhaken met schroef



∅ mm	€		
6,5	7,65	5	088880250
9,5	7,90	5	088880251
13	7,90	5	088880252
16	9,30	5	088880253
19	9,60	5	088880254
25	9,60	5	088880255

S55/8

Wandhouder voor 8 dubbele steeksleutels,
gemaakt van plaatstaal

• compleet geleverd met 3 bevestigingsschroeven VE1

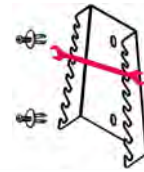

S55/8 € 27,50 1 088880420
55/S8
55AS/8
55MP/S8

S55/12

Wandhouder voor 12 dubbele steeksleutels,
gemaakt van plaatstaal

• compleet geleverd met 3 bevestigingsschroeven VE1

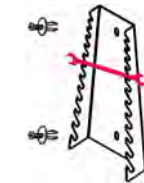

S55/12 € 36,00 1 088880421
55/S12
55/S12X
55AS/12
55MP/S12

ST2P

wandhouder voor tangen, gemaakt van
plaatstaal

• compleet geleverd met 3 bevestigingsschroeven VE1

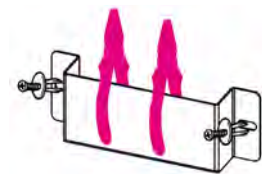

ST2P € 30,00 1 088880422

TSPP

gereedschapshouders, gemaakt van kunststof

• compleet geleverd met 3 bevestigingsschroeven VE1



TSPP € 7,95 1 088880402

S952/10

Wandhouder voor 10 T-cardansleutels,
gemaakt van plaatstaal

• compleet geleverd met 3 bevestigingsschroeven VE1



S952/10 € 37,00 1 088880423

S1719BM

Wandhouder voor 5 vijlen, gemaakt van plaatstaal

• compleet geleverd met 3 bevestigingsschroeven VE1



S1719BM	€	1	088880404
1719BMA: Q-T-P-M-R	20,50		
1719BMD: Q-T-P-M-R			
1719BMX: Q-T-P-M-R			

SGN

Wandhouder voor 2 stubby schoevendraaiers, gemaakt van plaatstaal

• compleet geleverd met 3 bevestigingsschroeven VE1

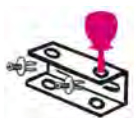

SGN	€	1	088880405
1290N-1292N-1299N/PZ	10,70		
1260N-1262N-1269N/PZ			
1201EN-1202EN-1209EN/PZ			

CB/2

harde thermogevormde bak voor 1/2" doppen en toebehoren, leeg

• alleen voor item C54S

12"



CB/2	€	1	088880411
920A/920B	31,50		
10÷24+26-27			
28-30-32 mm			
920/21-920/22-920/25-			
920/42-920/55			

S42/17

wandhouder voor 17 ringsteeksleutels, gemaakt van plaatstaal

• compleet geleverd met 3 bevestigingsschroeven VE1



S42/17	€	1	088880428
42/S17	36,00		
42MP/S17			
42/S17X			
42AS/17			
142/S17			

S951/6

Wandhouder voor 6 T-sleutels met zeskantstiften, gemaakt van plaatstaal

• compleet geleverd met 3 bevestigingsschroeven VE1

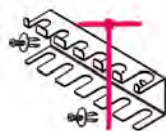

S951/6	€	1	088880429
951/S6	22,60		
951AS/S6X			
951TX/S6			

SPG11 - S1203/8

Wandhouder voor schroevendraaiers, gemaakt van plaatstaal

• compleet geleverd met 3 bevestigingsschroeven VE1



SPG11	€	1	088880910
n.8 Ø = 7 mm	26,00		
n.2 Ø = 10 mm			
n.1 Ø = 12 mm			
S1203/8	€	1	088880430
1203E/S8	26,50		
1263/D8			
1293/S8			

S96T/8

wandhouder voor 8 T-inbussleutels, gemaakt van plaatstaal

• compleet geleverd met 3 bevestigingsschroeven VE1



S96T/8	€	1	088880431
96T/AS8	27,00		
96T/S8			
97TTX/S8			

96T/SPV

Wandhouder voor T-inbussleutels, gemaakt van plaatstaal

• compleet geleverd met 3 bevestigingsschroeven VE1

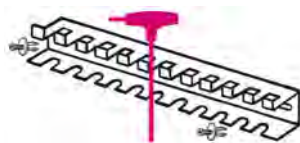

96T/SPV	€	1	000960958
96T/S11	35,00		
97TTX/S11			

Beta



Beta CHEMICALS

Het aandraaien van een bout is niet altijd voldoende om een veilige bevestiging te garanderen. Reiniging, smering en afdichting zijn ook noodzakelijk. Het assortiment omvat anaërobe afdichtingsmiddelen, cyanoacrylaatlijmen en spuitbussen voor het onderhouden, reinigen en smeren van mechanische onderdelen.

Anaërobieproducten

Anaërobie producten maken het volledig vullen van kleine oppervlakkige onregelmatigheden in metaal mogelijk, zodat mechanische spanning over het verbindingsoppervlak kan worden verdeeld. Ze harden uit in totale afwezigheid van zuurstof en sluiten gewrichten of draden volledig af van water, gas, olie, brandstof en industriële vloeistoffen.

Ze zijn verkrijgbaar in drie verschillende sterktes - hoog (H), medium (M) en laag (L) - en in verschillende verpakkingen, om aan verschillende behoeften te voldoen.

Siliconenkit

Siliconenkitten maken een permanente elastische afdichting mogelijk, waardoor wordt voorkomen dat kleine stoffen in de voeg terechtkomen (puin, stof...) en voorgevormde pakkingen worden vervangen. Op basis van hun elastische capaciteit kunnen ze beweging absorberen, zonder te worden beïnvloed door inwendige uitzetting of breuk. Siliconenkitten polymeriseren door te reageren met atmosferisch vocht en vormen elastische, duurzame pakkingen.

Het product wordt geleverd via een handige dispenser (drukverpakking), waardoor het werk vereenvoudigd wordt. Het kan ook met één hand worden gebruikt en zorgt voor een nauwkeurige en uniforme verspreiding.

Contact Lijm

Adhesive based on ethyl cyanoacrylate, for structural joints in a number of materials.

Spuitbussen

Een breed scala aan producten in spuitbussen, voor gebruik voor het losmaken, smeren, olien, reinigen, verzinken en ontsmetten.

Vloeistoffen

Ontwikkeld om aanslag en roest van mechanische onderdelen en metalen voorwerpen te verwijderen. Ideaal voor gebruik met ultrasone reinigings apparaten uit de serie 1895.



ATTENTIE Landen waar de producten van het Beta Chemicals-assortiment mogen worden gedistribueerd: Oostenrijk, Andorra, België, Tsjechië, Dominicaanse Republiek, Frankrijk, Hongarije, Italië, Nederland, Nieuw-Caledonië, Volksrepubliek China, Polen, Portugal, Vorstendom Monaco, Republiek Ierland, Reunion, San Marino, Slowakije, Slovenië, Spanje, Zwitserland, Verenigde Arabische Emiraten, Verenigd Koninkrijk.

9803H

Schroefdraad borgmiddel - Grote sterkte

ideaal voor permanente borging, ideaal voor delen die niet ontmanteld hoeven te worden en voor vlakke metalen oppervlakten, waaronder koper, aluminium en roestvast staal. Niet mogelijk te demonteren met handgereedschap.



Temperatuur bereik (°C)	-50/+150
Max. afdichtingsvlak (mm)	0,25
Verwerkingstijd (minuten)	10/15
Uithardingstijd	3-6
Viscositeit (mPa.s) 25°C	800/1200
Losbreek sterkte ISO-10964	35-45 Nm
Functionele sterkte ISO-10964	30-40 Nm

ml	€		
20	12,00	12	098030002
50	18,70	4	098030005
250	48,00	4	098030025
20		12	098032002
50		4	098032005
250		4	098032025

9802M

Schroefdraad borgmiddel - Gemiddelde sterkte

ideaal voor delen welke onderhevig zijn aan periodiek onderhoud. Demontage met alleen handgereedschap is mogelijk.



Temperatuur bereik (°C)	-50/+150
Max. afdichtingsvlak (mm)	0,15
Verwerkingstijd (minuten)	10/15
Uithardingstijd	3-6
Viscositeit (mPa.s) 25°C	500/800
Losbreek sterkte ISO-10964	22-30 Nm
Functionele sterkte ISO-10964	20-25 Nm

ml	€		
20	12,00	12	098020002
50	18,70	4	098020005
250	48,00	4	098020025
20		12	098022002
50		4	098022005
250		4	098022025

9801L

Schroefdraad borgmiddel - Lage sterkte

ideaal voor bepaalde lichte legeringen welke beschadigt kunnen worden tijdens het demonteren en voor stelschroeven. Eenvoudiger delen te dementeren.



Temperatuur bereik (°C)	-50/+150
Max. afdichtingsvlak (mm)	0,10
Verwerkingstijd (minuten)	10/15
Uithardingstijd	3-6
Viscositeit (mPa.s) 25°C	500/800
Losbreek sterkte ISO-10964	6-10 Nm
Functionele sterkte ISO-10964	4-8 Nm

ml	€		
20	12,00	12	098010002
50	18,70	4	098010005
250	48,00	4	098010025
20		12	098012002
50		4	098012005
250		4	098012025

9813H

Schroefdraad afdichting - Grote sterkte

ideaal voor afdichten van oppervlakten en verbindingen delen die niet ontmanteld hoeven te worden en voor vlakke metalen oppervlakten, waaronder koper, aluminium en roestvast staal. Niet mogelijk te demonteren met handgereedschap.



Temperatuur bereik (°C)	-50/+200
Max. afdichtingsvlak (mm)	0,15
Verwerkingstijd (minuten)	10/15
Uithardingstijd	3-6
Viscositeit (mPa.s) 25°C	40.000/80.000
Losbreek sterkte ISO-10964	35-45 Nm
Functionele sterkte ISO-10964	25-35 Nm

ml	€		
20	11,60	12	098130002
50	20,40	6	098130305
50	19,50	4	098130505
250	47,00	4	098130525
20		12	098132002
50		6	098132305
50		4	098132505
250		4	098132525

9812M

Schroefdraad afdichting - Gemiddelde sterkte

ideaal voor afdichten van oppervlakten en verbindingen delen welke onderhevig zijn aan periodiek onderhoud. Demontage met alleen handgereedschap is mogelijk.



Temperatuur bereik (°C)	-50/+150
Max. afdichtingsvlak (mm)	0,35
Verwerkingstijd (minuten)	12/18
Uithardingstijd	3-6
Viscositeit (mPa.s) 25°C	20.000/40.000
Losbreek sterkte ISO-10964	27-35 Nm
Functionele sterkte ISO-10964	20-30 Nm

ml	€		
20	11,60	12	098120002
50	20,40	6	098120305
50	19,50	4	098120505
250	47,00	4	098120525
20		12	098122002
50		6	098122305
50		4	098122505
250		4	098122525

9811L

Schroefdraad afdichting - Lage sterkte

ideaal voor remmen kleine of fijne draad. Eenvoudiger delen te dementeren.



Temperatuur bereik (°C)	-50/+150
Max. afdichtingsvlak (mm)	0,20
Verwerkingstijd (minuten)	10/15
Uithardingstijd	3-6
Viscositeit (mPa.s) 25°C	10.000/20.000
Losbreek sterkte ISO-10964	6-10 Nm
Functionele sterkte ISO-10964	4-8 Nm

ml	€		
20	11,60	12	098110002
50	20,30	6	098110305
50	19,50	4	098110505
250	47,00	4	098110525
20		12	098112002
50		6	098112305
50		4	098112505
250		4	098112525

9823H

Vloeibare pakking - Grote sterkte

Ideaal voor permanente toepassing. Eveneens ideaal voor het opvullen van lagerbehuizing of versleten delen. Niet mogelijk te demonteren met handgereedschap.



Temperatuur bereik (°C)	-50/+150
Max. afdichtingsvlak (mm)	0,35
Verwerkingstijd (minuten)	10/16
Uithardingstijd	3-6
Viscositeit (mPa.s) 25°C	100.000/200.000
Losbreek sterkte ISO-10964	35-45 Nm
Functionele sterkte ISO-10964	20-30 Nm

ml	€	🔧	📦
20	11,60	12	098230002
50	20,40	6	098230305
50	19,50	4	098230505
250	47,00	4	098230525
20		12	098232002
50		6	098232305
50		4	098232505
250		4	098232525

9822M

Vloeibare pakking - Gemiddelde sterkte

Ideaal voor het beschermen van oppervlakten delen welke onderhevig zijn aan periodiek onderhoud. Demontage met alleen handgereedschap is mogelijk.



Temperatuur bereik (°C)	-50/+150
Max. afdichtingsvlak (mm)	0,35
Verwerkingstijd (minuten)	10/15
Uithardingstijd	3-6
Viscositeit (mPa.s) 25°C	40.000/70.000
Losbreek sterkte ISO-10964	25-35 Nm
Functionele sterkte ISO-10964	20-30 Nm

ml	€	🔧	📦
20	11,60	12	098220002
50	20,40	6	098220305
50	19,50	4	098220505
250	47,00	4	098220525
20		12	098222002
50		6	098222305
50		4	098222505
250		4	098222525

9821L

Vloeibare pakking - Lage sterkte

Ideaal voor het beschermen van oppervlakten delen welke onderhevig zijn aan regelmatig onderhoud. Verdraagt lichte vervuiling door olie. Bescherm het schroefdraad tegen corrosie en vastroesten. Eenvoudiger delen te dementeren.



Temperatuur bereik (°C)	-50/+150
Max. afdichtingsvlak (mm)	0,35
Verwerkingstijd (minuten)	20/30
Uithardingstijd	3-6
Viscositeit (mPa.s) 25°C	60.000/90.000
Losbreek sterkte ISO-10964	7-11 Nm
Functionele sterkte ISO-10964	4-9 Nm

ml	€	🔧	📦
20	11,60	12	098210002
50	20,40	6	098210305
50	19,50	4	098210505
250	47,00	4	098210525
20		12	098212002
50		6	098212305
50		4	098212505
250		4	098212525

9833H

Vlakafdichting - Grote sterkte

Ideaal voor monteren delen welke niet ontmanteld dienen te worden
Geschikt om reeds gemonteerde apparaten, welke moeilijk te demonteren zijn, alsnog te borgen. Niet mogelijk te demonteren met handgereedschap.



Temperatuur bereik (°C)	-50/+180
Max. afdichtingsvlak (mm)	0,15
Verwerkingstijd (minuten)	10/15
Uithardingstijd	3-6
Viscositeit (mPa.s) 25°C	400/700
Losbreek sterkte ISO-10964	35-45 Nm
Functionele sterkte ISO-10964	30-40 Nm

ml	€	🔧	📦
20	11,80	12	098330002
50	18,50	4	098330005
250	48,00	4	098330025
20		12	098332002
50		4	098332005
250		4	098332025

9832M

Vlakafdichting - Gemiddelde sterkte

Ideaal voor monteren delen welke onderhevig zijn aan periodiek onderhoud.
Demontage met alleen handgereedschap is mogelijk.



Temperatuur bereik (°C)	-50/+180
Max. afdichtingsvlak (mm)	0,25
Verwerkingstijd (minuten)	12/20
Uithardingstijd	3-6
Viscositeit (mPa.s) 25°C	2000/4000
Losbreek sterkte ISO-10964	25-35 Nm
Functionele sterkte ISO-10964	18-28 Nm

ml	€	🔧	📦
20	11,80	12	098320002
50	18,50	4	098320005
250	48,00	4	098320025
20		12	098322002
50		4	098322005
250		4	098322025

9831L

Vlakafdichting - Lage sterkte

Ideaal voor monteren kleine delen welke onderhevig zijn aan periodiek onderhoud. Eenvoudiger delen te dementeren.



Temperatuur bereik (°C)	-50/+150
Max. afdichtingsvlak (mm)	0,10
Verwerkingstijd (minuten)	10/15
Uithardingstijd	3-6
Viscositeit (mPa.s) 25°C	500/800
Losbreek sterkte ISO-10964	6-10 Nm
Functionele sterkte ISO-10964	4-8 Nm

ml	€	🔧	📦
20	11,80	12	098310002
50	18,50	4	098310005
250	48,00	4	098310025
20		12	098312002
50		4	098312005
250		4	098312025



9841N

Zwarte azijnzuur-uithardende siliconenkit, bestand tegen hoge temperaturen, met handige drukdispenser

Bestand tegen temperaturen tot 240 ° C
Maakt permanent elastische afdichting mogelijk. Vervangt voorgevormde pakkingen.
De dispenser zorgt voor een gemakkelijke, nauwkeurige en gelijkmatige verspreiding van het product.
Polymeriseert door te reageren met luchtvochtigheid en vormt een elastische, duurzame pakking.
Ideaal voor oliecarters, oliepompen, behuizingen, versnellingsbakken, motoronderdelen die niet onder hoge druk staan en toepassingen die bestand zijn tegen hoge temperaturen. Hecht op niet-poreuze ondergronden, inclusief glas, gecoat hout, keramiek en email. Niet geschikt voor PE, PP, PC, PMMA, PTFE, zachte kunststoffen, neopreen en bitumineuze ondergronden.
Niet overschilderbaar



ml	€	12	12
200	30,00	098410120	098412120
200			

9841R

Rode azijnzuur-uithardende siliconenkit, bestand tegen hoge temperaturen, met handige drukdispenser

Bestand tegen temperaturen tot 300 ° C.
Maakt permanent elastische afdichting mogelijk. Vervangt voorgevormde pakkingen.
De dispenser zorgt voor een gemakkelijke, nauwkeurige en gelijkmatige verspreiding van het product.
Polymeriseert door te reageren met luchtvochtigheid en vormt een elastische, duurzame pakking.
Ideaal voor oven- en ovendeuren, platen, verwarmingssystemen, uitlaten, thermostaten, pompen, verwarmingsbuizen, motoronderdelen die niet onderhevig zijn aan hoge druk en toepassingen die bestand zijn tegen hoge temperaturen. Hecht op niet-poreuze ondergronden, inclusief glas, gecoat hout, keramiek en email. Niet geschikt voor PE, PP, PC, PMMA, PTFE, zachte kunststoffen, neopreen en bitumineuze ondergronden.
Niet overschilderbaar



ml	€	12	12
200	28,50	098410020	098412020
200			

9851

Snellijm voor structurele verbindingen

Op basis van ethyl cyaanacrylaat
Voor het verlijmen van vele materialen, waaronder metaal, plastic, leer, hout en verschillende substraten, zowel onderling als gecombineerd; fixeert snel.



Temperatuur (°C)	-55/+82
Viscositeit (mPa.s) 25 °C	80-120

g	€	12	12
5	6,00	098510500	098510002
20	11,00	098510002	098510005
50	22,50	098510005	098512500
5			098512500
20			098512002
50			098512005

9710 - LUBRIBETA universal

7-in-1 multifunctionele kruipolie

1. Los maken
2. Smering
3. Reinigt, ontvet
4. Roest bescherming
5. Voorkomt oxideren, voor elektrische contacten
6. Waterafstotend
7. Anti vries



ml	€	12	12
400	10,50	097100040	097101040
400			097102040

9712 - Ultra Sblock

Kruipolie, sterk penetrerend

Smerend, voorkomt oxideren, waterafstotend.
Ideaal voor het verwijderen van roest op bouten, moeren, schroeven en tandwielen.



ml	€	12	12
400	7,40	097120040	097121040
400			097122040

9720 - Multi Grease

Multifunctioneel vet

Uitermate geschikt voor het smeren van kettingen, tandwielen en bewegende metalen delen. Bestendig tegen frictie en weersomstandigheden. Goede hechting. Druppelt niet na.



ml	€	12	12
400	8,70	097200040	097201040
400			097202040

9722 - Lithium Grease

Wit lithium vet

Gebaseerd op vet met lithium, titanium en zink oxide zeep bestanddelen. Ideaal voor het smeren van tandwielen, lagers en verbindingstukken. Specifiek voor marine toepassingen. Zeer bestendig tegen water, zeezout, weersomstandigheden en hoge temperaturen (tot 150 °C). Druppelt niet.



ml	€	12	12
400	10,10	097220040	097221040
400			097222040



9724 - PTFE Grease

PTFE bevattend vet

Uitermate geschikt voor het smeren van industriële kettingen en bewegende delen welke onderhevig zijn aan zware belasting en lage draaisnelheden. Geschikt voor toepassing op kunststof en rubber. Geheel kleurloos. Waterafstotend en bestendig tegen roest.



ml	€		
400	11,00	12	097240040
400		12	097241040
400		12	097242040

9726 - Copper Grease

Copper grease

Geschikt voor het smeren van verbindingstukken, bouten, tandwielen, aandrijfassen en andere metalen delen welke onderhevig zijn aan hoge temperaturen (tot 1,000 °C). Beschermend, slijtage werend. Voorkomt oxidatie. Druppelt niet.



ml	€		
400	13,50	12	097260040
400		12	097261040
400		12	097262040

9729 - Silic Spray

Silicone spray

Geschikt voor het smeren van kunststof, rubber en metalen delen. Beschermend tegen corrosie. Losmakend. Antistatisch. Waterafstotend. Kan gebruikt worden op glad hout, kunststof en rubber. Vrij van oplosmiddelen.



ml	€		
400	7,50	12	097290040
400		12	097291040
400		12	097292040

9738 - Cutting Oil

Snijolie

Vermindert de wrijving en beschermt. Geschikt voor frezen, boren, draadtappen, uitboren zowel handmatig als machinaal.

Zeer bestendig tegen roest.

Water afwasbaar. Vrij van oplosmiddelen.



ml	€		
400	8,50	12	097380040
400		12	097381040
400		12	097382040

9740 - Brake Cleaner

Remmen reiniger

Ideaal voor het schoonmaken van remschijven, remklauwen en motoren. Verwijdert vet en teer en laat geen residu achter. Verdampst snel. Is geschikt voor kunststof en rubber.



ml	€		
500	7,60	12	097400050
500		12	097401050
500		12	097402050

9741 - Multi Cleaner

Multifunctionele wasmiddel/ontvetter

Wasmiddel en ontvetter voor oplossen van vet, olie, teer, silicone en lijm.

Geschikt voor het reinigen van metaal, harde kunststof, keramiek, staal en aluminium delen.

Vrij van olieresten.



ml	€		
400	8,40	12	097410040
400		12	097411040
400		12	097412040

9742 - Contact Cleaner

Contactspray

Verwijdert vet en vuil, zonder het nalaten van een olie residu. Verdampst snel. Is geschikt voor kunststof en rubber.



ml	€		
400	8,00	12	097420040
400		12	097421040
400		12	097422040

9743 - SURFACE CLEANER

Schuimreiniger

Schuimreiniger voor alle soorten oppervlakken, gereedschappen en stoffen.

Op basis van quaternaire ammoniumzouten vormt het een actief schuim dat vuil en vet reinigt en verwijdert.

Verwijdert slechte geuren. Afspoelen is niet nodig. Geen ontsmettingsmiddel.



ml	€		
500	16,20	12	097430050
500		12	097431050
500		12	097432050

9745 - Carb Cleaner

Carburateur reiniger

Specifiek voor het in en uitwendig schoonmaken van carburateurs, luchtkleppen en gasklephuizen. Verwijdert alle koolstofhoudende residu, bezinksel en onzuiverheden. Laat geen olie residu na.



ml	€		
400	8,50	12	097450040
400		12	097451040
400		12	097452040

9746 - Clima Cleaner

airco reiniger

Reiniger voor industriële, civiele en auto-airconditioners. Dankzij de dikke schuimformule en het bijgeleverde slangetje kunnen vuil, afzettingen en geuren uit kanalen worden verwijderd, waardoor een aangename geur achterblijft.



ml	€		
400	13,90	12	097460040
400		12	097461040
400		12	097462040

9749 - Air Spray

Luchtspray reiniger

Aërosolspray met gecompriëerd gas. Ideaal voor het verwijderen van stof uit hoekjes, tandwielen, elektrische onderdelen, toetsenborden en kwetsbare mechanismen in het algemeen. Door de spuitbus met spuitrietje zijn moeilijk bereikbare onderdelen goed bereikbaar.



ml	€		
400	8,95	12	097490040
400		12	097491040
400		12	097492040

9752 - Zinc 98%

Zinkspray

Algehele bescherming, zeer geschikt voor gegalvaniseerde ijzeren delen. Sterk hechtend, vormt het een elastisch laag met een zeer lichte kleur, gelijkwaardig aan het gegalvaniseerd stuk. Uitermate bestendig tegen oxidatie, slijtage en weersomstandigheden. Is overschilderbaar. Druppelt niet.



ml	€		
400	9,70	12	097520040
400		12	097521040
400		12	097522040

9755 - Welding Spray

Las anti-spat spray

Siliconenvrije anti-spatspray voor lassen. Het voorkomt aanhechting van slakken, waardoor het lassen gemakkelijker en sneller gaat. Voor gebruik op onderdelen die moeten worden gelast en als bescherming voor lastoortsmondstukken. Het maakt het mogelijk om volgende bewerkingen uit te voeren, b.v. schilderen, verzinken en verchromen. Geen dampen. Gemakkelijk te verwijderen. Vrij van chloor.



ml	€		
400	8,80	12	097550040
400		12	097551040
400		12	097552040

9765 - Deicer Spray

Ontdooi spray

Ontdooier en ontdooispray, voor het verwijderen van ijs en rijp van ramen. Ook ideaal voor bevroren sloten en mechanismen. Effectief tot -40 ° C. Niet vet, vlek vrij. Tast behandelde oppervlakken, rubber en kunststoffen niet aan.



ml	€		
400	14,70	12	097650040
400		12	097651040
400		12	097652040

9775 - Water Stop

Waterdichtmakende spray

Waterdichtmakende, waterafstotende spray voor textiel en leer. Ideaal voor schoenen, jassen en kleding in het algemeen. Het maakt het mogelijk stoffen waterdicht te maken, zonder het ademend vermogen aan te tasten. Door de vlekbestendige eigenschappen zijn stoffen gemakkelijker te wassen. Verbeterde weerstand tegen buigen en schuren.



ml	€		
400	15,90	12	097750040
400		12	097751040
400		12	097752040

9881U

Industrieel alkalisch reinigingsmiddel voor ultrasonische tank

Industrieel alkalisch reinigingsmiddel, geconcentreerd, op waterbasis. Voor ultrasonisch reinigen en andere zuiveringsprocessen. Hiermee kunnen reserveonderdelen en metalen onderdelen in het algemeen (injectoren, carburateurs, kleppen enz.) nauwkeurig en effectief worden gereinigd. Verwijdert olie, vet, smeermiddelen, lijmresten, hars en was. Ook geschikt voor het reinigen van aluminium onderdelen.



Lt	€		
1	39,50	1	098810010
1		1	098812010

9882R

Roestverwijderings vloeistof

Roestverwijderingsvloeistof op waterbasis voor ijzer, staal, roestvrij staal, gietijzer en verchroomde platen. Verwijdert de bovenste geoxideerde laag, zonder het onderliggende metaal aan te tasten. Verdunning: van puur tot max. 1: 1. Minimale bedrijfstemperatuur: 15 ° C. Bedrijfstijden: 30 ' - 24 / 48u (voor zware roest). Biologisch afbreekbaar en 100% oplosbaar in water.



Lt	€		
1	47,00	1	098820010
1		1	098822010



Beta ABRASIVES

Een uitgebreid assortiment harde en flexibele schuur en slijpschijven, bestaande uit meer dan 500 gecodeerde artikelen, volledig gemaakt in Italië. Ontworpen en ontwikkeld om te voldoen aan alle industriële en professionele vereisten voor snijden en materiaalverwijdering.

Beta Utensili vertrouwt op het Beta Abrasives-project om er zeker van te zijn om marktprofessionals een uitgebreid productassortiment en een ongeëvenaarde technische standaard aan te bieden, als resultaat van de productievaardigheden die AbraBeta heeft bijgedragen.



HARDE DOORSLIJP EN AFBRAAMSCHIJVEN

Harde schijven vormen de hoofdcategorie van deze nieuwe productfamilie; vandaar dat Beta Utensili zich heeft geconcentreerd op het selecteren van de allerbeste materialen en soorten.

Snij- en slijpschijven zijn de snelste en meest veelzijdige hulpmiddelen voor het bewerken van een grote verscheidenheid aan materialen, met behulp van de meest geschikte gereedschappen, of het nu gaat om haakse slijpers of stationaire machines.

DISC SHAPES

 **T42**
doorslijpschijf met doorgezet center

 **T41**
doorslijpschijf met een vlak center

 **T27**
afbraamschijf met een doorgezet center

TOP
— LINE —

Compromisloze kwaliteit: voor extreem veeleisende gebruikers

PREMIUM
— LINE —

Hoge kwaliteit voor hoge prestaties, tegen concurrerende prijzen, voor de beste prijs / kwaliteit verhouding.

CERTIFICATIE



PICTOGRAMMEN OP DE SCHIJVEN



Draag een veiligheidsbril



Draag beschermende handschoenen



Draag gehoorbescherming



Draag beschermende kleding



Draag een stofmasker



Lees de gebruiksinstructies



Schijf uitsluitend voor doorslijpen
- niet voor afbramen



Niet gebruiken bij beschadiging van de schijf



Ijzer, zwavel en chloorvrij ($\leq 0.1\%$)

Product houdbaarheid

Product houdbaarheid: 3 jaar vanaf productiedatum. "V01" zoals gegraveerd op de metalen ring in het midden van de schijf, geeft het kwartaal van de vervaldatum aan. Voorbeeld: "V07 / 2022" geeft aan dat de schijf is vervaardigd in het 3e kwartaal van 2019 en kan worden gebruikt tot het einde van het 3e kwartaal van 2022.



	Kwartaal
V01	Jan-Mar
V04	Apr-Jun
V07	Jul-Sep
V10	Oct-Dec



STIFTSLIJPSTENEN

Stiftslijpstenen voor het gebruik op stiftslijpmachines. Vervaardigd in verschillende vormen geschikt voor verschillende werkzaamheden, met 3 soorten schuurmateriaal.



LAMELLEN SLIJPSTIFEN

Op de as gemonteerde lamellenschijven zijn voorzien van flexibele lamellen waarmee een precieze, homogene afwerking kan worden verkregen op onregelmatige vormen en oppervlakken.



LAMELLEN SCHIJVEN

Lamellenschijven bestaan uit overlappende stroken schuurmateriaal die op een steunpad zijn gelijmd; ze zijn een uitstekende keuze voor voorbereiding en afwerking. Over het algemeen zorgen ze voor een snellere verwijdering, homogenere afwerking, minder trillingen, minder geluid en lagere bedrijfstemperaturen dan slijpschijven. Ze zijn verkrijgbaar met lamellen gemaakt van verschillende schuurmaterialen, met verschillende korrelgroottes en twee verschillende soorten steunpads.

Vormen

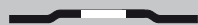

Vlak

Gebruikt in een maximale hoek van 15 ° in vergelijking met het werkblad, maakt het werken van vlakke oppervlakken en randen mogelijk.

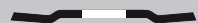

Conisch

Gebruikt in een hoek tussen 15 ° en 25 ° in vergelijking met het werkblad, maakt het werk op oneffen oppervlakken gemakkelijker. Het zorgt voor een groter contactoppervlak tussen de schijf en het te bewerken oppervlak. De lamellen kunnen worden gebruikt totdat ze volledig versleten zijn.

TOP

— LINE —

Compromisloze kwaliteit: voor extreem veeleisende gebruikers.

PREMIUM

— LINE —

Hoge kwaliteit voor hoge prestaties, tegen concurrerende prijzen, voor de beste prijs / kwaliteit verhouding.



LAMELLEN SLIJPWIELEN

Lamellen slijpwielen zijn geschikt voor het bewerken van onregelmatige randen, contouren en oppervlakken op basis van hoge lamelflexibiliteit.



SCHUURVLIESROLLER VOOR SATINEERMACHINES

Beta's wielen (of rollen) voor atineermachines zijn de beste oplossing voor het afwerken van elk materiaal.

Graden van korrel/afwerking

C	Grof
M	Medium
F	Fijn
VF	Zeer fijn
UF	Ultra fijn



RADIAAL SCHIJVEN EN FIBER SCHIJVEN

Speciale reinigingsschijven produceren opmerkelijke polijst effecten die resulteren in snelle, precieze werkprocessen.



SCHUURVLIES ROLLEN

Een breed scala van schuurvliesrollen gemaakt van schuurpapier en schuurlinnen, van uitstekende kwaliteit, voor een aantal diverse toepassingen.

Raadpleeg voor meer informatie de speciale catalogus die beschikbaar is op de Beta-website:
www.beta-tools.com

11001

Doorslijpschijven voor staal met doorgezet center

A30S EN 12413



	Ø mm	S mm	F mm	max. rpm	€	10	110010118
11001	115	3,2	22,23	13300	1,89	10	110010118
11001	125	3,2	22,23	12200	2,02	10	110010128
11001	230	3,2	22,23	6600	4,25	10	110010233

11001H

Doorslijpschijven voor staal met doorgezet center

HARD

A30T EN 12413



	Ø mm	S mm	F mm	max. rpm	€	10	110010733
11001H	230	3,2	22,23	6600	4,25	10	110010733

11003

Doorslijpschijven voor staal met vlak center

A30T EN 12413



	Ø mm	S mm	F mm	max. rpm	€	10	110030117
11003	115	2,5	22,23	13300	1,80	10	110030117
11003	125	2,5	22,23	12200	1,78	10	110030127
11003	180	2,5	22,23	8500	3,75	10	110030182
11003	230	2,5	22,23	6600	4,10	10	110030232

11011

Afbraamschijven voor staal met doorgezet center

A24N EN 12413



	Ø mm	S mm	F mm	max. rpm	€	10	110110115
11011	115	6,5	22,23	13300	2,60	10	110110115
11011	125	6,5	22,23	12200	2,78	10	110110125
11011	180	6,5	22,23	8500	5,25	10	110110180
11011	230	6,5	22,23	6600	8,00	10	110110230

11011H

Afbraamslijpschijven voor staal met doorgezet center

HARD

A24R EN 12413



	Ø mm	S mm	F mm	max. rpm	€	10	110110615
11011H	115	6,5	22,23	13300	2,54	10	110110615
11011H	125	6,5	22,23	12200	2,78	10	110110625
11011H	180	6,5	22,23	8500	5,25	10	110110680
11011H	230	6,5	22,23	6600	8,00	10	110110730

11018

Extra dunne doorslijpschijven voor staal met vlak center

60 m/s

A46N EN 12413



	Ø mm	S mm	F mm	max. rpm	€	10	110180030
11018	300	2,5	25,40	4010	7,05	10	110180030
11018	350	3,0	25,40	3440	11,10	10	110180035
11018	400	3,2	25,40	3010	14,10	10	110180040

11019

Extra dunne doorslijpschijven voor staal met vlak center

80 m/s

A24N EN 12413



A24N

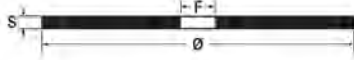

	Ø mm	S mm	F mm	max. rpm	€		
11019	300	3,8	25,40	5100	8,55	10	110190030
11019	350	4,2	25,40	4400	13,10	10	110190035
11019	400	4,5	25,40	3800	16,80	10	110190040

11021

Doorslijpschijven voor staal en roestvast staal met doorgezet center

A30Q EN 12413



A30Q



	Ø mm	S mm	F mm	max. rpm	€		
11021	115	3,2	22,23	13300	1,91	10	110210118
11021	125	3,2	22,23	12200	1,99	10	110210128
11021	180	3,2	22,23	8500	3,80	10	110210183
11021	230	3,2	22,23	6600	4,30	10	110210233

11023

Afbraamschijven voor staal en roestvast staal met doorgezet center

A24Q EN 12413



A24Q



	Ø mm	S mm	F mm	max. rpm	€		
11023	115	6,5	22,23	13300	2,54	10	110230115
11023	125	6,5	22,23	12200	2,77	10	110230125
11023	230	6,5	22,23	6600	8,00	10	110230230

11024

Doorslijpschijven voor staal en roestvast staal, dun, met doorgezet center

TOP LIJN

A46U EN 12413



TOP
LINE

A46U



	Ø mm	S mm	F mm	max. rpm	€		
11024	230	2,0	22,23	6600	5,55	10	110240230

11031-11038

Doorslijpschijven voor staal en roestvast staal, dun, met vlak center

TOP LIJN

Ø 65 mm

A46U EN 12413



TOP
LINE

A46U



	Ø mm	S mm	F mm	max. rpm	€		
11031	65	1,0	6,00	24000	1,68	25	110310006
11031	65	1,0	10,00	24000	1,68	25	110310010
11031	65	1,6	10,00	24000	1,68	25	110310020

	Ø mm	S mm	F mm	max. rpm	€		
11032	76	1,0	6,00	20200	1,68	25	110320006
11032	76	1,0	10,00	20200	1,68	25	110320010
11032	76	1,6	10,00	20200	1,68	25	110320020

	Ø mm	S mm	F mm	max. rpm	€		
11034	115	1,0	22,23	13300	2,38	25	110340022
11034	115	1,2	22,23	13300	2,38	25	110340042
11034	115	1,6	22,23	13300	2,38	25	110340062

	Ø mm	S mm	F mm	max. rpm	€		
11035	125	1,0	22,23	12200	2,60	25	110350022
11035	125	1,2	22,23	12200	2,60	25	110350042
11035	125	1,6	22,23	12200	2,60	25	110350062

	Ø mm	S mm	F mm	max. rpm	€		
11037	180	2,0	22,23	8500	4,25	10	110370022

	Ø mm	S mm	F mm	max. rpm	€		
11038	230	2,0	22,23	6600	5,10	10	110380022

11040

Doorslijpschijven voor staal en roestvast staal, dun, met doorgezet center

PREMIUM LIJN

A36Q EN 12413



A36Q

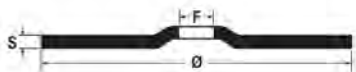

	Ø	S	F	max.	€		
	mm	mm	mm	rpm			
11040	230	2,0	22,23	6600	4,05	10	110400230

11045-11046

Doorslijpschijven voor staal en roestvast staal, dun, met vlak center

PREMIUM LIJN

Ø 115 mm

A46Q EN 12413



A46Q



	Ø	S	F	max.	€		
	mm	mm	mm	rpm			
11045	115	1,0	22,23	13300	1,89	25	110450010
11045	115	1,2	22,23	13300	1,89	25	110450012
11045	115	1,6	22,23	13300	1,89	25	110450016
11046	125	1,0	22,23	12200	2,02	25	110460010
11046	125	1,2	22,23	12200	2,02	25	110460012
11046	125	1,6	22,23	12200	2,02	25	110460016

11048-11049

Doorslijpschijven voor staal en roestvast staal, dun, met vlak center

Ø 180 mm

A36Q EN 12413



A36Q

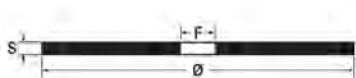

	Ø	S	F	max.	€		
	mm	mm	mm	rpm			
11048	180	2,0	22,23	8500	2,88	10	110480019

	Ø	S	F	max.	€		
	mm	mm	mm	rpm			
11049	230	2,0	22,23	6600	3,90	10	110490019

11050

Afbraamschijven voor staal, met zirkonium korrel en doorgezet center

ZA24R - EN 12413



ZA24R



	Ø	S	F	max.	€		
	mm	mm	mm	rpm			
11050	115	6,5	22,23	13300	4,35	10	110500115
11050	125	6,5	22,23	12200	5,45	10	110500125
11050	230	7,0	22,23	6600	13,10	10	110500230

11069

Doorslijpschijven voor steen en marmer met doorgezet center

C30S EN 12413



C30S



	Ø	S	F	max.	€		
	mm	mm	mm	rpm			
11069	115	3,2	22,23	13300	2,02	10	110690115
11069	125	3,2	22,23	12200	2,10	10	110690125
11069	230	3,2	22,23	6600	4,75	10	110690230

Beta

11100

Stiftslijpstenen,
roze korund slijpkorrel, cilinder vorm

As \varnothing 3 x 37 mm

EN 12413

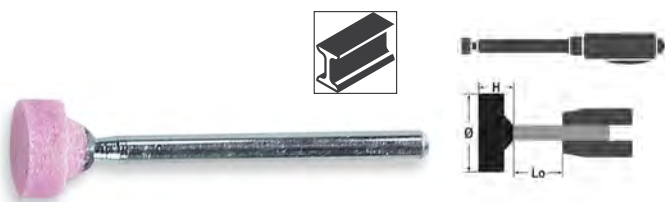

	\varnothing mm	h mm	max. rpm Lo=13 mm		€		
11100	4	8	130.000	AR60P5V	1,07	25	111000004
11100	6	10	93.100	AR60P5V	1,07	25	111000006
11100	8	12	64.500	AR60P5V	1,07	25	111000008
11100	10	10	60.100	AR60P5V	1,07	25	111000011
11100	10	12	52.700	AR60P5V	1,07	25	111000012
11100	12	15	37.300	AR60P5V	1,21	25	111000013

11101

Stiftslijpstenen,
roze korund slijpkorrel, cilinder vorm

As \varnothing 6 x 40 mm

EN 12413

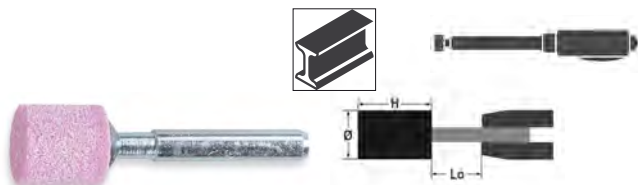

	\varnothing mm	h mm	max. rpm Lo=13 mm		€		
11101	4	8	130.000	AR60P5V	1,28	25	111010004
11101	5	10	130.000	AR60P5V	1,28	25	111010005
11101	6	10	130.000	AR60P5V	1,28	25	111010006
11101	8	10	119.300	AR60P5V	1,28	25	111010008
11101	10	10	95.400	AR60P5V	1,28	25	111010010
11101	10	15	95.400	AR60P5V	1,28	25	111010011
11101	10	20	86.600	AR60P5V	1,40	25	111010012
11101	10	25	72.700	AR60P5V	1,53	25	111010013
11101	10	32	58.700	AR60P5V	1,60	25	111010014
11101	12	10	79.500	AR60P5V	1,15	25	111010015
11101	12	15	79.500	AR60P5V	1,21	25	111010016
11101	12	20	79.500	AR60P5V	1,33	25	111010017
11101	15	3	63.600	AR60P5V	1,15	25	111010018
11101	15	15	63.600	AR60P5V	1,28	25	111010019
11101	16	20	59.600	AR46P5V	1,47	25	111010020
11101	16	25	56.900	AR46P5V	1,53	25	111010021
11101	16	32	45.100	AR46P5V	1,73	25	111010022
11101	20	4	47.700	AR60P5V	1,15	25	111010023
11101	20	15	47.700	AR46P5V	1,28	25	111010024
11101	20	20	47.700	AR46P5V	1,53	25	111010025
11101	20	25	46.100	AR46P5V	1,60	25	111010026
11101	20	30	38.900	AR46P5V	1,74	25	111010027
11101	20	40	29.00	AR46P5V	2,22	25	111010028
11101	25	10	38.100	AR60P5V	1,28	25	111010030
11101	25	25	37.200	AR36/46P5V	1,74	25	111010031
11101	25	40	23.300	AR36/46P5V	2,61	10	111010032
11101	30	10	31.800	AR60P5V	1,40	25	111010034
11101	30	30	26.200	AR36/46P5V	2,07	25	111010035
11101	30	40	19.500	AR36/46P5V	2,82	10	111010036
11101	32	20	29.800	AR36P5V	1,99	25	111010037
11101	32	32	23.100	AR36P5V	2,68	10	111010038
11101	40	10	23.800	AR36/46P5V	2,07	25	111010041
11101	40	20	23.800	AR36P5V	2,82	10	111010042
11101	40	25	23.400	AR36P5V	2,92	10	111010043
11101	40	30	19.700	AR36P5V	3,25	10	111010044
11101	40	40	14.700	AR36P5V	3,90	10	111010045
11101	50	15	19.000	AR36P5V	3,15	10	111010051
11101	50	25	18.800	AR36P5V	3,75	10	111010052
11101	60	10	15.900	AR36P5V	3,45	10	111010060

11102

Stiftslijpstenen,
roze korund slijpkorrel, cilinder vorm

As \varnothing 6 x 80 mm

EN 12413

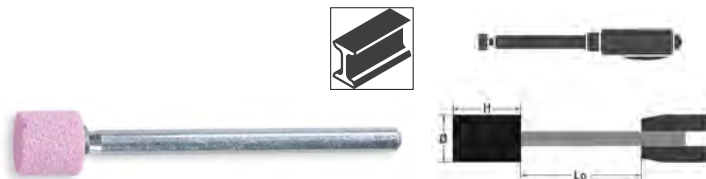

	\varnothing mm	h mm	max. rpm Lo=13 mm		€		
11102	8	20	100.500	AR60P5V	1,67	25	111020008
11102	10	15	95.400	AR60P5V	1,59	25	111020010
11102	10	30	62.200	AR60P5V	1,93	25	111020020
11102	12	15	79.500	AR60P5V	1,60	25	111020022
11102	15	15	63.600	AR60P5V	1,73	25	111020035
11102	15	30	51.000	AR46P5V	2,16	25	111020040
11102	20	30	38.900	AR46P5V	2,21	25	111020060

11105

Stiftslijpstenen,
roze korund slijpkorrel,
cilinder/driehoeking vorm

As \varnothing 6 x 40 mm

EN 12413

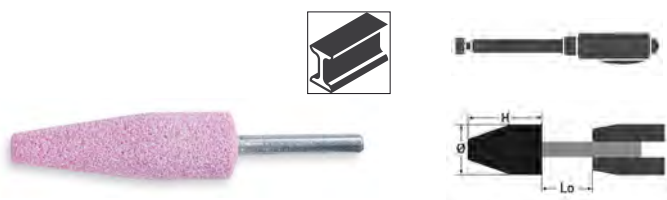

	\varnothing mm	h mm	max. rpm Lo=13 mm		€		
11105	20	65	16.200	AR36/46P5V	4,10	25	111050020

11106

Stiftslijpstenen,
roze korund slijpkorrel,
trapezium vorm

As \varnothing 3 x 37 mm

EN 12413

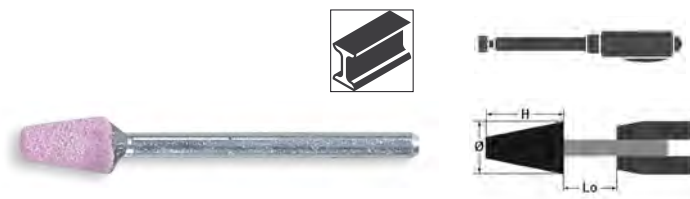

	\varnothing mm	h mm	max. rpm Lo=13 mm		€		
11106	6	10	93.100	AR60P5V	1,40	25	111060006

11107

Stiftslijpstenen,
roze korund slijpkorrel,
trapezium vorm

As \varnothing 6 x 40 mm

EN 12413

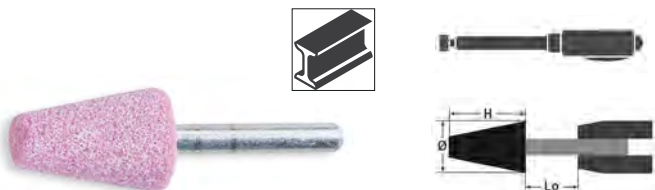

	\varnothing mm	h mm	max. rpm Lo=13 mm		€		
11107	12	20	79.500	AR60P5V	1,60	25	111070012
11107	15	25	60.400	AR46P5V	1,93	25	111070015
11107	20	30	38.900	AR46P5V	2,22	25	111070020
11107	25	40	23.300	AR36/46P5V	3,25	10	111070025

11110

Stiftslijpstenen,
roze korund slijpkorrel,
keramische binding, ronde kegelvorm

As \varnothing 3 x 37 mm

EN 12413

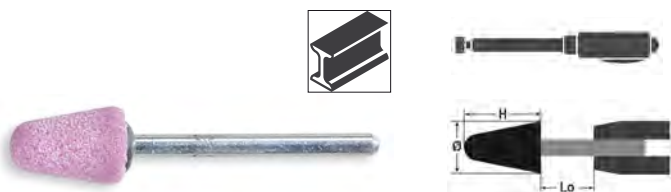

	\varnothing mm	h mm	max. rpm Lo=13 mm		€		
11110	10	15	44.300	AR60P5V	1,40	25	111100010

11111

Stiftslijpstenen,
roze korund slijpkorrel, ronde kegelvorm

As \varnothing 6 x 40 mm

EN 12413

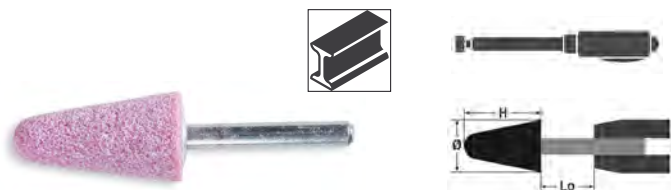

	\varnothing mm	h mm	max. rpm Lo=13 mm		€		
11111	10	20	86.600	AR60P5V	1,67	25	111110010
11111	15	30	51.000	AR46P5V	2,14	25	111110015
11111	16	45	31.400	AR46P5V	2,92	25	111110016
11111	20	28	41.500	AR46P5V	2,22	25	111110020
11111	20	40	29.000	AR46P5V	2,82	25	111110021
11111	30	50	15.100	AR36/46P5V	4,15	10	111110030

11115

Stiftslijpstenen,
roze korund slijpkorrel, spitsboogvorm

As \varnothing 3 x 37 mm

EN 12413

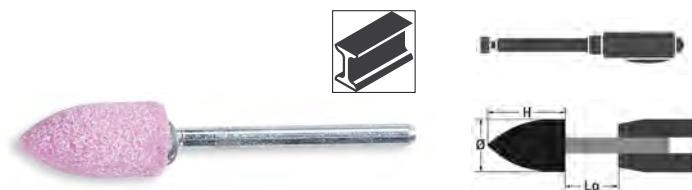

	\varnothing mm	h mm	max. rpm Lo=13 mm		€		
11115	10	20	34.700	AR60P5V	1,53	25	111150010

11116

Stiftslijpstenen,
roze korund slijpkorrel,
spitsboogvorm

As \varnothing 6 x 40 mm

EN 12413

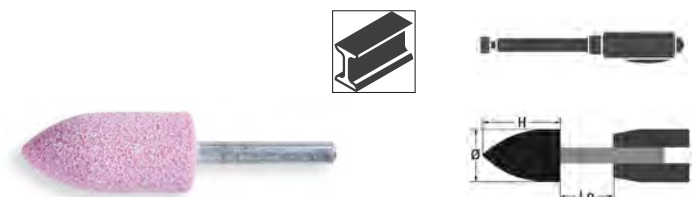

	\varnothing mm	h mm	max. rpm Lo=13 mm		€		
11116	10	20	86.600	AR60P5V	1,67	25	111160010
11116	18	30	43.000	AR46P5V	2,22	25	111160018
11116	20	50	22.500	AR36/46P5V	3,45	25	111160020
11116	22	70	13.400	AR36/46P5V	5,25	10	111160022

11120

Stiftslijpstenen,
roze korund slijpkorrel,
ronde pyramide vorm

As \varnothing 3 x 37 mm

EN 12413

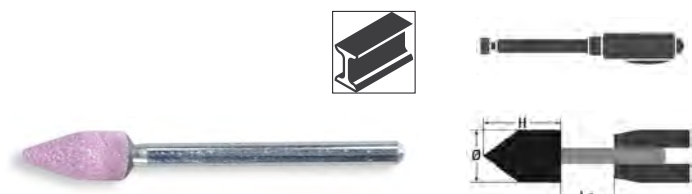

	\varnothing mm	h mm	max. rpm Lo=13 mm		€		
11120	6	13	77.800	AR60P5V	1,40	25	111200006

Beta

11121

Stiftslijpstenen,
roze korund slijpkorrel,
ronde pyramide vorm

As $\varnothing 6 \times 40$ mm

EN 12413

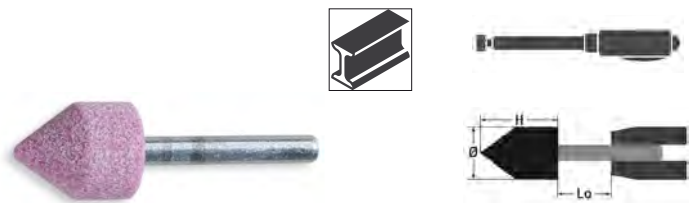

	Ø mm	h mm	max. rpm Lo=13 mm		€		
11121	6	25	100.700	AR60P5V	2,22	25	111210007
11121	12	20	79.500	AR60P5V	1,60	25	111210012
11121	20	25	46.100	AR46P5V	1,98	25	111210020
11121	25	25	37.200	AR36/46P5V	2,22	25	111210025
11121	30	30	26.200	AR36/46P5V	2,62	25	111210030

11125

Stiftslijpstenen,
roze korund slijpkorrel,
ronde cilinder vorm

As $\varnothing 6 \times 40$ mm

EN 12413

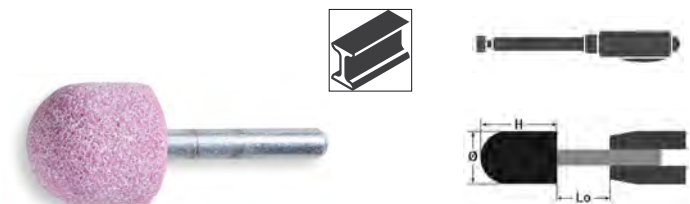

	Ø mm	h mm	max. rpm Lo=13 mm		€		
11125	6	20	117.700	AR60P5V	1,79	25	111250006
11125	25	25	37.200	AR36/46P5V	2,22	25	111250025
11125	30	50	15.100	AR36/46P5V	4,15	10	111250030
11125	40	40	14.700	AR36P5V	4,95	10	111250040

11130

Stiftslijpstenen,
roze korund slijpkorrel,
bol vorm

As $\varnothing 3 \times 37$ mm

EN 12413

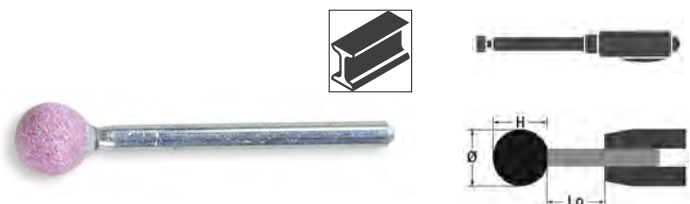

	Ø mm	h mm	max. rpm Lo=13 mm		€		
11130	6	6	124.900	AR60P5V	1,40	25	111300006
11130	8	8	84.800	AR60P5V	1,40	25	111300008
11130	10	10	60.100	AR60P5V	1,40	25	111300010

11131

Stiftslijpstenen,
roze korund slijpkorrel,
bol vorm

As $\varnothing 6 \times 40$ mm

EN 12413

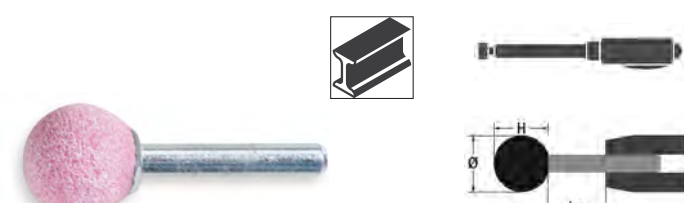

	Ø mm	h mm	max. rpm Lo=13 mm		€		
11131	10	10	95.400	AR60P5V	1,53	25	111310010
11131	15	15	63.600	AR60P5V	1,60	25	111310015
11131	20	20	47.700	AR46P5V	1,93	25	111310020
11131	25	25	37.200	AR36/46P5V	2,22	25	111310025
11131	30	30	26.200	AR36/46P5V	2,62	25	111310030

11132

Stiftslijpstenen,
roze korund slijpkorrel,
bol vorm

As $\varnothing 6 \times 80$ mm

EN 12413

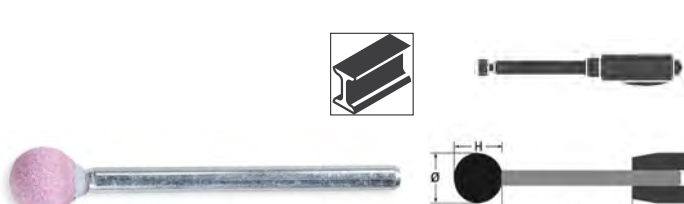

	Ø mm	h mm	max. rpm Lo=13 mm		€		
11132	10	10	95.400	AR60P5V	1,79	25	111320010
11132	15	15	63.600	AR60P5V	1,98	25	111320015
11132	20	20	47.700	AR46P5V	2,35	25	111320020

11135

Stiftslijpstenen,
roze korund slijpkorrel,
schijf vorm

As $\varnothing 6 \times 40$ mm

EN 12413

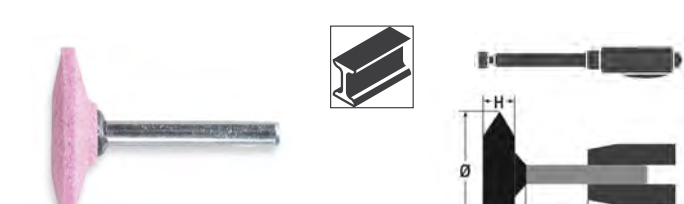

	Ø mm	h mm	max. rpm Lo=13 mm		€		
11135	30	6	31.800	AR60P5V	1,74	25	111350030
11135	40	10	23.800	AR36/46P5V	2,68	25	111350040

11140

Stiftslijpstenen,
grijs/roze korund slijpkorrel,
cilinder vorm

As \varnothing 6 x 40 mm

EN 12413

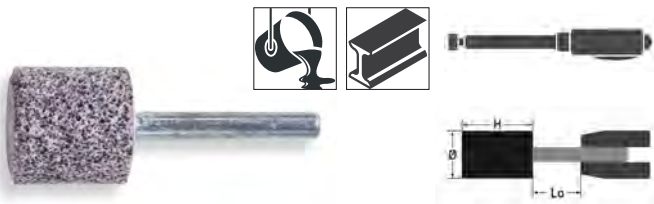

	\varnothing mm	h mm	max. rpm Lo=13 mm		€		
11140	20	30	38.900	A/AR24R5V	1,74	25	111400020
11140	25	25	37.200	A/AR24R5V	1,74	25	111400025
11140	30	30	26.200	A/AR24R5V	2,07	25	111400030
11140	50	10	19.000	A/AR24R5V	2,82	10	111400050

11141

Stiftslijpstenen,
grijs/roze korund slijpkorrel,
cilinder vorm

As \varnothing 6 x 80 mm

EN 12413

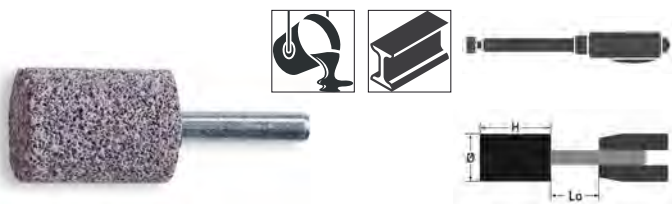

	\varnothing mm	h mm	max. rpm Lo=13 mm		€		
11141	20	40	46.800	A/AR24R5V	2,46	25	111410020
11141	30	40	31.800	A/AR24R5V	3,00	10	111410030
11141	40	40	23.800	A/AR24R5V	4,20	10	111410040

11145

Stiftslijpstenen,
grijs/roze korund slijpkorrel,
spitsboogvorm vorm

As \varnothing 6 x 40 mm

EN 12413

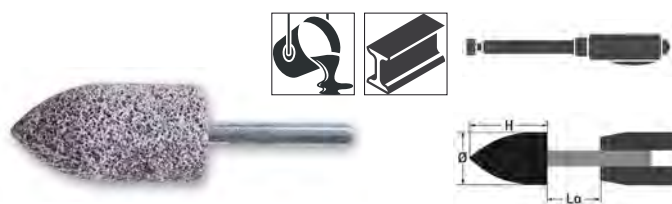

	\varnothing mm	h mm	max. rpm Lo=13 mm		€		
11145	20	30	38.900	A/AR24R5V	2,22	25	111450020
11145	25	50	18.100	A/AR24R5V	3,90	10	111450025

11200A-11200B

Lamellen slijpschijf met zirkonium schuurmateriaal,
kunststof steunschijf, enkele lamel constructie

Vlak

PREMIUM LIJN

\varnothing 115 mm

EN 13743

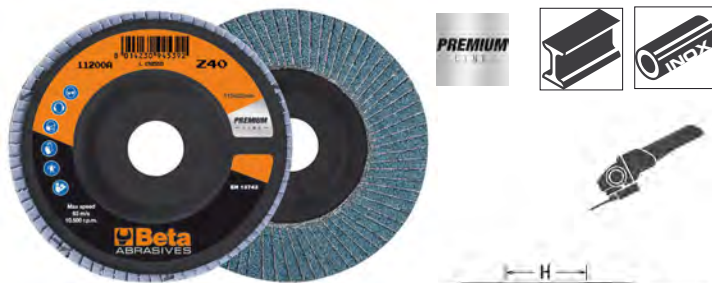

	\varnothing mm	P	F mm		€		
11200A	115	40	22,23		3,15	10	112000004
11200A	115	60	22,23		3,15	10	112000006
11200A	115	80	22,23		3,15	10	112000008
11200A	115	120	22,23		3,15	10	112000012

	\varnothing mm	P	F mm		€		
11200B	125	40	22,23		3,80	10	112000104
11200B	125	60	22,23		3,80	10	112000106
11200B	125	80	22,23		3,80	10	112000108

11202A÷11202C

Lamellen slijpschijf met zirkonium schuurmateriaal,
kunststof steunschijf, dubbele lamel constructie

Vlak

PREMIUM LIJN

\varnothing 115 mm

EN 13743

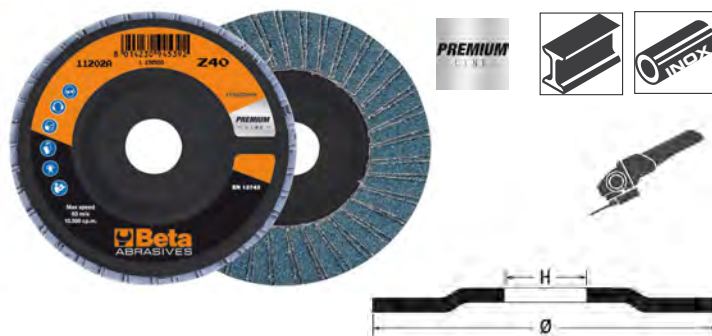

	\varnothing mm	P	F mm		€		
11202A	115	40	22,23		3,15	10	112020004
11202A	115	60	22,23		3,15	10	112020006
11202A	115	80	22,23		3,15	10	112020008
11202A	115	120	22,23		3,15	10	112020012

	\varnothing mm	P	F mm		€		
11202B	125	40	22,23		3,80	10	112020104
11202B	125	60	22,23		3,80	10	112020106
11202B	125	80	22,23		3,80	10	112020108

	\varnothing mm	P	F mm		€		
11202C	180	40	22,23		8,05	10	112020204
11202C	180	60	22,23		8,05	10	112020206

11204A-11204B

Lamellen slijpschijf met zirkonium schuurmateriaal, glasfiber steunschijf, enkele lamel constructie

Vlak
PREMIUM LIJN
Ø 115 mm
EN 13743

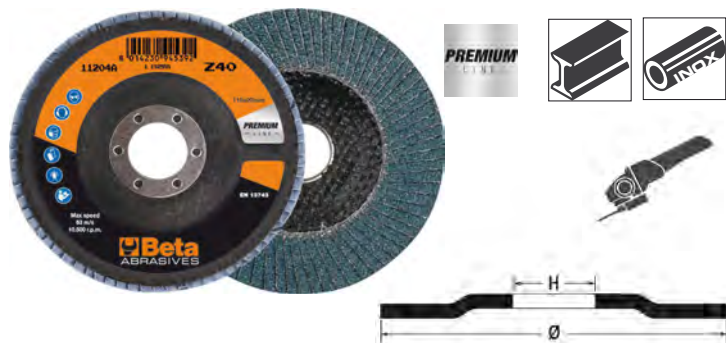

	Ø mm	P mm	F mm	€		
11204A	115	40	22,23	3,10	10	112040004
11204A	115	60	22,23	3,10	10	112040006
11204A	115	80	22,23	3,10	10	112040008
11204A	115	120	22,23	3,10	10	112040012

	Ø mm	P mm	F mm	€		
11204B	125	40	22,23	3,65	10	112040104
11204B	125	60	22,23	3,65	10	112040106
11204B	125	80	22,23	3,65	10	112040108

11208A-11208B

Lamellen slijpschijf met zirkonium schuurmateriaal, glasfiber steunschijf, dubbele lamel constructie

Vlak
PREMIUM LIJN
Ø 115 mm
EN 13743

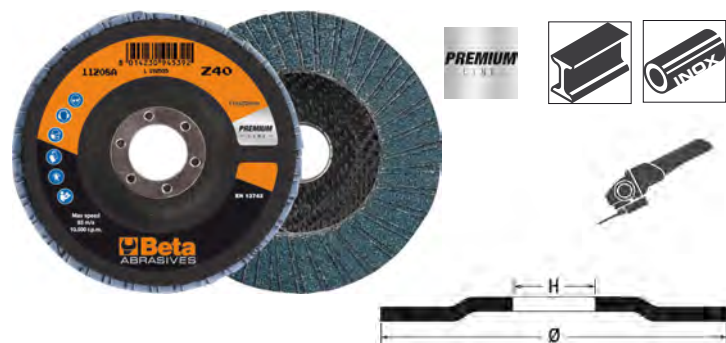

	Ø mm	P mm	F mm	€		
11208A	115	40	22,23	3,10	10	112080004
11208A	115	60	22,23	3,10	10	112080006

	Ø mm	P mm	F mm	€		
11208B	125	40	22,23	3,65	10	112080104
11208B	125	60	22,23	3,65	10	112080106

11210A-11210B

Lamellen slijpschijf met zirkonium schuurmateriaal, glasfiber steunschijf, enkele lamel constructie

Kegelvormig
PREMIUM LIJN
Ø 115 mm
EN 13743



	Ø mm	P mm	F mm	€		
11210A	115	40	22,23	3,10	10	112100004
11210A	115	60	22,23	3,10	10	112100006
11210A	115	80	22,23	3,10	10	112100008
11210A	115	120	22,23	3,10	10	112100012

	Ø mm	P mm	F mm	€		
11210B	125	40	22,23	3,65	10	112100104
11210B	125	60	22,23	3,65	10	112100106
11210B	125	80	22,23	3,65	10	112100108

11212A-11212B

Lamellen slijpschijf met zirkonium schuurmateriaal, kunststof steunschijf, enkele lamel constructie

Vlak
TOP LIJN
Ø 115 mm
EN 13743

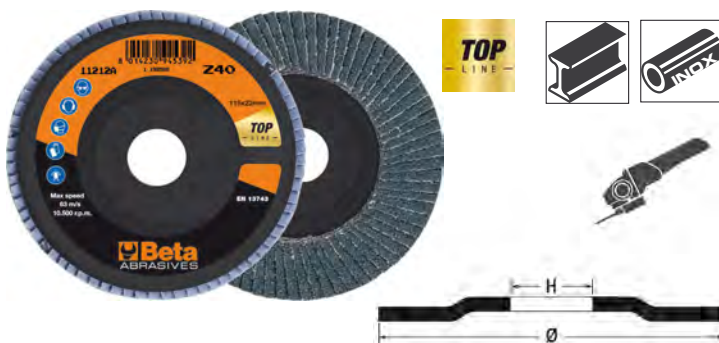

	Ø mm	P mm	F mm	€		
11212A	115	40	22,23	3,85	10	112120004
11212A	115	60	22,23	3,85	10	112120006
11212A	115	80	22,23	3,85	10	112120008
11212A	115	120	22,23	3,85	10	112120012

	Ø mm	P mm	F mm	€		
11212B	125	40	22,23	4,80	10	112120104
11212B	125	60	22,23	4,80	10	112120106
11212B	125	80	22,23	4,80	10	112120108

Beta

11214A-11214C

Lamellen slijpschijf met zirkonium schuurmateriaal, kunststof steunschijf, dubbele lamel constructie

Vlak
TOP LIJN
Ø 115 mm
EN 13743

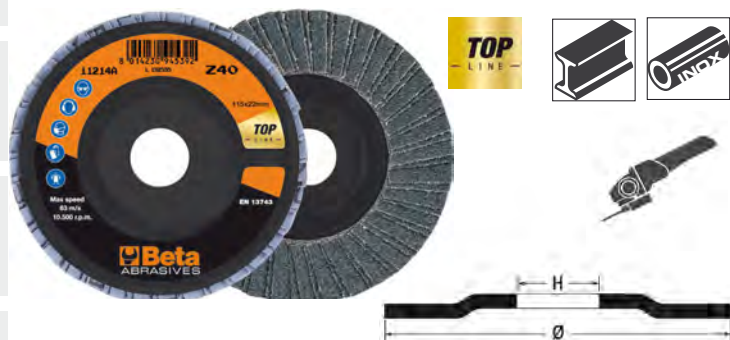

	Ø mm	P	F mm	€		
11214A	115	40	22,23	3,85	10	112140004
11214A	115	60	22,23	3,85	10	112140006
11214A	115	80	22,23	3,85	10	112140008
11214A	115	120	22,23	3,85	10	112140012

	Ø mm	P	F mm	€		
11214B	125	40	22,23	4,80	10	112140104
11214B	125	60	22,23	4,80	10	112140106
11214B	125	80	22,23	4,80	10	112140108

	Ø mm	P	F mm	€		
11214C	180	40	22,23	9,95	10	112140204
11214C	180	60	22,23	9,95	10	112140206

11216A-11216B

Lamellen slijpschijf met zirkonium schuurmateriaal, glasfiber steunschijf, enkele lamel constructie

Vlak
TOP LIJN
Ø 115 mm
EN 13743



	Ø mm	P	F mm	€		
11216A	115	40	22,23	3,85	10	112160004
11216A	115	60	22,23	3,85	10	112160006
11216A	115	80	22,23	3,85	10	112160008
11216A	115	120	22,23	3,85	10	112160012

	Ø mm	P	F mm	€		
11216B	125	40	22,23	4,85	10	112160104
11216B	125	60	22,23	4,85	10	112160106
11216B	125	80	22,23	4,85	10	112160108

11218A-11218B

Lamellen slijpschijf met zirkonium schuurmateriaal, glasfiber steunschijf, dubbele lamel constructie

Vlak
TOP LIJN
Ø 115 mm
EN 13743



	Ø mm	P	F mm	€		
11218A	115	40	22,23	3,85	10	112180004
11218A	115	60	22,23	3,85	10	112180006

	Ø mm	P	F mm	€		
11218B	125	40	22,23	4,85	10	112180104
11218B	125	60	22,23	4,85	10	112180106

11220A-11220B

Lamellen slijpschijf met zirkonium schuurmateriaal, glasfiber steunschijf, enkele lamel constructie

Kegelvormig
TOP LIJN
Ø 115 mm
EN 13743



	Ø mm	P	F mm	€		
11220A	115	40	22,23	3,85	10	112200004
11220A	115	60	22,23	3,85	10	112200006
11220A	115	80	22,23	3,85	10	112200008
11220A	115	120	22,23	3,85	10	112200012

	Ø mm	P	F mm	€		
11220B	125	40	22,23	4,70	10	112200104
11220B	125	60	22,23	4,70	10	112200106
11220B	125	80	22,23	4,70	10	112200108

Beta

11222B

Lamellenschijven belegd met zirkonium schuurmateriaal, glasvezel steunpad, dubbele lamellen constructie

Conisch gevormd
TOP LINE
Ø 115 mm
EN 13743

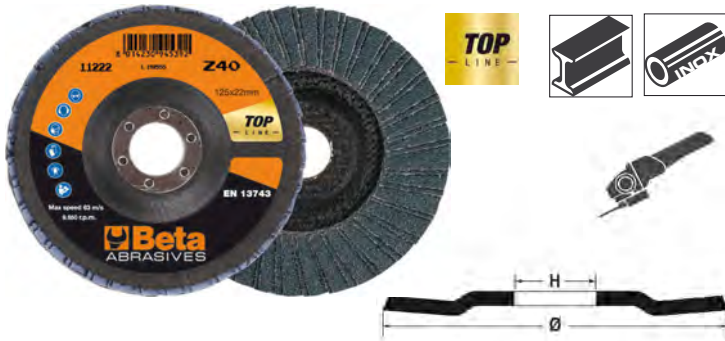

	Ø mm	P	F mm	€		
11222B	125	40	22,23	4,70	10	112220104
11222B	125	60	22,23	4,70	10	112220106
11222B	125	80	22,23	4,70	10	112220108

11230A-11230B

Lamellen slijpschijf met korund schuurmateriaal, kunststof steunschijf, enkele lamel constructie

Vlak
PREMIUM LIJN
Ø 115 mm
EN 13743



	Ø mm	P	F mm	€		
11230A	115	40	22,23	2,91	10	112300004
11230A	115	60	22,23	2,91	10	112300006
11230A	115	80	22,23	2,91	10	112300008
11230A	115	120	22,23	2,91	10	112300012
11230B	125	40	22,23	3,55	10	112300104
11230B	125	60	22,23	3,55	10	112300106

Beta

11232A

Lamellen slijpschijf met korund schuurmateriaal, kunststof steunschijf, dubbele lamel constructie

Vlak
PREMIUM LIJN
Ø 115 mm
EN 13743

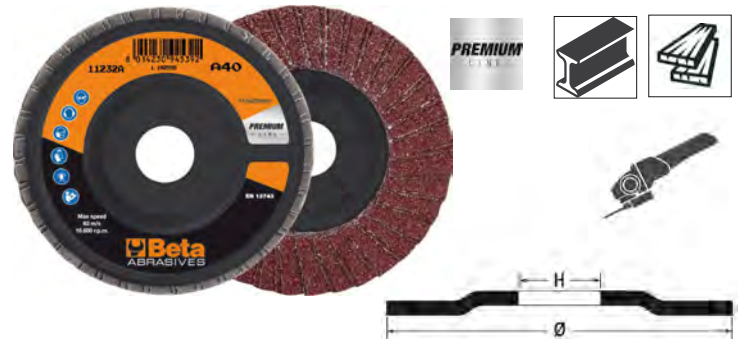

	Ø mm	P	F mm	€		
11232A	115	40	22,23	2,91	10	112320004
11232A	115	60	22,23	2,91	10	112320006
11232A	115	80	22,23	2,91	10	112320008
11232A	115	120	22,23	2,91	10	112320012

11234A

Lamellen slijpschijf met korund schuurmateriaal, glasfiber steunschijf, enkele lamel constructie

Vlak
TOP LIJN
Ø 115 mm
EN 13743

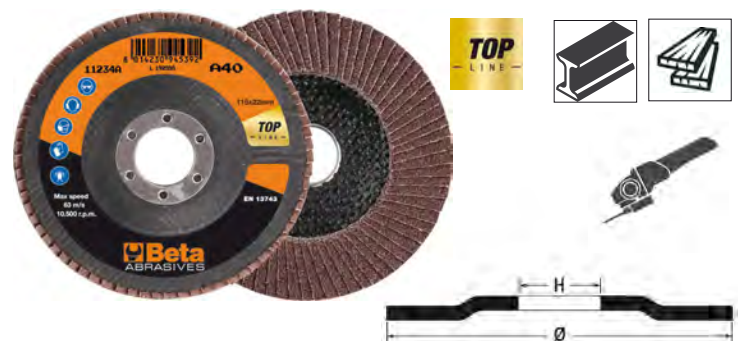

	Ø mm	P	F mm	€		
11234A	115	40	22,23	3,45	10	112340004
11234A	115	60	22,23	3,45	10	112340006
11234A	115	80	22,23	3,45	10	112340008
11234A	115	120	22,23	3,45	10	112340012

Beta

11240A-11240B

Lamellen slijpschijf met keramische gelaagde zirkonium schuurmateriaal, kunststof steunschijf, enkele lamel constructie

Vlak
Ø 115 mm
EN 13743



	Ø mm	P	F mm	€		
11240A	115	40	22,23	5,60	10	112400004
11240A	115	60	22,23	5,60	10	112400006

	Ø mm	P	F mm	€		
11240B	125	40	22,23	7,00	10	112400104
11240B	125	60	22,23	7,00	10	112400106

11242A-11242B

Lamellen slijpschijf met keramische gelaagde zirkonium schuurmateriaal, glasfiber steunschijf, enkele lamel constructie

Vlak
Ø 115 mm
EN 13743

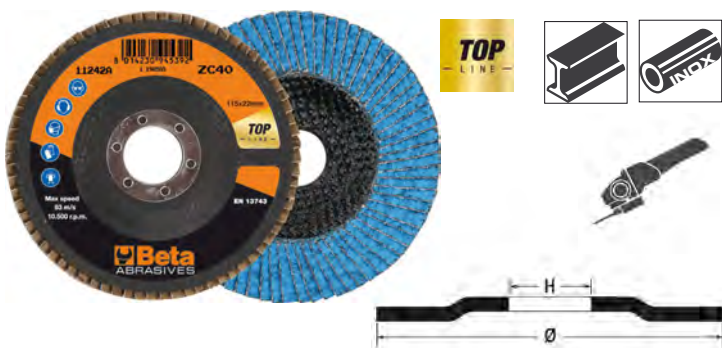

	Ø mm	P	F mm	€		
11242A	115	40	22,23	5,55	10	112420004
11242A	115	60	22,23	5,55	10	112420006

	Ø mm	P	F mm	€		
11242B	125	40	22,23	6,60	10	112420104
11242B	125	60	22,23	6,60	10	112420106

11246A

Lamellen slijpschijf met keramische gelaagd schuurmateriaal, kunststof steunschijf, enkele lamel constructie

Vlak
Ø 115 mm
EN 13743



	Ø mm	P	F mm	€		
11246A	115	40	22,23	6,95	10	112460004
11246A	115	60	22,23	6,95	10	112460006

11248A-11248B

Lamellen slijpschijf met keramische gelaagd schuurmateriaal, glasfiber steunschijf, enkele lamel constructie

Vlak
Ø 115 mm
EN 13743



	Ø mm	P	F mm	€		
11248A	115	40	22,23	6,90	10	112480004
11248A	115	60	22,23	6,90	10	112480006

	Ø mm	P	F mm	€		
11248B	125	40	22,23	8,60	10	112480104
11248B	125	60	22,23	8,60	10	112480106

11259

Lamellenschijven, glasvezel steunpad, enkele lamel constructie

Vlak



	Ø mm	F mm	€		
11259	115	22,23	11,20	10	112590115
11259	125	22,23	12,70	10	112590125

Beta

11260÷11268

Lamellen slijpborstel,
lamellen belegd met korund schuurmateriaal

As Ø 3 mm

EN 13743



	Ø mm	h mm	S mm	P	€		
11260	10	10	3	60	5,45	10	112600010
11260	15	15	3	60	4,30	10	112600015

	Ø mm	h mm	S mm	P	€		
11263	30	10	6	60	2,88	10	112630006
11263	30	15	6	60	2,88	10	112630016
11263	30	15	6	80	2,88	10	112630018
11263	30	20	6	40	2,91	10	112630024
11263	30	20	6	60	3,10	10	112630026
11263	30	20	6	80	3,10	10	112630028
11263	30	20	6	120	3,10	10	112630032

	Ø mm	h mm	S mm	P	€		
11264	40	15	6	60	3,00	10	112640006
11264	40	15	6	80	3,00	10	112640008
11264	40	15	6	120	3,00	10	112640012
11264	40	20	6	40	3,25	10	112640014
11264	40	20	6	60	3,25	10	112640016
11264	40	30	6	40	3,70	10	112640024
11264	40	30	6	60	3,70	10	112640026

	Ø mm	h mm	S mm	P	€		
11265	50	20	6	60	3,75	10	112650006
11265	50	20	6	80	3,75	10	112650008
11265	50	30	6	40	4,25	10	112650014
11265	50	30	6	60	4,25	10	112650016
11265	50	30	6	80	4,25	10	112650018
11265	50	30	6	120	4,45	10	112650022

	Ø mm	h mm	S mm	P	€		
11266	60	20	6	40	4,45	10	112660004
11266	60	20	6	60	4,45	10	112660006
11266	60	30	6	40	5,00	10	112660014
11266	60	30	6	60	5,00	10	112660016
11266	60	30	6	80	5,00	10	112660018
11266	60	30	6	120	5,45	10	112660022
11266	60	40	6	60	5,75	10	112660026
11266	60	40	6	80	5,75	10	112660028

	Ø mm	h mm	S mm	P	€		
11268	80	30	6	60	6,90	10	112680006
11268	80	30	6	80	6,90	10	112680008

Beta

11271A÷11271C

schuurvlies slijpborstel,
korund synthetisch fiber schuurmateriaal

Ø 40 mm

as Ø 6 mm



	Ø mm	h mm	S mm	P	€		
11271A	40	20	6	C	7,25	10	112710001
11271A	40	20	6	M	7,25	10	112710002
11271A	40	20	6	F	7,25	10	112710003
11271A	40	20	6	VF	7,25	10	112710004

	Ø mm	h mm	S mm	P	€		
11271B	60	30	6	C	8,10	10	112710011
11271B	60	30	6	M	8,10	10	112710012
11271B	60	30	6	F	8,10	10	112710013
11271B	60	30	6	VF	8,10	10	112710014

	Ø mm	h mm	S mm	P	€		
11271C	80	50	6	C	9,05	10	112710021
11271C	80	50	6	M	9,05	10	112710022
11271C	80	50	6	F	9,05	10	112710023
11271C	80	50	6	VF	9,05	10	112710024

11276A÷11276C

Lamellen schuurvlies stiftborstel,
Lamellen vervaardigd uit schuurmateriaal afwisselend voorzien van
korund synthetisch fiber

Ø 40 mm

as Ø 6 mm



	Ø mm	h mm	S mm	P	€		
11276A	40	20	6	M/60	8,20	10	112760006
11276A	40	20	6	M/80	8,20	10	112760008
11276A	40	20	6	M/120	8,20	10	112760012

	Ø mm	h mm	S mm	P	€		
11276B	60	30	6	M/60	8,90	10	112760016
11276B	60	30	6	M/80	8,90	10	112760018
11276B	60	30	6	M/120	8,90	10	112760022

Beta

	Ø mm	h mm	S mm	P	€		
11276C	80	50	6	M/60	10,70	10	112760036
11276C	80	50	6	M/80	10,70	10	112760038
11276C	80	50	6	M/120	10,70	10	112760042

11300A÷11300G

Lamellen slijpwiël belegd met korund, met asgat

Ø 165 x 30 mm

EN 13743

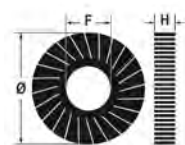

	Ø mm	H mm	P	F mm	€		
11300A	165	30	40	54	30,00	3	113000004
11300A	165	30	60	54	30,50	3	113000006
11300A	165	30	80	54	32,50	3	113000008
11300A	165	30	120	54	35,50	3	113000012
11300A	165	30	180	54	37,00	3	113000018
11300A	165	30	220	54	38,50	3	113000022

	Ø mm	H mm	P	F mm	€		
11300B	165	50	40	54	41,00	2	113000104
11300B	165	50	60	54	43,00	2	113000106
11300B	165	50	80	54	45,00	2	113000108
11300B	165	50	120	54	49,00	2	113000112
11300B	165	50	180	54	54,50	2	113000118
11300B	165	50	220	54	57,50	2	113000122

	Ø mm	H mm	P	F mm	€		
11300C	200	30	40	54	36,50	3	113000204
11300C	200	30	60	54	37,50	3	113000206
11300C	200	30	80	54	41,00	3	113000208
11300C	200	30	120	54	43,00	3	113000212
11300C	200	30	180	54	47,00	3	113000218

	Ø mm	H mm	P	F mm	€		
11300D	200	50	40	54	48,50	2	113000304
11300D	200	50	60	54	54,50	2	113000306
11300D	200	50	80	54	57,50	2	113000308
11300D	200	50	120	54	64,50	2	113000312
11300D	200	50	180	54	68,50	2	113000318
11300D	200	50	220	54	74,50	2	113000322

	Ø mm	H mm	P	F mm	€		
11300E	250	30	40	100	63,00	3	113000404
11300E	250	30	60	100	67,50	3	113000406
11300E	250	30	80	100	68,50	3	113000408
11300E	250	30	120	100	72,00	3	113000412

	Ø mm	H mm	P	F mm	€		
11300F	250	50	40	100	91,50	2	113000504
11300F	250	50	60	100	92,50	2	113000506
11300F	250	50	80	100	94,50	2	113000508
11300F	250	50	120	100	99,50	2	113000512
11300F	250	50	180	100	116,50	2	113000518
11300F	250	50	220	100	127,50	2	113000522

	Ø mm	H mm	P	F mm	€		
11300G	300	50	40	100	122,50	2	113000604
11300G	300	50	60	100	127,50	2	113000606
11300G	300	50	80	100	131,50	2	113000608

11320

Reinigingsschijf met asgat,
korund synthetisch fiber materiaal

Ø 200 x 50 mm

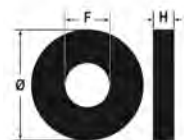
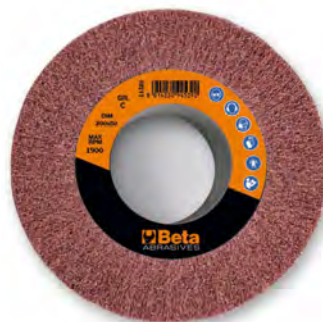

	Ø mm	H mm	P	F mm	€		
11320	200	50	C	76,2	37,00	2	113200006
11320	200	50	M	76,2	37,00	2	113200008
11320	200	50	F	76,2	37,00	2	113200012
11320	200	50	VF	76,2	37,00	2	113200024

11411

Lamellen slijpborstel belegd met
korundschuurmateriaal voor satineermachines

Ø 100 x 100 mm

EN 13743



	Ø mm	H mm	P	F mm	€		
11411	100	100	40	19,1	31,00	2	114110004
11411	100	100	60	19,1	35,00	2	114110006
11411	100	100	80	19,1	36,50	2	114110008
11411	100	100	120	19,1	37,00	2	114110012
11411	100	100	240	19,1	38,00	2	114110024

11415B

Schuurvliesborstel vervaardigd uit korund synthetisch fiber
schuurmateriaal voor satineermachines

Ø 100 x 100 mm



	Ø mm	H mm	P	F mm	€		
11415B	100	100	C	19,1	26,00	2	114150106
11415B	100	100	M	19,1	26,00	2	114150108
11415B	100	100	F	19,1	26,00	2	114150112
11415B	100	100	VF	19,1	26,00	2	114150124

11420B

Lamellen schuurvlies stiftborstel,
Lamellen vervaardigd uit schuurmateriaal afwisselend voorzien van
korund synthetisch fiber

Ø 100 x 100 mm

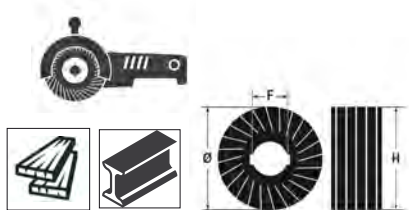

	Ø mm	H mm	P	F mm	€		
11420B	100	100	C/60	19,1	28,50	2	114200106
11420B	100	100	M/80	19,1	28,50	2	114200108
11420B	100	100	F/120	19,1	28,50	2	114200112
11420B	100	100	VF/240	19,1	28,50	2	114200124

11431

Reinigingsschijf,
belegd met korund synthetisch fiber

Ø 115 mm



	Ø mm	P	F mm	€		
11431	115	C	22,23	15,40	4	114310006
11431	115	M	22,23	15,40	4	114310008
11431	115	F	22,23	15,40	4	114310012
11431	115	VF	22,23	15,40	4	114310024

11440A÷11440C

Fiberschuur schijf belegd met zirkonium schuurmateriaal

Ø 115 mm

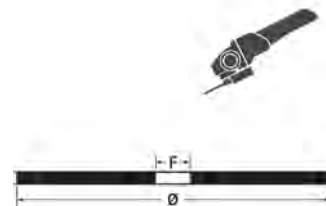

	Ø mm	P	F mm	€		
11440A	115	24	22	1,42	25	114400024
11440A	115	36	22	1,42	25	114400036
11440A	115	60	22	1,34	25	114400060
11440A	115	120	22	1,34	25	114400120

	Ø mm	P	F mm	€		
11440B	125	24	22	1,70	25	114400224
11440B	125	36	22	1,70	25	114400236
11440B	125	60	22	1,62	25	114400260
11440B	125	120	22	1,62	25	114400320

	Ø mm	P	F mm	€		
11440C	180	24	22	2,63	25	114400424
11440C	180	36	22	2,63	25	114400436
11440C	180	60	22	2,53	25	114400460
11440C	180	120	22	2,53	25	114400520

11450A÷11450C

Fiberschuur schijf belegd met korund schuurmateriaal

Ø 115 mm

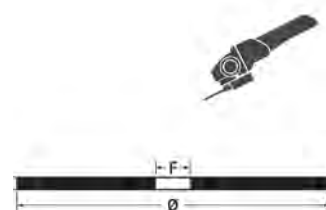

	Ø mm	P	F mm	€		
11450A	115	24	22	1,11	25	114500024
11450A	115	36	22	1,11	25	114500036
11450A	115	60	22	1,01	25	114500060
11450A	115	120	22	1,01	25	114500120

	Ø mm	P	F mm	€		
11450B	125	24	22	1,23	25	114500224
11450B	125	36	22	1,23	25	114500236
11450B	125	60	22	1,22	25	114500260
11450B	125	120	22	1,22	25	114500320

	Ø mm	P	F mm	€		
11450C	180	24	22	1,90	25	114500424
11450C	180	36	22	1,90	25	114500436
11450C	180	60	22	1,78	25	114500460
11450C	180	120	22	1,78	25	114500520

Beta

11488PF

Steunpads voor fiberschuurschijf met opsluitmoer M14



	Ø mm	€		
11488P	115	8,60	1	114880115
11488P	125	9,40	1	114880125
11488P	180	14,40	1	114880180

11491-11493-11495

Schuurvliesrol vervaardigd uit korund schuurmateriaal

h 38 mm x 50 m



	H mm	L m	P	€		
11491	38	50	40	54,50	1	114910004
11491	38	50	60	53,50	1	114910006
11491	38	50	80	52,00	1	114910008
11491	38	50	100	50,50	1	114910010
11491	38	50	120	50,50	1	114910012
11491	38	50	150	50,50	1	114910015
11491	38	50	180	50,50	1	114910018
11491	38	50	220	50,50	1	114910022
11491	38	50	240	50,50	1	114910024
11491	38	50	320	50,50	1	114910032
11491	38	50	400	50,50	1	114910040

	H mm	L m	P	€		
11493	50	50	40	84,00	1	114930004
11493	50	50	60	78,50	1	114930006
11493	50	50	80	78,00	1	114930008
11493	50	50	100	73,00	1	114930010
11493	50	50	120	73,00	1	114930012
11493	50	50	150	73,00	1	114930015
11493	50	50	180	73,00	1	114930018
11493	50	50	220	73,00	1	114930022
11493	50	50	240	73,00	1	114930024
11493	50	50	320	73,00	1	114930032
11493	50	50	400	73,00	1	114930040

	H mm	L m	P	€		
11495	120	25	40	101,50	1	114950004
11495	120	25	60	99,00	1	114950006
11495	120	25	80	95,00	1	114950008
11495	120	25	100	94,00	1	114950010
11495	120	25	120	94,00	1	114950012
11495	120	25	180	94,00	1	114950018
11495	120	25	240	94,00	1	114950024
11495	120	25	400	94,00	1	114950040

11498

Ongeweven schuurvliesrol met korund synthetisch fiber

h 100 mm x 10 m



	H mm	L m	P	€		
11498	100	10	M	46,00	1	114980008
11498	100	10	F	37,00	1	114980012
11498	100	10	VF	37,00	1	114980015
* 11498	100	10	UF	39,50	1	114980018



KABELSCHOENTANGEN VOOR NIET-GEÏSOLEERDE EN GEÏSOLEERDE KABELUITEINDEN

		Terminals	Matrijsdiepte	Range (mm ²)	Toepassing
1601/PC					Voor telefoon- en datatransmissieterminals 4P / 6P / 8P
1602				0,75-6	Voor geïsoleerde klemmen, lichte serie
1602A				0-6	Voor geïsoleerde klemmen, standaardmodel
1603				1,25-5,5	Voor niet-geïsoleerde klemmen, lichte serie
1603A				0-8	Voor niet-geïsoleerde gesloten klemmen, standaardmodel
1603B				0-8	Voor niet-geïsoleerde open klemmen, standaardmodel
1606/2				0,14-10	Heavy-duty, voor cilindrische terminals
1606A				0,5-6 6-16	Voor cilindrische terminals
1606T				0,1-10	Voor cilindrische terminals, 4-zijdig krimpen
1607				6,48 5,41 1,69	Heavy-duty, voor BNC-coaxdraden RG 58, RG 59, RG 62, RG 71
1608				0,5-6	Voor geïsoleerde klemmen, met drukregeling
1608A				0,75-6	Heavy-duty, voor geïsoleerde terminals
1609				0,5-2,5	Voor niet-geïsoleerde terminals
1609A				0,5-6	Heavy-duty, voor niet-geïsoleerde terminals
1609B				10-120	Voor niet-geïsoleerde terminals



1601/PC

Kabelschoentang voor telefoonterminals en data transmissie



RJ11-RJ12-RJ45

€ 74,50

2 016010011

1602

Kabelschoentang voor geïsoleerde kabelschoenen lichte uitvoering

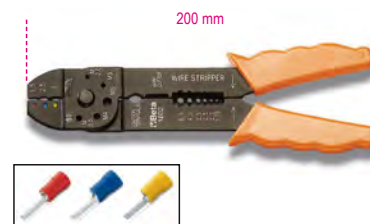

mm²
0,75÷6

€ 15,00

5 016020001

1602/C9

Kabelschoentang, lichte uitvoering met een assortiment van 450 terminals



1602/C9

€ 155,00

1 016020045

1602

BM00180 R/6,3
BM00280 B/6,3
BM00380 G/6,3
BM00191 R/6,3
BM00291 B/6,3
BM00392 G/6,3
BM00160 R/1,6
BM00260 B/2,3
BM00360 G/3,6

n.
1
50
50
50
50
50
50
50
50
50

420x185x60 mm - 1,5 kg

1602A

Kabelschoentang voor geïsoleerde kabelschoenen



mm² 0÷6 € 70,50 2 016020005

1603

Kabelschoentang voor niet-geïsoleerde kabelschoenen lichte uitvoering

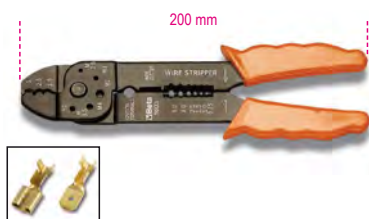

mm² 1,25÷5,5 € 16,00 5 016030001

1603A

Kabelschoentang voor niet-geïsoleerde gesloten kabelschoenen

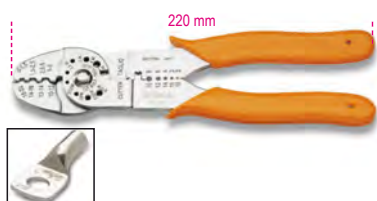

mm² 0÷8 € 70,50 2 016030005

1603B

Kabelschoentang voor niet-geïsoleerde open kabelschoenen

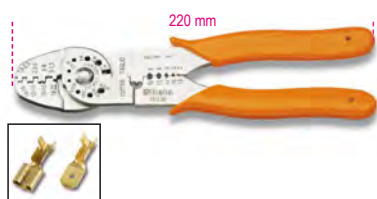

mm² 0÷8 € 72,50 2 016030010



1606/2

Kabelschoentang voor adereindhulzen, zware uitvoering



mm² 0,14÷10 L 175 A 65 B 20 € 423,00 1 016060002

1606A

Kabelschoentang voor ronde kabelschoenen



mm² 0,5÷6 € 106,50 1 016060010
1606A16 6÷16 € 106,50 1 016060016

1606A/C9

Kabelschoentang voor ronde terminals met een 450-delig assortiment terminals, 0,5÷6 mm²



1606A/C9 € 177,50 1 016060045

1606A6		n.
BM00601	W/0,5	50
BM00604	N/1,5	100
BM00506	B/2,5	100
BM00508	G/4	100
BM00610	Y/6	100

420x185x60 mm - 2,5 kg



Beta

1606T

Kabelschoentang voor adereindhulzen, vierkant verkrimping

Gereduceerde krachtinspanning



mm² 0,1÷10 L 173 A 61 B 13 € 375,00 1 016060005

1607

Industriële kabelschoentang voor BNC coaxkabels RG 58, RG 59, RG 62, RG 71



1607 L 220 A 73 B 19 € 369,00 1 016070001

1608

Kabelschoentang voor geïsoleerde kabelschoenen met regelbare druk.

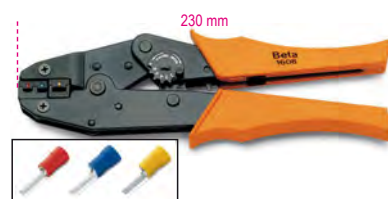

mm² 0,5÷6 € 138,50 1 016080001

1608/C9

Kabelschoentang met een 450-delig assortiment



1608/C9 € 278,00 1 016080045

1608	n.
BM00180 R/6,3	50
BM00280 B/6,3	50
BM00380 G/6,3	50
BM00191 R/6,3	50
BM00291 B/6,3	50
BM00392 G/6,3	50
BM00160 R/1,6	50
BM00260 B/2,3	50
BM00360 G/3,6	50

420x185x60 mm - 2 kg

1608A

Industriële kabelschoentang voor geïsoleerde kabelschoenen



mm² 0,75÷6 € 291,00 1 016080005

Beta

1609

Kabelschoentang voor niet-geïsoleerde kabelschoenen professioneel model



mm² 0,5÷2,5 € 138,50 1 016090001

1609A

Industriële kabelschoentang voor niet-geïsoleerde kabelschoenen



mm² 0,5÷6 € 569,00 1 016090005

1609B

Kabelschoentang voor niet-geïsoleerde kabelschoenen krimpcapaciteit, 10 mm² ÷ 120 mm²



L mm 600 mm² 10÷120 € 383,00 1 016090101

1609C/C5

Hydraulische kabelschoentang 1609 met 5 paar matrijzen

Zeskante krimp, 25 mm² ÷ 240 mm²



mm² 50÷240 € 2.295,00 1 016090210
500x300x110 mm - 4 kg

1609M

Matrijzen voor item 1609C

zeskant krimp



	mm ²	€		
1609M/16	10-16	87,00	1	016090221
1609M/35	25-35	87,00	1	016090223
1609M/70	50-70	87,00	1	016090225
1609M/120	95-120	87,00	1	016090227
1609M/150	150	87,00	1	016090229
1609M/185	185	87,00	1	016090231
1609M/240	240	87,00	1	016090233

1639S

Nylon draadtrekker

Met verwisselbare bekken



L m 10 Ø mm 4 € 23,80 1 016390010



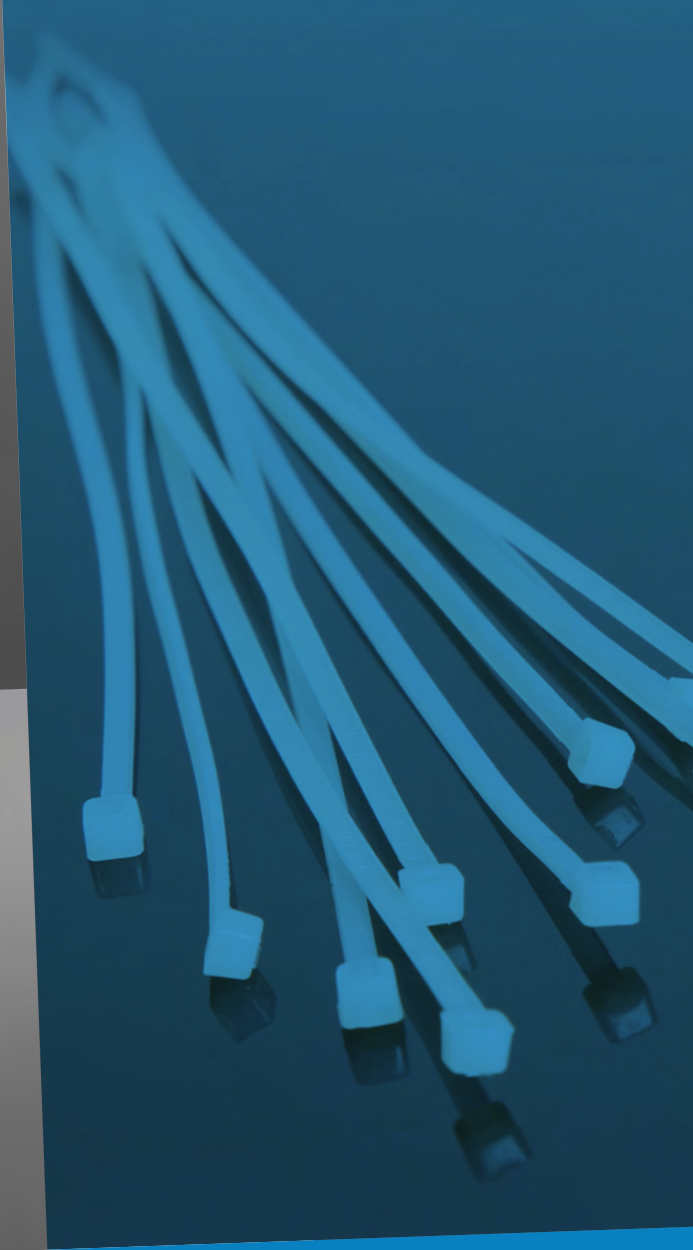
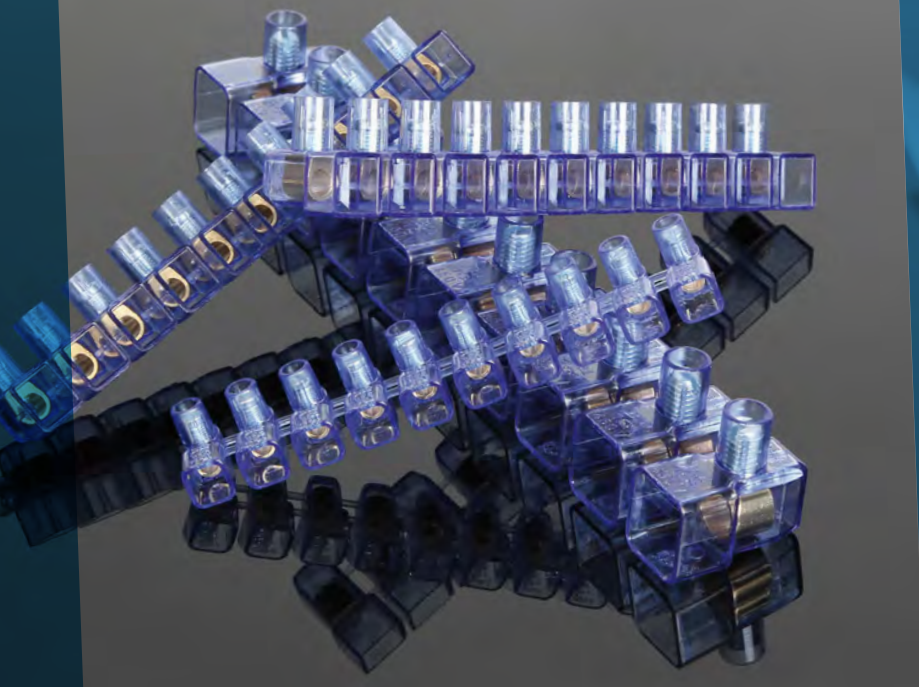

PRODUCTEN ONDER DE MERKNAMEN BM; BINDSTRIPS, KABELSCHOENEN, ISOLATIETAPE

BM Group ontwerpt, produceert en distribueert verbindingdelen en elektrische installatieproducten sinds 1958. Kwaliteit, veiligheid en betrouwbaarheid zijn altijd de kernwaarden van BM geweest. In combinatie met een passie voor excellentie hebben deze waarden het bedrijf in staat gesteld om zich stap voor stap te ontwikkelen tot een benchmark voor de markt voor elektrisch materiaal.

In 2018 werd BM Group overgenomen door Beta Utensili. Dit gedeelte bevat een nauwkeurige selectie van producten onder de merknaam BM, als aanvulling op het assortiment van Beta.

CERTIFIED QUALITY



1610-B

Ringkabelschoen

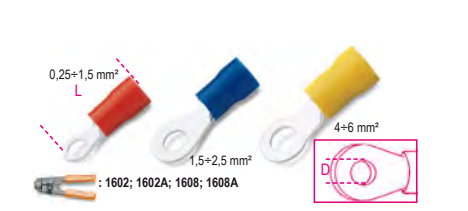

0,25+1,5 mm² L
1,5+2,5 mm²
4+6 mm²

: 1602; 1602A; 1608; 1608A

D mm	mm ²	L mm	€	100	BM00119
4	0,25-1,5	20,6	8,65	100	BM00119
5	0,25-1,5	21,8	8,55	100	BM00125
5	1,5-2,5	22,4	8,70	100	BM00225
6	1,5-2,5	26	9,75	100	BM00231
8	1,5-2,5	29,8	11,60	100	BM00237
6	4-6	29,1	15,30	50	BM00331
8	4-6	34,5	18,70	50	BM00337

- Geef a.u.b het aantal van de terminals en niet het aantal verpakking aan in uw bestelling
- Afgebeelde prijzen zijn per 100 stuks

1614-P

Penstekers

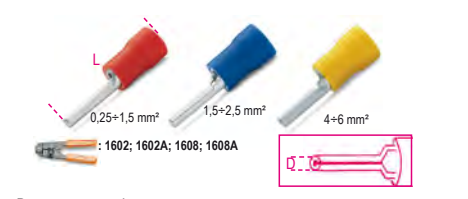

0,25+1,5 mm² L
1,5+2,5 mm²
4+6 mm²

: 1602; 1602A; 1608; 1608A

D mm	mm ²	L mm	€	100	BM00151
1,9	0,25-1,5	19	8,95	100	BM00151
1,9	1,5-2,5	19	8,95	100	BM00251
2,7	4-6	28	15,10	50	BM00350

- Geef a.u.b het aantal van de terminals en niet het aantal verpakking aan in uw bestelling
- Afgebeelde prijzen zijn per 100 stuks

1616-SM

Rondsteker

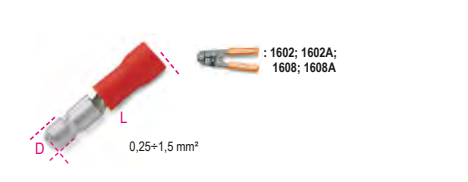

0,25+1,5 mm² L

: 1602; 1602A; 1608; 1608A

D mm	mm ²	L mm	€	100	BM00130
4	0,25-1,5	21	17,00	100	BM00130

- Please indicate number of terminals, and not of packages, in your order
- Stated prices are for 100 pieces

1618-SF

Geïsoleerde rondstekerhuls



1618R/4K
0,25+1,5 mm² L

: 1602; 1602A; 1608; 1608A

D mm	mm ²	L mm	€	100	BM00140
3,8	0,25-1,5	23,5	19,70	100	BM00140

- Geef a.u.b het aantal van de terminals en niet het aantal verpakking aan in uw bestelling
- Afgebeelde prijzen zijn per 100 stuks

1620-M

Geïsoleerde vlaksteker

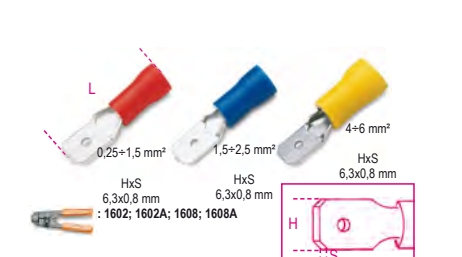

0,25+1,5 mm² L
1,5+2,5 mm²
4+6 mm²

HxS mm mm² mm
6,3x0,8 6,3x0,8 mm
: 1602; 1602A; 1608; 1608A

HxS mm	mm ²	L mm	€	100	BM00180
6,3x0,8	0,25-1,5	21	16,30	100	BM00180
6,3x0,8	1,5-2,5	21	17,00	100	BM00280
6,3x0,8	4-6	24,5	18,50	50	BM00380

- Geef a.u.b het aantal van de terminals en niet het aantal verpakking aan in uw bestelling
- Afgebeelde prijzen zijn per 100 stuks

1622-F

Vlakstekerhuls

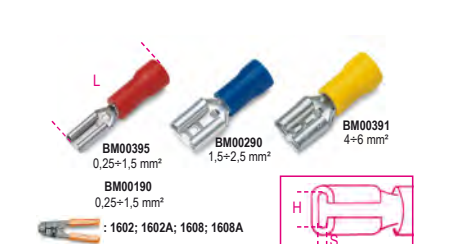

BM00395
0,25+1,5 mm²
BM00290
1,5+2,5 mm²
BM00391
4+6 mm²

: 1602; 1602A; 1608; 1608A

HxS mm	mm ²	L mm	€	100	BM00190
6,3x0,8	0,25-1,5	20,7	16,60	100	BM00190
2,8x0,5	0,25-1,5	18,5	13,90	100	BM00395
6,3x0,8	1,5-2,5	20,7	17,00	100	BM00290
6,3x0,8	4-6	24,5	24,00	50	BM00391

- Geef a.u.b het aantal van de terminals en niet het aantal verpakking aan in uw bestelling
- Afgebeelde prijzen zijn per 100 stuks

1624-FI

Geïsoleerde vlakstekerhuls

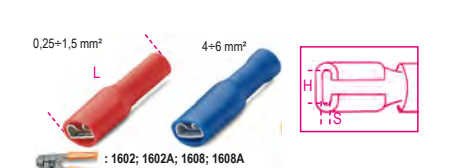

0,25+1,5 mm² L
4+6 mm²

: 1602; 1602A; 1608; 1608A

HxS mm	mm ²	L mm	€	100	BM00191
6,3x0,8	0,25-1,5	22	18,30	100	BM00191
6,3x0,8	1,5-2,5	22	18,60	50	BM00291
6,3x0,8	4-6	25	23,90	50	BM00392

- Geef a.u.b het aantal van de terminals en niet het aantal verpakking aan in uw bestelling
- Afgebeelde prijzen zijn per 100 stuks

1628-C

Stootverbinder

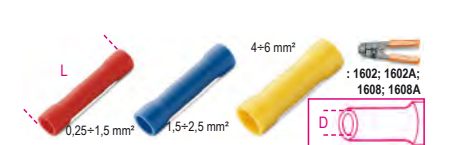

0,25+1,5 mm² L
1,5+2,5 mm²
4+6 mm²

: 1602; 1602A; 1608; 1608A

D mm	mm ²	L mm	€	100	BM00160
1,8	0,25-1,5	25	13,80	100	BM00160
2,5	1,5-2,5	26,5	16,30	100	BM00260
3,7	4-6	27	23,30	50	BM00360

- Geef a.u.b het aantal van de terminals en niet het aantal verpakking aan in uw bestelling
- Afgebeelde prijzen zijn per 100 stuks

1630-CR

Afakklemmen



0,25+1 mm² L
1,25+2,5 mm²

mm ²	L mm	€	500	BM00110
0,25-1	15,3	14,20	500	BM00110
1,25-2,5	15,9	13,70	500	BM00210

- Geef a.u.b het aantal van de terminals en niet het aantal verpakking aan in uw bestelling
- Afgebeelde prijzen zijn per 100 stuks

1632-TS

Enkelvoudige adereindhuls



L

mm ²	L mm	€	500	BM00601
0,5	14	1,72	500	BM00601
0,75	14	1,72	500	BM00602
1	14	1,72	500	BM00603
1,5	14	1,72	500	BM00604
2,5	14	2,23	250	BM00506
4	17	3,60	200	BM00508
6	20	5,75	100	BM00610
0,5	14	1,72	500	BM00501
0,75	14	1,72	500	BM00502
1	14	1,72	500	BM00503
1,5	14	1,71	500	BM00504
6	20	5,80	100	BM00510

- Geef a.u.b het aantal van de terminals en niet het aantal verpakking aan in uw bestelling
- Afgebeelde prijzen zijn per 100 stuks

1634-TD

Dubbele adereindhuls



L

mm ²	L mm	€	200	BM00651
2x0,5	15	5,65	200	BM00651
2x0,75	15	4,40	200	BM00652
2x1	15	4,40	200	BM00654
2x1,5	16	4,70	200	BM00656
2x2,5	18,5	5,35	100	BM00558
2x4	23	15,90	100	BM00560
2x6	26	20,60	50	BM00661
2X0,5	15	5,70	200	BM00551
2X0,75	15	4,45	200	BM00552
2X1	15	4,45	200	BM00554
2X1,5	16	4,70	200	BM00556
2X6	26	20,60	50	BM00561

- Geef a.u.b het aantal van de terminals en niet het aantal verpakking aan in uw bestelling
- Afgebeelde prijzen zijn per 100 stuks





1635-D

Terminal strip, 12 Poles

Isolerende behuizing: natuurlijk polypropyleen (PP)

Geleidend lichaam: messing

Vaste schroef: gegalvaniseerd staal

Zelfdovend: EN 60335-1: 2002+A2:2006 (par. 30.2.3), EN 60695-2-10 bij 850 °C, EN 60695-2-11

Bedrijfstemperatuur: max. 85 °C

Beschermingsgraad: IP20

Referentienormen: EN 60998-1: 2004, EN 60998-2-1: 2004, EN 60335-1: 2002 + A2: 2006 (par. 30.2.3), IEC/EN 60695-2-11

CE



mm ²	L mm	L1 mm	mm ²	€	100	BM
16	93,7	14,7	2,5	1,53	50	BM9200
20,5	116,5	17,2	4	1,89	50	BM9201
23,5	139,5	20,1	6	2,76	50	BM9202
25,3	175,5	22,5	16	4,90	25	BM9203
35,2	228	33,5	25	13,30	10	BM9204

1635-S

Kroonklemmenstrook

Insolatie behuizing: transparant polycarbonaat UL94 V0

Geleidend deel: messing

Borgschroef: gegalvaniseerd staal

Zelfdovend: EN60695-2-10 a 850°C, EN 60335-1:2002 +A2:2006, EN60695-2-11

Werktemperatuur: max. 85 °C

Beschermingsklasse: IP20

Referentie standaard: EN60998-1: EN60998-2-1:2004

CE



mm ²	L mm	L1 mm	S mm	mm ²	N	€	100	BM
1.5	15	7.5	14.5	1.5	2	1,40	10	BM991
				0.75	2+3			
2.5	17.5	9	18.2	2.5	2	1,42	10	BM992
				1.5	2+3			
4	21	10.3	20	4	2	1,89	10	BM9924
				2.5	2+3			
6	22.5	11.8	23	6	2	2,18	10	BM993
				4	2+3			
10	26	14.7	26	10	2	3,75	10	BM994
				4	2+4			
16	31.8	18.8	32.2	16	2	8,90	10	BM995
				10	2+3			
				6	2+4			

1635-S

CE



mm ²	L mm	L1 mm	S mm	mm ²	N	€	100	BM
25	36.3	22.5	41.9	25	2	4,15	25	BM9960
				16	2+3			
35	43.5	26.1	49.4	35	2	5,35	25	BM9961
				25	2+3			
				16	2+4			



1748-BV2

Nylon bindstrips,
naturel kleur

Materiaal: polyamide PA 6.6

Ontvlambaarheids klasse: UL 94-V2

Werktemperatuur: -40 °C ÷ +85 °C

Minimum installatie temperatuur: -10 °C

Bestendig tegen chemicaliën: Goed bestendig tegen basisolie, vetten, chloorhoudende reinigingsmiddelen.

Beperkt bestendig tegen zuren. Niet bestand tegen fenol

Referentie standaard: EN 62275:2015-02

Klassificatie: type 1 (EN); type 21 (UL)

CE



A mm	L mm	Ø MAX mm	F MAX N	€	100	BM
2.5	80	14	80	1,43	100	BMB0824
2.5	100	20.5	80	1,35	100	BMB1025
2.5	120	27	80	2,23	100	BMB1225
2.5	160	40	80	2,99	100	BMB1625
2.5	200	52.5	80	3,45	100	BMB2025
3.6	140	33	180	3,60	100	BMB1436
3.6	200	52.5	180	4,85	100	BMB2036
3.6	300	106	180	6,85	100	BMB2936
3.6	370	105	180	10,30	100	BMB3736
4.6	120	24	220	4,60	100	BMB1248
4.6	160	36	220	4,95	100	BMB1648
4.8	188	46	220	6,15	100	BMB1948
4.8	200	50	220	6,00	100	BMB2048
4.8	250	65	220	8,65	100	BMB2548
4.8	300	81	220	9,00	100	BMB3048
4.8	370	103.5	220	11,20	100	BMB3748
4.8	390	110	220	14,50	100	BMB3948
4.8	430	122.5	220	18,80	100	BMB4348
4.8	530	160	220	31,50	100	BMB5348
7.6	150	24	550	16,10	100	BMB1576
7.6	200	51	550	16,10	100	BMB2076
7.6	300	83	550	18,60	100	BMB2976
7.6	370	103.5	550	22,50	100	BMB3776
7.6	450	130.5	550	37,50	100	BMB4576
7.6	540	159	550	47,50	100	BMB5476
7.6	750	226	550	78,50	100	BMB7576
8.8	550	163.5	800	47,00	100	BMB5390
8.8	710	195	800	65,00	100	BMB7190
8.8	780	235.5	800	71,50	100	BMB7890
9.0	430	130.5	800	38,50	100	BMB4390
9.0	810	245	800	87,00	100	BMB8190
9.0	1020	295	800	119,00	100	BMB1090
9.0	1220	375.5	800	150,00	100	BMB1290
9.0	1530	460	800	204,50	100	BMB1590

- Geef a.u.b het aantal van de bindstrips en niet het aantal verpakking aan in uw bestelling

- Afgebeelde prijzen zijn per 100 stuks

1748V

Kabelbinders Nylon, groen

Materiaal: polyamide PA 6.6

Zelfdovende klasse: UL 94-V2

Bedrijfstemperatuur: -40 °C ÷ +85 °C

Minimale installatietemperatuur: -10 °C

Bestendigheid tegen chemicaliën: goed bestand tegen basen, oliën, vetten, chloride-oplosmiddelen. Beperkte weerstand tegen zuren. Niet bestand tegen fenolen

Referentienormen: EN 62275:2015-02

Klassificatie: type 1 (EN); type 21 (UL)"

CE



A mm	L mm	Ø MAX mm	F MAX N	€	100	BM
2.5	100	20.5	80	1,30	100	BMV1025
3.6	140	33	180	3,45	100	BMV1436
4.8	200	50	220	5,75	100	BMV2048
4.8	300	81	220	8,55	100	BMV3048

- Vermeld bij uw bestelling het aantal kabelbinders en niet het aantal verpakkingen

- Genoemde prijzen zijn per 100 stuks

1748N

Nylon bindstrips,
zwart

UV bestendig

Materiaal: polyamide PA 6.6

Ontvlambaarheids klasse: UL 94-V2

Werktemperatuur: -40 °C ÷ +85 °C

Minimum installatie temperatuur: -10 °C

Bestendig tegen chemicaliën: Goed bestendig tegen basisolie, vetten, chloorhoudende reinigingsmiddelen.

Beperkt bestendig tegen zuren. Niet bestand tegen fenol

Referentie standaard: EN 62275:2015-02

Klassificatie: type 1 (EN); type 21 (UL)

CE



A mm	L mm	Ø mm	F MAX N	€	100	BM
2.5	80	14	80	1,43	100	BMN0824
2.5	100	20.5	80	1,35	100	BMN1025
2.5	120	27	80	2,26	100	BMN1225
2.5	160	40	80	2,99	100	BMN1625
2.5	200	52.5	80	3,45	100	BMN2025
3.6	140	33	180	3,60	100	BMN1436
3.6	200	52.5	180	4,85	100	BMN2036
3.6	300	106	180	6,85	100	BMN2936
3.6	370	105	180	10,50	100	BMN3736
4.6	120	24	220	4,60	100	BMN1248
4.6	160	36	220	5,05	100	BMN1648
4.8	188	46	220	6,25	100	BMN1948
4.8	200	50	220	6,00	100	BMN2048
4.8	250	65	220	8,65	100	BMN2548
4.8	300	81	220	9,00	100	BMN3048
4.8	370	103.5	220	11,20	100	BMN3748
4.8	390	110	220	14,50	100	BMN3948
4.8	430	122.5	220	18,80	100	BMN4348
4.8	530	160	220	31,50	100	BMN5348
7.6	150	24	550	16,10	100	BMN1576
7.6	200	51	550	16,10	100	BMN2076
7.6	300	83	550	18,60	100	BMN2976
7.6	370	103.5	550	22,00	100	BMN3776
7.6	450	130.5	550	37,50	100	BMN4576
7.6	540	159	550	47,50	100	BMN5476
7.6	750	226	550	78,50	100	BMN7576
8.8	550	163.5	800	47,00	100	BMN5390
8.8	710	195	800	64,50	100	BMN7190
8.8	780	235.5	800	71,00	100	BMN7890
9.0	430	130.5	800	38,50	100	BMN4390
9.0	810	245	800	86,00	100	BMN8190
9.0	1020	295	800	119,50	100	BMN1090
9.0	1220	375.5	800	150,00	100	BMN1290
9.0	1530	460	800	204,50	100	BMN1590

- Geef a.u.b het aantal van de bindstrips en niet het aantal verpakking aan in uw bestelling

- Afgebeelde prijzen zijn per 100 stuks

1748-UL

Nylon bindstrips, voor zware toepassingen, zwart
UV en SCHOK bestendig

Materiaal: polyamide PA 6.6 + carbon black
Ontvlambaarheids klasse: UL 94-V2
Werk temperatuur: -40 °C + +85 °C
Minimum installatie temperatuur: -10 °C
Bestendig tegen chemicalien: Goed bestendig tegen basisolie, vetten, chloorhoudende oplosmiddelen. Beperkt bestand tegen zuren. Niet bestand tegen fenol.
Referentie standaards: EN 62275:2015-02
Klassificatie: type 1 (EN); type 21 (UL)

CE



A	L	Ø MAX	F MAX	€		
mm	mm	mm	N			
12.4	230	57	1200	46,00	100	BMN2412
12.4	480	136.5	1200	80,00	100	BMN4912
12.4	730	216.1	1200	110,00	100	BMN7412
12.4	880	263.9	1200	133,50	100	BMN8912
12.4	1000	305	1200	157,00	100	BMN1012

- Geef a.u.b het aantal van de bindstrips en niet het aantal verpakking aan in uw bestelling
- Afgebeelde prijzen zijn per 100 stuks

1748-N2D

Nylon bindstrips, zwart
UV bestendig

Materiaal: polyamide PA 6.6 + carbon black
Ontvlambaarheids klasse: UL 94-V2
Werk temperatuur: -40 °C + +85 °C
Minimum installatie temperatuur: -10 °C
Bestendig tegen chemicalien: Goed bestendig tegen basisolie, vetten, chloorhoudende oplosmiddelen. Beperkt bestand tegen zuren. Niet bestand tegen fenol.
Referentie standaards: EN 62275:2015-02
Klassificatie: type 1 (EN)

CE



A	L	Ø MAX	F MAX	€		
mm	mm	mm	N			
9.0	180	40	400	24,40	100	BMN1890
9.0	265	62	540	38,50	100	BMN2690
9.0	360	93	540	45,00	100	BMN3690

- Geef a.u.b het aantal van de bindstrips en niet het aantal verpakking aan in uw bestelling
- Afgebeelde prijzen zijn per 100 stuks

1748-BVO

Zelfdovende nylon bindstrips, wit

Materiaal: polyamide PA 6.6
Ontvlambaarheids klasse: UL 94-V0
Werk temperatuur: -40 °C + +85 °C
Minimum installatie temperatuur: -10 °C
Bestendig tegen chemicalien: Goed bestendig tegen basisolie, vetten, chloorhoudende reinigingsmiddelen. Beperkt bestendig tegen zuren. Niet bestand tegen fenol
Referentie standaard: EN 62275:2015-02
Klassificatie: type 1 (EN);

CE V0

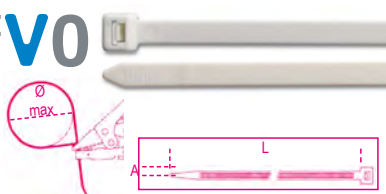

A	L	Ø MAX	F MAX	€		
mm	mm	mm	N			
2.5	100	20.5	80	2,03	100	BMB1025V0
3.6	150	36.0	180	4,85	100	BMB1536V0
3.6	200	52.5	180	7,05	100	BMB2036V0
4.8	200	49.5	230	7,95	100	BMB2048V0
4.8	300	81.0	230	12,00	100	BMB3048V0
4.8	370	106.7	230	16,60	100	BMB3848V0
7.6	370	106.7	540	29,00	100	BMB3876V0

- Geef a.u.b het aantal van de bindstrips en niet het aantal verpakking aan in uw bestelling
- Afgebeelde prijzen zijn per 100 stuks

1748-BX

Nylon bindstrips, blauw,
detecteerbaar door metaal detector

Materiaal: polyamide PA 6.6 + metaal deeltjes
Ontvlambaarheids klasse: UL 94-V0
Werk temperatuur: -40 °C + +85 °C
Minimum installatie temperatuur: -10 °C
Bestendig tegen chemicalien: Goed bestendig tegen basisolie, vetten, chloorhoudende reinigingsmiddelen. Beperkt bestendig tegen zuren. Niet bestand tegen fenol
Referentie standaard: EN 62275:2015-02
Klassificatie: type 1 (EN);

CE

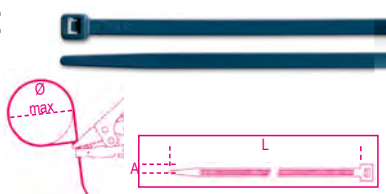

A	L	Ø MAX	F MAX	€		
mm	mm	mm	N			
2.5	100	20.5	80	2,47	100	BMBX1025
3.6	150	36.0	180	6,30	100	BMBX1536
3.6	200	52.5	180	8,75	100	BMBX2036
4.8	200	49.5	230	10,80	100	BMBX2048
4.8	300	81.0	230	16,30	100	BMBX3048
4.8	370	106.7	230	21,80	100	BMBX3848
7.6	370	106.7	540	39,00	100	BMBX3876

- Geef a.u.b het aantal van de bindstrips en niet het aantal verpakking aan in uw bestelling
- Afgebeelde prijzen zijn per 100 stuks

1748-BL

Nylon bindstrips, met stalen vertanding, naturel kleur

Materiaal: polyamide PA 6.6 + staal
Ontvlambaarheids klasse: UL 94-V2
Werk temperatuur: -40 °C + +85 °C
Minimum installatie temperatuur: -10 °C
Bestendig tegen chemicalien: Goed bestendig tegen basisolie, vetten, chloorhoudende reinigingsmiddelen. Beperkt bestendig tegen zuren. Niet bestand tegen fenol
Referentie standaard: EN 62275:2015-02
Klassificatie: type 1 (EN);

CE

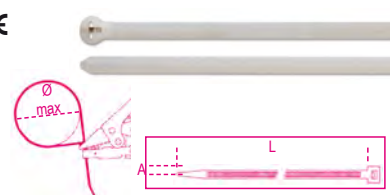

A	L	Ø MAX	F MAX	€		
mm	mm	mm	N			
2.5	100	20.5	180	4,85	100	BMBL1025
2.5	200	52.5	180	6,20	100	BMBL2025
3.6	140	33.0	250	10,80	100	BMBL1436
4.8	200	49.5	360	15,50	100	BMBL2048
4.8	300	81.0	360	20,30	100	BMBL3048
4.8	370	103.5	360	24,40	100	BMBL3748
7.6	370	103.5	780	44,00	100	BMBL3776

- Geef a.u.b het aantal van de bindstrips en niet het aantal verpakking aan in uw bestelling
- Afgebeelde prijzen zijn per 100 stuks

1748-NL

Nylon bindstrips, met stalen vertanding, zwart, UV bestendig

Materiaal: polyamide PA 6.6 + staal + carbon
Ontvlambaarheids klasse: UL 94-V2
Werk temperatuur: -40 °C + +85 °C
Minimum installatie temperatuur: -10 °C
Bestendig tegen chemicalien: Goed bestendig tegen basisolie, vetten, chloorhoudende reinigingsmiddelen. Beperkt bestendig tegen zuren. Niet bestand tegen fenol
Referentie standaard: EN 62275:2015-02
Klassificatie: type 1 (EN);

CE

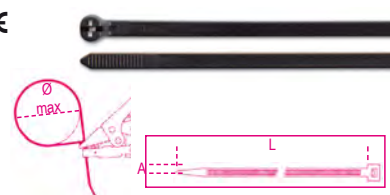

A	L	Ø MAX	F MAX	€		
mm	mm	mm	N			
2.5	100	20.5	180	4,85	100	BMNL1025
2.5	200	52.5	180	6,20	100	BMNL2025
3.6	140	33.0	250	10,80	100	BMNL1436
4.8	200	49.5	360	14,90	100	BMNL2048
4.8	300	81.0	360	19,30	100	BMNL3048
4.8	370	103.5	360	22,80	100	BMNL3748
7.6	370	103.5	780	43,00	100	BMNL3776

- Geef a.u.b het aantal van de bindstrips en niet het aantal verpakking aan in uw bestelling
- Afgebeelde prijzen zijn per 100 stuks

Beta

Beta

1748-BR

Hersluitbare nylon bindstrips,
naturel kleur

Materiaal: polyamide PA 6.6
Ontvlambaarheids klasse: UL 94-V2
Werk temperatuur: -40 °C ÷ +85 °C
Minimum installatie temperatuur: -10 °C
Bestendig tegen chemicaliën: Goed bestendig tegen basisolie, vetten, chloorhoudende reinigingsmiddelen.
Beperkt bestendig tegen zuren. Niet bestand tegen fenol
Referentie standaard: EN 62275:2015-02
Klassificatie: type 1 (EN); type 21 (UL)

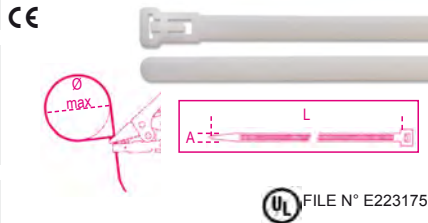

A	L	Ø MAX	F MAX	€	100	100
mm	mm	mm	N			
7.6	150	40	230	16,40	100	BMBR1576
7.6	200	55	230	17,60	100	BMBR2076
7.6	300	82	230	29,50	100	BMBR3076

- Geef a.u.b het aantal van de bindstrips en niet het aantal verpakking aan in uw bestelling
- Afgebeelde prijzen zijn per 100 stuks

1748-BH

Nylon bindstrips met bevestigingsoog,
naturel kleur

Materiaal: polyamide PA 6.6
Ontvlambaarheids klasse: UL 94-V2
Werk temperatuur: -40 °C ÷ +85 °C
Minimum installatie temperatuur: -10 °C
Bestendig tegen chemicaliën: Goed bestendig tegen basisolie, vetten, chloorhoudende reinigingsmiddelen.
Beperkt bestendig tegen zuren. Niet bestand tegen fenol
Referentie standaard: EN 62275:2015-02
Klassificatie: type 1 (EN); type 21 (UL)

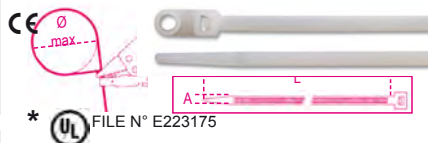

A	L	Ø MAX	F MAX	€	100	100
mm	mm	mm	N			
2.5	110	19.0	80	4,45	100	BMBH1125
* 4.8	200	49.8	230	10,80	100	BMBH2048
* 7.6	305	78.7	550	35,50	100	BMBH3076

- Geef a.u.b het aantal van de bindstrips en niet het aantal verpakking aan in uw bestelling
- Afgebeelde prijzen zijn per 100 stuks

1748-BP

Paneelmontage nylon bindstrips,
naturel kleur

Materiaal: polyamide PA 6.6
Ontvlambaarheids klasse: UL 94-V2
Werk temperatuur: -40 °C ÷ +85 °C
Minimum installatie temperatuur: -10 °C
Bestendig tegen chemicaliën: Goed bestendig tegen basisolie, vetten, chloorhoudende reinigingsmiddelen.
Beperkt bestendig tegen zuren. Niet bestand tegen fenol
Referentie standaard: EN 62275:2015-02
Klassificatie: type 1 (EN); type 21 (UL)



A	L	Ø MAX	F MAX	€	100	100
mm	mm	mm	N			
3.6	155	37.9	180	6,70	100	BMBP1536
* 4.8	200	50.8	230	11,50	100	BMBP2048

- Geef a.u.b het aantal van de bindstrips en niet het aantal verpakking aan in uw bestelling
- Afgebeelde prijzen zijn per 100 stuks

1748-BT

Nylon bindstrips met horizontaal markeer label, 25x8mm,
naturel kleur

Materiaal: polyamide PA 6.6
Ontvlambaarheids klasse: UL 94-V2
Werk temperatuur: -40 °C ÷ +85 °C
Minimum installatie temperatuur: -10 °C
Bestendig tegen chemicaliën: Goed bestendig tegen basisolie, vetten, chloorhoudende reinigingsmiddelen.
Beperkt bestendig tegen zuren. Niet bestand tegen fenol
Referentie standaard: EN 62275:2015-02
Klassificatie: type 1 (EN); type 21 (UL)

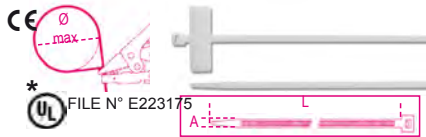

A	L	Ø MAX	F MAX	€	100	100
mm	mm	mm	N			
2.5	100	22.0	80	7,35	100	BMBT1025
2.5	200	53.5	80	11,70	100	BMBT2025

- Geef a.u.b het aantal van de bindstrips en niet het aantal verpakking aan in uw bestelling
- Afgebeelde prijzen zijn per 100 stuks

1748-BT2

Nylon bindstrips met verticaal markeer label, 13x27mm,
naturel kleur

Materiaal: polyamide PA 6.6
Ontvlambaarheids klasse: UL 94-V2
Werk temperatuur: -40 °C ÷ +85 °C
Minimum installatie temperatuur: -10 °C
Bestendig tegen chemicaliën: Goed bestendig tegen basisolie, vetten, chloorhoudende reinigingsmiddelen.
Beperkt bestendig tegen zuren. Niet bestand tegen fenol
Referentie standaard: EN 62275:2015-02
Klassificatie: type 1 (EN)



A	L	Ø MAX	F MAX	€	100	100
mm	mm	mm	N			
4.8	190	51	230	13,80	100	BMBT12248

- Geef a.u.b het aantal van de bindstrips en niet het aantal verpakking aan in uw bestelling
- Afgebeelde prijzen zijn per 100 stuks

1748-BT3

Nylon bindstrips met los markeerlabel, 20x9mm,
naturel kleur

Materiaal: polyamide PA 6.6
Ontvlambaarheids klasse: UL 94-V2
Werk temperatuur: -40 °C ÷ +85 °C
Minimum installatie temperatuur: -10 °C
Bestendig tegen chemicaliën: Goed bestendig tegen basisolie, vetten, chloorhoudende reinigingsmiddelen.
Beperkt bestendig tegen zuren. Niet bestand tegen fenol
Referentie standaard: EN 62275:2015-02
Klassificatie: type 1 (EN)

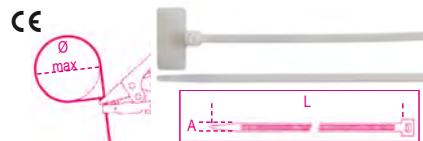

A	L	Ø MAX	F MAX	€	100	100
mm	mm	mm	N			
2.5	110	22	80	7,70	100	BMBT1125

- Geef a.u.b het aantal van de bindstrips en niet het aantal verpakking aan in uw bestelling
- Afgebeelde prijzen zijn per 100 stuks

1748-BA1

Bevestigingsvoet

Materiaal: polyamide PA 6.6
Ontvlambaarheids klasse: UL 94-V2
Werk temperatuur: -40 °C ÷ +85 °C
Minimum installatie temperatuur: -10 °C
Bestendig tegen chemicaliën: Goed bestendig tegen basisolie, vetten, chloorhoudende reinigingsmiddelen.
Beperkt bestendig tegen zuren. Niet bestand tegen fenol



SxDxH	Ø	F	€	100	100
mm	mm	mm			
15.2x9.4x6.8	3.3	3.6	10,40	100	BMB0905
22x16.2x10.8	5.2	9	23,40	100	BMB0906

- Geef a.u.b het aantal van de bindstrips en niet het aantal verpakking aan in uw bestelling
- Afgebeelde prijzen zijn per 100 stuks

1748-NA1

Bevestigingsvoet

Materiaal: polyamide PA 6.6
Ontvlambaarheids klasse: UL 94-V2
Werk temperatuur: -40 °C ÷ +85 °C
Minimum installatie temperatuur: -10 °C
Bestendig tegen chemicaliën: Goed bestendig tegen basisolie, vetten, chloorhoudende reinigingsmiddelen.
Beperkt bestendig tegen zuren. Niet bestand tegen fenol



SxDxH	Ø	F	€	100	100
mm	mm	mm			
15.2x9.4x6.8	3.3	3.6	10,80	100	BMN0905
22x16.2x10.8	5.2	9	18,90	100	BMN0906

- Geef a.u.b het aantal van de bindstrips en niet het aantal verpakking aan in uw bestelling
- Afgebeelde prijzen zijn per 100 stuks



1748-BA2

Bevestigingsvoet tweeweg

Materiaal: polyamide PA 6.6
 Ontvlambaarheids klasse: UL 94-V2
 Werk temperatuur: -40 °C + +85 °C
 Minimum installatie temperatuur: -10 °C
 Bestendig tegen chemicalien: Goed bestendig tegen basisolie, vetten, chloorhoudende reinigingsmiddelen.
 Beperkt bestendig tegen zuren. Niet bestand tegen fenol

CE

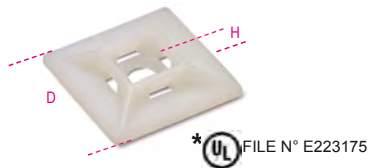

SxDxH mm	F mm	€	100	100
19x19x5.4	3.6	12,90	100	BMB0901
* 28x28x7	4.8	17,80	100	BMB0902
* 28x28x5.8	4.8	16,30	100	BMB0903

1748-NA2

Bevestigingsvoet, tweeweg,
 UV bestendig

Materiaal: polyamide PA 6.6
 Ontvlambaarheids klasse: UL 94-V2
 Werk temperatuur: -40 °C + +85 °C
 Minimum installatie temperatuur: -10 °C
 Bestendig tegen chemicalien: Goed bestendig tegen basisolie, vetten, chloorhoudende reinigingsmiddelen.
 Beperkt bestendig tegen zuren. Niet bestand tegen fenol

CE



SxDxH mm	F mm	€	100	100
19x19x5.4	3.6	12,90	100	BMN0901
* 28x28x7	4.8	17,80	100	BMN0902
* 28x28x5.8	4.8	16,20	100	BMN0903

- Geef a.u.b het aantal van de bindstrips en niet het aantal verpakking aan in uw bestelling
 - Afgebeelde prijzen zijn per 100 stuks



1748-S

Zelfborgende roestvaststalen kabelbinders

Materiaal: Roestvast staal AISI 304
 Borg systeem: kogelafsluiting
 Ontvlambaarheidsklasse: niet brandbaar
 Plenum waarde: AH-1
 UV bestendigheid: zeer goed
 Werk temperatuur: -60 °C + +300 °C
 Minimum installatie temperatuur: -60 °C
 Bestendig tegen chemicalien: zeer goed
 Referentie norm: EN 62275:2015-02
 Klassificatie: type 2 (EN); type 2 (UL)

CE

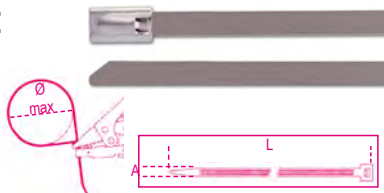

A mm	L mm	ØMAX mm	Trazione N	€	100	100
4.6	125	38	890	78,50	100	BMS1345
4.6	200	61.9	890	81,00	100	BMS2045
7.9	200	61.9	1500	86,50	100	BMS2079
4.6	290	90.6	890	86,50	100	BMS3045
7.9	300	90.6	1500	99,00	100	BMS3079
4.6	360	112.8	890	95,50	100	BMS3745
7.9	360	112.8	1500	108,50	100	BMS3779
7.9	500	163.8	1500	128,50	100	BMS5079
4.6	520	163.8	890	95,50	100	BMS5245
4.6	680	214.8	890	101,50	100	BMS6845
7.9	680	214.8	1500	147,00	100	BMS6879
4.6	840	265.7	890	106,00	100	BMS8445
7.9	840	265.7	1500	173,00	100	BMS8479

1748-SC

Zelfborgende roestvast stalen kabelbinders,
 zwarte polyester coating

Materiaal: Roestvast staal AISI 304 + polyester
 Borg systeem: kogelafsluiting
 Ontvlambaarheidsklasse: niet brandbaar
 Plenum waarde: AH-1
 UV bestendigheid: zeer goed
 Werk temperatuur: -60 °C + +300 °C
 Minimum installatie temperatuur: -60 °C
 Bestendig tegen chemicalien: zeer goed
 Referentie norm: EN 62275:2015-02
 Klassificatie: type 2 (EN); type 2 (UL)

CE

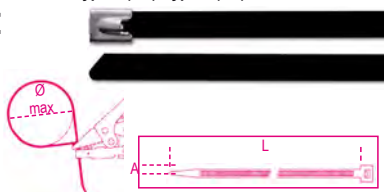

A mm	L mm	ØMAX mm	Trazione N	€	100	100
4.6	125	38	450	81,00	100	BMSC1345
4.6	200	61.9	450	95,50	100	BMSC2045
7.9	200	61.9	800	96,00	100	BMSC2079
4.6	290	90.6	450	106,50	100	BMSC3045
7.9	300	90.6	800	113,00	100	BMSC3079
4.6	360	112.8	450	117,00	100	BMSC3745
7.9	360	112.8	800	127,50	100	BMSC3779
7.9	520	163.8	800	160,00	100	BMSC5079
4.6	520	163.8	450	119,00	100	BMSC5245
4.6	680	214.8	450	134,50	100	BMSC6845
7.9	680	214.8	800	182,00	100	BMSC6879
4.6	840	265.7	450	143,50	100	BMSC8445
7.9	840	265.7	800	218,00	100	BMSC8479

1748-BV

Klittenband kabelbinders, wikkelband,
 wit

Materiaal: polyethyleen-polyamide (PE-PA)
 Bedrijfstemperatuur: -20 °C + +60 °C



A mm	L mm	Ø MAX mm	F MAX N	€	100	100
12,7	229	55	180	236,50	10	BMBV2312
19	229	55	220	271,00	10	BMBV2319

- Vermeld bij uw bestelling het aantal kabelbinders en niet het aantal verpakkingen
 - Genoemde prijzen zijn per 100 stuks

1748-NV

Klittenband kabelbinders, wikkelband,
 zwart

Materiaal: polyethyleen-polyamide (PE-PA)
 Bedrijfstemperatuur: -20 °C + +60 °C



A mm	L mm	Ø MAX mm	F MAX N	€	100	100
12,7	229	55	180	236,50	10	BMNV2312

- Vermeld bij uw bestelling het aantal kabelbinders en niet het aantal verpakkingen
 - Genoemde prijzen zijn per 100 stuks

1743

Bindstriptang voor Nylon bindstrips

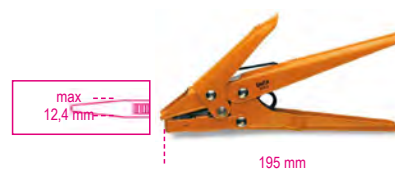

1743	€	100	100
	57,50	1	017430001

1743T

Kniptang voor nylon bindstrips

• Eveneens geschikt voor het knippen van dunne kabels (3x1.5mm²; 1x17mm²)



1743T	€	100	100
	38,00	1	017430100



1748-N

montagegereedschap voor nylon kabelbinders, 2,5 tot 4,8 mm breed

Snijdt automatisch wanneer de ingestelde spanning is bereikt. Met aanspanstelsysteem voor het aanpassen van de spanning.

Materialen: glazen frame van polymeer en glasvezel, interieurdelen van metaal

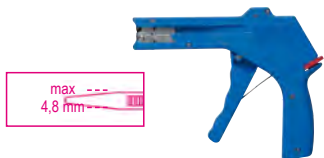

BM1100 € 65,50 1 BM1100

1748-ST

Automatische klem voor roestvast stalen bindstrips, voor bindstrips varierende in breedte van 4.6 tot 9 mm, automatische spanning en snij controle



BM1105 € 251,00 1 BM1105

1638M

dunwandige krimpkouzen, in minibox

Krimpverhouding: 2:1
Materiaal: polyethyleen
Bedrijfstemperatuur: -55 °C ÷ +125 °C
Krimptemperatuur: +70 °C ÷ +125 °C
Maximale VRMS: 600 V
Zelfdovend omhulsel: VW-1 (UL 224)
Halogeenvrij



mm	L m	Ø1 mm	Ø2 mm	€	U	BM
1,6	12	1,6	0,8	20,10	1	BMGBS016MNE
2,4	11	2,4	1,2	20,10	1	BMGBS024MNE
3,2	11	3,2	1,6	20,10	1	BMGBS032MNE
4,8	10	4,8	2,4	20,10	1	BMGBS048MNE
6,4	9	6,4	3,2	20,10	1	BMGBS064MNE
9,5	7	9,5	4,8	20,10	1	BMGBS095MNE
12,7	6	12,7	6,4	20,10	1	BMGBS127MNE
19	5	19,1	9,5	20,50	1	BMGBS190MNE
25,4	3,5	25,4	12,7	20,90	1	BMGBS254MNE

1639ESB

PVC isolatietape

Werktemperatuur: 0-90°C
Treksterkte: 28N/cm gelijk aan 18.6 N/mm²
Verlenging: 200%
Hechting op staal: 2.2N/cm
Hechting op rugzijde: 2 N/cm
Diëlectrisch sterkte: 45kV/mm
Ontvlambaarheid: vlamvertragend
Referentie standaard: IEC 60454-2
Klassificatie: CEI EN 60454-3-1-5/F-PVCP/90



S mm	A mm	L m	€	U	BM
0.15	15	10	0,97	10	BMESB1510BI
0.15	15	10	0,97	10	BMESB1510BL
0.15	15	10	0,97	10	BMESB1510GI
0.15	15	10	0,97	10	BMESB1510GR
0.15	15	10	1,13	10	BMESB1510GV
0.15	15	10	0,97	10	BMESB1510MA
0.15	15	10	0,97	10	BMESB1510NE
0.15	15	10	0,97	10	BMESB1510RO
0.15	15	10	0,97	10	BMESB1510VE
0.15	15	25	2,29	10	BMESB1525BI
0.15	15	25	2,29	10	BMESB1525BL
0.15	15	25	2,29	10	BMESB1525GI
0.15	15	25	2,29	10	BMESB1525GR
0.15	15	25	2,37	10	BMESB1525GV
0.15	15	25	2,29	10	BMESB1525MA
0.15	15	25	2,29	10	BMESB1525NE
0.15	15	25	2,29	10	BMESB1525RO
0.15	15	25	2,29	10	BMESB1525VE
0.15	19	25	2,55	10	BMESB1925BI
0.15	19	25	2,55	10	BMESB1925BL
0.15	19	25	2,55	10	BMESB1925GI
0.15	19	25	2,55	10	BMESB1925GR
0.15	19	25	2,64	10	BMESB1925GV
0.15	19	25	2,55	10	BMESB1925MA
0.15	19	25	2,55	10	BMESB1925NE
0.15	19	25	2,55	10	BMESB1925RO
0.15	19	25	2,55	10	BMESB1925VE
0.15	25	25	3,50	8	BMESB2525BI
0.15	25	25	3,50	8	BMESB2525BL
0.15	25	25	3,50	8	BMESB2525GI
0.15	25	25	3,50	8	BMESB2525GR
0.15	25	25	3,65	8	BMESB2525GV
0.15	25	25	3,50	8	BMESB2525MA
0.15	25	25	3,50	8	BMESB2525NE
0.15	25	25	3,50	8	BMESB2525RO
0.15	25	25	3,50	8	BMESB2525VE
0.15	50	25	5,65	4	BMESB5025NE

1639ESC

PVC isolatietape

Werktemperatuur: 0-80°C
Treksterkte: 28N/cm gelijk aan 18.6 N/mm²
Verlenging: 200%
Hechting op staal: 2.2N/cm
Hechting op rugzijde: 2.2 N/cm
Diëlectrisch sterkte: 38kV/mm
Ontvlambaarheid: vlamvertragend
Referentie standaard: ASTM-D-1000; UL510
Klassificatie: CEI EN 60454-3-1-5/F-PVCP/90



S mm	A mm	L m	€	U	BM
0.18	19	20	3,35	10	BMESC1920NE

1639ETA

PVC isolatietape voor extreme temperaturen

Werktemperatuur: -18 ÷ +105 °C
Treksterkte: 35N/cm gelijk aan 19.4 N/mm²
Verlenging: 300%
Hechting op staal: 3.1N/cm
Hechting op rugzijde: 2.7 N/cm
Diëlectrisch sterkte: 55.5kV/mm
Ontvlambaarheid: vlamvertragend
Referentie standaard: ASTM-D-1000; UL510
Klassificatie: CEI EN 60454-3-1-5/F-PVCP/90



S mm	A mm	L m	€	U	BM
0.18	19	20	9,55	1	BMETA1920NE

1639EAB

EPR zelf-fuserende elektrische tape

Werktemperatuur: -40 ÷ +90 °C
Treksterkte: 2.4 N/mm²
Verlenging: 300%
Diëlectrisch sterkte: 29.5kV/mm
Ontvlambaarheid: vlamvertragend
Referentie standaard: ASTM-D-4388; ASTM-D-4325
Buitengewoon bestendig tegen: Vocht, corrosie, chemicalien



S mm	A mm	L m	€	U	BM
0.76	19	9	20,30	1	BMEAB1909NE



Beta

Beta

Quality Tools



HET BETA ASSORTIMENT IN **BLISTERVERPAKKING**

Voor het
vereenvoudigen
van verkoop

- **Verhoogde herkenbaarheid**
- **Efficiënter wandgebruik**
- **Bar code**



Blisterverpakking:

- *scheurvrij PVC*
- *4 afmetingen voor optimaal gebruik van de wand*
- *Nieuwe generatie van fixeren met elastische lus.*

42K



mm	€	🔧	📦
5,5x5,5	8,35	5	000429505
6x6	8,45	5	000429506
7x7	8,60	5	000429507
8x8	8,75	5	000429508
9x9	9,25	5	000429509
10x10	9,45	5	000429510
11x11	10,20	5	000429511
12x12	10,30	5	000429512
13x13	10,40	5	000429513
14x14	11,70	5	000429514
15x15	12,90	5	000429515
16x16	13,30	5	000429516
17x17	14,00	5	000429517
18x18	15,00	5	000429518
19x19	15,30	5	000429519
20x20	17,20	3	000429520
21x21	18,60	3	000429521
22x22	19,20	3	000429522
23x23	20,50	3	000429523
24x24	21,40	3	000429524
25x25	22,80	2	000429525
26x26	24,40	2	000429526
27x27	26,50	2	000429527
28x28	27,00	2	000429528
29x29	30,00	2	000429529
30x30	31,00	2	000429530
32x32	34,50	2	000429532

55K



mm	€	🔧	📦
6x7	5,55	5	000559012
8x9	5,80	5	000559021
10x11	6,20	5	000559030
10x12	8,15	5	000559033
10x13	8,90	5	000559035
12x13	6,95	5	000559042
12x14	9,15	5	000559045
13x17	10,80	5	000559051
14x15	8,65	5	000559054
14x17	11,70	5	000559057
16x17	10,10	5	000559060
17x19	12,90	2	000559063
18x19	11,80	2	000559066
19x22	14,70	2	000559069
20x22	13,60	2	000559075
21x23	14,80	2	000559078
22x24	16,00	2	000559081
24x26	16,60	2	000559087
24x27	18,30	2	000559090
25x28	18,80	2	000559096
27x29	20,80	2	000559099
27x30	23,70	2	000559102
30x32	23,70	2	000559108

90K



mm	€	🔧	📦
6x7	11,00	5	000909006
8x9	12,10	5	000909012
10x11	13,40	5	000909018
12x13	14,60	5	000909027
14x15	16,20	5	000909033
16x17	18,40	5	000909039
18x19	21,30	5	000909045

mm	€	🔧	📦
20x22	24,90	3	000909051
21x23	27,50	2	000909057
24x26	31,50	2	000909063
24x27	35,00	2	000909067
25x28	38,50	2	000909070
27x29	41,00	2	000909073
30x32	46,00	2	000909080

93K



mm	€	🔧	📦
21x22	51,50	3	000939021

94K



mm	€	🔧	📦
8x10	19,90	2	000949008
9x11	20,80	2	000949009
10x11	21,50	2	000949010
11x13	22,30	2	000949011
12x14	23,20	2	000949012
13x15	23,20	2	000949013
14x15	27,50	2	000949014
14x17	28,00	2	000949015
17x19	28,50	2	000949017
19x22	31,50	2	000949019
22x24	38,00	2	000949022
24x27	41,00	2	000949024
30x32	52,50	2	000949030

96/SC9



96/SC9	€	🔧	📦
1,5-2-2,5-3-4-5-6-8-10 mm	23,50	1	000960374

96/ST6K



96/ST6K	€	🔧	📦
2,5-3-4-5-6-8 mm	16,60	3	000969370

96N/ST6K



96N/ST6K	€	🔧	📦
2,5-3-4-5-6-8 mm	11,80	3	000969640

96BPA/SC9



96BPA/SC9	€	🔧	📦
1,5-2-2,5-3-4-5-6-8-10 mm	54,00	1	000961974

96BP-CL/SC9



96BP-CL/SC9	€	🔧	📦
1,5-2-2,5-3-4-5-6-8-10 mm	57,00	1	000961619

96BPC/SC9



96BPC/SC9	€	🔧	📦
1,5-2-2,5-3-4-5-6-8-10 mm	49,00	1	000960354

96C/AS



	€	🔧	📦
1/16	1,95	20	000961702
3/32	2,73	20	000961706
1/8	2,86	20	000961710
5/32	3,40	20	000961714
3/16	3,75	20	000961716
7/32	4,25	20	000961718
1/4	4,80	20	000961720
5/16	5,40	10	000961724
3/8	6,55	10	000961728

96LBP/SC9



96LBP/SC9 € 55,50 1 000961354
1,5-2-2,5-3-4-5-6-8-10 mm

96/BGS7



96/BGS7 € 33,00 1 000960367
1,5-2-2,5-3-4-5-6 mm

96/BG7



96/BG7 € 35,00 1 000960368
2,5-3-4-5-6-8-10 mm

96TK



mm	€	Hand	Code
2	12,50	5	000969934
2,5	12,50	5	000969935
3	13,10	5	000969936
4	13,40	5	000969938
5	13,90	5	000969940
6	15,70	5	000969941
8	19,90	3	000969943
10	23,20	3	000969945

97BTX/SC8



97BTX/SC8 € 92,50 1 000970164
T9-T10-T15-T20-T25-T27-T30-T40

97BTXL/SC8



97BTXL/SC8 € 106,00 1 000970364
T9-T10-T15-T20-T25-T27-T30-T40

111E



L mm	€	Hand	Code
100	27,00	3	001110110
150	29,00	3	001110115
200	35,00	3	001110120
250	42,00	3	001110125
300	56,00	3	001110130
380	109,50	3	001110138
450	182,50	2	001110145
600	252,00	1	001110160

111EN



L mm	€	Hand	Code
100	25,00	3	001110410
150	27,00	3	001110415
200	31,00	3	001110420
250	38,00	3	001110425
300	51,00	3	001110430
380	101,00	3	001110438
450	172,00	2	001110445

111ER



L mm	€	Hand	Code
200	36,50	3	001110520
250	45,00	3	001110525
300	58,50	2	001110530



123/K4



123/K4 € 36,50 1 001230504

142K



mm	€	Hand	Code
6	20,80	3	001429006
7	20,80	3	001429007
8	21,10	3	001429008
9	22,40	3	001429009
10	23,10	3	001429010
11	23,80	3	001429011
12	24,70	3	001429012
13	26,50	3	001429013
14	27,50	2	001429014
15	29,00	2	001429015
16	30,50	2	001429016
17	32,50	2	001429017
18	34,50	2	001429018
19	35,50	2	001429019
21	46,00	1	001429021
22	48,00	1	001429022
24	55,50	1	001429024

192/S2

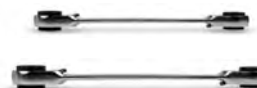

192/S2 € 75,50 1 001920070
8x10/12x13 mm
16x17/18x19 mm

195K



mm	€	Hand	Code
8x10	23,40	2	001959010
12x13	27,00	2	001959013
14x15	28,00	2	001959015
16x18	34,00	2	001959018
17x19	35,00	2	001959019

374K



374K € 44,00 1 003749024

850MQ



L mm	€		
233	24,30	1	008500910

855P



L1 mm	€		
240	85,00	1	008550010

860/58K



L mm	€		
126	88,50	1	008609884

860LP



SxA mm	€		
0,5x3	2,23	5	008600005
0,6x4,5	2,23	5	008600010
0,8x5,5	2,23	5	008600015
1x5,5	2,23	5	008600020
1,2x6,5	2,23	5	008600025

860PH



PH	€		
0	2,23	5	008600220
1	2,23	5	008600225
2	2,23	5	008600230
3	2,23	5	008600245
4	3,30	5	008600250

860PZ



PZ	€		
1	2,23	5	008600320
2	2,23	5	008600325
3	2,23	5	008600330
4	3,30	5	008600335

860PE



mm	€		
2	2,35	5	008600101
2,5	2,35	5	008600102
3	2,35	5	008600103
4	2,35	5	008600104
5	2,35	5	008600105
6	2,35	5	008600106
8	3,05	5	008600108
10	3,05	5	008600110

860TX



mm	€		
T6	3,05	5	008600704
T7	3,05	5	008600705
T8	3,05	5	008600710
T9	3,05	5	008600715
T10	2,40	5	008600720
T15	2,40	5	008600725
T20	2,40	5	008600730
T25	2,40	5	008600735
T27	2,40	5	008600740
T30	2,40	5	008600745
T40	2,40	5	008600750

860RTX



mm	€		
T9	3,30	5	008600550
T10	3,30	5	008600555
T15	3,30	5	008600560
T20	3,30	5	008600565
T25	3,30	5	008600570
T27	3,30	5	008600575
T30	3,30	5	008600580
T40	3,30	5	008600585

860/C27



860/C27	€		
	103,50	1	008600880

860MIX/A10



860MIX/A10	€		
	42,50	1	008600900

860TX/A10



860TX/A10	€		
	46,50	1	008600970

860MIX/A31



860MIX/A31	€		
	103,50	1	008600902

862F/A7



862F/A7	€		
	59,50	1	008620950

900K



mm	€		
4	4,90	10	009009040
4,5	4,90	10	009009045
5	4,90	10	009009050
5,5	4,90	10	009009055
6	4,90	10	009009060
7	4,90	10	009009070
8	4,90	10	009009080
9	4,90	10	009009090
10	4,90	10	009009100
11	4,90	10	009009110
12	4,90	10	009009120
13	4,95	10	009009130
14	5,20	10	009009140

900/20LK



L mm	€		
100	10,70	5	009009819

900/25K

14"



L mm	€	Hand	Code
41	20,50	5	009009830

900BG/30K

14"



L mm	€	Hand	Code
128	10,50	5	009009834

900/55K

14"



L mm	€	Hand	Code
125	53,50	5	009009870

900/55ZK

14"



L mm	€	Hand	Code
125	53,50	3	009009882

900/58K

14"



L mm	€	Hand	Code
126	80,50	2	009009884

910AK

3/8"



mm	€	Hand	Code
6	7,40	5	009109006
7	7,40	5	009109007
8	7,40	5	009109008
9	7,40	5	009109009
10	7,40	5	009109010
11	7,40	5	009109011
12	7,85	5	009109012
13	7,85	5	009109013
14	7,85	5	009109014
15	7,85	5	009109015
16	8,50	5	009109016
17	8,50	5	009109017
18	8,50	5	009109018
19	8,50	5	009109019
20	9,10	5	009109020
21	9,10	5	009109021
22	9,30	5	009109022

910/21K

3/8"



L mm	€	Hand	Code
125	13,70	5	009109822

910/25K

3/8"



L mm	€	Hand	Code
54,6	24,70	5	009109830

910/55K

3/8"



L mm	€	Hand	Code
200	57,50	3	009109882

910/58K

3/8"



L mm	€	Hand	Code
222	89,00	1	009109884

920AK

12"



mm	€	Hand	Code
10	7,40	10	009209010
11	7,40	10	009209011
12	7,40	10	009209012
13	7,85	10	009209013
14	7,85	10	009209014
15	7,85	10	009209015
16	8,45	10	009209016
17	8,45	10	009209017
18	8,45	10	009209018
19	8,45	10	009209019
20	9,40	5	009209020
21	9,40	5	009209021
22	9,40	5	009209022
23	10,50	5	009209023
24	10,50	5	009209024
25	10,50	5	009209025
26	10,70	5	009209026
27	10,70	5	009209027
28	10,70	5	009209028
29	11,10	5	009209029
30	11,10	5	009209030
32	11,70	5	009209032

920/21K

12"



L mm	€	Hand	Code
125	18,30	5	009209822

920/25K

12"



L mm	€	Hand	Code
75	30,00	5	009209830

920/55K

12"



L mm	€	Hand	Code
275	66,50	3	009209882

920/58K

12"



L mm	€	Hand	Code
281	104,00	1	009209926

935K



mm	€	Hand	Code
6x7	9,20	5	009359105
8x9	9,95	5	009359111
10x11	10,90	5	009359115
12x13	12,20	5	009359117
14x15	14,30	5	009359126
16x17	15,40	5	009359128
18x19	18,00	5	009359131
20x22	21,70	3	009359138

937K



mm	€	Hand	Code
6x6	9,80	5	009379006
7x7	10,20	5	009379007
8x8	10,60	5	009379008
9x9	10,90	5	009379009
10x10	11,20	5	009379010
11x11	12,00	5	009379011
12x12	13,20	5	009379012
13x13	13,40	5	009379013
14x14	14,80	5	009379014
15x15	16,60	5	009379015
16x16	17,80	5	009379016
17x17	18,10	5	009379017
18x18	18,80	5	009379018
19x19	19,40	5	009379019
20x20	21,60	5	009379020
21x21	24,70	3	009379021
22x22	25,50	3	009379022

943BKK



mm	€	5	009439005
5,5	20,40	5	009439005
6	20,40	5	009439006
7	21,60	5	009439007
8	21,60	5	009439008
10	22,80	3	009439010
13	24,00	3	009439013

951K

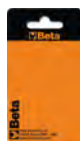

mm	€	5	009519521
2	21,00	5	009519521
2,5	21,00	5	009519525
3	21,00	5	009519530
3,5	21,60	5	009519535
4	21,60	5	009519540
4,5	23,50	5	009519545
5	23,50	5	009519550
6	26,50	5	009519560
8	29,00	5	009519580
10	37,50	5	009519610

1032K



L mm	€	5	010329013
140x0,9	27,00	5	010329013
140x1,3	26,00	5	010329014
180	28,50	5	010329017

1033K



L mm	€	5	010339013
140x0,9	31,00	5	010339013
140x1,3	31,00	5	010339014
180	32,00	5	010339017

1034K



L mm	€	5	010349013
130x0,9	31,00	5	010349013
130x1,3	31,00	5	010349014
170	32,00	5	010349017

1036K



L mm	€	5	010369013
140x0,9	29,00	5	010369013
140x1,3	29,00	5	010369014
175	30,00	5	010369017

1037K



L mm	€	5	010379013
140x0,9	33,00	5	010379013
140x1,3	32,50	5	010379014
175	34,50	5	010379017

1038K



L mm	€	5	010389013
135x0,9	33,00	5	010389013
135x1,3	32,50	5	010389014
175	34,50	5	010389017

1044NK



L mm	€	5	010449025
250	28,50	5	010449025

1048NK



L mm	€	3	010489910
175	36,00	3	010489910
250	38,50	5	010489915

1048VNK



L mm	€	3	010489111
175	31,00	3	010489111
250	36,00	5	010489116

1052K



L mm	€	3	010529014
140	29,00	3	010529014
190	35,00	3	010529019
240	38,00	3	010529024

1082K



L mm	€	5	010829004
140	31,50	5	010829004
160	33,00	5	010829006

1082GK



L mm	€	5	010829064
140	27,50	5	010829064
160	28,50	5	010829066

1082BMK



L mm	€	3	010829034
140	39,50	3	010829034
160	43,00	3	010829036

1082GBMK



L mm	€	3	010829264
140	34,50	3	010829264
160	39,00	3	010829266

1084K



L mm	€	3	010849006
160	37,00	3	010849006

1084GK



L mm	€		
160	31,00	5	010849066

1084BMK



L mm	€		
160	45,50	3	010849036

1084GBMK



L mm	€		
160	47,50	3	010849266

1088K



L mm	€		
160	45,50	2	010889006

1088BMK



L mm	€		
160	55,00	2	010889036

1096K



L mm	€		
200	27,00	5	010969020

1098K



L mm	€		
190	22,70	5	010989190
220	25,50	5	010989220

1098PLK



L mm	€		
220	27,00	5	010989320

1112K



L mm	€		
200	30,00	2	011129020

1122K



L mm	€		
250	43,50	2	011229020

1123K



L mm	€		
250	43,50	2	011239020

1124K



L mm	€		
250	43,50	2	011249020

1128BAX



L mm	€		
150	40,50	5	011280088

1128BMX



L mm	€		
147	21,30	5	011280051

1128BSX



L mm	€		
148	36,00	5	011280061

1128FX



L mm	€		
145	39,50	5	011280090

1128FXS



L mm	€		
145	45,50	5	011280095

1129BMK



L mm	€		
145	21,70	5	011299000

1130BMX



L mm	€	Icon	Code
185	23,10	1	011300002

1132K



L mm	€	Icon	Code
170	57,50	2	011329107

1132BMK



L mm	€	Icon	Code
170	71,00	2	011329137

1142BMK



L mm	€	Icon	Code
160	47,00	3	011429036

1144T



L mm	€	Icon	Code
112	24,90	1	011440060

1149F



L mm	€	Icon	Code
175	19,90	1	011490010

1150K



L mm	€	Icon	Code
160	26,00	5	011509046
180	28,00	5	011509048
200	31,00	5	011509050
220	34,00	2	011509052

1150GK



L mm	€	Icon	Code
160	25,00	5	011509066
180	27,00	5	011509068
200	29,00	5	011509070
220	31,50	2	011509072

1150BMK



L mm	€	Icon	Code
160	32,00	3	011509146
180	36,00	3	011509148
200	39,00	3	011509150
220	42,00	2	011509152

1150GBMK



L mm	€	Icon	Code
160	30,00	3	011509266
180	32,50	3	011509268
200	36,50	3	011509270
220	38,50	2	011509272

1162K



L mm	€	Icon	Code
160	31,00	5	011629006
200	36,50	5	011629010

1162GK



L mm	€	Icon	Code
160	25,00	5	011629066
200	28,50	5	011629070

1162BMK



L mm	€	Icon	Code
160	38,00	3	011629036
200	43,00	3	011629040

1162GBMK



L mm	€	Icon	Code
160	31,50	3	011629266
200	37,00	3	011629270

1164K



L mm	€	Icon	Code
160	33,00	5	011649006
200	38,00	5	011649010

1164BMK



L mm	€	Icon	Code
160	40,50	3	011649036
200	45,00	3	011649040

1166K



L mm	€	Icon	Code
160	31,00	5	011669006
200	36,50	5	011669010

1166GK



L mm	€	Hand	Units	Code
160	25,00	5	3	011669066
200	28,50	5	3	011669070

1166BMK



L mm	€	Hand	Units	Code
160	38,00	3	3	011669036
200	43,00	3	3	011669040

1166GBMK



L mm	€	Hand	Units	Code
160	31,50	3	3	011669266
200	37,00	3	3	011669270

1168K



L mm	€	Hand	Units	Code
160	33,00	5	3	011689006
200	38,00	5	3	011689010

1168GK



L mm	€	Hand	Units	Code
160	27,50	5	3	011689066
200	32,00	5	3	011689070

1168BMK



L mm	€	Hand	Units	Code
160	40,50	3	3	011689036
200	45,00	3	3	011689040

1168GBMK



L mm	€	Hand	Units	Code
160	35,50	3	3	011689266
200	39,50	3	3	011689270

1201E/K



SxAxL mm	€	Hand	Units	Code
0,4x2,5x50	4,65	5	5	012019203
0,4X2,5x75	4,85	5	5	012019206
0,5x3x75	4,90	5	5	012019209
0,5x3x100	5,35	5	5	012019212
0,6x3,5X75	5,50	5	5	012019218
0,6x3,5x100	5,50	5	5	012019221
0,8x4x100	5,65	5	5	012019230
0,8x4x125	5,70	5	5	012019233
0,8x4X150	6,25	5	5	012019236
1,0x5,5x100	6,85	5	5	012019239
1,0x5,5X125	7,05	5	5	012019240
1,0x5,5x150	7,20	5	5	012019242
1,2x6,5x100	7,95	5	5	012019248
1,2x6,5x125	8,20	5	5	012019250
1,2x6,5x150	8,55	5	5	012019251
1,2x8x150	10,90	3	3	012019257
1,2x8X200	11,60	3	3	012019260
1,6x10x200	13,20	3	3	012019266

1201EN/K



SxAxL mm	€	Hand	Units	Code
0,8x4x30	6,70	3	3	012019303
1,2x6,5x30	7,15	3	3	012019306

1202E/K



PHxDxL mm	€	Hand	Units	Code
0x3x60	4,80	5	5	012029203
0x3X100	5,35	5	5	012029206
1x4,5x80	6,15	5	5	012029209
1x4,5x120	6,90	5	5	012029212
2x6x100	8,20	5	5	012029218
2x6x150	8,90	5	5	012029221
3x8x150	11,20	3	3	012029224
4x9,5x200	14,30	3	3	012029227

1202EN/K



PHxDxL mm	€	Hand	Units	Code
1x4,5x30	6,75	3	3	012029303
2x6x30	7,15	3	3	012029306

1204E/K



SxDxL mm	€	Hand	Units	Code
0,4x2,5x60	4,80	5	5	012049103
0,6x3x75	4,90	5	5	012049106
0,5x3x100	5,20	5	5	012049109
0,8x4x100	5,60	5	5	012049112
0,8x4x125	5,95	5	5	012049115
1,0x5x125	6,70	5	5	012049118
1,0x5x150	7,45	5	5	012049121
1,2x6,5x150	8,20	5	5	012049124

1207E TX/K



Type	€	Hand	Units	Code
T5	7,15	5	5	012079105
T6	7,85	5	5	012079106
T7	7,95	5	5	012079107
T8	8,05	5	5	012079108
T9	8,40	5	5	012079109
T10	9,40	5	5	012079110
T15	9,60	5	5	012079115
T20	9,80	5	5	012079120
T25	10,10	5	5	012079125
T27	10,60	5	5	012079127
T30	10,70	5	5	012079130
T40	12,70	2	2	012079140
T45	13,80	2	2	012079145

1208E RTX/K



Type	€	Hand	Units	Code
T9	8,50	5	5	012089109
T10	9,50	5	5	012089110
T15	10,10	5	5	012089115
T20	10,30	5	5	012089120
T25	10,50	5	5	012089125
T27	11,10	5	5	012089127
T30	11,60	5	5	012089130
T40	13,70	2	2	012089140

1209E PZ/K



Type	€	Hand	Units	Code
PZ 0	5,90	5	5	012099200
1	7,60	5	5	012099203
2	9,50	5	5	012099206
3	14,10	3	3	012099209
4	15,90	3	3	012099212



1209EN-PZ/K



	€	U	Icon
1	6,75	3	012099303
2	7,15	3	012099306

1253



SxAxL mm	€	U	Icon
0,5x3,5x100	10,60	5	012530001

1254



SxAxL mm	€	U	Icon
0,5x3x44	11,50	5	012540001

1260K



SxAxL	€	U	Icon
0,4x2,5x50	6,40	5	012609003
0,4x2,5x75	6,55	5	012609006
0,5x3x75	6,95	5	012609009
0,5x3x100	7,05	5	012609012
0,6x3,5x75	7,15	5	012609018
0,6x3,5x100	7,25	5	012609021
0,8x4x100	8,05	5	012609030
0,8x4x125	8,50	5	012609033
0,8x4x150	9,00	5	012609036
1x5,5x100	9,10	5	012609039
1x5,5x150	10,20	5	012609042
1,5x6,5x100	10,70	5	012609048
1,2x6,5x150	11,40	5	012609051
1,2x8x150	14,10	3	012609057
1,2x8x200	14,80	3	012609060
1,6x10x200	17,80	3	012609066

1260NK



SxAxL mm	€	U	Icon
0,8x4x30	8,35	5	012609103
1,2x6,5x30	9,20	5	012609106

1260EK



SxAxL mm	€	U	Icon
1,2x6,5x150	15,00	3	012609156
1,2x8x175	18,50	3	012609157
1,6x10x200	21,20	2	012609159
2x12x250	24,70	2	012609162

1262K



PHxDxL mm	€	U	Icon
0x3x60	6,95	5	012629003
0x3x100	7,35	5	012629006
1x4,5x80	9,00	5	012629009
1x4,5x120	9,90	5	012629012
2x6x100	10,90	5	012629018
2x6x150	11,80	5	012629021
3x8x150	15,50	3	012629024
4x10x200	19,60	3	012629027

1262NK



PHxDxL	€	U	Icon
1x4,5x30	8,35	5	012629103
2x6x30	9,20	5	012629106

1262EK



PHxDxL mm	€	U	Icon
2x6x150	14,80	3	012629153
3x8x175	18,10	3	012629156
4x10x200	23,20	3	012629159

1264K



SxDxL mm	€	U	Icon
0,5x2,5x60	6,70	5	012649003
0,6x3x75	7,20	5	012649006
0,6x3x100	7,30	5	012649009
0,8x4x100	8,20	5	012649012
0,8x4x125	8,50	5	012649015
1x5x125	9,35	5	012649018
1x5x150	10,10	5	012649021
1,2x6,5x150	11,80	5	012649024

1267TKK



T	€	U	Icon
T5	9,55	5	012679005
T6	9,80	5	012679006
T7	10,30	5	012679007
T8	10,60	5	012679008
T9	11,40	5	012679009
T10	11,50	5	012679010
T15	12,10	5	012679015
T20	12,90	5	012679020
T25	13,50	5	012679025
T27	14,80	5	012679027
T30	15,40	5	012679030
T40	17,80	2	012679040
T45	18,80	2	012679045

1268RTKK



T	€	U	Icon
T9	12,10	3	012689009
T10	12,70	3	012689010
T15	13,00	3	012689015
T20	13,60	3	012689020
T25	14,10	3	012689025
T27	15,70	3	012689027
T30	15,90	3	012689030
T40	18,40	2	012689040

1269PZK



PZ	€	U	Icon
0	8,05	5	012699000
1	10,10	5	012699001
2	11,90	5	012699002
3	17,30	3	012699003
4	21,40	3	012699004

1269N/PZK



PZ	€	U	Icon
1	8,35	5	012699011
2	9,20	5	012699012

1290K



SxAxL mm	€	🔧	📦
0,4x2,5x50	8,70	5	012909003
0,4x2,5x75	8,80	5	012909006
0,5x3x75	9,10	10	012909009
0,5x3x100	9,60	10	012909012
0,6x3,5x75	9,80	10	012909018
0,6x3,5x100	9,95	10	012909021
0,8x4x100	10,20	10	012909030
0,8x4x125	10,30	10	012909033
0,8x4x150	11,20	10	012909036
1x5,5x100	11,30	10	012909039
1x5,5x150	12,50	10	012909042
1,2x6,5x100	14,00	10	012909048
1,2x6,5x150	14,70	10	012909051
1,2x8x150	18,20	3	012909057
1,2x8x200	19,00	3	012909060
1,6x10x200	22,10	3	012909066

1290NK



SxAxL mm	€	🔧	📦
0,8x4x30	10,90	5	012909103
1,2x6,5x30	12,10	5	012909106

1290K/INOX



SxAxL mm	€	🔧	📦
0,4x2,5x50	10,80	4	012909403
0,5x3x75	11,00	4	012909409
0,8x4x100	11,60	4	012909430
1,0x5,5x150	14,50	4	012909442
1,2x6,5x150	16,70	4	012909451

1292K



PHxDxL mm	€	🔧	📦
0x3x60	7,95	10	012929003
0x3x100	9,00	5	012929006
1x4,5x80	10,70	10	012929009
1x4,5x120	11,90	10	012929012
2x6x100	13,80	10	012929018
2x6x150	15,20	10	012929021
3x8x150	19,10	3	012929024
4x10x200	27,00	3	012929027

1292NK



PHxDxL mm	€	🔧	📦
1x4,5x30	10,50	5	012929103
2x6x30	11,20	5	012929106

1292K/INOX



PHxDxL mm	€	🔧	📦
0x3x60	10,30	4	012929403
1x4,5x80	12,00	4	012929409
2x6x100	14,50	4	012929418

1294K



SxDxL mm	€	🔧	📦
0,5x2,5x60	7,65	5	012949003
0,6x3x75	8,40	5	012949006
0,8x4x100	9,95	5	012949012
1x5x125	12,60	5	012949018

1298RTXK



	€	🔧	📦
T9	16,90	5	012989009
T10	17,40	5	012989010
T15	18,60	5	012989015
T20	19,10	5	012989020
T25	19,30	5	012989025
T27	20,00	5	012989027
T30	21,30	5	012989030
T40	23,00	2	012989040

1299PZK



PZ	€	🔧	📦
0	11,50	5	012999000
1	13,40	5	012999003
2	18,00	5	012999006

1299N/PZK



PZ	€	🔧	📦
1	12,70	5	012999021
2	14,10	5	012999024

1472VW



L mm	€	🔧	📦
200	53,50	1	014720051

1473P



A Max mm	€	🔧	📦
53	39,00	1	014730020

1497BS

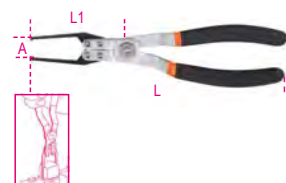

L mm	€	🔧	📦
230	26,00	1	014970190

1497SS



L mm	€	🔧	📦
245	24,00	1	014970195

Beta
Quality Tools

1497RC



1497RC € 85,00 1 014970351

1600Q 8



1600Q 8 € 33,00 1 016000008

1600Q 10



1600Q 10 € 42,50 1 016000010

1603K



mm² 0÷8 € 16,80 5 016039001

1603BK



mm² 0÷8 € 75,50 2 016039010

1651DGTB

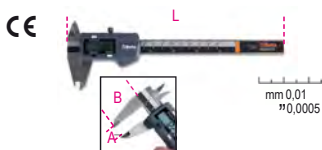

A Max mm	€		
150	125,00	1	016510211
200	163,00	1	016510212
300	212,50	1	016510213

Beta

Quality Tools

1651DGTB/IP

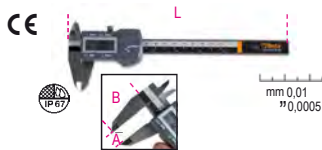

A Max mm 150 € 204,50 1 016510711

1691BM



L m	€		
5	18,80	1	016910205
8	27,50	1	016910208
10	34,50	1	016910210

1691MG



L m	€		
5	17,10	1	016910405
8	24,40	1	016910408
10	26,00	1	016910410

1692



L m	€		
2	9,20	5	016920052
3	11,70	5	016920053
5	16,60	5	016920055
8	24,10	5	016920058

1693

CE



IP54



H mm 100 € 146,50 1 016930020

1729CG



L mm 310 € 28,50 2 017290200

1729DM 450

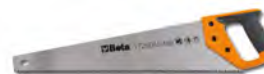

L mm 450 € 33,50 4 017290450

1741U



Ø mm	2,4	3	3,2	4	4,8
Aluminium	•	•	•	•	•
Staal	•	•	•	•	
Roestvast staal	•	•	•	•	

1741U € 52,50 1 017410450



1741B



250 mm

Ø mm	2,4	3,2	4	4,8	5
Aluminium
Steel
Stainless steel

1741B € 44,50 1 017410000

1760K

CE



180 mm

CAT III-1000V

1760K € 43,00 1 017600140

1762K



Ø mm
2-2,5-3
3,5-4-4,5

€ 36,00 2 017629001

1771



18 mm

170 mm

1771 € 11,80 10 017710000

1770BM



L mm 140 € 16,20 10 017700050

1771BM



L mm 170 € 26,50 10 017710050

1771HD



L mm 190 € 29,50 5 017710100

1772R



L mm 125 € 22,40 5 017720006

1773A



L mm 180 € 23,00 10 017730000

1773S



L mm 190 € 15,00 1 017730100

1777BMT



L mm 170 € 35,00 5 017770050

1777T



L mm 160 € 32,00 5 017770030

1778MT



L mm 180 € 125,00 1 017780055

1783



L mm 215 € 18,40 5 017830021
240 € 20,30 5 017830024

1820



€ 50,00 1 018200003
1820 30 30W
L = 210mm
€ 60,00 1 018200006
1820 60 60W
L = 220mm
€ 88,00 1 018200008
1820 80 80W
L = 260mm

Beta

1822



1822 120	135,00	1	018220012
120W			
LxA = 250x125 mm			
1822 180	145,00	1	018220018
180W			
LxA = 250x125mm			
1822 320	180,00	1	018220032
320W			
LxA = 250x140mm			

1833XSW

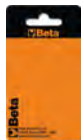

L mm	€		
145	49,00	1	018330011

1833S



L mm	€		
150	43,00	1	018330002

1833M



L mm	€		
162	59,00	1	018330003

1833MW



L mm	€		
160	85,00	1	018330013

Beta

1833L



L mm	€		
196	88,00	1	018330004

1833XL



L mm	€		
300	110,00	1	018330005

1833L/USB



L mm	€		
240	128,50	1	018330054

1836AW



1836AW	79,50	1	018360051
--------	-------	---	-----------

1836B



1836B	146,50	1	018360200
-------	--------	---	-----------

1837F



L mm	€		
460	93,50	1	018370050

1837F/USB



L mm	€		
460	138,00	1	018370060

1838COB



1838COB	100,50	1	018380010
---------	--------	---	-----------



1838P



1838P € 88,00 1 018380005

1838POCKET



L mm 98 € 74,00 1 018380080

1838SLIM

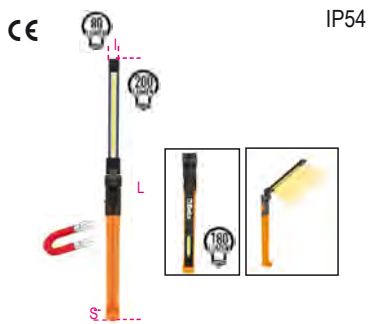

L mm 307 € 79,00 1 018380221

1838SW



L mm 260 € 105,50 1 018380142

1839BRW



L mm 101 € 104,00 1 018390002

1860M

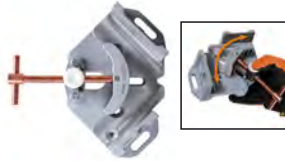

L max mm 30 € 99,00 1 018600301

1875SP/K3



1875SP/K3 € 19,00 1 018750010

1949F2



g 125 € 20,80 1 019490028

1949XS



g 20 € 9,00 25 019490025

6888B1/4

Blisterverpakking voor 1/4" dopsleutels



6888B1/4 € 0,75 50 068880900

6888B3/8

Blisterverpakking voor 3/8" dopsleutels



6888B3/8 € 0,88 50 068880910

6888B1/2

Blisterverpakking voor 1/2" dopsleutels



6888B1/2 € 0,96 50 068880920

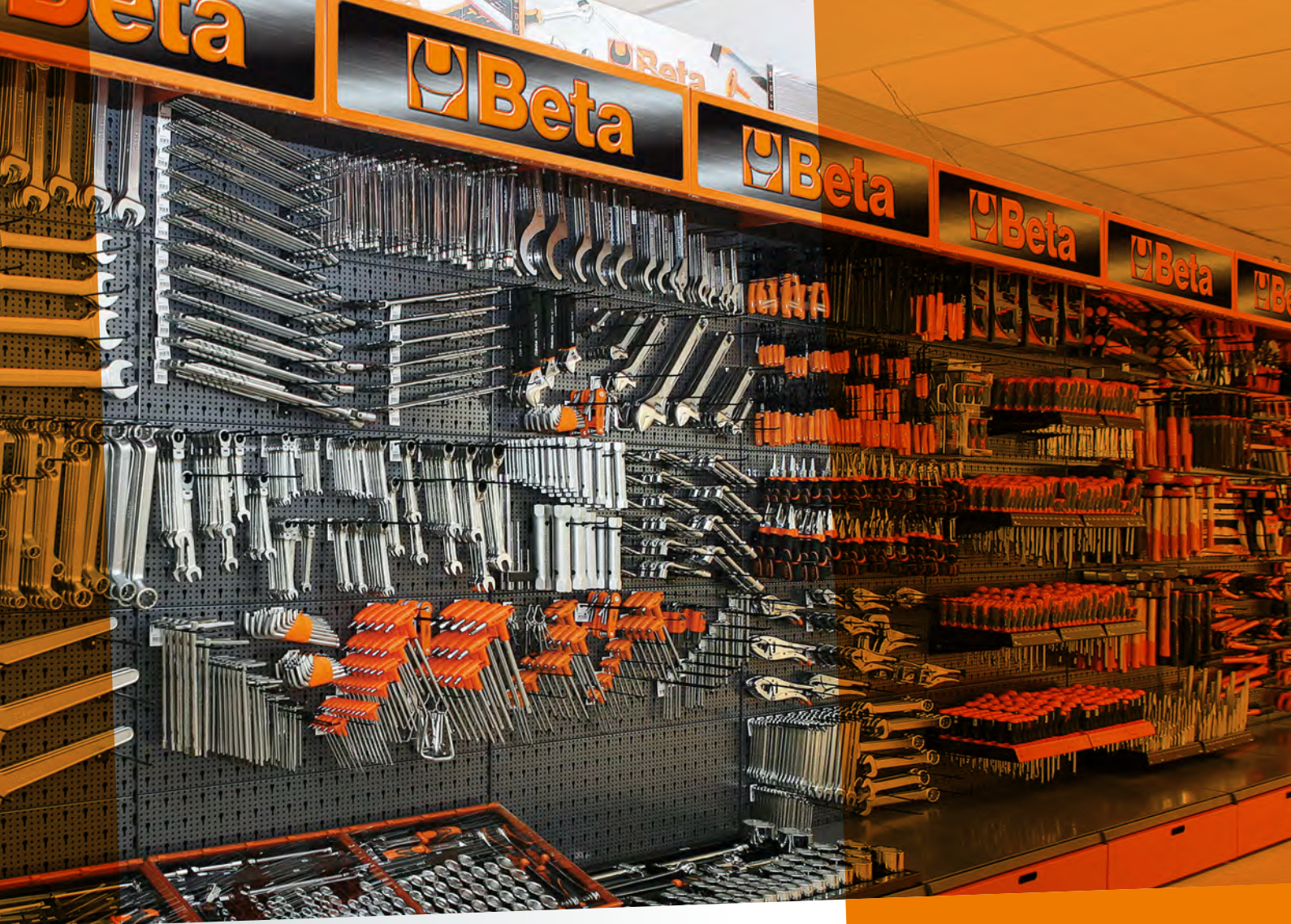

VERKOOPWANDEN

SHOP
in Shop



ONTWERP JE EIGEN PRESENTATIE

www.beta-tools.com/planner3d/

38/DS1

Wand display met 75 pendrijvers en beitels



495x260x332 mm

Display met assortiment
38/DS1 € 728,00 1 000380701

	n.	
30 Ø 2 - 3 - 4 - 5 - 6 mm	5	
31 Ø 2 - 3 - 4 - 5 - 6 - 8 - 10 mm	5	
32 Ø 3 - 4 - 5 mm	5	

Leeg display
38/DVS1 € 141,00 1 000380751

38/DS2

Wand display met 65 pendrijvers en beitels

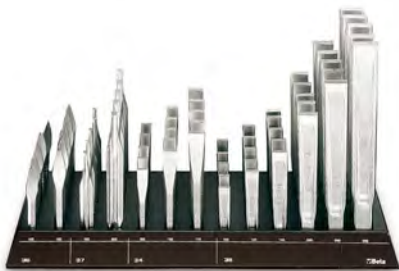

495x260x332 mm

Display met assortiment
38/DS2 € 1.475,00 1 000380702

	n.	
34 125 - 150 - 175 mm	5	
35 100 - 125 - 150 - 200 - 250 - 300 mm	5	
36 125 - 150 mm	5	
37 150 - 200 mm	5	

Leeg display
38/DVS2 € 141,00 1 000380752

942BX/DG

Wand display met 43 dopschroeven-draaiers, korte uitvoering



330x260x332 mm

Display met assortiment
942BX/DG € 835,00 1 009420701

	n.	
942BX 5 - 5,5 mm	3	
6 - 7 mm	6	
8 - 9 - 10 mm	5	
11 mm	2	
12 mm	3	
13 mm	5	

Leeg display
942BX/DVG € 117,00 1 009420751

943BX/DG

Wand display met 43 dopschroeven-draaiers, lange uitvoering



330x260x332 mm

Display met assortiment
943BX/DG € 897,00 1 009430701

	n.	
943BX 5 - 5,5 mm	3	
6 - 7 mm	6	
8 - 9 - 10 mm	5	
11 mm	2	
12 mm	3	
13 mm	5	

Leeg display
943BX/DVG € 117,00 1 009430751

944BX/DG

Wanddisplay met 43 dopschroevendraaiers, lang model



330x260x332 mm

Display met assortiment
944BX/DG € 1.002,00 1 009440701

	n.	
944BX 5 - 5,5 mm	3	
6 - 7 mm	6	
8 - 9 - 10 mm	5	
11 mm	2	
12 mm	3	
13 mm	5	

Leeg display
944BX/DVG € 117,00 1 009440751

943MQ/BG

Wand display met 30 dopschroeven-draaiers



⚡ 1000 V ⚡

330x260x332 mm

Display met assortiment
943MQ/BG € 637,00 1 009430281

	n.	
943MQ 5,5 - 6 - 7 - 8 - 10 - 13 mm	5	

Leeg display
943BG-MQ/DV € 117,00 1 009430285

1203/E1P

Wand display
met 82 schroevendraaiers



495x260x310 mm

Display met assortiment
1203E/E1P € 511,00 1 012031301

		n.
● 1201	0,4x2,5x50 - 0,5x3x75 - 0,6x3,5x100 0,8x4x100 - 0,8x4x125 mm	7
	1,0x5,5x100 - 1,0x5,5x150 - 1,2x6,5x150 mm	6
	1,2x8x150 mm	5
⊕ 1202	PH0x3x60 mm	7
	PH1x4,5x80 - PH2x6x100 mm	6
	PH3x8x150 mm	5

Leeg display
1203E/EV1P € 144,50 1 012031351

1203/E4P

Wand display
met 85 schroevendraaiers



495x260x310 mm

Display met assortiment
1203E/E4P € 495,00 1 012031304

		n.
● 1201	0,4x2,5x50 - 0,5x3x75 - 0,8x4x125 mm	7
	1,0x5,5x100 - 1,0x5,5x150 - 1,2x6,5x150 mm	6
● 1204	0,4x2,5x60 - 0,5x3x100 - 0,8x4x100 mm	7
	1,0x5x125 mm	6
⊕ 1209PZ	PZ0x3x60 mm	7
	PZ1x4,5x80 - PZ2x6x100 mm	6

Leeg display
1203E/EV4P € 144,50 1 012031354

1203/E5P

Wand display
met 82 schroevendraaiers



495x260x310 mm

Display met assortiment
1203E/E5P € 523,00 1 012031305

		n.
⊕ 1202	PH0x3x60 mm	7
	PH1x4,5x80 - PH1x4,5x120 PH2x6x100 - PH2x6x150 mm	6
	PH3x8x150 mm	5
● 1204	0,4x2,5x60 - 0,5x3x100 - 0,8x4x100 mm	7
	1,0x5x125 mm	6
⊕ 1209PZ	PZ0x3x60 mm	7
	PZ1x4,5x80 - PZ2x6x100 mm	6

Leeg display
1203E/EV5P € 144,50 1 012031355

1203/E10P

Wand display
met 80 schroevendraaiers



495x260x310 mm

Display met assortiment
1203E/E10P € 715,00 1 012031310

		n.
⊕ 1207TX	T6	4
	T7	3
	T8	7
	T9 - T10 - T15 - T20 - T25	6
	T27 - T30	3
⊕ 1208RTX	T9 - T10	3
	T15 - T20 - T25	6
	T27 - T30	3

Leeg display
1203E/EV10P € 144,50 1 012031360

1263/E78

Ophangbord met 78 schroevendraaiers



495x260x310 mm

Display met assortiment
1263/E78 € 670,00 1 012630510

● 1260	2,5x75-3x75-3,5x100 mm	7
	4x100-4x125-5,5x100-5,5x150-6,5x150 mm	6
	8x150 mm	4
⊕ 1262	PH0x60 mm	7
	PH1x80-PH2x100 mm	6
	PH3x150	4

Leeg display
1263/EV78 € 132,50 1 012630511

1263/E74

Wand display
met 74 schroevendraaiers



495x260x310 mm

Display met assortiment
1263/E74 € 638,00 1 012630540

● 1264	2,5x60 mm	7
	3x75 mm	3
	3x100 - 4x100 mm	4
	4x125 - 5x150 mm	2
	5x125 - 6,5x150 mm	4
⊕ 1262	PH 8x150	3
	PH 3x60 - 3x100 mm	7
	PH 4,5x80 - 4,5x120 mm	6
	PH 6x100 mm	10
	PH 6x150 mm	5

Leeg display
1263/EV74 € 132,50 1 012630541

1263/E85

Wand display met 85 schroevendraaiers



495x260x377 mm

Display met assortiment
1263/E85 € 742,00 1 012630550

		n.
● 1260	2,5x50 mm	7
	2,5x75 mm	6
	3x75 - 3x100 - 3,5x100 mm	7
	4x100 - 4x125 - 5,5x125	6
	5,5x150 - 6,5x150 mm	4
● 1260E	8x150 mm	4
	10x200 mm	3
	12x250 mm	2
	4x30 - 6,5x30 mm	6

Leeg display
1263/EV85 € 132,50 1 012630551

1263/E50

Wand display met 50 schroevendraaiers



330x260x269 mm

Display met assortiment
1263/E50 € 396,00 1 012630570

		n.
● 1264	2,5x60 - 3x75 - 3x100 mm	7
	4x100 - 4x125 - 5x125 - 5x150 mm	6
	6,5x150 mm	5

Leeg display
1263/EV50 € 117,00 1 012630571

1263/E39

Wand display met 39 schroevendraaiers



330x260x257 mm

Display met assortiment
1263/E39 € 512,00 1 012630595

		n.
⊕ 1268RTX	T9x60 - T10x80 - T15x80	6
	T20x100 - T25x100 mm	4
	T27x115 mm	3
	T30x115 mm	2
	T40x130 mm	2

Leeg display
1263/EV39 € 117,00 1 012630596

1263/E70

Wand display met 70 schroevendraaiers



495x260x327 mm

Display met assortiment
1263/E70 € 733,00 1 012630560

		n.
⊕ 1262	PH0x60 - PH0x100 mm	7
	PH1x80 - PH1x120 mm	6
	PH2x100 mm	9
	PH2x150 - PH3x150 mm	5
	PH4x200 mm	4
⊕ 1262E	PH2x150 mm	5
	PH3x175 mm	4
⊕ 1262N	PH1x30 - PH2x30 mm	6

Leeg display
1263/EV70 € 132,50 1 012630561

1263/E62

Wand display met 62 schroevendraaiers



495x260x257 mm

Display met assortiment
1263/E62 € 717,00 1 012630590

		n.
⊕ 1267TX	T5	5
	T6	6
	T7	5
	T8	6
	T9	5
	T10 - T15 - T20	6
	T25	5
	T27 - T30	4
	T40 - T45	2

Leeg display
1263/EV62 € 132,50 1 012630591

1263/E40

Wand display met 40 schroevendraaiers



330x260x327 mm

Display met assortiment
1263/E40 € 449,00 1 012630580

		n.
⊕ 1269	PZ0x60 mm	7
	PZ1x80 mm	6
	PZ2x100 - PZ3x150 - PZ4x200 mm	5
⊕ 1269N	PZ1x30 - PZ2x30 mm	6

Leeg display
1263/EV40 € 117,00 1 012630581

1273MQ/E1

Wand display met 40 schroevendraaiers



1000 V

330x260x332 mm

Display met assortiment
1273MQ/E1 € 539,00 1 012730312

		n.
1272MQ	PH0x60 - PH1x80 mm	5
	PH2x100 mm	3
	PH3x150 mm	2
1274MQ	3x100 - 4x100 - 5,5x125 - 6,5x150 mm	5
	8x175 mm	3
	10x200 mm	2

Leeg display
1273BG-MQ/DV € 117,00 1 012730651

1273MQ/E4

Wand-display met 43 schroevendraaiers



1000 V

330x260x332 mm

Display met assortiment
1273MQ/E4 € 718,00 1 012730315

		n.
1272MQF	4,5x80 - 6x100 mm	3
1274MQF	3,5x100 - 4,5x100 - 5,5x125 - 6,5x150 mm	3
1275MQ/C	4,5x80 - 6x100 mm	5
1276MQ/C	4,5x80 - 6x100 mm	5
1279MQ/F	4,5x80 mm	3
	6x100 mm	2

Leeg display
1273BG-MQ/DV4 € 117,00 1 012730655

1293BX/DA

Wand display met 90 schroevendraaiers



495x260x332 mm

Display met assortiment
1293BX/DA € 1.012,00 1 012930701

		n.
1290	3x75 - 3,5x100 - 4x100 - 4x125 5,5x100 - 5,5x150 mm 6,5x150 mm	7
	8x150 mm	6
	10x200 mm	3
1290N	4x30 - 6,5x30 mm	2
1292	PH0x60 - PH1x80 mm	3
	PH2x100 mm	7
	PH3x150 mm	6
1292N	PH1x30 - PH2x30 mm	5
		3

Leeg display
1293BX/DVA € 133,50 1 012930751

1293BX/DD

Wand display met 48 schroevendraaiers



330x260x332 mm

Display met assortiment
1293BX/DD € 485,00 1 012930704

		n.
1294	2,5x60 - 3x75 - 3x100 - 4x100 4x150 - 5x125 mm 6,5x150 mm	7
		6

Leeg display
1293BX/DVD € 118,00 1 012930754

1293BX/DE

Wand display met 42 schroevendraaiers



330x260x332 mm

Display met assortiment
1293BX/DE € 713,00 1 012930705

		n.
1299PZ	PZ0x60 - PZ1x80 mm PZ2x100 mm	7
	PZ3x150 - PZ4x200 mm	6
1299N/PZ	PZ1x30 - PZ2x30 mm	5
		6

Leeg display
1293BX/DVE € 118,00 1 012930755

1293BX/DF

Wand display met 59 schroevendraaiers



330x260x332 mm

Display met assortiment
1293BX/DF € 969,00 1 012930706

		n.
1297TX	T6 - T8 - T10 - T15 - T20 - T25 T27 - T30 T40	7
		6
		5

Leeg display
1293BX/DVF € 118,00 1 012930756

C68

Beta wand display



1000x560x2200 mm

		€		
C68/1	1 m	2.510,00	1	068000001
C68/2	2 m	4.370,00	1	068000002
C68/3	3 m	6.230,00	1	068000003
C68/4	4 m	8.090,00	1	068000004
C68/5	5 m	9.950,00	1	068000005
C68/6	6 m	11.810,00	1	068000006
C68/7	7 m	13.670,00	1	068000007
C68/8	8 m	15.530,00	1	068000008
C68/9	9 m	17.390,00	1	068000009
C68/10	10 m	19.250,00	1	068000010

C68N

Beta wand display, leeg



1000x560x2200 mm

		€		
C68N/1	1 m	2.165,00	1	068000031
C68N/2	2 m	4.030,00	1	068000032
C68N/3	3 m	5.890,00	1	068000033
C68N/4	4 m	7.750,00	1	068000034
C68N/5	5 m	9.610,00	1	068000035
C68N/6	6 m	11.470,00	1	068000036
C68N/7	7 m	13.330,00	1	068000037
C68N/8	8 m	15.190,00	1	068000038
C68N/9	9 m	17.050,00	1	068000039
C68N/10	10 m	18.910,00	1	068000040

C68 G

"Gondel" vloer display



1000x1120x1600 mm

		€		
C68G/1	1 m	2.300,00	1	068000051
C68G/2	2 m	4.240,00	1	068000052
C68G/3	3 m	6.190,00	1	068000053
C68G/4	4 m	8.130,00	1	068000054

C88 R/1

Robur wand display



1000x560x2200 mm

		€		
C88R/1	1 m	2.435,00	1	088000001

C88NR/1

Robur wanddisplay, leeg



1000x560x2200 mm

		€		
C88NR/1	1 m	2.075,00	1	088000031

C88VE

Rek voor verkoopstandaard C88

Geschikt voor het ophangen van rollen ketting artikel 8120



		€		
C88VE		254,00	1	088000120

C88SE

Verkoopwand voor Genovese schakelketting



		€		
C88SE		612,00	1	088000130

1700x600x600 mm



6888

Haken voor de wanden C60 - C61 - C68 - C88

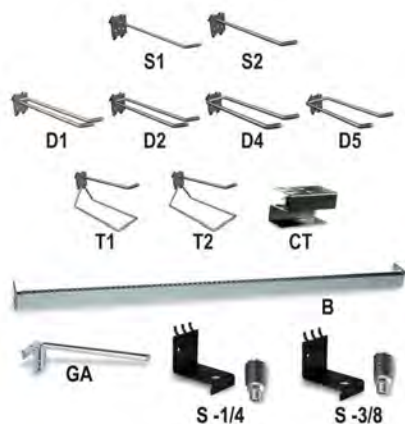

	€		
6888S1	5,45	10	068880011
6888S2	5,75	10	068880012
6888D1	8,25	5	068880021
6888D2	8,40	5	068880022
6888D4	8,80	5	068880024
6888D5	9,00	5	068880025
6888T1	12,00	5	068880031
6888T2	12,00	5	068880032
6888CT	19,80	1	068880044
6888B	69,00	1	068880100
6888GA	28,50	3	068880120
6888S-1/4	48,00	1	068880605
6888S-3/8	48,00	1	068880610

6800 VE

Vitrine voor wand display C68 en C68R/1

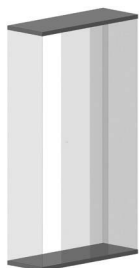

	€		
6800VE/1 1 m	1.240,00	1	068000401
6800VE/2 2 m	1.890,00	1	068000402
6800VE/3 3 m	2.540,00	1	068000403
6800VE/4 4 m	3.180,00	1	068000404
6800VE/5 5 m	3.830,00	1	068000405

TOEBEHOREN



	€		
6800AE	264,00	1	068000145
6800AI	528,00	1	068000140
6800AD/P	873,00	1	068000143



	€		
6800CB/100	294,00	1	068000104
6800FB/100	103,00	1	068000109
6800FO/100	73,00	1	068000108
6800PL	299,00	1	068000137
6800RP/100	94,50	1	068000150
6800GR/37	44,00	1	068000159



	€		
6800PM/40	94,50	1	068000171
6800PM/80	132,50	1	068000172

6600 M/14

154-delig assortiment gereedschappen, met haken zonder paneel



	€		
6600 M/14	2.350,00	1	066000014

6600 M/22

Assortiment van 108 gereedschappen, met haken zonder paneel



	€		
6600 M/22	1.640,00	1	066000022

6600 M/27

25-delig assortiment, met haken zonder paneel



	€		
6600 M/27	1.121,00	1	066000027

6600 M/29

173-delig assortiment gereedschappen, met haken zonder paneel

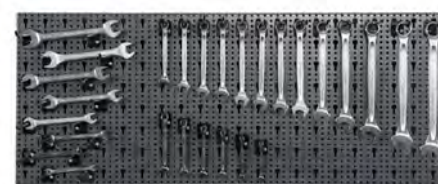

	€		
6600 M/29	2.095,00	1	066000029

6600 M/33

Assortiment van 37 gereedschappen, met haken zonder paneel



	€		
6600 M/33	1.940,00	1	066000033

6600 M/40

100-delig assortiment,
met haken zonder paneel



6600 M/40 € 3.000,00 1 066000040

6600 M/42

Assortiment van 65 gereedschappen,
met haken zonder paneel



6600 M/42 € 1.935,00 1 066000042

6600 M/44

48-delig assortiment gereedschappen,
met haken zonder paneel



6600 M/44 € 1.670,00 1 066000044

6600 M/47

65-delig assortiment,
met haken zonder paneel



6600 M/47 € 1.745,00 1 066000047

6600 M/51

257-delig assortiment gereedschappen
met haken zonder panelen



6600 M/51 € 2.990,00 1 066000051

6600 M/52

176-delig assortiment gereedschappen
met haken zonder paneel



6600 M/52 € 1.935,00 1 066000052

6600 M/58

150-delig assortiment gereedschappen
met haken zonder panelen



6600 M/58 € 2.150,00 1 066000058

6600 M/59

220-delig assortiment gereedschappen,
met haken zonder paneel



6600 M/59 € 2.290,00 1 066000059

6600 M/61

Assortiment van 71 gereedschappen,
met haken zonder paneel

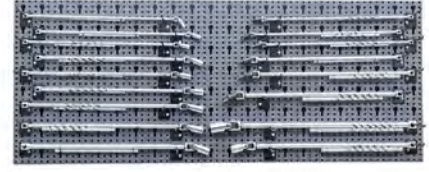

6600 M/61 € 2.880,00 1 066000061

6600 M/62

Assortiment van 28 gereedschappen,
met haken zonder paneel



6600 M/62 € 619,00 1 066000062

6600 M/63

110-delig assortiment gereedschappen
met haken zonder paneel

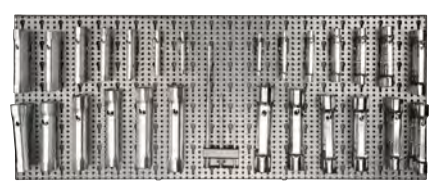

6600 M/63 € 2.600,00 1 066000063

6600 M/73

68-delig assortiment gereedschappen
met haken zonder paneel

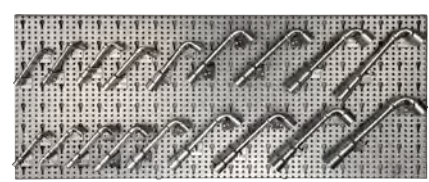

6600 M/73 € 1.595,00 1 066000073

6600 M/112

329-delig assortiment met haken zonder paneel



6600 M/112 € 2.800,00 1 066000112

6600 M/116

306-delig assortiment met haken zonder paneel



6600 M/116 € 2.620,00 1 066000116

6600 M/120

163-delig assortiment, met haken zonder paneel



6600 M/120 € 1.830,00 1 066000120

6600 M/125

133-delig assortiment, met haken zonder paneel



6600 M/125 € 1.580,00 1 066000125

6600 M/126

58-delig assortiment, met haken zonder paneel



6600 M/126 € 1.016,00 1 066000126

6600 M/131

92-delig assortiment, met haken zonder paneel



6600 M/131 € 3.180,00 1 066000131

6600 M/174

Assortiment van 13 gereedschappen, met haken zonder paneel



6600 M/174 € 4.140,00 1 066000174

6600 M/175

Assortiment van 12 gereedschappen, met haken zonder paneel



6600 M/175 € 3.480,00 1 066000175

6600 M/217

74-delig assortiment gereedschappen, met haken zonder paneel



6600 M/217 € 3.090,00 1 066000217

6600 M/218

58-delig assortiment gereedschappen, met haken zonder paneel

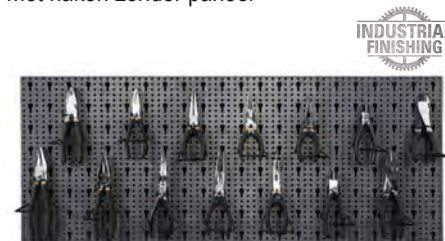

6600 M/218 € 1.595,00 1 066000218

6600 M/222

74-delig assortiment gereedschappen, met haken zonder paneel

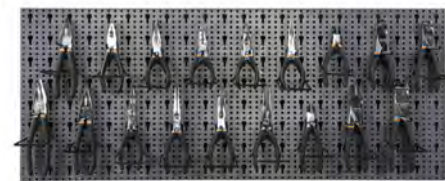

6600 M/222 € 2.510,00 1 066000222

6600 M/223

58-delig assortiment gereedschappen, met haken zonder paneel



6600 M/223 € 2.080,00 1 066000223

6600 M/230

78-delig assortiment,
met haken zonder paneel



6600 M/230 € 2.590,00 1 066000230

6600 M/236

31-delig assortiment met haken zonder paneel



6600 M/236 € 1.500,00 1 066000236

6600 M/241

Assortiment van 43 gereedschappen,
met haken zonder paneel



6600 M/241 € 1.290,00 1 066000241

6600 M/242

91-delig assortiment gereedschappen,
met haken zonder paneel



6600 M/242 € 3.110,00 1 066000242

6600 M/253

60-delig assortiment gereedschappen,
met haken zonder paneel



6600 M/253 € 2.190,00 1 066000253

6600 M/311

Assortiment van 114 gereedschappen,
met haken zonder paneel



6600 M/311 € 1.300,00 1 066000311

6600 M/315

149-delig assortiment,
met haken zonder paneel



6600 M/315 € 2.165,00 1 066000315

6600 M/320

98-delig assortiment,
met haken zonder paneel



6600 M/320 € 1.980,00 1 066000320

6600 M/326

155-delig assortiment met haken zonder
paneel

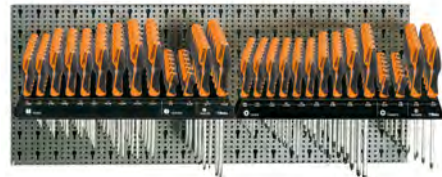

6600 M/326 € 1.475,00 1 066000326

6600 M/327

101-delig assortiment met haken zonder
paneel



6600 M/327 € 1.230,00 1 066000327

6600 M/330

110-delig assortiment met haken zonder
paneel



6600 M/330 € 1.009,00 1 066000330

6600 M/371

162-delig assortiment gereedschappen,
met haken zonder paneel



6600 M/371 € 1.225,00 1 066000371

6600 M/380

assortiment van 71 gereedschappen,
inclusief haken zonder paneel



6600 M/380 € 751,00 1 066000380

6600 M/406

107-delig assortiment gereedschappen,
met haken zonder paneel



6600 M/406 € 1.365,00 1 066000406

6600 M/417

Assortiment van 43 gereedschappen,
met haken zonder paneel



6600 M/417 € 1.205,00 1 066000417

6600 M/423

Assortiment van 30 gereedschappen, met
haken zonder paneel



6600 M/423 € 1.143,00 1 066000423

6600 M/424

Assortiment van 36 gereedschappen, met
haken zonder paneel



6600 M/424 € 1.245,00 1 066000424

6600 M/427

24-delig assortiment,
met haken zonder paneel



6600 M/427 € 1.325,00 1 066000427

6600 M/430

29-delig assortiment,
met haken zonder paneel



6600 M/430 € 1.290,00 1 066000430

6600 M/440

140-delig assortiment,
met haken zonder paneel

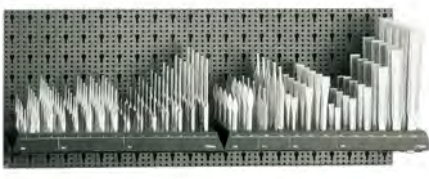

6600 M/440 € 2.205,00 1 066000440

6600 M/456

Assortiment van 41 gereedschappen,
met haken zonder paneel



6600 M/456 € 1.725,00 1 066000456

6600 M/465

Assortiment van 36 gereedschappen, met
haken zonder paneel



6600 M/465 € 2.195,00 1 066000465

6600 M/480

18-delig assortiment,
met haken zonder paneel



6600 M/480 € 1.380,00 1 066000480

6600 M/485

12-delig assortiment,
met haken zonder paneel



6600 M/485 € 1.007,00 1 066000485

6600 M/510

16-delig assortiment,
met haken zonder paneel



6600 M/510 € 1.325,00 1 066000510

6600 M/532

24-delig assortiment gereedschappen
met haken zonder paneel



6600 M/532 € 1.115,00 1 066000532

6600 M/534

51-delig assortiment met haken zonder paneel



6600 M/534 € 1.850,00 1 066000534

6600 M/542

Assortiment van 53 gereedschappen,
met haken zonder paneel



6600 M/542 € 1.084,00 1 066000542

6600 M/548

Assortiment van 37 gereedschappen,
met haken zonder paneel

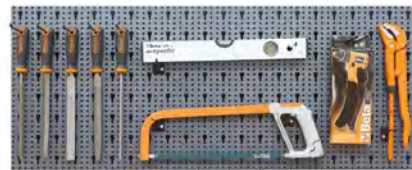

6600 M/548 € 985,00 1 066000548

6600 M/561

Assortiment van 60 gereedschappen,
met haken zonder paneel



6600 M/561 € 1.450,00 1 066000561

6600 M/583

22-delig assortiment gereedschappen
met haken zonder paneel



6600 M/583 € 1.072,00 1 066000583

6600 M/643

assortiment van 90 gereedschappen,
met haken zonder paneel



6600 M/643 € 2.055,00 1 066000643

6600 M/650

28-delig assortiment,
met haken zonder paneel



6600 M/650 € 3.050,00 1 066000650

6600 M/657

Assortiment van 17 gereedschappen,
met haken zonder paneel



6600 M/657 € 2.405,00 1 066000657

6600 M/658

14-delig assortiment gereedschappen
met haken zonder paneel

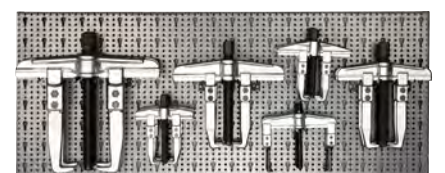

6600 M/658 € 2.660,00 1 066000658



6600 M/716

64-delig assortiment met haken zonder paneel



6600 M/716 € 2.890,00 1 066000716

6600 M/813

Assortiment van 25 gereedschappen, met haken zonder paneel



6600 M/813 € 1.340,00 1 066000813

6600 M/842

Assortiment van 36 gereedschappen, met haken zonder paneel



6600 M/842 € 1.710,00 1 066000842

6600 M/852

Assortiment van 560 harde slijpschijven, met haken zonder paneel



6600 M/852 € 1.620,00 1 066000852

6600 M/856

Assortiment van 560 harde slijpschijven, met haken zonder paneel



6600 M/856 € 1.700,00 1 066000856

6600 M/857

Assortiment van 560 harde slijpschijven, met haken zonder paneel



6600 M/857 € 1.770,00 1 066000857

6600 M/871

Assortiment van 120 slijpschijven met haken zonder paneel



6600 M/871 € 763,00 1 066000871

6600 M/878

Assortiment van 100 slijpschijven met haken zonder paneel



6600 M/878 € 706,00 1 066000878

6600 M/881

Assortiment van 410 slijpschijven met metalen standaard



6600 M/881 € 2.000,00 1 066000881



8600 R/11

374-delig Robur assortiment met haken zonder paneel



8600 R/11 € 1.875,00 1 086000011

8600 R/12

Assortiment van 259 kabeltoebehoren, met haken zonder paneel

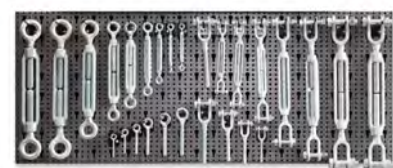

8600 R/12 € 1.870,00 1 086000012



8600 R/13

Assortiment van 230 kabeltoebehoren,
met haken zonder paneel



8600 R/13 € 1.540,00 1 086000013

8600 R/113

Assortiment van 1862 kabeltoebehoren,
met haken zonder paneel



8600 R/113 € 2.125,00 1 086000113

8600 R/114

Assortiment van 1045 kabeltoebehoren,
met haken zonder paneel



8600 R/114 € 2.090,00 1 086000114

8600 R/225

Assortiment van 64 GRADE 8 toebehoren,
met haken zonder paneel



8600 R/225 € 1.425,00 1 086000225

8600 R/412

Assortiment van 348 roestvaststalen kabel
toebehoren,
met haken zonder paneel

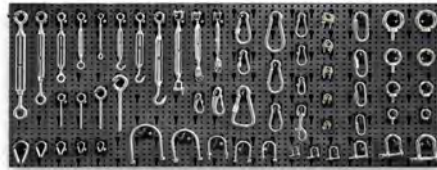

8600 R/412 € 2.110,00 1 086000412

8600 R/511

Assortiment van 11 Genovese ketting op rol,
met display houder



8600 R/511 € 1.750,00 1 086000511

8600 R/601

Assortiment van 50 ratel spanbanden
met rooster, plank en haken,
zonder paneel



8600 R/601 € 1.315,00 1 086000601
C88/R601 € 364,00 1 088000160

8600 R/611

Assortiment van 52 stropen
met rooster, zonder paneel



8600 R/611 € 1.064,00 1 086000611
C88/R611 € 200,00 1 088000161



Beta

VEILIGHEIDSSCHOENEN

LEGENDA



Met antiperforatiezool



Met beschermingsneus



Antistatisch schoeisel



Energieabsorptie van het zitgedeelte



Olie-, koolwaterstof- en oplosmiddelbestendige buitenzool



Antislip buitenzool



Herhaalde buigweerstand > 60.000



Contacthittebestendige buitenzool (300 °C/min.)



Niet-magnetische schoenen, volledig vrij van metalen delen



Schoenen ontwikkeld om een constante afvoer van elektrostatische ladingen van het lichaam van de drager naar de grond te garanderen



Brede schoenen (11) voor meer comfort



Schoenen ontwikkeld om koude-isolatie te bieden (-20 °C)

WAARSCHUWINGEN

Zorg er voor gebruik voor dat het schoeisel voldoet aan uw gebruikseisen en een juiste beschermingsklasse heeft, afhankelijk van type en werkplek. Het door Beta Utensili vervaardigde schoeisel voldoet aan de huidige EUROPESE NORMEN.

De werkgever zorgt ervoor dat er passende persoonlijke beschermingsmiddelen worden verstrekt aan de werknemers die mogelijk worden blootgesteld aan een risico (kenmerken en categorie PBM).

VEROUDERING

Door de vele factoren die een rol spelen (vochtigheid tijdens opslag en structurele veranderingen in materialen in de tijd) kan de exacte houdbaarheid van de schoen niet worden bepaald. Over het algemeen heeft schoeisel dat volledig is gemaakt van polyurethaan of met een buitenzool van polyurethaan een verwachte maximale levensduur van drie jaar vanaf de fabricagedatum. Schoeisel dat volledig van PVC is gemaakt, heeft een verwachte levensduur van vijf jaar vanaf de fabricagedatum; overwegende dat schoeisel met een bovenwerk van leer en schoeisel van rubber, thermoplastisch materiaal en EVA een verwachte maximale levensduur van tien jaar vanaf de fabricagedatum hebben. Dergelijke termijnen zijn van toepassing op nieuw schoeisel, verpakt en opgeslagen onder gecontroleerde omstandigheden, dat wil zeggen, abrupte veranderingen in temperatuur en relatieve vochtigheid vermijden.

EUROPESE NORMEN EN BETEKENIS

EN ISO 20345:2011 - EN ISO 20347:2012

NORM EN ISO 20345:2011

De norm specificeert de testmethoden voor schoeisel dat is ontworpen als PBM.

NORM EN ISO 20347:2012

Deze norm specificeert basis- en aanvullende (optionele) vereisten voor werkschoenen die niet zijn blootgesteld aan mechanische risico's (impact of compressie). Schoeisel volgens EN ISO 20347: 2012 is gemarkeerd met "O" (= Beroepsmatig). Het heeft vrijwel dezelfde kenmerken als het bovenstaande schoeisel, hoewel veiligheidsneuzen of penetratiebestendige inlegzolen niet nodig zijn.

Naast de basisvereisten onder EN ISO 20345: 2011, kan schoeisel ook aan enkele aanvullende vereisten voldoen, die moeten worden geïdentificeerd met symbolen of klassen en die moeten worden vermeld op het etiket dat op de tong van het schoeisel is aangebracht.

EUROPESE NORMEN EN BETEKENIS

EN ISO 20345:2022 - EN ISO 20347:2022

NORM EN ISO 20345:2022

De norm specificeert de basis- en aanvullende (optionele) vereisten voor veiligheidsschoenen voor algemeen gebruik. Schoenen die voldoen aan de norm EN ISO 20345: 2022 is gemarkeerd met de letter "S" (Safety = Veiligheid), ze zijn uitgerust met een neus die is ontworpen om bescherming te bieden tegen schokken van minimaal 200 J en tegen compressie van minimaal 15 kN.

NORM EN ISO 20347:2022

De norm specificeert de basis- en aanvullende (optionele) eisen voor werkschoenen die niet zijn blootgesteld aan mechanische risico's (impact of compressie). Schoeisel dat voldoet aan EN ISO 20347: 2022 is gemarkeerd met de letter "O" (Occupational = Professioneel). Ze zijn qua kenmerken vergelijkbaar met het eerder aangegeven schoeisel, de enige verschillen zijn het ontbreken van de beschermende neus en de anti-lek tussenzool.

Naast de verplichte basiseisen volgens EN ISO 20345:2022 kunnen schoenen ook aan aanvullende eisen voldoen. Deze eisen moeten worden aangegeven met symbolen of klassen en op het schoeisel worden aangegeven.

Informatie voor schoenen met perforatiebestendige inzetstukken

De perforatieweerstand van deze schoen is getest in het laboratorium, door gebruik te maken van gestandaardiseerde nagels en kracht. Nagels met een kleinere diameter en hogere statische of dynamische belastingen gaan gepaard met een hoger risico op perforatie. Onder dergelijke omstandigheden moeten aanvullende preventieve maatregelen worden overwogen. PBM-schoenen zijn momenteel verkrijgbaar met drie verschillende soorten perforatiebestendige inzetstukken. Dit kunnen metalen of niet-metalen inzetstukken zijn en moeten worden gekozen op basis van de risico's die aan het soort werk zijn verbonden. Alle drie de soorten inzetstukken bieden bescherming tegen het risico van perforatie; niettemin heeft elk andere voor- of nadelen, waaronder de volgende:

- **Metalen perforatiebestendig inzetstuk:** de perforatieweerstand wordt minder beïnvloed door de vorm van het scherpe voorwerp (bijv. diameter, geometrie, puntige vorm), maar bedekt niet het hele oppervlak van het onderste deel van de schoen, vanwege beperkingen in de afmetingen nodig voor de productie van de schoenen.
- **Niet-metalen perforatiebestendig inzetstuk:** het is licht, flexibel en biedt een groot dekkinggebied in vergelijking met een metalen exemplaar, maar de perforatieweerstand kan in grotere mate variëren, afhankelijk van de vorm van het scherpe voorwerp (bijv. geometrie, puntige vorm). Type PS biedt meer bescherming tegen objecten met een kleinere diameter dan type PL.

CLASSIFICATIE VAN SCHOENEN

- **Klasse I:** schoenen gemaakt van leer en andere materialen, met uitzondering van volledig rubber en volledig polymeer schoeisel.
- **Klasse II:** schoenen volledig rubberen schoeisel (d.w.z. volledig gevulkaniseerd) of volledig polymeer (d.w.z. volledig gegoten).

BASIS BENODIGDHEDEN

- **Hele schoen:** hoogte bovendeel; hiel gebied; constructieve prestaties van de buitenzool (constructie en sterkte van de boven-/buitenzool); teenbescherming en veiligheidsneus (behalve voor schoenen volgens EN ISO 20347), slipweerstand.
- **Bovenwerk:** eigenschappen van materialen van bovenwerk, voering, tong, binnenzool/binnenzool (scheurvastheid, slijtvastheid, trekeigenschappen, waterdampdoorlaatbaarheid, pH, binnenzool/voetbedabsorptie en de-absorptie).
- **Buitenzool:** constructie- en scheursterkte, slijtvastheid, buigweerstand, weerstand tegen hydrolyse, hechtsterkte tussen de lagen en weerstand tegen koolwaterstofoliën.

PROTECTION CLASS		EN ISO 20345:2011				EN ISO 20347:2012				EN ISO 20345:2011		EN ISO 20347:2012		MINIMALE VEREISTEN WAARDEN
		SB	S1	S2	S3	OB	O1	O2	O3	S4	S5	O4	O5	
	Gesloten hielgebied	0	X	X	X	0	X	X	X	X	X	X	X	
	Neus die bestand is tegen een impact van 200 Joule	X	X	X	X	-	-	-	-	X	X	-	-	
A	Antistatische schoenen	0	X	X	X	0	X	X	X	X	X	X	X	Elektrische weerstand > 100 kΩ ≤ 1000 kΩ
E	Energieabsorptie in hielgebied	0	X	X	X	0	X	X	X	X	X	X	X	> 20 joule
WRU	Waterbestendig tegen penetratie en waterafstotend bovenwerk	0	-	X	X	0	-	X	X	-	-	-	-	Penetratie: <0.2 g x 60 min Absorptie: <30% x 60 min.
P	Perforatieweerstand (metalen inzet P)	0	0	-	X	0	0	-	X	0	X	0	X	> 1100 N
CI	Koude isolatie van binnenzoolcomplex	0	0	0	0	0	0	0	0	0	0	0	0	Temperatuurdaling ≤ 10 °C in een omgeving bij -17 °C gedurende 30'
HI	Warmte-isolatie van binnenzoolcomplex	0	0	0	0	0	0	0	0	0	0	0	0	Temperatuurstijging ≤ 22 °C bij plaatsing op een plaat bij een temperatuur van 150 °C gedurende 30'
HRO	Weerstand tegen heet contact	0	0	0	0	0	0	0	0	0	0	0	0	Contact bij 300 °C gedurende 60" - Smelt niet
WR	Waterbestendigheid	0	0	0	0	0	0	0	0	-	-	-	-	Geen waterpenetratie
FO	Weerstand tegen koolwaterstoffen	0	X	X	X	0	0	0	0	X	X	0	0	Volumetoename zool < 12 %
SRC	Weerstand tegen het slippen van de loopzool	X	X	X	X	X	X	X	X					SRA + SRB vereisten

X	Verplichte vereisten voor beschermingsklasse
O	Optionele vereiste toegevoegd aan verplichte, indien genoemd op markering
-	Niet verplicht vereiste, controleer de markering van de schoen.

Antistatisch schoeisel:

Antistatisch schoeisel moet worden gebruikt wanneer de ophoping van elektrostatische ladingen tot een minimum moet worden beperkt, om het gevaar van verbranding van brandbare stoffen en dampen uit te sluiten en indien het risico van elektrische schokken door onder spanning staande delen moet blijven bestaan. Antistatisch schoeisel biedt geen bescherming tegen elektrische schokken, omdat het alleen een elektrische weerstand creëert tussen de vloer en de voet. Als het gevaar van elektrische schokken niet volledig kan worden uitgesloten, moeten aanvullende voorzorgsmaatregelen worden genomen als onderdeel van een periodiek plan voor ongevallenpreventie op de werkplek. Om aan antistatische vereisten te voldoen, mag het schoeisel niet worden gewijzigd.

Isolerend schoeisel:

Isolerend schoeisel biedt elektrische bescherming tegen onbedoeld contact met spanningen tot 1000 V, op voorwaarde dat de gebruiksomstandigheden de elektrische weerstand niet wijzigen of veranderen onder invloed van vochtigheid. Opgemerkt moet worden dat elektrische weerstand alleen betrekking heeft op de onderkant en niet op de bovenkant van het schoeisel.

Elektrische klassen voor schoenen:

Klasse 00 500V CA of 750V CC

Klasse 0 1000V CA of 1500V CC

Dissipatief schoeisel voor EPA-omgevingen:

Dissipatief schoeisel, dat speciaal is ontworpen voor EPA (ESDS) -omgevingen, zorgt ervoor dat elektrostatische ladingen op een continue en gecontroleerde manier worden afgevoerd van het lichaam van de drager, om elektronische componenten en apparaten te beschermen tegen elektrostatische verschijnselen. De referentiewaarde van grondweerstand volgens CEI EN 61340-5-1: 2016, voor drager / schoeisel / vloer, is <1 × 10⁹ Ω.

CLASSIFICATIE VAN SCHOENEN

- **Klasse I:** schoenen gemaakt van leer en andere materialen, met uitzondering van volledig rubber en volledig polymeer schoeisel.
- **Klasse II:** schoenen volledig rubberen schoeisel (d.w.z. volledig gevulkaniseerd) of volledig polymeer (d.w.z. volledig gegoten).

BASIS BENODIGDHEDEN

- **Hele schoen:** hoogte bovendeel; hiel gebied; constructieve prestaties van de buitenzool (constructie en sterkte van de boven-/buitenzool); teenbescherming en veiligheidsneus (behalve voor schoenen volgens EN ISO 20347), slipweerstand.
- **Bovenwerk:** eigenschappen van materialen van bovenwerk, voering, tong, binnenzool/binnenzool (scheurvastheid, slijtvastheid, trekeigenschappen, waterdampdoorlaatbaarheid, pH, binnenzool/voetbedabsorptie en de-absorptie).
- **Buitenzool:** constructie- en scheursterkte, slijtvastheid, buigweerstand, weerstand tegen hydrolyse, hechtsterkte tussen de lagen en weerstand tegen koolwaterstofoliën.

PROTECTION CLASS	EN ISO 20345:2022											EN ISO 20347:2022						MINIMALE VEREISTEN WAARDEN
	SB	S1	S2	S3	S3L	S3S	S6	S7	S7L	S7S	OB	O1	O2	O3	O3L	O3S		
Class	I o II	I	I	I	I	I	I	I	I	I	I o II	I	I	I	I	I		
Gesloten hielgebied	0	X	X	X	X	X	X	X	X	X	0	X	X	X	X	X		
Neus die bestand is tegen een impact van 200 Joule	X	X	X	X	X	X	X	X	X	X	-	-	-	-	-	-		
Buitenzool met noppen	0	0	0	X	X	X	0	X	X	X	0	0	0	X	X	X		
P Perforatieweerstand (metalen inzet P)	0	0	0	X	-	-	0	X	-	-	0	0	0	X	-	-	Perforation force ≥ 1100N	
PL Perforatieweerstand (niet-metalen inzetstuk, test met spijker, Ø 4,5 mm)	0	0	0	-	X	-	0	-	X	-	0	0	0	-	X	-		
PS Perforatieweerstand (niet-metalen inzetstuk, test met spijker, Ø 3,0 mm)	0	0	0	-	-	X	0	-	-	X	0	0	0	-	-	X		
A Antistatische schoenen	0	X	X	X	X	X	X	X	X	X	0	X	X	X	X	X	Elektrische weerstand > 100 kΩ ≤ 1000 kΩ	
HI Warmte-isolatie van binnenzoolcomplex	0	0	0	0	0	0	0	0	0	0	0	0	0	0	0	0	Temperatuurstijging ≤ 22 °C bij plaatsing op een plaat bij een temperatuur van 150 °C gedurende 30'	
CI Koude isolatie van binnenzoolcomplex	0	0	0	0	0	0	0	0	0	0	0	0	0	0	0	0	Temperatuurdaling ≤ 10 °C in een omgeving bij -17 °C gedurende 30	
E Energy absorption in heel area	0	X	X	X	X	X	X	X	X	X	0	X	X	X	X	X	> 20 Joule	
WR Waterbestendigheid	0	0	0	0	0	0	X	X	X	X	0	0	0	0	0	0	Geen waterpenetratie	
SC Slijtvastheid van scuff cap	0	0	0	0	0	0	0	0	0	0	0	0	0	0	0	0	Geen gat door de hele dikte na 8.000 cycli	
SR Slipweerstand op keramische vloer met glycerine	X	X	X	X	X	X	X	X	X	X	X	X	X	X	X	X	Test op keramische vloer met glycerine.	
WPA Waterpenetratie en -absorptie	0	0	X	X	X	X	-	-	-	-	0	0	X	X	X	X	H2O-absorptie na 60' ≤ 30%	
HRO Weerstand tegen heet contact	0	0	0	0	0	0	0	0	0	0	0	0	0	0	0	0	Contact bij 300 °C gedurende 60" - Smelt niet	
FO Weerstand tegen koolwaterstoffen	0	0	0	0	0	0	0	0	0	0	0	0	0	0	0	0	Volumetoename zool < 12 %	
LG Ladder grip	0	0	0	0	0	0	0	0	0	0	0	0	0	0	0	0	Breedte van centrale buitenzool > 35 mm	

X	Verplichte vereisten voor beschermingsklasse
O	Optionele vereiste toegevoegd aan verplichte, indien genoemd op markering
-	Niet verplicht vereiste, controleer controleer de markering van de schoen.

Gedeeltelijk geleidende schoenen



Gedeeltelijk geleidende schoenen moeten worden gebruikt als het nodig is om elektrostatische ladingen in de kern mogelijke tijd tot een minimum te beperken, b.v. bij het omgaan met explosieven.

Elektrisch geleidende schoenen mogen niet worden gebruikt als het risico op schokken door elektrische apparaten of onder spanning staande onderdelen met wissel- of gelijkspanning niet volledig is uitgesloten. Om ervoor te zorgen dat de schoenen gedeeltelijk geleidend zijn, is gespecificeerd dat het in zijn nieuwe staat een bovengrens van weerstand van 100 kΩ heeft.

Antistatisch schoeisel:

Antistatisch schoeisel moet worden gebruikt wanneer de ophoping van elektrostatische ladingen tot een minimum moet worden beperkt, om het gevaar van verbranding van brandbare stoffen en dampen uit te sluiten en indien het risico van elektrische schokken door onder spanning staande delen moet blijven bestaan. Antistatisch schoeisel biedt geen bescherming tegen elektrische schokken, omdat het alleen een elektrische weerstand creëert tussen de vloer en de voet. Als het gevaar van elektrische schokken niet volledig kan worden uitgesloten, moeten aanvullende voorzorgsmaatregelen worden genomen als onderdeel van een periodiek plan voor ongevallenpreventie op de werkplek. Om aan antistatische vereisten te voldoen, mag het schoeisel niet worden gewijzigd.

De certificaten van de schoenen zijn gecertificeerd volgens de geldende normen en zijn geldig tot het verstrijken ervan.

EN ISO 20345:2011		S1P SRC									
SERIE	ARTIKEL	VEREISTEN				AANBEVOLEN SECTOREN					📄
		AANVULLENDE VEREISTEN			AUTOMOTIVE	BOUW	ELECTRICITEIT	INDUSTRIE	TRANSPORT	INSTALLATIE & LOODGIETERS	
 FLEX	7212G	ESD	X	X	X	X	X	X	X	X	635
	7212B	ESD	X	X	X	X	X	X	X	X	634
	7213G	ESD	X	X	X	X	X	X	X	X	635
 EASY PLUS	7222PEK		X	X	X	X	X	X	X	X	633
	7223PEK		X	X	X	X	X	X	X	X	633
 BASIC	7241BK				X	X	X	X	X	X	630
	7243BK				X	X	X	X	X	X	630
	7246BK				X	X	X	X	X	X	632
	7247BK				X	X	X	X	X	X	632
 EASY	7246E				X	X	X	X	X	X	629
 TREKKING	7249GK	RS			X	X	X	X	X	X	638
 ACTIVE	7314AF		X	X	X	X	X	X	X	X	639
	7316NB	ESD	X	X	X	X	X	X	X	X	639
	7316NG	ESD	X	X	X	X	X	X	X	X	640
	7317NA		X	X	X	X	X	X	X	X	640
 0-GRAVITY	7352A	HRO	X	X	X	X	X	X	X	X	642
	7352B	HRO	X	X	X	X	X	X	X	X	642
	7352G	HRO ESD	X	X	X	X	X	X	X	X	642
	7353Y	HRO			X	X	X	X	X	X	643
	7372B	HRO	X	X	X	X	X	X	X	X	646
	7376A	HRO	X	X	X	X	X	X	X	X	646
 0-GRAVITY LADY	7352LG	HRO	X	X	X	X	X	X	X	X	643

EN ISO 20347:2012		O1 SRC									
 0-GRAVITY	7362B	FO HRO	X	X	X	X	X	X	X	X	645

EN ISO 20345:2022		S1PS SR									
 0-GRAVITY	7371V	HRO FO ESD	X	X	X	X	X	X	X	X	645

EN ISO 20347:2012		O2 SRC									
 BASIC	7243FT	FO			X	X				X	631
 0-GRAVITY	7363N	FO HRO	X	X	X	X					645

EN ISO 20345:2011		S3 SRC									
SERIE	ARTIKEL	VEREISTEN				AANBEVOLEN SECTOREN					📄
		AANVULLENDE VEREISTEN			AGRARISCH	AUTOMOTIVE	BOUW	INDUSTRIE	ELECTRICITEIT	TRANSPORT	
 FLEX	7214FN		X		X	X	X	X	X	X	635
	7214G	ESD	X		X	X	X	X	X	X	636
	7215FN		X		X	X	X	X	X	X	636
	7218FN	RS	X		X	X	X	X	X	X	636
	7218G	RS ESD	X		X	X	X	X	X	X	636
 EASY PLUS	7220PEK		X		X	X	X	X	X	X	633
	7221PEK	RS	X		X	X	X	X	X	X	633
 TREKKING	7236BK	RS			X	X	X				638
	7238WR	RS HRO WR			X	X	X				638
 EASY	7241EN				X	X	X		X		629
	7243EN	RS			X	X	X				629
 BASIC	7241CK				X	X	X	X		X	630
	7243CK	RS			X	X	X	X			631
	7243CR	RS HRO			X	X	X		X	X	631
	7245BK	RS			X	X	X	X			631
 HEAVY DUTY	7293HM	HRO HI	X		X	X				X	647
	7294HM	HRO HI	X		X	X				X	647
	7294HMC	HRO HI CI WR	X		X	X				X	647
 ACTIVE	7315AN		X		X	X	X	X	X	X	639
	7318AN		X		X	X	X	X	X	X	640
	7320NA		X		X	X	X	X	X	X	640
	7321NA	RS	X		X	X	X	X	X	X	641
	7322SA		X		X	X	X	X	X	X	641
	7323SA	RS	X		X	X	X	X	X	X	641
	7354N	HRO	X		X	X	X	X	X	X	643
 0-GRAVITY	7355V	HRO	X		X	X	X	X	X	X	643
	7356G	HRO	X		X	X	X	X	X	X	644
	7357G	HRO	X		X	X	X	X	X	X	644
	7356V	HRO	X		X	X	X	X	X	X	644
	7357V	HRO	X		X	X	X	X	X	X	645
	7356LN	HRO	X		X	X	X	X	X	X	644
 0-GRAVITY	7381N	HRO WR	X	X	X	X	X	X	X	X	646
	7382N	HRO WR	X	X	X	X	X	X	X	X	646

EN ISO 20345:2011		S5 SRC									
 BASIC	7328A				X	X	X			X	632
	7328N				X	X	X			X	632

EASY



7241EN

Leren schoen, waterafstotend.

- Stalen beschermneus
- Spijkerbestendige tussenzool uit composiet materiaal

**EN ISO
20345
2011**



EU	UK	mm	€		
35	2,5	230	45,00	1	072410835
36	3,5	237	45,00	1	072410836
37	4,5	244	45,00	1	072410837
38	5	250	45,00	1	072410838
39	6	257	45,00	1	072410839
40	6,5	264	45,00	1	072410840
41	7	270	45,00	1	072410841
42	8	277	45,00	1	072410842
43	9	284	45,00	1	072410843
44	10	290	45,00	1	072410844
45	10,5	297	45,00	1	072410845
46	11	304	45,00	1	072410846
47	12	310	45,00	1	072410847
48	13	317	45,00	1	072410848



CE

S3 SRC

7243EN

Leren enkelschoen, waterafstotend, met snelopening vetersysteem

- Stalen beschermneus
- Spijkerbestendige tussenzool uit composiet materiaal

**EN ISO
20345
2011**



EU	UK	mm	€		
35	2,5	230	47,00	1	072430835
36	3,5	237	47,00	1	072430836
37	4,5	244	47,00	1	072430837
38	5	250	47,00	1	072430838
39	6	257	47,00	1	072430839
40	6,5	264	47,00	1	072430840
41	7	270	47,00	1	072430841
42	8	277	47,00	1	072430842
43	9	284	47,00	1	072430843
44	10	290	47,00	1	072430844
45	10,5	297	47,00	1	072430845
46	11	304	47,00	1	072430846
47	12	310	47,00	1	072430847
48	13	317	47,00	1	072430848



CE

S3 RS SRC

7246E

Suede schoen, geperforeerd

- Stalen beschermneus
- Spijkerbestendige tussenzool uit composiet materiaal

**EN ISO
20345
2011**



EU	UK	mm	€		
35	2,5	230	49,00	1	072460435
36	3,5	237	49,00	1	072460436
37	4,5	244	49,00	1	072460437
38	5	250	49,00	1	072460438
39	6	257	49,00	1	072460439
40	6,5	264	49,00	1	072460440
41	7	270	49,00	1	072460441
42	8	277	49,00	1	072460442
43	9	284	49,00	1	072460443
44	10	290	49,00	1	072460444
45	10,5	297	49,00	1	072460445
46	11	304	49,00	1	072460446
47	12	310	49,00	1	072460447
48	13	317	49,00	1	072460448



CE

S1P SRC

BASIC



7241BK

Leren schoen.

- Stalen beschermneus
- Spijkerbestendige tussenzool uit composiet materiaal

**EN ISO
20345
2011**

EU	UK	mm	€		
35	2,5	228	54,00	1	072411235
36	3,5	235	54,00	1	072411236
37	4,5	242	54,00	1	072411237
38	5	248	54,00	1	072411238
39	6	255	54,00	1	072411239
40	6,5	262	54,00	1	072411240
41	7	268	54,00	1	072411241
42	8	275	54,00	1	072411242
43	9	282	54,00	1	072411243
44	10	288	54,00	1	072411244
45	10,5	295	54,00	1	072411245
46	11	302	54,00	1	072411246
47	12	308	54,00	1	072411247
48	13	315	54,00	1	072411248



CE

S1P SRC



7241CK

Leren schoen, waterafstotend.

- Stalen beschermneus
- Spijkerbestendige tussenzool uit composiet materiaal

**EN ISO
20345
2011**

EU	UK	mm	€		
35	2,5	228	57,00	1	072411535
36	3,5	235	57,00	1	072411536
37	4,5	242	57,00	1	072411537
38	5	248	57,00	1	072411538
39	6	255	57,00	1	072411539
40	6,5	262	57,00	1	072411540
41	7	268	57,00	1	072411541
42	8	275	57,00	1	072411542
43	9	282	57,00	1	072411543
44	10	288	57,00	1	072411544
45	10,5	295	57,00	1	072411545
46	11	302	57,00	1	072411546
47	12	308	57,00	1	072411547
48	13	315	57,00	1	072411548



CE

S3 SRC



7243BK

Leren enkelschoen, waterafstotend.

- Stalen beschermneus
- Spijkerbestendige tussenzool uit composiet materiaal

**EN ISO
20345
2011**

EU	UK	mm	€		
35	2,5	228	56,50	1	072431235
36	3,5	235	56,50	1	072431236
37	4,5	242	56,50	1	072431237
38	5	248	56,50	1	072431238
39	6	255	56,50	1	072431239
40	6,5	262	56,50	1	072431240
41	7	268	56,50	1	072431241
42	8	275	56,50	1	072431242
43	9	282	56,50	1	072431243
44	10	288	56,50	1	072431244
45	10,5	295	56,50	1	072431245
46	11	302	56,50	1	072431246
47	12	308	56,50	1	072431247
48	13	315	56,50	1	072431248



CE

S1P SRC



7243CK

Leren enkelschoen, waterafstotend, met snelopening vetersysteem

- Stalen beschermneus
- Spijkerbestendige tussenzool uit composiet materiaal

EU	UK	mm	€		
35	2,5	228	58,50	1	072431335
36	3,5	235	58,50	1	072431336
37	4,5	242	58,50	1	072431337
38	5	248	58,50	1	072431338
39	6	255	58,50	1	072431339
40	6,5	262	58,50	1	072431340
41	7	268	58,50	1	072431341
42	8	275	58,50	1	072431342
43	9	282	58,50	1	072431343
44	10	288	58,50	1	072431344
45	10,5	295	58,50	1	072431345
46	11	302	58,50	1	072431346
47	12	308	58,50	1	072431347
48	13	315	58,50	1	072431348

CE



S3 RS SRC

EN ISO 20345 2011



7243CR

Lederen enkelhoge schoen, waterafstotend, met een duurzame rubberen loopzool en snelopening systeem

- Stalen beschermneus
- Elastische stalen spijkerpenetratie bestendige tussenzool

EU	UK	mm	€		
35	2,5	231	86,50	1	072430735
36	3,5	238	86,50	1	072430736
37	4,5	245	86,50	1	072430737
38	5	251	86,50	1	072430738
39	6	258	86,50	1	072430739
40	6,5	265	86,50	1	072430740
41	7	271	86,50	1	072430741
42	8	278	86,50	1	072430742
43	9	285	86,50	1	072430743
44	10	291	86,50	1	072430744
45	10,5	298	86,50	1	072430745
46	11	305	86,50	1	072430746
47	12	311	86,50	1	072430747
48	13	318	86,50	1	072430748

CE



S3 RS HRO SRC

EN ISO 20345 2011



7243FT

Leren hoge schoen, waterafstotend, zonder beschermneus en spijkerbestendige inlegzool

- Zonder beschermneus
- Zonder spijkerpenetratie bestendige inlegzool

EU	UK	mm	€		
35	2,5	228	50,50	1	072430635
36	3,5	235	50,50	1	072430636
37	4,5	242	50,50	1	072430637
38	5	248	50,50	1	072430638
39	6	255	50,50	1	072430639
40	6,5	262	50,50	1	072430640
41	7	268	50,50	1	072430641
42	8	275	50,50	1	072430642
43	9	282	50,50	1	072430643
44	10	288	50,50	1	072430644
45	10,5	295	50,50	1	072430645
46	11	302	50,50	1	072430646
47	12	308	50,50	1	072430647
48	13	315	50,50	1	072430648

CE



O2 FO SRC

EN ISO 20347 2012



7245BK

Rijgveter leren enkelschoen, "lasser" stijl, waterafstotend, met snelopening vetersysteem en wreefbescherming met klittenbandsluiting

- Stalen beschermneus
- Spijkerbestendige tussenzool uit composiet materiaal

EU	UK	mm	€		
35	2,5	228	69,00	1	072451235
36	3,5	235	69,00	1	072451236
37	4,5	242	69,00	1	072451237
38	5	248	69,00	1	072451238
39	6	255	69,00	1	072451239
40	6,5	262	69,00	1	072451240
41	7	268	69,00	1	072451241
42	8	275	69,00	1	072451242
43	9	282	69,00	1	072451243
44	10	288	69,00	1	072451244
45	10,5	295	69,00	1	072451245
46	11	302	69,00	1	072451246
47	12	308	69,00	1	072451247
48	13	315	69,00	1	072451248

CE



S3 RS SRC

EN ISO 20345 2011



7246BK

Suede schoen, geperforeerd

- Stalen beschermneus
- Spijkerbestendige tussenzool uit composiet materiaal

EU	UK	mm	€		
35	2,5	228	60,00	1	072461235
36	3,5	235	60,00	1	072461236
37	4,5	242	60,00	1	072461237
38	5	248	60,00	1	072461238
39	6	255	60,00	1	072461239
40	6,5	262	60,00	1	072461240
41	7	268	60,00	1	072461241
42	8	275	60,00	1	072461242
43	9	282	60,00	1	072461243
44	10	288	60,00	1	072461244
45	10,5	295	60,00	1	072461245
46	11	302	60,00	1	072461246
47	12	308	60,00	1	072461247
48	13	315	60,00	1	072461248

CE



S1P SRC

EN ISO 20345 2011



7247BK

Leren sandaal, geperforeerd

- Stalen beschermneus
- Spijkerbestendige tussenzool uit composiet materiaal

EU	UK	mm	€		
35	2,5	228	59,50	1	072471235
36	3,5	235	59,50	1	072471236
37	4,5	242	59,50	1	072471237
38	5	248	59,50	1	072471238
39	6	255	59,50	1	072471239
40	6,5	262	59,50	1	072471240
41	7	268	59,50	1	072471241
42	8	275	59,50	1	072471242
43	9	282	59,50	1	072471243
44	10	288	59,50	1	072471244
45	10,5	295	59,50	1	072471245
46	11	302	59,50	1	072471246
47	12	308	59,50	1	072471247
48	13	315	59,50	1	072471248

CE



S1P SRC

EN ISO 20345 2011



7328A

"high-visibility" veiligheidslaars gemaakt van nitril-PVC. Met zelfreinigend antislip loopvlak.

- Stalen neus
- Elastische stalen penetratiebestendige binnenzool

EU	UK	mm	€		
38	5	253	46,00	1	073280638
39	6	260	46,00	1	073280639
40	6,5	267	46,00	1	073280640
41	7	273	46,00	1	073280641
42	8	280	46,00	1	073280642
43	9	287	46,00	1	073280643
44	10	293	46,00	1	073280644
45	10,5	300	46,00	1	073280645
46	11	307	46,00	1	073280646
47	12	313	46,00	1	073280647

CE



S5 SRC

EN ISO 20345 2011



7328N

veiligheidslaars gemaakt van nitril-PVC. Met zelfreinigend antislip loopvlak.

- Stalen neus
- Elastische stalen penetratiebestendige binnenzool

EU	UK	mm	€		
38	5	253	46,00	1	073280838
39	6	260	46,00	1	073280839
40	6,5	267	46,00	1	073280840
41	7	273	46,00	1	073280841
42	8	280	46,00	1	073280842
43	9	287	46,00	1	073280843
44	10	293	46,00	1	073280844
45	10,5	300	46,00	1	073280845
46	11	307	46,00	1	073280846
47	12	313	46,00	1	073280847

CE



S5 SRC

EN ISO 20345 2011



EASY PLUS



7220PEK

Leren schoen, waterafstotend, met nylon inzetstukken en schuurbestendige versteviging op het neusgedeelte

- Composiet beschermneus
- Spijkerbestendige tussenzool uit composiet materiaal

EU	UK	mm	€		
35	2,5	228	74,00	1	072200235
36	3,5	235	74,00	1	072200236
37	4,5	242	74,00	1	072200237
38	5	248	74,00	1	072200238
39	6	255	74,00	1	072200239
40	6,5	262	74,00	1	072200240
41	7	268	74,00	1	072200241
42	8	275	74,00	1	072200242
43	9	282	74,00	1	072200243
44	10	288	74,00	1	072200244
45	10,5	295	74,00	1	072200245
46	11	302	74,00	1	072200246
47	12	308	74,00	1	072200247
48	13	315	74,00	1	072200248

CE



S3 SRC

EN ISO 20345 2011

METAL FREE



7221PEK

Leren enkel schoen, waterafstotend, met nylon inzetstukken, schuurbestendige versteviging op het neusgedeelte en snelopening vetersysteem

- Composiet beschermneus
- Spijkerbestendige tussenzool uit composiet materiaal

EU	UK	mm	€		
35	2,5	228	78,50	1	072210235
36	3,5	235	78,50	1	072210236
37	4,5	242	78,50	1	072210237
38	5	248	78,50	1	072210238
39	6	255	78,50	1	072210239
40	6,5	262	78,50	1	072210240
41	7	268	78,50	1	072210241
42	8	275	78,50	1	072210242
43	9	282	78,50	1	072210243
44	10	288	78,50	1	072210244
45	10,5	295	78,50	1	072210245
46	11	302	78,50	1	072210246
47	12	308	78,50	1	072210247
48	13	315	78,50	1	072210248

CE



S3 RS SRC

EN ISO 20345 2011

METAL FREE



7222PEK

Suède schoen, geperforeerd, met zeer ademende mesh-inzetstukken

- Composiet beschermneus
- Spijkerbestendige tussenzool uit composiet materiaal

EU	UK	mm	€		
35	2,5	228	71,00	1	072220135
36	3,5	235	71,00	1	072220136
37	4,5	242	71,00	1	072220137
38	5	248	71,00	1	072220138
39	6	255	71,00	1	072220139
40	6,5	262	71,00	1	072220140
41	7	268	71,00	1	072220141
42	8	275	71,00	1	072220142
43	9	282	71,00	1	072220143
44	10	288	71,00	1	072220144
45	10,5	295	71,00	1	072220145
46	11	302	71,00	1	072220146
47	12	308	71,00	1	072220147
48	13	315	71,00	1	072220148

CE



S1P SRC

EN ISO 20345 2011

METAL FREE



7223PEK

Suede schoen met sterk ventilerende inzetstukken en schuurbestendige versteviging op het neusgedeelte

- Composit beschoermesneus
- Spijkerbestendige tussenzool uit composiet materiaal

EU	UK	mm	€		
35	2,5	228	78,00	1	072230135
36	3,5	235	78,00	1	072230136
37	4,5	242	78,00	1	072230137
38	5	248	78,00	1	072230138
39	6	255	78,00	1	072230139
40	6,5	262	78,00	1	072230140
41	7	268	78,00	1	072230141
42	8	275	78,00	1	072230142
43	9	282	78,00	1	072230143
44	10	288	78,00	1	072230144
45	10,5	295	78,00	1	072230145
46	11	302	78,00	1	072230146
47	12	308	78,00	1	072230147
48	13	315	78,00	1	072230148



CE

S1P SRC

EN ISO
20345
2011

METAL
FREE



FLEX

7212B

Suede schoen, geperforeerd, met mesh inzetstukken, Anti-slijtage inzetstuk bij veiligheidsneus Opmerkelijk flexibel en lichtgewicht - Geschatte gewicht voor maat 42: 490 g Niet aanbevolen voor gebruik bij zwaar werk (bouw, landbouw, zware industrie)

- Composit veiligheidsneus
- Compositvezel penetratie-proof binnenzool

EU	UK	mm	€		
35	2,5	228	86,50	1	072120235
36	3,5	235	86,50	1	072120236
37	4,5	242	86,50	1	072120237
38	5	248	86,50	1	072120238
39	6	255	86,50	1	072120239
40	6,5	262	86,50	1	072120240
41	7	268	86,50	1	072120241
42	8	275	86,50	1	072120242
43	9	282	86,50	1	072120243
44	10	288	86,50	1	072120244
45	10,5	295	86,50	1	072120245
46	11	302	86,50	1	072120246
47	12	308	86,50	1	072120247
48	13	315	86,50	1	072120248



CE

S1P SRC ESD

EN ISO
20345
2011



METAL
FREE



 **Beta**

7212G

suède schoen, geperforeerd. Met anti-slijtage inzetstuk in het gebied van de neus. Opmerkelijk flexibel en lichtgewicht - geschat gewicht voor maat 42: 490 g Niet aanbevolen voor zwaar werk (bouw, landbouw, zware industrie)

- Compositieus
- Compositivezel penetratiebestendige binnenzool

EU	UK	mm	€		
35	2.5	228	86,50	1	072120335
36	3.5	235	86,50	1	072120336
37	4.5	242	86,50	1	072120337
38	5	248	86,50	1	072120338
39	6	255	86,50	1	072120339
40	6.5	262	86,50	1	072120340
41	7	268	86,50	1	072120341
42	8	275	86,50	1	072120342
43	9	282	86,50	1	072120343
44	10	288	86,50	1	072120344
45	10.5	295	86,50	1	072120345
46	11	302	86,50	1	072120346
47	12	308	86,50	1	072120347
48	13	315	86,50	1	072120348

CE



S1P SRC ESD



EN ISO 20345 2011



7213G

Suède schoen, geperforeerd, met ademende mesh-inzetstukken. Opmerkelijk flexibel en lichtgewicht - Geschatte gewicht voor maat 42: 490 g Niet aanbevolen voor gebruik bij zwaar werk (gebouw, landbouw, zware industrie)

- Compositieiligheidsneus
- Compositivezel penetratie-proof binnenzool

EU	UK	mm	€		
35	2.5	228	86,50	1	072130135
36	3.5	235	86,50	1	072130136
37	4.5	242	86,50	1	072130137
38	5	248	86,50	1	072130138
39	6	255	86,50	1	072130139
40	6.5	262	86,50	1	072130140
41	7	268	86,50	1	072130141
42	8	275	86,50	1	072130142
43	9	282	86,50	1	072130143
44	10	288	86,50	1	072130144
45	10.5	295	86,50	1	072130145
46	11	302	86,50	1	072130146
47	12	308	86,50	1	072130147
48	13	315	86,50	1	072130148

CE



S1P SRC ESD



EN ISO 20345 2011



7214FN

Actieve nubuck schoen, waterafstootend, met schuurbestendig inzetstuk op het neusgedeelte. Extreem flexibel en lichtgewicht - geschatte gewicht maat 42: 500 g Niet aanbevolen voor intensief gebruik (bouw, agrarisch, zware industrie)

- Compositie beschermneus
- Spijkerbestendige tussenzool uit compositie materiaal

EU	UK	mm	€		
35	2.5	228	95,50	1	072140035
36	3.5	235	95,50	1	072140036
37	4.5	242	95,50	1	072140037
38	5	248	95,50	1	072140038
39	6	255	95,50	1	072140039
40	6.5	262	95,50	1	072140040
41	7	268	95,50	1	072140041
42	8	275	95,50	1	072140042
43	9	282	95,50	1	072140043
44	10	288	95,50	1	072140044
45	10.5	295	95,50	1	072140045
46	11	302	95,50	1	072140046
47	12	308	95,50	1	072140047
48	13	315	95,50	1	072140048

CE



S3 SRC



EN ISO 20345 2011



 **Beta**

7214G

NUBUCK Schoen, waterafstotend, met anti-slijtvaste inzetstukken bij de veiligheidsneus. Opmerkelijk flexibel en lichtgewicht - Geschatte gewicht voor maat 42: 500 g Niet aanbevolen voor gebruik bij zwaar werk (gebouw, landbouw, zware industrie)

EU	UK	mm	€		
35	2.5	228	93,50	1	072140235
36	3.5	235	93,50	1	072140236
37	4.5	242	93,50	1	072140237
38	5	248	93,50	1	072140238
39	6	255	93,50	1	072140239
40	6.5	262	93,50	1	072140240
41	7	268	93,50	1	072140241
42	8	275	93,50	1	072140242
43	9	282	93,50	1	072140243
44	10	288	93,50	1	072140244
45	10.5	295	93,50	1	072140245
46	11	302	93,50	1	072140246
47	12	308	93,50	1	072140247
48	13	315	93,50	1	072140248

- Composit veiligheidsneus
- Compositvezel penetratie-proof binnenzool



CE

S3 SRC ESD



EN ISO 20345 2011



7215FN

Actieve nubuck moccasin, waterafstotend, met schuurbestendig inzetstuk op het neusgedeelte. Extreem flexibel en lichtgewicht - geschatte gewicht, maat 42: 490 g Niet aanbevolen voor intensief gebruik (bouw, agrarisch, zware industrie)

EU	UK	mm	€		
35	2,5	228	98,00	1	072150135
36	3,5	235	98,00	1	072150136
37	4,5	242	98,00	1	072150137
38	5	248	98,00	1	072150138
39	6	255	98,00	1	072150139
40	6,5	262	98,00	1	072150140
41	7	268	98,00	1	072150141
42	8	275	98,00	1	072150142
43	9	282	98,00	1	072150143
44	10	288	98,00	1	072150144
45	10,5	295	98,00	1	072150145
46	11	302	98,00	1	072150146
47	12	308	98,00	1	072150147
48	13	315	98,00	1	072150148

- Composit beschermneus
- Spijkerbestendige tussenzool uit composit materiaal



CE

S3 SRC



EN ISO 20345 2011



7218FN

Actieve nubuck leren enkelschoen, waterafstotend, met schuur- bestendige inzetstuk en in het neusgedeelte een snelopening vetersysteem Extreem buigzaam en lichtgewicht - geschatte gewicht, maat 42: 510 g Niet aanbevolen voor intensief gebruik (bouw, agrarische of zware industrie)

EU	UK	mm	€		
35	2,5	228	98,00	1	072180035
36	3,5	235	98,00	1	072180036
37	4,5	242	98,00	1	072180037
38	5	248	98,00	1	072180038
39	6	255	98,00	1	072180039
40	6,5	262	98,00	1	072180040
41	7	268	98,00	1	072180041
42	8	275	98,00	1	072180042
43	9	282	98,00	1	072180043
44	10	288	98,00	1	072180044
45	10,5	295	98,00	1	072180045
46	11	302	98,00	1	072180046
47	12	308	98,00	1	072180047
48	13	315	98,00	1	072180048

- Composit beschermneus
- Spijkerbestendige tussenzool uit composit materiaal



CE

S3 RS SRC



EN ISO 20345 2011



7218G

NUBUCK enkelschoen, waterafstotend, met anti-slijtvaste inzetstukken bij de veiligheidsneus en snel openingssysteem. Opmerkelijk flexibel en lichtgewicht - Geschatte gewicht voor maat 42: 550 g Niet aanbevolen voor gebruik bij zwaar werk (bouw, landbouw, zware industrie)

EU	UK	mm	€		
35	2.5	228	98,00	1	072180135
36	3.5	235	98,00	1	072180136
37	4.5	242	98,00	1	072180137
38	5	248	98,00	1	072180138
39	6	255	98,00	1	072180139
40	6.5	262	98,00	1	072180140
41	7	268	98,00	1	072180141
42	8	275	98,00	1	072180142
43	9	282	98,00	1	072180143
44	10	288	98,00	1	072180144
45	10.5	295	98,00	1	072180145
46	11	302	98,00	1	072180146
47	12	308	98,00	1	072180147
48	13	315	98,00	1	072180148

- Composit veiligheidsneus
- Compositvezel penetratie-proof binnenzool



CE

S3 RS SRC ESD



EN ISO 20345 2011



BASIC PLUS



7201BKK

Volnerfleere enkelschoen, waterdicht

NIET TE KOOP

- composiet neus
- penetratiebestendige binnenzool van composiet

EU	UK	mm	
35	2,5	228	1 072010435
36	3,5	235	1 072010436
37	4,5	242	1 072010437
38	5	248	1 072010438
39	6	255	1 072010439
40	6,5	262	1 072010440
41	7	268	1 072010441
42	8	275	1 072010442
43	9	282	1 072010443
44	10	288	1 072010444
45	10,5	295	1 072010445
46	11	302	1 072010446
47	12	308	1 072010447
48	13	315	1 072010448



CE

S3 SRC

EN ISO 20345 2011

METAL FREE



7210BKK

zachte suède schoen, geperforeerd

NIET TE KOOP

- composiet neus
- penetratiebestendige binnenzool van composiet

EU	UK	mm	
35	2,5	228	1 072100335
36	3,5	235	1 072100336
37	4,5	242	1 072100337
38	5	248	1 072100338
39	6	255	1 072100339
40	6,5	262	1 072100340
41	7	268	1 072100341
42	8	275	1 072100342
43	9	282	1 072100343
44	10	288	1 072100344
45	10,5	295	1 072100345
46	11	302	1 072100346
47	12	308	1 072100347
48	13	315	1 072100348



CE

S1P SRC

EN ISO 20345 2011

METAL FREE



7216BKK

zachte suède sandaal, met riemsluiting

NIET TE KOOP

- composiet neus
- penetratiebestendige binnenzool van composiet

EU	UK	mm	
35	2,5	228	1 072160335
36	3,5	235	1 072160336
37	4,5	242	1 072160337
38	5	248	1 072160338
39	6	255	1 072160339
40	6,5	262	1 072160340
41	7	268	1 072160341
42	8	275	1 072160342
43	9	282	1 072160343
44	10	288	1 072160344
45	10,5	295	1 072160345
46	11	302	1 072160346
47	12	308	1 072160347
48	13	315	1 072160348



CE

S1P SRC

EN ISO 20345 2011

METAL FREE



TREKKING



7236BK

Actieve Nubuck enkel schoen, waterafstotend, met een polyurethaan versteviging op het neusgedeelte

- Stalen beschermneus
- Spijkerbestendige tussenzool uit composiet materiaal

EU	UK	mm	€		
35	2,5	228	86,00	1	072360335
36	3,5	235	86,00	1	072360336
37	4,5	242	86,00	1	072360337
38	5	248	86,00	1	072360338
39	6	255	86,00	1	072360339
40	6,5	262	86,00	1	072360340
41	7	268	86,00	1	072360341
42	8	275	86,00	1	072360342
43	9	282	86,00	1	072360343
44	10	288	86,00	1	072360344
45	10,5	295	86,00	1	072360345
46	11	302	86,00	1	072360346
47	12	308	86,00	1	072360347
48	13	315	86,00	1	072360348



CE

S3 RS SRC

EN ISO 20345 2011



7238WR

Suede enkelhoge schoen met nylon inzetstukken, duurzame rubber loopzool en snel open vetersysteem WR (water-afstotend) schoeisel: na 1,000 stappen in een tank met 3 cm water, het natte interne gedeelte moet zijn ≤ 3 cm² (spotmeting)

- Composiet beschermneus
- Spijkerbestendige tussenzool uit composiet materiaal

EU	UK	mm	€		
35	2,5	228	117,50	1	072380235
36	3,5	235	117,50	1	072380236
37	4,5	242	117,50	1	072380237
38	5	248	117,50	1	072380238
39	6	255	117,50	1	072380239
40	6,5	262	117,50	1	072380240
41	7	268	117,50	1	072380241
42	8	275	117,50	1	072380242
43	9	282	117,50	1	072380243
44	10	288	117,50	1	072380244
45	10,5	295	117,50	1	072380245
46	11	302	117,50	1	072380246
47	12	308	117,50	1	072380247
48	13	315	117,50	1	072380248



CE

S3 RS WR HRO SRC

EN ISO 20345 2011



7249GK

Suede hoge schoen met nylon inzetstukken en polyurethaan versteviging op het neusgedeelte

- Stalen beschermneus
- Spijkerbestendige tussenzool uit composiet materiaal

EU	UK	mm	€		
35	2,5	231	75,00	1	072490235
36	3,5	238	75,00	1	072490236
37	4,5	245	75,00	1	072490237
38	5	251	75,00	1	072490238
39	6	258	75,00	1	072490239
40	6,5	265	75,00	1	072490240
41	7	271	75,00	1	072490241
42	8	278	75,00	1	072490242
43	9	285	75,00	1	072490243
44	10	291	75,00	1	072490244
45	10,5	298	75,00	1	072490245
46	11	305	75,00	1	072490246
47	12	311	75,00	1	072490247
48	13	318	75,00	1	072490248



CE

S1P RS SRC

EN ISO 20345 2011



ACTIVE



7314AF

suede schoen
met nylon net en koolstof inzetstukken

- Composit beschermneus
- Spijkerbestendige tussenzool uit composiet

**EN ISO
20345
2011**

METAL
FREE



EU	UK	mm	€	W	L
35	2,5	228	115,50	1	073140235
36	3,5	235	115,50	1	073140236
37	4,5	242	115,50	1	073140237
38	5	248	115,50	1	073140238
39	6	255	115,50	1	073140239
40	6,5	262	115,50	1	073140240
41	7	268	115,50	1	073140241
42	8	275	115,50	1	073140242
43	9	282	115,50	1	073140243
44	10	288	115,50	1	073140244
45	10,5	295	115,50	1	073140245
46	11	302	115,50	1	073140246
47	12	308	115,50	1	073140247
48	13	315	115,50	1	073140248



CE

S1P SRC

7315AN

Suede en microfiber schoen,
waterafstotend, met koolstof inzetstukken

- Composit beschermneus
- Spijkerbestendige tussenzool uit composiet

**EN ISO
20345
2011**

METAL
FREE



EU	UK	mm	€	W	L
35	2,5	228	133,00	1	073150535
36	3,5	235	133,00	1	073150536
37	4,5	242	133,00	1	073150537
38	5	248	133,00	1	073150538
39	6	255	133,00	1	073150539
40	6,5	262	133,00	1	073150540
41	7	268	133,00	1	073150541
42	8	275	133,00	1	073150542
43	9	282	133,00	1	073150543
44	10	288	133,00	1	073150544
45	10,5	295	133,00	1	073150545
46	11	302	133,00	1	073150546
47	12	308	133,00	1	073150547
48	13	315	133,00	1	073150548



CE

S3 SRC

7316NB

schoen van mesh en suede, zeer ademend,
Hiel met stabiliteitsondersteuning

- Composit veiligheidsneus
- Compositvezel penetratie-proof binnenzool

**EN ISO
20345
2011**



METAL
FREE



EU	UK	mm	€	W	L
35	2,5	228	97,50	1	073160735
36	3,5	235	97,50	1	073160736
37	4,5	242	97,50	1	073160737
38	5	248	97,50	1	073160738
39	6	255	97,50	1	073160739
40	6,5	262	97,50	1	073160740
41	7	268	97,50	1	073160741
42	8	275	97,50	1	073160742
43	9	282	97,50	1	073160743
44	10	288	97,50	1	073160744
45	10,5	295	97,50	1	073160745
46	11	302	97,50	1	073160746
47	12	308	97,50	1	073160747
48	13	315	97,50	1	073160748



CE

S1P SRC ESD

7316NG

schoen van mesh en suede, zeer ademend,
Hiel met stabiliteitsondersteuning

- Compositief veiligheidsneus
- Compositiefvezel penetratie-proof binnenzool

EU	UK	mm	€		
35	2.5	228	97,50	1	073160635
36	3.5	235	97,50	1	073160636
37	4.5	242	97,50	1	073160637
38	5	248	97,50	1	073160638
39	6	255	97,50	1	073160639
40	6.5	262	97,50	1	073160640
41	7	268	97,50	1	073160641
42	8	275	97,50	1	073160642
43	9	282	97,50	1	073160643
44	10	288	97,50	1	073160644
45	10.5	295	97,50	1	073160645
46	11	302	97,50	1	073160646
47	12	308	97,50	1	073160647
48	13	315	97,50	1	073160648

CE



S1P SRC ESD



7317NA

Suede schoen, geperforeerd,
met microfiber versteviging inzetstukken in het hielgedeelte

- Compositief beschermneus
- Spijkerbestendige tussenzool uit compositief materiaal

EU	UK	mm	€		
35	2.5	228	83,50	1	073170135
36	3.5	235	83,50	1	073170136
37	4.5	242	83,50	1	073170137
38	5	248	83,50	1	073170138
39	6	255	83,50	1	073170139
40	6.5	262	83,50	1	073170140
41	7	268	83,50	1	073170141
42	8	275	83,50	1	073170142
43	9	282	83,50	1	073170143
44	10	288	83,50	1	073170144
45	10.5	295	83,50	1	073170145
46	11	302	83,50	1	073170146
47	12	308	83,50	1	073170147
48	13	315	83,50	1	073170148

CE



S1P SRC



7318AN

Suede enkelschoen met microfiber,
waterafstotend, met carbon inzetstukken

- Compositief beschermneus
- Spijkerbestendige tussenzool uit compositief materiaal

EU	UK	mm	€		
35	2.5	228	137,50	1	073180535
36	3.5	235	137,50	1	073180536
37	4.5	242	137,50	1	073180537
38	5	248	137,50	1	073180538
39	6	255	137,50	1	073180539
40	6.5	262	137,50	1	073180540
41	7	268	137,50	1	073180541
42	8	275	137,50	1	073180542
43	9	282	137,50	1	073180543
44	10	288	137,50	1	073180544
45	10.5	295	137,50	1	073180545
46	11	302	137,50	1	073180546
47	12	308	137,50	1	073180547
48	13	315	137,50	1	073180548

CE



S3 SRC



7320NA

Nubuck schoen, waterafstotend,
met schuurbestendig versteviging in het neusgedeelte

- Compositief beschermneus
- Spijkerbestendige tussenzool uit compositief materiaal

EU	UK	mm	€		
35	2.5	228	88,00	1	073200435
36	3.5	235	88,00	1	073200436
37	4.5	242	88,00	1	073200437
38	5	248	88,00	1	073200438
39	6	255	88,00	1	073200439
40	6.5	262	88,00	1	073200440
41	7	268	88,00	1	073200441
42	8	275	88,00	1	073200442
43	9	282	88,00	1	073200443
44	10	288	88,00	1	073200444
45	10.5	295	88,00	1	073200445
46	11	302	88,00	1	073200446
47	12	308	88,00	1	073200447
48	13	315	88,00	1	073200448

CE



S3 SRC



7321NA

Nubuck schoen, waterafstotend, met snel opening vetersysteem en schuurbestendig versteviging in het neusgedeelte

- Composit beschermneus
- Spijkerbestendige tussenzool uit composit materiaal

EU	UK	mm	€		
35	2,5	228	90,50	1	073210435
36	3,5	235	90,50	1	073210436
37	4,5	242	90,50	1	073210437
38	5	248	90,50	1	073210438
39	6	255	90,50	1	073210439
40	6,5	262	90,50	1	073210440
41	7	268	90,50	1	073210441
42	8	275	90,50	1	073210442
43	9	282	90,50	1	073210443
44	10	288	90,50	1	073210444
45	10,5	295	90,50	1	073210445
46	11	302	90,50	1	073210446
47	12	308	90,50	1	073210447
48	13	315	90,50	1	073210448



CE

S3 RS SRC



EN ISO 20345 2011



7322SA

Stoffen schoen, zeer slijtvast, met hielstabiliteits ondersteuning

- Composit beschermneus
- Spijkerbestendige tussenzool uit composit materiaal

EU	UK	mm	€		
35	2,5	228	94,00	1	073220435
36	3,5	235	94,00	1	073220436
37	4,5	242	94,00	1	073220437
38	5	248	94,00	1	073220438
39	6	255	94,00	1	073220439
40	6,5	262	94,00	1	073220440
41	7	268	94,00	1	073220441
42	8	275	94,00	1	073220442
43	9	282	94,00	1	073220443
44	10	288	94,00	1	073220444
45	10,5	295	94,00	1	073220445
46	11	302	94,00	1	073220446
47	12	308	94,00	1	073220447
48	13	315	94,00	1	073220448



CE

S3 SRC



EN ISO 20345 2011



7323SA

Stoffen enkelhoge schoen, zeer slijtvast, met snel extractie systeem en hielstabiliteits ondersteuning

- Composit beschermneus
- Spijkerbestendige tussenzool uit composit materiaal

EU	UK	mm	€		
35	2,5	228	96,00	1	073230435
36	3,5	235	96,00	1	073230436
37	4,5	242	96,00	1	073230437
38	5	248	96,00	1	073230438
39	6	255	96,00	1	073230439
40	6,5	262	96,00	1	073230440
41	7	268	96,00	1	073230441
42	8	275	96,00	1	073230442
43	9	282	96,00	1	073230443
44	10	288	96,00	1	073230444
45	10,5	295	96,00	1	073230445
46	11	302	96,00	1	073230446
47	12	308	96,00	1	073230447
48	13	315	96,00	1	073230448



CE

S3 RS SRC



EN ISO 20345 2011



Beta

O-GRAVITY



7352A

Net weefsel schoen, sterk ventilerend, met TPU inzetstukken
Hiel stabiliteit ondersteuning, stretch instapkraag
en EVA loopzool van duurzaam nitril geprofileerd rubber

- Beschermneus uit composiet materiaal
- Spijkerbestendige tussenzool uit composiet materiaal
- OPMERKELIJK LICHT: geschatte gewicht, maat 42: 450 g

EN ISO
20345
2011

EU	UK	mm	€		
38	5	254	140,50	1	073520038
39	6	261	140,50	1	073520039
40	6,5	268	140,50	1	073520040
41	7	274	140,50	1	073520041
42	8	281	140,50	1	073520042
43	9	288	140,50	1	073520043
44	10	294	140,50	1	073520044
45	10,5	301	140,50	1	073520045
46	11	308	140,50	1	073520046
47	12	314	140,50	1	073520047
48	13	321	140,50	1	073520048



METAL
FREE



CE

S1P HRO SRC

7352B

Net weefsel schoen, sterk ventilerend, met TPU inzetstukken
Hiel stabiliteit ondersteuning, stretch instapkraag
en EVA loopzool van duurzaam geprofileerd nitril rubber

- Beschermneus uit composiet materiaal
- Spijkerbestendige tussenzool uit composiet materiaal
- OPMERKELIJK LICHT: geschatte gewicht, maat 42: 450 g

EN ISO
20345
2011

EU	UK	mm	€		
38	5	254	140,50	1	073520138
39	6	261	140,50	1	073520139
40	6,5	268	140,50	1	073520140
41	7	274	140,50	1	073520141
42	8	281	140,50	1	073520142
43	9	288	140,50	1	073520143
44	10	294	140,50	1	073520144
45	10,5	301	140,50	1	073520145
46	11	308	140,50	1	073520146
47	12	314	140,50	1	073520147
48	13	321	140,50	1	073520148



METAL
FREE



CE

S1P HRO SRC

7352G

schoen van mesh, zeer ademend, met TPU-inzetstukken"
Hielstabiliteit, traditionele vetersluiting, brede pasvorm.
EVA-loopzool met duurzaam nitrilrubber loopvlak

- Composiet neus
- Composietvezel penetratiebestendige binnenzool
- OPMERKELIJK LICHTGEWICHT: geschat gewicht voor maat 42: 450 gram

EN ISO
20345
2011

EU	UK	mm	€		
38	5	254	147,50	1	073520338
39	6	261	147,50	1	073520339
40	6,5	268	147,50	1	073520340
41	7	274	147,50	1	073520341
42	8	281	147,50	1	073520342
43	9	288	147,50	1	073520343
44	10	294	147,50	1	073520344
45	10,5	301	147,50	1	073520345
46	11	308	147,50	1	073520346
47	12	314	147,50	1	073520347
48	13	321	147,50	1	073520348



METAL
FREE



CE

S1P HRO SRC ESD

7352LG

Damesschoen van meshstof, zeer goed ademend, met TPU-inzetstukken

Reflecterend mesh bovenwerk met hoge zichtbaarheid
Hielstabiliteitsondersteuning, elastische instapkraag en EVA-loopzool met duurzaam nitrilrubber loopvlak

- Veiligheidsneus uit glasfiber
- Spijkerbestendige tussenzool uit composiet materiaal
- **OPMERKELIJK LICHTGEWICHT:** gewicht bij benadering voor maat 38: 390 grams

EN ISO 20345 2011

METAL FREE



CE

S1P HRO SRC

EU	UK	mm	€		
34	2	228	146,00	1	073520234
35	2,5	234	146,00	1	073520235
36	3,5	241	146,00	1	073520236
37	4,5	248	146,00	1	073520237
38	5	254	146,00	1	073520238
39	6	261	146,00	1	073520239
40	6,5	268	146,00	1	073520240
41	7	274	146,00	1	073520241
42	8	281	146,00	1	073520242

7353Y

Net weefsel schoen, sterk ventilerend, met TPU inzetstukken

Hoge zichtbaarheid net afwerking bovenkant
Hiel stabiliteit ondersteuning, stretch instapkraag en EVA loopzool van duurzaam geprofileerd nitril rubber

- Koolstof vezel beschermneus
- Spijkerbestendige tussenzool uit composiet materiaal
- **OPMERKELIJK LICHT:** geschatte gewicht, maat 42: 420 g

EN ISO 20345 2011

METAL FREE



CE

S1P HRO SRC

EU	UK	mm	€		
38	5	254	186,00	1	073530038
39	6	261	186,00	1	073530039
40	6,5	268	186,00	1	073530040
41	7	274	186,00	1	073530041
42	8	281	186,00	1	073530042
43	9	288	186,00	1	073530043
44	10	294	186,00	1	073530044
45	10,5	301	186,00	1	073530045
46	11	308	186,00	1	073530046
47	12	314	186,00	1	073530047
48	13	321	186,00	1	073530048

7354N

Net weefsel schoen, waterafstotend, met TPU inzetstukken

Hiel stabiliteit ondersteuning, stretch instapkraag en EVA loopzool van duurzaam geprofileerd nitril rubber

- Beschermneus uit composiet materiaal
- Spijkerbestendige tussenzool uit composiet materiaal
- **OPMERKELIJK LICHT:** geschatte gewicht maat 42: 460 g

EN ISO 20345 2011

METAL FREE



CE

S3 HRO SRC

EU	UK	mm	€		
38	5	254	146,00	1	073540038
39	6	261	146,00	1	073540039
40	6,5	268	146,00	1	073540040
41	7	274	146,00	1	073540041
42	8	281	146,00	1	073540042
43	9	288	146,00	1	073540043
44	10	294	146,00	1	073540044
45	10,5	301	146,00	1	073540045
46	11	308	146,00	1	073540046
47	12	314	146,00	1	073540047
48	13	321	146,00	1	073540048

7355V

Net weefsel schoen, waterafstotend, met TPU inzetstukken

Hiel stabiliteit ondersteuning, stretch instapkraag en EVA loopzool van duurzaam geprofileerd nitril rubber

- Beschermneus uit composiet materiaal
- Spijkerbestendige tussenzool uit composiet materiaal
- **OPMERKELIJK LICHT:** geschatte gewicht maat 42: 465 g

EN ISO 20345 2011

METAL FREE



CE

S3 HRO SRC

EU	UK	mm	€		
38	5	254	156,00	1	073550038
39	6	261	156,00	1	073550039
40	6,5	268	156,00	1	073550040
41	7	274	156,00	1	073550041
42	8	281	156,00	1	073550042
43	9	288	156,00	1	073550043
44	10	294	156,00	1	073550044
45	10,5	301	156,00	1	073550045
46	11	308	156,00	1	073550046
47	12	314	156,00	1	073550047
48	13	321	156,00	1	073550048

7356G

Microfiber schoen, water afstotend, met TPU inzetstukken
Hielstabiliteits ondersteuning, elastische instapkraag
en EVA tussenzool en loopzool van duurzaam nitril rubber

- Composiet beschermneus
- Spijkerbestendige tussenzool uit composiet materiaal
- OPMERKELIJK LICHTGEWICHT: gewicht bij benadering voor maat 42: 460 gram

**EN ISO
20345
2011**

EU	UK	mm	€		
38	5	254	150,50	1	073560038
39	6	261	150,50	1	073560039
40	6,5	268	150,50	1	073560040
41	7	274	150,50	1	073560041
42	8	281	150,50	1	073560042
43	9	288	150,50	1	073560043
44	10	294	150,50	1	073560044
45	10,5	301	150,50	1	073560045
46	11	308	150,50	1	073560046
47	12	314	150,50	1	073560047
48	13	321	150,50	1	073560048



**METAL
FREE**



CE

S3 HRO SRC

7356V

Schoen van microfiber, waterafstotend, met TPU inzetstukken
Hielstabiliteits ondersteuning, elastische instapkraag
en EVA loopzool van duurzaam geprofileerd nitril rubber

- Beschermneus uit composiet materiaal
- Spijkerbestendige tussenzool uit composiet materiaal
- OPMERKELIJK LICHTGEWICHT: gewicht bij benadering voor maat 42: 460 grams

**EN ISO
20345
2011**

EU	UK	mm	€		
38	5	254	150,50	1	073560138
39	6	261	150,50	1	073560139
40	6,5	268	150,50	1	073560140
41	7	274	150,50	1	073560141
42	8	281	150,50	1	073560142
43	9	288	150,50	1	073560143
44	10	294	150,50	1	073560144
45	10,5	301	150,50	1	073560145
46	11	308	150,50	1	073560146
47	12	314	150,50	1	073560147
48	13	321	150,50	1	073560148



**METAL
FREE**



CE

S3 HRO SRC

7356LN

Damesschoen van microfiber, waterafstotend, met TPU
inzetstukken
Hielstabiliteits ondersteuning, elastische instapkraag
en EVA loopzool van duurzaam geprofileerd nitril rubber

- Veiligheidsneus uit glasfiber
- Spijkerbestendige tussenzool uit composiet materiaal
- OPMERKELIJK LICHTGEWICHT: gewicht bij benadering voor maat 38: 390 grams

**EN ISO
20345
2011**

EU	UK	mm	€		
34	2	228	149,50	1	073560234
35	2,5	234	149,50	1	073560235
36	3,5	241	149,50	1	073560236
37	4,5	248	149,50	1	073560237
38	5	254	149,50	1	073560238
39	6	261	149,50	1	073560239
40	6,5	268	149,50	1	073560240
41	7	274	149,50	1	073560241
42	8	281	149,50	1	073560242



lady



**METAL
FREE**



CE

S3 HRO SRC

7357G

Microfiber enkelhoge schoen, water afstotend, met TPU
inzetstukken
Hielstabiliteits ondersteuning, elastische instapkraag
en EVA tussenzool en loopzool van duurzaam nitril rubber

- Composiet beschermneus
- Spijkerbestendige tussenzool uit composiet materiaal
- OPMERKELIJK LICHTGEWICHT: gewicht bij benadering voor maat 42: 480 gram

**EN ISO
20345
2011**

EU	UK	mm	€		
38	5	254	167,50	1	073570038
39	6	261	167,50	1	073570039
40	6,5	268	167,50	1	073570040
41	7	274	167,50	1	073570041
42	8	281	167,50	1	073570042
43	9	288	167,50	1	073570043
44	10	294	167,50	1	073570044
45	10,5	301	167,50	1	073570045
46	11	308	167,50	1	073570046
47	12	314	167,50	1	073570047
48	13	321	167,50	1	073570048



**METAL
FREE**



CE

S3 HRO SRC

7357V

Enkelhoge schoen van microfiber, waterafstotend met TPU inzetstukken

Hielstabiliteits ondersteuning, elastische instapkraag en EVA loopzool van duurzaam geprofileerd nitril rubber

- Beschermneus uit composiet materiaal
- Spijkerbestendige tussenzool uit composiet materiaal
- **OPMERKELIJK LICHTGEWICHT:** gewicht bij benadering voor maat 42: 480 grams

EN ISO 20345 2011



METAL FREE



EU	UK	mm	€		
38	5	254	167,50	1	073570138
39	6	261	167,50	1	073570139
40	6,5	268	167,50	1	073570140
41	7	274	167,50	1	073570141
42	8	281	167,50	1	073570142
43	9	288	167,50	1	073570143
44	10	294	167,50	1	073570144
45	10,5	301	167,50	1	073570145
46	11	308	167,50	1	073570146
47	12	314	167,50	1	073570147
48	13	321	167,50	1	073570148

CE



S3 HRO SRC

7362B

Werkschoen, vervaardigd uit mesh materiaal, zeer ademend, met TPU inzetstukken

Hielstabiliteit ondersteuning, elastische instapkraag en EVA tussenzool en loopzool van duurzaam nitril rubber

- Zonder veiligheidsneus
- Zonder penetratiebestendige binnenzool
- **OPMERKELIJK LICHTGEWICHT:** gewicht bij benadering voor maat 42: 330 grams

EN ISO 20347 2012



METAL FREE



EU	UK	mm	€		
39	6	261	127,50	1	073620039
40	6,5	268	127,50	1	073620040
41	7	274	127,50	1	073620041
42	8	281	127,50	1	073620042
43	9	288	127,50	1	073620043
44	10	294	127,50	1	073620044
45	10,5	301	127,50	1	073620045
46	11	308	127,50	1	073620046
47	12	314	127,50	1	073620047
48	13	321	127,50	1	073620048

CE



O1 FO HRO SRC

7363N

Werkschoen, vervaardigd uit mesh materiaal, waterafstotend, met TPU inzetstukken

Hielstabiliteit ondersteuning, elastische instapkraag en EVA tussenzool en loopzool van duurzaam nitril rubber

- Zonder veiligheidsneus
- Zonder penetratiebestendige binnenzool
- **OPMERKELIJK LICHTGEWICHT:** gewicht bij benadering voor maat 42: 330 grams

EN ISO 20347 2012



METAL FREE



EU	UK	mm	€		
39	6	261	133,50	1	073630039
40	6,5	268	133,50	1	073630040
41	7	274	133,50	1	073630041
42	8	281	133,50	1	073630042
43	9	288	133,50	1	073630043
44	10	294	133,50	1	073630044
45	10,5	301	133,50	1	073630045
46	11	308	133,50	1	073630046
47	12	314	133,50	1	073630047
48	13	321	133,50	1	073630048

CE



O2 FO HRO SRC

7371V

Mesh schoen, ultra ademend. Hielstabiliteitsondersteuning, traditonele vetersluiting, brede pasvorm. EVA-loopzool met duurzaam loopvlak van nitrilrubber

- Beschermneus uit composiet materiaal
- Spijkerbestendige tussenzool uit composiet materiaal
- **OPMERKELIJK LICHT:** geschatte gewicht, maat 42: 450 g

EN ISO 20345 2022



METAL FREE



EU	UK	mm	€		
38	5	254	147,50	1	073710038
39	6	261	147,50	1	073710039
40	6,5	268	147,50	1	073710040
41	7	274	147,50	1	073710041
42	8	281	147,50	1	073710042
43	9	288	147,50	1	073710043
44	10	294	147,50	1	073710044
45	10,5	301	147,50	1	073710045
46	11	308	147,50	1	073710046
47	12	314	147,50	1	073710047
48	13	321	147,50	1	073710048

CE



S1PS HRO FO SR ESD

7372B

Stoffenschoen, slijtvast en ultra licht.

Hiel met stabiliteitsondersteuning, traditionele veters, brede pasvorm.

Eva-tussenzool met duurzaam nitril-rubberen loopvlak.

- Composiet veiligheidsneus
- Composietvezel penetratie-proof binnenzool
- Opmerkelijk lichtgewicht: geschat gewicht voor maat 42: 450 g

EN ISO 20345 2011

EU	UK	mm	€		
38	5	254	149,50	1	073720038
39	6	261	149,50	1	073720039
40	6.5	268	149,50	1	073720040
41	7	274	149,50	1	073720041
42	8	281	149,50	1	073720042
43	9	288	149,50	1	073720043
44	10	294	149,50	1	073720044
45	10.5	301	149,50	1	073720045
46	11	308	149,50	1	073720046
47	12	314	149,50	1	073720047
48	13	321	149,50	1	073720048

CE



S1P HRO SRC



7376A

Microvezel en mesh sandaal, geperforeerd en zeer ademend

Hiel met stabiliteitsondersteuning, traditionele veters, brede pasvorm.

Eva-tussenzool met duurzaam nitril-rubberen loopvlak.

- Composiet veiligheidsneus
- Composietvezel penetratie-proof binnenzool
- Opmerkelijk lichtgewicht: gewicht voor maat 42: 490 g

EN ISO 20345 2011

EU	UK	mm	€		
38	5	254	152,00	1	073760038
39	6	261	152,00	1	073760039
40	6.5	268	152,00	1	073760040
41	7	274	152,00	1	073760041
42	8	281	152,00	1	073760042
43	9	288	152,00	1	073760043
44	10	294	152,00	1	073760044
45	10.5	301	152,00	1	073760045
46	11	308	152,00	1	073760046
47	12	314	152,00	1	073760047
48	13	321	152,00	1	073760048

CE



S1P HRO SRC



7381N

waterdichte schoen gemaakt van zeer slijtvaste stof, met TPU-inzetstukken. Hielstabiliteit, traditionele vetersluiting, brede pasvorm. EVA-loopzool met duurzaam nitrilrubber loopvlak.

- Composiet neus
- Composietvezel penetratiebestendige binnenzool
- Beta TECH waterdichtingsmembraan, met bootie-systeem
- LICHTGEWICHT: geschat gewicht voor maat 42: 500 g

EN ISO 20345 2011

EU	UK	mm	€		
38	5	254	174,00	1	073810038
39	6	261	174,00	1	073810039
40	6.5	268	174,00	1	073810040
41	7	274	174,00	1	073810041
42	8	281	174,00	1	073810042
43	9	288	174,00	1	073810043
44	10	294	174,00	1	073810044
45	10.5	301	174,00	1	073810045
46	11	308	174,00	1	073810046
47	12	314	174,00	1	073810047
48	13	321	174,00	1	073810048

CE



S3 SRC HRO WR



7382N

waterdichte enkelschoen, gemaakt van zeer slijtvaste stof, met TPU-inzetstukken. Hielstabiliteit, traditionele vetersluiting, brede pasvorm. EVA-loopzool met duurzaam nitrilrubber loopvlak.

- Composiet neus
- Composietvezel penetratiebestendige binnenzool
- Beta TECH waterdichtingsmembraan, met bootie-systeem
- LICHTGEWICHT: geschat gewicht voor maat 42: 550 g

EN ISO 20345 2011

EU	UK	mm	€		
38	5	254	195,00	1	073820038
39	6	261	195,00	1	073820039
40	6.5	268	195,00	1	073820040
41	7	274	195,00	1	073820041
42	8	281	195,00	1	073820042
43	9	288	195,00	1	073820043
44	10	294	195,00	1	073820044
45	10.5	301	195,00	1	073820045
46	11	308	195,00	1	073820046
47	12	314	195,00	1	073820047
48	13	321	195,00	1	073820048

CE



S3 SRC HRO WR



HEAVY DUTY



7293HM

Gevette volnerf schoen, waterafstotend, met duurzame VIBRAM® rubber loopzool, schuurbestendig inzetstuk in het hiel gedeelte en versterkte polyurethaan neusbescherming

- Veiligheidsneus uit glasfiber
- Spijkerbestendige tussenzool uit composiet materiaal

EN ISO 20345 2011



EU	UK	mm	€		
39	6	263	204,00	1	072930639
40	6,5	270	204,00	1	072930640
41	7	276	204,00	1	072930641
42	8	283	204,00	1	072930642
43	9	289	204,00	1	072930643
44	10	296	204,00	1	072930644
45	10,5	302	204,00	1	072930645
46	11	309	204,00	1	072930646
47	12	315	204,00	1	072930647
48	13	322	204,00	1	072930648



CE

S3 HRO HI SRC

7294HM

Gevette volnerf enkelschoen, waterafstotend, met duurzame VIBRAM® rubber loopzool, schuurbestendig inzetstuk in het hiel gedeelte en versterkte polyurethaan neusbescherming

- Veiligheidsneus uit glasfiber
- Spijkerbestendige tussenzool uit composiet materiaal

EN ISO 20345 2011



EU	UK	mm	€		
39	6	263	214,50	1	072940639
40	6,5	270	214,50	1	072940640
41	7	276	214,50	1	072940641
42	8	283	214,50	1	072940642
43	9	289	214,50	1	072940643
44	10	296	214,50	1	072940644
45	10,5	302	214,50	1	072940645
46	11	309	214,50	1	072940646
47	12	315	214,50	1	072940647
48	13	322	214,50	1	072940648



CE

S3 HRO HI SRC

7294HMC

Gevette volnerf leren enkelschoen, waterafstotend, met duurzame VIBRAM® rubber loopzool, schuurbestendige inzetstuk in het hielgedeelte en versterkte polyurethaan neusbescherming. Met een Tepor membraan, waterproof, winddicht, sterk ventilerend

- Veiligheidsneus uit glasfiber
- Spijkerbestendige tussenzool uit composiet materiaal

EN ISO 20345 2011



EU	UK	mm	€		
39	6	263	241,00	1	072940739
40	6,5	270	241,00	1	072940740
41	7	276	241,00	1	072940741
42	8	283	241,00	1	072940742
43	9	289	241,00	1	072940743
44	10	296	241,00	1	072940744
45	10,5	302	241,00	1	072940745
46	11	309	241,00	1	072940746
47	12	315	241,00	1	072940747
48	13	322	241,00	1	072940748



CE

S3 HRO HI CI WR SRC

ACCESSORIES

7398 0/G

Anatomisch gevormde inlegzolen vervaardigd uit EVA foam, met dempend kussen in het hielgedeelte (dit artikel is aanbevolen voor de serie 0-Gravity schoenen)



EU	UK	€		
38	5	8,90	1	073981238
39	6	8,90	1	073981239
40	6,5	8,90	1	073981240
41	7	8,90	1	073981241
42	8	8,90	1	073981242
43	9	8,90	1	073981243
44	10	8,90	1	073981244
45	10,5	8,90	1	073981245
46	11	8,90	1	073981246
47	12	8,90	1	073981247
48	13	8,90	1	073981248

7398ESD

anatomisch gevormde, ademende ondervoetbedekking, antibacteriële toplaag die slechte geurtjes voorkomt. Vervanging voor ESD (ElectroStatic Discharge) gecertificeerde schoenen



EU	UK	€		
35	2,5	9,25	1	073981435
36	3,5	9,25	1	073981436
37	4,5	9,25	1	073981437
38	5	9,25	1	073981438
39	6	9,25	1	073981439
40	6,5	9,25	1	073981440
41	7	9,25	1	073981441
42	8	9,25	1	073981442
43	9	9,25	1	073981443
44	10	9,25	1	073981444
45	10,5	9,25	1	073981445
46	11	9,25	1	073981446
47	12	9,25	1	073981447
48	13	9,25	1	073981448

7398T

Anatomisch gevormde inlegzolen met WINTHERM insulatie. 70 % gealuminiseerd polyester, 30% polyethyleen, gebonden aan niet-geweven synthetische vezels. Antistatisch, ademend, snel absorberend, geurwerend, antibacterieel, schimmeldodend.



WINDTHERM

EU	UK	€		
35	2,5	17,10	1	073981335
36	3,5	17,10	1	073981336
37	4,5	17,10	1	073981337
38	5	17,10	1	073981338
39	6	17,10	1	073981339
40	6,5	17,10	1	073981340
41	7	17,10	1	073981341
42	8	17,10	1	073981342
43	9	17,10	1	073981343
44	10	17,10	1	073981344
45	10,5	17,10	1	073981345
46	11	17,10	1	073981346
47	12	17,10	1	073981347
48	13	17,10	1	073981348

7398U

Anatomisch gevormde inlegzolen vervaardigd uit TPR GEL met een hoog dempend effect, planitaire voetboog ondersteuning en hielkussen.



EU	UK	€		
36 - 40	3,5 - 6,5	17,30	1	073980058
41 - 46	7 - 11	17,30	1	073980063

Beta

7398UP

Anatomisch gevormde inlegzool vervaardigd uit een naar citrus ruikende TPE GEL, met voetboog ondersteuning



EU	UK	€		
36 - 40	3,5 - 6	14,40	1	073980076
41 - 46	7 - 11	14,40	1	073980081

7398GEL

Anatomisch gevormde gel inlegzolen



EU	UK	€		
35	2,5	5,30	1	073980835
36	3,5	5,30	1	073980836
37	4,5	5,30	1	073980837
38	5	5,30	1	073980838
39	6	5,30	1	073980839
40	6,5	5,30	1	073980840
41	7	5,30	1	073980841
42	8	5,30	1	073980842
43	9	5,30	1	073980843
44	10	5,30	1	073980844
45	10,5	5,30	1	073980845
46	11	5,30	1	073980846
47	12	5,30	1	073980847
48	13	5,30	1	073980848

7398EF

Anatomisch gevormde inlegzool vervaardigd uit polyurethaan foam, met schokdemping in de hiel



EU	UK	€		
35	2,5	9,90	1	073981135
36	3,5	9,90	1	073981136
37	4,5	9,90	1	073981137
38	5	9,90	1	073981138
39	6	9,90	1	073981139
40	6,5	9,90	1	073981140
41	7	9,90	1	073981141
42	8	9,90	1	073981142
43	9	9,90	1	073981143
44	10	9,90	1	073981144
45	10,5	9,90	1	073981145
46	11	9,90	1	073981146
47	12	9,90	1	073981147
48	13	9,90	1	073981148

7399 A/N...

Pak van 10 paar veters, 110 - 120 cm



cm	€		
100	18,00	1	073990010
120	20,50	1	073990012
140	25,00	1	073990017

Prijzen op basis van 10 paar

7421

Knie hoge sokken vervaardigd uit een elastisch drukverhogende materiaal Terry, met nylon en katoenen versteviging in hiel en teen gedeelte.

Loopvlak vervaardigd uit slijtvaste, schimmelwerende, ventilerende bamboo vezels.



	EU	€		
M	39-42	19,30	1	074210002
L	43-46	19,30	1	074210004

7422P

Kuitlange sokken van gerecycled badstofkatoen, met badstof met tremoreffect in teen- en hielgedeelte

2 paar

kleurvarianten:

zwart met grijze, oranje en bruine inzetstukken
grijs met zwarte, oranje en bruine inzetstukken



	EU	€		
M	39-42	15,00	1	074220102
L	43-46	15,00	1	074220104

7425

Enkelhoge sokken met ventilerende textuur inzetstukken en nylon en katoenen versteviging in hiel en teen gedeelte
Loopvlak vervaardigd uit slijtvaste, schimmelwerende, ventilerende bamboo vezels



	EU	€		
M	39-42	12,80	1	074250002
L	43-46	12,80	1	074250004

7426P

maxi sneakersokken van gerecycled badstofkatoen, met badstofkatoen in de zool en tremoreffect in teen- en hielgedeelte

2 paar

kleurvarianten:

grijs met zwarte en elektrisch blauwe inzetstukken

zwart met elektrisch blauwe en grijze inzetstukken



	EU	€		
M	39-42	14,00	1	074260102
L	43-46	14,00	1	074260104

7427

Maxi sneaker sokken met beschermende, ventilerende inzetstukken bij het scheenbeen en instappededeelte.

Nylon en katoenen versteviging in hiel en teen gedeelte. Loopvlak vervaardigd uit slijtvaste, schimmelwerende, ventilerende bamboo vezels



	EU	€		
M	39-42	11,00	1	074270002
L	43-46	11,00	1	074270004

7430T

Sneakersokken van gerecycled katoen, met badstof met tremoreffect in teen- en hielgedeelte

3 paar

kleurvarianten:

gemêleerd grijs met zwarte en bordeaux inzetstukken

zwart met grijze inzetstukken

gemêleerd grijs met zwarte inzetstukken



	EU	€		
M	39-42	18,00	1	074300202
L	43-46	18,00	1	074300204

7431P

Twee paar sneakersokken met ademend textuur inzetstukken met nylon/katoen versterking in het hiel en neus gedeelte

Ondervoet gedeelte vervaardigd uit nylon weefsel met duurzaam, schimmelwerend en ademend bamboo vezels.

een paar in zwart/oranje en een paar in zwart/grijze kleurstelling.



	EU	€		
M	39-42	9,85	1	074310102
L	43-46	9,85	1	074310104

WERKKLEDING



Gedurende de afgelopen jaren heeft de "workwear" kleding lijn het vertrouwen gewonnen en is de populariteit toegenomen onder de veeleisende professionele gebruiker.

Het succes van deze producten wordt omgezet in continue proces van ontwikkeling en uitbreiding van het assortiment.

De artikelen van de kleding lijn geproduceerd door Beta Utensili S.p.a. voldoen aan de volgende norm:

EN ISO 13688:2013

Persoonlijke bescherming middelen beschermt de gebruiker tegen fysieke gevaren, inclusief kleine schaaftwonden, zonnebrand, wind, kou, niet schadelijke stoffen en vuil van geen giftige aard. Deze bescherming is gerelateerd aan de eerste categorie van de Italiaanse wetgeving onder voorschrift n°. 475 gedateerd 04/12/1992.

GEbruik EN OPSLAG INSTRUCTIES

De kleding moet correct gedragen worden zodat het de lichaamsdelen kan beschermen. De opslag moet geschieden op een koele en droge plaats, in de originele verpakking en verwijderd van warmtebronnen, zonlicht, stof en schadelijke weersomstandigheden.

KRIMPEN

Alle natuurlijke stoffen krimpen na het wassen.

Het percentage van het krimpen varieert van 1% tot 5%, afhankelijk van verschillende factoren, waaronder het soort stof en de temperatuur van het water.

MAAT CORRESPONDENTIE

		HERENKLEDING						DAMESKLEDING							
		I	F	D	E	UK	USA			I	F	D	E	UK	USA
HERENKLEDING	XS	46	38	42	40	30	32	DAMESKLEDING	XS	38	34	32	34	6	2
	S	48	40	44	42	32	34		S	40	36	34	36	8	4
	M	50	42	46	44	34	36		M	42	38	36	38	10	6
	L	52	44	48	46	36	38		L	44	40	38	40	12	8
	XL	54	46	50	48	38	40		XL	46	42	40	42	14	10
	2XL	56	48	52	50	40	42		2XL	48	44	42	44	16	12
3XL	58	50	54	52	42	44	3XL	50	46	44	46	18	14		
4XL	60	52	56	54	44	46									
5XL	62	54	58	56	46	48									

ANATOMISCHE MATEN EN ISO 13688:2013









































HERENKLEDING		DAMESKLEDING	
A	88-92	92-96	96-104
B	79-83	83-87	87-91
H	158-164	164-170	170-176

HERENKLEDING		DAMESKLEDING	
A	104-108	108-116	116-124
B	91-95	95-100	100-107
H	182-188	188-194	194-200











KEUZEHULP VOOR KLEDING - PRIJSLIJST 2024

Categorie	Artikelnummer	Serie	Page	Kleur	Aanbevolen combinaties (zelfde stof en kleur als broek)									
					Korte broek	Page	Werkoverall, mouwloos	Page	Overalls	Page	Werkvest, mouwloos	Page	Werkjas	Page
WERKbroek, LICHTGEWICHT	7610G	Trekking	653	■	7611G	657								
	7610N		653	■										
	7660B	Top Line	653	■	7661B	657								
	7660G		653	■	7661G	657								
	7830SN	Stretch	654	■	7831SN	657								
	7860G	Beta Easy	655	■	7861G	658	7863G	658	7865G	659	7867G	661	7869G	660
	7860B		655	■	7861B	658			7865B	659	7867B	661		
7930MG	Cotton	656	■	7931MG	658			7935MG	659	7937MG	662			
WERKbroek, 4 SEIZOENEN	7600G	Trekking	652	■										
	7600N		652	■										
	7650	Top Line	653	■								7653G	660	
	7650B		653	■										
	7818BL		654	■										
	7818CM		654	■	7815CM	657								
	7818G		654	■										
	7819G		654	■										
	7830ST	Stretch	655	■	7831ST	657								
	7840BL	Beta Easy	655	■								7849BL	660	
	7850G		655	■										
	7880SC	Stretch	655	■										
	7900B		656	■								7909B	660	
	7900G	Beta Easy	656	■	7901G	658	7903G	659	7905G	659	7907G	662	7909G	660
	7900P		656	■			7903P	659				7909P	660	
7900V	656		■								7909V	660		
7940	Multiprotection	656	■								7949	661		
7818LN	Lady	654	■											

KEUZEHULP VOOR KLEDING - PRIJSLIJST 2024

Categorie	Artikelnummer	Serie	Page	Kleur	Aanbevolen combinaties (zelfde stof en kleur als broek)										
					Korte broek	Page	Werkoverall, mouwloos	Page	Overalls	Page	Werkvest, mouwloos	Page	Werkjas	Page	
WERK-JEANS	7530		652												
	7528		652		7529	657									
	7527		652												
POLO SHIRTS	7547AZ		664		MATCH MET ALLE ANDERE ITEMS VOLGENS KLEURENCOMBINATIES										
	7547BL		665												
	7547G		665												
	7547N		665												
	7547R		665												
	7557BL		666												
T-SHIRTS	7548M		665		MATCH MET ALLE ANDERE ITEMS VOLGENS KLEURENCOMBINATIES										
	7548C		665												
	7549AZ		665												
	7549BL		665												
	7549G		665												
	7549N		666												
	7549NE		666												
	7549R		666												
	7550G	Top Line	666												
7550N	666														
SHIRTS	7545F		664												
SWEATSHIRTS	7637G		663		MATCH MET ALLE ANDERE ITEMS VOLGENS KLEURENCOMBINATIES										
	7642G		663												
	7664G	Top Line	664												
	7664N		664												
	7665G		664												
	7665N		664												
7636N			663												
FLEECE/ MICROFLEECE PULLOVERS	7654B	Top Line	663												
	7654N		664												
	7657B		664												
	7657N		667												
	7575N			661		MATCH MET ALLE ANDERE ITEMS VOLGENS KLEURENCOMBINATIES									
7579QN		661													
7673NG	Top Line	661													
JASSEN EN SOFTSHELLS	7658CM	Top Line	662		MATCH MET ALLE ANDERE ITEMS VOLGENS KLEURENCOMBINATIES										
	7659N		662												
	7669N		662												
GEWATTEERDE JASSEN	7670G	Top Line	662		MATCH MET ALLE ANDERE ITEMS VOLGENS KLEURENCOMBINATIES										
	7674NG		663												
	7780QN		663												
	7750N		663												

KEUZEHULP VOOR KLEDING - PRIJSLIJST 2024

Categorie	Artikelnummer	Serie	Page	Kleur	Aanbevolen combinaties (zelfde stof en kleur als broek)										
					Korte broek	Page	Werkoverall, mouwloos	Page	Overalls	Page	Werkvest, mouwloos	Page	Werkjas	Page	
REGENDICHTE KLEDING	7970	Broek	666											7979	667
	7971L	Broek	667											7978L	667
	7981N	Regendichte hoed	668												
ACCESSOIRES	7980NC	Muts	668		MATCH MET ALLE ANDERE ITEMS VOLGENS KLEURENCOMBINATIES										
	7980RN	Muts	668												
	7980L	Muts met licht	668												
	7982N	Muts	668												
	7984EG	Riem	668												
	7984G	Riem	668												
	7985N	Nekwarmer	668												
	7996N	Technisch ondergoed	667												

PANTS



7527

werk spijkerbroek
gemaakt van 70% katoen, 27% polyester en
3% stretchstof
Normale pasvorm

CE

Jeans



Maat	l	€	CE	SKU
XS	46	66,00	1	075270046
S	48	66,00	1	075270048
M	50	66,00	1	075270050
L	52	66,00	1	075270052
XL	54	66,00	1	075270054
XXL	56	66,00	1	075270056
XXXL	58	66,00	1	075270058

7528

Stretch spijkerbroek,
98% katoen, 2% stretch stof,
slim fit

CE

Jeans



Maat	l	€	CE	SKU
XS	46	73,00	1	075280046
S	48	73,00	1	075280048
M	50	73,00	1	075280050
L	52	73,00	1	075280052
XL	54	73,00	1	075280054
XXL	56	73,00	1	075280056
XXXL	58	73,00	1	075280058

7530

stretch spijkerbroek 98% katoen and 2%
stretch stof, met polyester versterking
Slim fit

CE

Jeans



Maat	l	€	CE	SKU
XS	46	85,50	1	075300046
S	48	85,50	1	075300048
M	50	85,50	1	075300050
L	52	85,50	1	075300052
XL	54	85,50	1	075300054
XXL	56	85,50	1	075300056
XXXL	58	85,50	1	075300058

7600G

"werk trekking" broek, HEAVY,
90% nylon, 10% stretchstof, 265 g/m²,
versterkte stof op knieën en rug, elastische
broekspijpen met verticale ritsluiting
Donkergrijs, met fluorescerende groene details
Slim fit

CE

**TREKKING
HEAVY**



Maat	l	€	CE	SKU
XS	46	89,00	1	076000000
S	48	89,00	1	076000001
M	50	89,00	1	076000002
L	52	89,00	1	076000003
XL	54	89,00	1	076000004
XXL	56	89,00	1	076000005
XXXL	58	89,00	1	076000006

7600N

"werk trekking" broek, HEAVY
90% nylon, 10% stretchstof, 265 g/m²,
versterkte stof op knieën en rug, elastische
broekspijpen met verticale ritsluiting
Zwart met fluorescerende groene details
Slim fit

CE

**TREKKING
HEAVY**



Maat	l	€	CE	SKU
XS	46	89,00	1	076000100
S	48	89,00	1	076000101
M	50	89,00	1	076000102
L	52	89,00	1	076000103
XL	54	89,00	1	076000104
XXL	56	89,00	1	076000105
XXXL	58	89,00	1	076000106

7610G

"werkTrekking" Broeken, LICHT
90% nylon, 10% stretchstof, 140 g/m²,
versterkte stof op knieën en achterkant,
elastische broekspijpen en trekkoord
Donkergrijs met gele details
Slim-Fit

CE

TREKKING
LIGHT

XS	S	M	L	XL	XXL	XXXL
46	48	50	52	54	56	58
86,50	86,50	86,50	86,50	86,50	86,50	86,50
1	1	1	1	1	1	1
076100000	076100001	076100002	076100003	076100004	076100005	076100006

7610N

"werkTrekking" Broeken, LICHT
90% nylon, 10% stretchstof, 140 g/m²,
versterkte stof op knieën en rug, elastische
broekspijpen en trekkoord
Zwart met gele details
Slim-Fit

CE

TREKKING
LIGHT

XS	S	M	L	XL	XXL	XXXL
46	48	50	52	54	56	58
86,50	86,50	86,50	86,50	86,50	86,50	86,50
1	1	1	1	1	1	1
076100100	076100101	076100102	076100103	076100104	076100105	076100106

7650

Stretch werkbroeken, meerdere zakken stijl
90% nylon - 10% spandex, 260 g/m²,
anthraciet grijs
Kniebeschermingszakken, achterzakken en
pijpuiteinden versterkt met polyester 600D,
scheurbestendig kruis

CE

TOP
line

XS	S	M	L	XL	XXL	XXXL
46	48	50	52	54	56	58
115,50	115,50	115,50	115,50	115,50	115,50	115,50
1	1	1	1	1	1	1
076500000	076500001	076500002	076500003	076500004	076500005	076500006

7650B

Stretch werkbroeken, Multi-Pocket stijl,
90% nylon - 10% spandex, 260 g/m², blauw
Kniebeschermingszakken, achterzakken en
pijpuiteinde versterkt met polyester 600D,
scheurbestendig kruis

CE

TOP
line

XS	S	M	L	XL	XXL	XXXL
46	48	50	52	54	56	58
115,50	115,50	115,50	115,50	115,50	115,50	115,50
1	1	1	1	1	1	1
076500100	076500101	076500102	076500103	076500104	076500105	076500106

7660B

Stretch werkbroeken, lichtgewicht, meerdere
zakken stijl, 86% nylon - 14% spandex, 140 g/m²,
blauw
Kniebeschermingszakken, achterzakken
versterkt met polyester 300D, scheurbestendig
kruis
Slim fit

CE

TOP
line

XS	S	M	L	XL	XXL	XXXL
46	48	50	52	54	56	58
98,00	98,00	98,00	98,00	98,00	98,00	98,00
1	1	1	1	1	1	1
076600100	076600101	076600102	076600103	076600104	076600105	076600106

7660G

Stretch werkbroeken, lichtgewicht, meerdere
zakken stijl, 86% nylon - 14% spandex, 140 g/
m², anthraciet grijs Kniebeschermingszakken,
achterzakken versterkt met polyester 300D,
scheurbestendig kruis
Slim fit

CE

TOP
line

XS	S	M	L	XL	XXL	XXXL
46	48	50	52	54	56	58
98,00	98,00	98,00	98,00	98,00	98,00	98,00
1	1	1	1	1	1	1
076600000	076600001	076600002	076600003	076600004	076600005	076600006

7818G

Werkbroeken, multipocket-stijl, in T / C canvas, 260 g/m², grijs,
Kniebeschermingszakken en pijpuiteinden verstevigd met polyester 300D, scheurvast kruis en stretchstof inzetstukken in de lies en lende voor eenvoudige bewegingen

CE



Maat	L	€	U	U
XS	46	86,00	1	078180000
S	48	86,00	1	078180001
M	50	86,00	1	078180002
L	52	86,00	1	078180003
XL	54	86,00	1	078180004
XXL	56	86,00	1	078180005
XXXL	58	86,00	1	078180006

7818BL

Werkbroeken, multipocket-stijl, in T / C canvas, 260 g/m², blauw
Met stretchstof inzetstukken in de lies.
Kniebeschermingszakken en pijpuiteinden verstevigd met polyester 300D, scheur-vast kruis en stretchstof inzetstukken in de lies en lende voor eenvoudige bewegingen

CE



Maat	L	€	U	U
XS	46	86,00	1	078180100
S	48	86,00	1	078180101
M	50	86,00	1	078180102
L	52	86,00	1	078180103
XL	54	86,00	1	078180104
XXL	56	86,00	1	078180105
XXXL	58	86,00	1	078180106

7818CM

werkbroek, multipocket-stijl, gemaakt van T/C canvas, 260 g/m², camouflage grijs
Kniezakken en broekspijpen versterkt met polyester 300D, scheurvast kruis en inzetstukken van stretchstof in de binnenkant van het been en in de lendenstreek voor gemakkelijkere bewegingen

CE



Maat	L	€	U	U
XS	46	91,50	1	078180300
S	48	91,50	1	078180301
M	50	91,50	1	078180302
L	52	91,50	1	078180303
XL	54	91,50	1	078180304
XXL	56	91,50	1	078180305
XXXL	58	91,50	1	078180306

7818LN

Werkbroeken voor vrouwen, multipocket-stijl, zwart met roze details,
100% stretch katoen, 220 g /m²
Kniebeschermingszakken en pijpuiteinden verstevigd met polyester 300D, scheur-vast kruis en stretchstof inzetstukken in de lies en lende voor eenvoudige bewegingen

CE

lady



Maat	L	€	U	U
XS	38	86,00	1	078180200
S	40	86,00	1	078180201
M	42	86,00	1	078180202
L	44	86,00	1	078180203
XL	46	86,00	1	078180204
XXL	48	86,00	1	078180205
XXXL	50	86,00	1	078180206

7819G

werkbroek, model met meerdere zakken, met afneembare holster zakken, T/C canvas, 260 g/m², grijs
Zakken voor kniebeschermers en broekspijpen versterkt met polyester 300D, scheurbestendig kruis en inzetstukken van stretchstof in de binnenkant van de benen en het lendengebied voor gemakkelijkere bewegingen

CE



Maat	L	€	U	U
XS	46	75,50	1	078190000
S	48	75,50	1	078190001
M	50	75,50	1	078190002
L	52	75,50	1	078190003
XL	54	75,50	1	078190004
XXL	56	75,50	1	078190005
XXXL	58	75,50	1	078190006

7830SN

Stretch werkbroek,
in T / C Twill, 200 g/m², zwart
Slim-fit pasvorm, scheur-vast kruis en elastische-tailleband aan de zijkanten

CE

STRETCH



Maat	L	€	U	U
XS	46	75,00	1	078300100
S	48	75,00	1	078300101
M	50	75,00	1	078300102
L	52	75,00	1	078300103
XL	54	75,00	1	078300104
XXL	56	75,00	1	078300105
XXXL	58	75,00	1	078300106

7830ST

Werkbroek, stretch,
T/C twill katoen, 250 g/m², grijs
Slim fit, scheurbestendig kruis en stretch
heupband aan beide zijden

CE

STRETCH



	I	€		
XS	46	75,00	1	078300000
S	48	75,00	1	078300001
M	50	75,00	1	078300002
L	52	75,00	1	078300003
XL	54	75,00	1	078300004
XXL	56	75,00	1	078300005
XXXL	58	75,00	1	078300006

7840BL

Werkbroek, T/C twill, 245 g/m², blauw
Stretch heupband aan beide zijden

CE

Beta EASY



	I	€		
XS	46	49,50	1	078400100
S	48	49,50	1	078400101
M	50	49,50	1	078400102
L	52	49,50	1	078400103
XL	54	49,50	1	078400104
XXL	56	49,50	1	078400105
XXXL	58	49,50	1	078400106
XXXXL	60	49,50	1	078400107

7850G

Cargo werkbroeken,
100% katoen, 240 g/m²,
stretch werkbroeken aan zijkanten en grote
zijzakken met reflexinzetstukken,
grijs met fluorescerende groene details
Slim Fit

CE



	I	€		
XS	46	49,00	1	078500100
S	48	49,00	1	078500101
M	50	49,00	1	078500102
L	52	49,00	1	078500103
XL	54	49,00	1	078500104
XXL	56	49,00	1	078500105
XXXL	58	49,00	1	078500106
XXXXL	60	49,00	1	078500107

7860B

werkbroek, lichtgewicht,
van T/C-keperstof, 180 g/m², met Oxford-
inzetstukken, blauw

CE



	I	€		
XS	46	60,50	1	078600700
S	48	60,50	1	078600701
M	50	60,50	1	078600702
L	52	60,50	1	078600703
XL	54	60,50	1	078600704
XXL	56	60,50	1	078600705
XXXL	58	60,50	1	078600706
XXXXL	60	60,50	1	078600707
5XL	62	60,50	1	078600708

7860G

Werkbroeken, lichtgewicht,
in T/C keeperstof, 180 g/m², with Oxford
inzetstukken, grijs
Nieuw design - Verbeterde pasvorm

CE

Beta EASY

LIGHT



	I	€		
XS	46	60,50	1	078600800
S	48	60,50	1	078600801
M	50	60,50	1	078600802
L	52	60,50	1	078600803
XL	54	60,50	1	078600804
XXL	56	60,50	1	078600805
XXXL	58	60,50	1	078600806
XXXXL	60	60,50	1	078600807
5XL	62	60,50	1	078600808

7880SC

Werkbroek stretch,
T/C canvas, 290 g/m², zwart
Slim fit, scheurbestendig kruis en stretch
heupband op beide zijden

CE

STRETCH



	I	€		
XS	46	76,50	1	078800000
S	48	76,50	1	078800001
M	50	76,50	1	078800002
L	52	76,50	1	078800003
XL	54	76,50	1	078800004
XXL	56	76,50	1	078800005
XXXL	58	76,50	1	078800006

7900B

Werkbroeken,
in T/C canvas, 260 g/m², met Oxford
inzetstukken, blauw

CE

Beta EASY



Maat	I	€	W	L
XS	46	70,00	1	079000700
S	48	70,00	1	079000701
M	50	70,00	1	079000702
L	52	70,00	1	079000703
XL	54	70,00	1	079000704
XXL	56	70,00	1	079000705
XXXL	58	70,00	1	079000706
XXXXL	60	70,00	1	079000707

7900G

Werkbroeken,
in T/C canvas, 260 g/m², met Oxford
inzetstukken, grijs
Nieuw design - Verbeterde pasvorm

CE

Beta EASY



Maat	I	€	W	L
XS	46	70,00	1	079000800
S	48	70,00	1	079000801
M	50	70,00	1	079000802
L	52	70,00	1	079000803
XL	54	70,00	1	079000804
XXL	56	70,00	1	079000805
XXXL	58	70,00	1	079000806
XXXXL	60	70,00	1	079000807

7900P

Werkbroeken,
in T/C canvas, 260 g/m², met Oxford
inzetstukken, petrol blauw

CE

Beta EASY



Maat	I	€	W	L
XS	46	70,00	1	079000600
S	48	70,00	1	079000601
M	50	70,00	1	079000602
L	52	70,00	1	079000603
XL	54	70,00	1	079000604
XXL	56	70,00	1	079000605
XXXL	58	70,00	1	079000606
XXXXL	60	70,00	1	079000607

7900V

Werkbroeken,
in T/C canvas, 260 g/m², met Oxford
inzetstukken, groen

CE

Beta EASY



Maat	I	€	W	L
XS	46	70,00	1	079000500
S	48	70,00	1	079000501
M	50	70,00	1	079000502
L	52	70,00	1	079000503
XL	54	70,00	1	079000504
XXL	56	70,00	1	079000505
XXXL	58	70,00	1	079000506
XXXXL	60	70,00	1	079000507

7930MG

werkbroek, multipocket-model, 97% katoen,
3% stretchstof, 220 g/m², grijs

CE

Cotton



Maat	I	€	W	L
XS	46	67,50	1	079300400
S	48	67,50	1	079300401
M	50	67,50	1	079300402
L	52	67,50	1	079300403
XL	54	67,50	1	079300404
XXL	56	67,50	1	079300405
XXXL	58	67,50	1	079300406

7940

Beschermende werkbroeken
T/C twill katoen, 250 g/m², blauw,
voor bescherming tegen hitte, vlammen,
vlamboogeffecten, lasgevaren en chemicaliën.

CE



DPI: III^A Categoria
EN ISO 11611:2015 - Classe 1
EN ISO 11612:2015 - A1 B1 C1
EN 1149-5:2018
EN13034:2005+A1:2009 - Type 6
IEC 61482-2:2018 - APC 1

Maat	I	€	W	L
XS	46	103,50	1	079400000
S	48	103,50	1	079400001
M	50	103,50	1	079400002
L	52	103,50	1	079400003
XL	54	103,50	1	079400004
XXL	56	103,50	1	079400005
XXXL	58	103,50	1	079400006
XXXXL	60	103,50	1	079400007

BERMUDA



7529

Stretch korte spijkerbroek,
98% katoen, 2% stretch stof,
slim fit

CE

Jeans



	I	€		
XS	46	59,00	1	075290046
S	48	59,00	1	075290048
M	50	59,00	1	075290050
L	52	59,00	1	075290052
XL	54	59,00	1	075290054
XXL	56	59,00	1	075290056
XXXL	58	59,00	1	075290058

7611G

"WerkTrekking" Broeken, LICHT
90% nylon, 10% stretchstof, 140 g/m²,
versterkte stof op achterzijde,
Donkergrijs met gele details
Slim-Fit

CE

TREKKING
LIGHT



	I	€		
XS	46	66,00	1	076110000
S	48	66,00	1	076110001
M	50	66,00	1	076110002
L	52	66,00	1	076110003
XL	54	66,00	1	076110004
XXL	56	66,00	1	076110005
XXXL	58	66,00	1	076110006

7661B

Stretch korte werkbroecken, lichtgewicht,
meerdere zakken stijl,
86% nylon - 14% spandex, 140 g/m², blauw
Achterzakken versterkt met polyester 300D,
scheurbestendig kruis
Slim fit

CE



TOP
line



	I	€		
XS	46	85,50	1	076610100
S	48	85,50	1	076610101
M	50	85,50	1	076610102
L	52	85,50	1	076610103
XL	54	85,50	1	076610104
XXL	56	85,50	1	076610105
XXXL	58	85,50	1	076610106

7661G

Stretch korte werkbroecken, lichtgewicht,
meerdere zakken stijl,
86% nylon - 14% spandex, 140 g/m², antraciet
grijs
Achterzakken versterkt met polyester 300D,
scheurbestendig kruis
Slim fit

CE



TOP
line



	I	€		
XS	46	85,50	1	076610000
S	48	85,50	1	076610001
M	50	85,50	1	076610002
L	52	85,50	1	076610003
XL	54	85,50	1	076610004
XXL	56	85,50	1	076610005
XXXL	58	85,50	1	076610006



7815CM

werkbermuda, multipocket-stijl, gemaakt van
T/C-canvas, 260 g/m², camouflagegrijs,
scheurvast kruis en inzetstukken van
stretchstof in het binnenbeen en in de
lendenstreek voor gemakkelijkere bewegingen

CE



	I	€		
XS	46	71,00	1	078150300
S	48	71,00	1	078150301
M	50	71,00	1	078150302
L	52	71,00	1	078150303
XL	54	71,00	1	078150304
XXL	56	71,00	1	078150305
XXXL	58	71,00	1	078150306

7831SN

Stretch Bermuda Shorts,
in T / C Twill, 200 g/m², zwart
Slim-fit pasvorm, scheur-vast kruis en
elastische-tailleband aan de zijken

CE



	I	€		
XS	46	58,50	1	078310100
S	48	58,50	1	078310101
M	50	58,50	1	078310102
L	52	58,50	1	078310103
XL	54	58,50	1	078310104
XXL	56	58,50	1	078310105
XXXL	58	58,50	1	078310106

7831ST

Bermuda broek, stretch,
T/C twill, 250 g/m², grijs
Slim fit, scheurbestendig kruis en stretch
heupband aan beide zijden

CE



	I	€		
XS	46	58,50	1	078310000
S	48	58,50	1	078310001
M	50	58,50	1	078310002
L	52	58,50	1	078310003
XL	54	58,50	1	078310004
XXL	56	58,50	1	078310005
XXXL	58	58,50	1	078310006

7861G

Werk Bermuda, lichtgewicht,
in T/C keeperstof, 180 g/m², met Oxford
inzetstukken, grijs

Nieuw design - Verbeterde pasvorm

BetaEASY

CE

LIGHT



Maat	l	€	Art. N.
XS	46	54,50	1 078610800
S	48	54,50	1 078610801
M	50	54,50	1 078610802
L	52	54,50	1 078610803
XL	54	54,50	1 078610804
XXL	56	54,50	1 078610805
XXXL	58	54,50	1 078610806
XXXXL	60	54,50	1 078610807
5XL	62	54,50	1 078610808

7861B

Korte werkbreek van T/C-keeperstof, 180 g/m²,
met Oxford-inzetstukken, blauw

CE

BetaEASY

LIGHT



Maat	l	€	Art. N.
XS	46	54,50	1 078610700
S	48	54,50	1 078610701
M	50	54,50	1 078610702
L	52	54,50	1 078610703
XL	54	54,50	1 078610704
XXL	56	54,50	1 078610705
XXXL	58	54,50	1 078610706
XXXXL	60	54,50	1 078610707
5XL	62	54,50	1 078610708

Beta

7901G

Werk Bermuda,
in T/C canvas, 260 g/m², met Oxford
inzetstukken, grijs

Nieuw design - Verbeterde pasvorm

BetaEASY

CE



Maat	l	€	Art. N.
XS	46	58,50	1 079010800
S	48	58,50	1 079010801
M	50	58,50	1 079010802
L	52	58,50	1 079010803
XL	54	58,50	1 079010804
XXL	56	58,50	1 079010805
XXXL	58	58,50	1 079010806
XXXXL	60	58,50	1 079010807

7931MG

Korte werkbreek, 97% katoen, 3% stretchstof,
220 g/m², grijs

CE

Cotton



Maat	l	€	Art. N.
XS	46	54,50	1 079310400
S	48	54,50	1 079310401
M	50	54,50	1 079310402
L	52	54,50	1 079310403
XL	54	54,50	1 079310404
XXL	56	54,50	1 079310405
XXXL	58	54,50	1 079310406

OVERALLS



7863G

Werkoverall, mouwloos, lichtgewicht,
in T/C keeperstof, 180 g/m², met Oxford
inzetstukken, grijs

Nieuw design - Verbeterde pasvorm

BetaEASY

CE

LIGHT



Maat	l	€	Art. N.
XS		79,50	1 078630800
S		79,50	1 078630801
M		79,50	1 078630802
L		79,50	1 078630803
XL		79,50	1 078630804
XXL		79,50	1 078630805
XXXL		79,50	1 078630806
XXXXL		79,50	1 078630807
5XL		79,50	1 078630808

7903G

Werkoverall, mouwloos,
in T/C canvas, 260 g/m², met Oxford
inzetstukken, grijs

Nieuw design - Verbeterde pasvorm

CE

BetaEASY



	€		
XS	89,50	1	079030800
S	89,50	1	079030801
M	89,50	1	079030802
L	89,50	1	079030803
XL	89,50	1	079030804
XXL	89,50	1	079030805
XXXL	89,50	1	079030806
XXXXL	89,50	1	079030807

7903P

Overall, mouwloos,
in T/C canvas, 260 g/m², met Oxford
inzetstukken, petrol blauw

CE

BetaEASY



	€		
XS	89,50	1	079030600
S	89,50	1	079030601
M	89,50	1	079030602
L	89,50	1	079030603
XL	89,50	1	079030604
XXL	89,50	1	079030605
XXXL	89,50	1	079030606
XXXXL	89,50	1	079030607

7865B

werkoverall, lichtgewicht,
van T/C-keperstof, 180 g/m², met Oxford-
inzetstukken, blauw

CE

BetaEASY

LIGHT



	€		
XS	103,50	1	078650700
S	103,50	1	078650701
M	103,50	1	078650702
L	103,50	1	078650703
XL	103,50	1	078650704
XXL	103,50	1	078650705
XXXL	103,50	1	078650706
XXXXL	103,50	1	078650707
5XL	103,50	1	078650708

7865G

Werkoverall, lichtgewicht,
in T/C keperstof, 180 g/m², met Oxford
inzetstukken, grijs

Nieuw design - Verbeterde pasvorm

CE

BetaEASY

LIGHT



	€		
XS	103,50	1	078650800
S	103,50	1	078650801
M	103,50	1	078650802
L	103,50	1	078650803
XL	103,50	1	078650804
XXL	103,50	1	078650805

	€		
XXXL	103,50	1	078650806
XXXXL	103,50	1	078650807
5XL	103,50	1	078650808

7905G

Werkoverall,
in T/C canvas, 260 g/m², met Oxford
inzetstukken, grijs

Nieuw design - Verbeterde pasvorm

BetaEASY

CE



	€		
XS	109,00	1	079050800
S	109,00	1	079050801
M	109,00	1	079050802
L	109,00	1	079050803
XL	109,00	1	079050804
XXL	109,00	1	079050805
XXXL	109,00	1	079050806
XXXXL	109,00	1	079050807

7935MG

werkoverall, 97% katoen, 3% stretchstof,
220 g/m², grijs

CE

Cotton



	€		
XS	125,00	1	079350400
S	125,00	1	079350401
M	125,00	1	079350402
L	125,00	1	079350403
XL	125,00	1	079350404
XXL	125,00	1	079350405
XXXL	125,00	1	079350406

WORK JACKETS



7653G

stretch werkjack, multipocket-stijl, 90% nylon -10% spandex, 260 g/m², antracietgrijs

CE



TOP line



Maat	€	Stuk	Artikelnummer
XS	112,50	1	076530000
S	112,50	1	076530001
M	112,50	1	076530002
L	112,50	1	076530003
XL	112,50	1	076530004
XXL	112,50	1	076530005
XXXL	112,50	1	076530006

7849BL

Werkjas, T/C twill, 245 g/m², blauw
Stretch heupband

CE

Beta EASY



Maat	€	Stuk	Artikelnummer
XS	52,00	1	078490100
S	52,00	1	078490101
M	52,00	1	078490102
L	52,00	1	078490103
XL	52,00	1	078490104
XXL	52,00	1	078490105
XXXL	52,00	1	078490106
XXXXL	52,00	1	078490107

7869G

Werkjas, lichtgewicht, in T/C keeperstof, 180 g/m², met Oxford inzetstukken, grijs
Nieuw design - Verbeterde pasvorm

CE

Beta EASY

LIGHT



Maat	€	Stuk	Artikelnummer
XS	70,50	1	078690800
S	70,50	1	078690801
M	70,50	1	078690802
L	70,50	1	078690803
XL	70,50	1	078690804
XXL	70,50	1	078690805
XXXL	70,50	1	078690806
XXXXL	70,50	1	078690807
5XL	70,50	1	078690808

7909B

Werkjas, in T/C canvas, 260 g/m², met Oxford inzetstukken, blauw

CE

Beta EASY



Maat	€	Stuk	Artikelnummer
XS	77,50	1	079090700
S	77,50	1	079090701
M	77,50	1	079090702
L	77,50	1	079090703
XL	77,50	1	079090704
XXL	77,50	1	079090705
XXXL	77,50	1	079090706
XXXXL	77,50	1	079090707

7909G

Werkjas, in T/C canvas, 260 g/m², met Oxford inzetstukken, grijs
Nieuw design - Verbeterde pasvorm

CE

Beta EASY



Maat	€	Stuk	Artikelnummer
XS	77,50	1	079090800
S	77,50	1	079090801
M	77,50	1	079090802
L	77,50	1	079090803
XL	77,50	1	079090804
XXL	77,50	1	079090805
XXXL	77,50	1	079090806
XXXXL	77,50	1	079090807

7909P

Werkjas, in T/C canvas, 260 g/m², met Oxford inzetstukken, petrol blauw

CE

Beta EASY



Maat	€	Stuk	Artikelnummer
XS	77,50	1	079090600
S	77,50	1	079090601
M	77,50	1	079090602
L	77,50	1	079090603
XL	77,50	1	079090604
XXL	77,50	1	079090605
XXXL	77,50	1	079090606
XXXXL	77,50	1	079090607

7909V

Werkjas, in T/C canvas, 260 g/m², met Oxford inzetstukken, groen

CE

Beta EASY



Maat	€	Stuk	Artikelnummer
XS	77,50	1	079090500
S	77,50	1	079090501
M	77,50	1	079090502
L	77,50	1	079090503
XL	77,50	1	079090504
XXL	77,50	1	079090505
XXXL	77,50	1	079090506
XXXXL	77,50	1	079090507

Beta

7949

Beschermende werkjassen,
T/C twill katoen 250 g/m², blauw,
voor bescherming tegen hitte, vlammen,
vlamboogeffecten, lasgevaren en chemicaliën

CE

DPI: III^A Categoria
EN ISO 11611:2015 - Classe 1
EN ISO 11612:2015 - A1 B1 C1
EN 1149-5:2018
EN13034:2005+A1:2009 - Type 6
IEC 61482-2:2018 - APC 1



7940

656

Maat	€	Stuk	Artikelnummer
XS	119,50	1	079490000
S	119,50	1	079490001
M	119,50	1	079490002
L	119,50	1	079490003
XL	119,50	1	079490004
XXL	119,50	1	079490005
XXXL	119,50	1	079490006
XXXXL	119,50	1	079490007

SLEEVELESS JACKETS



7575N

Softshell bodywarmer,
90% nylon, 10% stretch stof, 250 g/m²



Maat	€	Stuk	Artikelnummer
S	107,00	1	075750301
M	107,00	1	075750302
L	107,00	1	075750303
XL	107,00	1	075750304
XXL	107,00	1	075750305
XXXL	107,00	1	075750306

7579QN

Bodywarmer, multipocket-stijl, gemaakt van
dubbel materiaal.
100% waterdicht nylon 300D en softshell stof,
96% polyester, 4% spandex, polyester
gewatteerd, 160 g/m²
zwart/antracietgrijs

CE



Maat	€	Stuk	Artikelnummer
S	89,50	1	075790201
M	89,50	1	075790202
L	89,50	1	075790203
XL	89,50	1	075790204
XXL	89,50	1	075790205
XXXL	89,50	1	075790206

7673NG

Bodywarmer met GRAPHENE voering, 80 g/m²,
Borstzijde versterkt met softshell materiaal
- 96% polyester, 4% spandex; rugzijde
vervaardigd uit 100% nylon 20D
antraciet grijs (borst), zwart (rug)
Stretch inzetstukken in armgaten
Antistatisch, antibacterieel, winddicht

CE

TOP
Line



Maat	€	Stuk	Artikelnummer
S	116,50	1	076730001
M	116,50	1	076730002
L	116,50	1	076730003
XL	116,50	1	076730004
XXL	116,50	1	076730005
XXXL	116,50	1	076730006

Beta

Beta

7867B

Bodywarmer, lichtgewicht, van T/C-keperstof,
180 g/m², met Oxford-inzetstukken, blauw

CE

Beta EASY

LIGHT



Maat	€	Stuk	Artikelnummer
XS	61,00	1	078670700
S	61,00	1	078670701
M	61,00	1	078670702
L	61,00	1	078670703
XL	61,00	1	078670704
XXL	61,00	1	078670705
XXXL	61,00	1	078670706
XXXXL	61,00	1	078670707
5XL	61,00	1	078670708

7867G

Werkvest, lichtgewicht,
in T/C keperstof, 180 g/m², met Oxford
inzetstukken, grijs
Nieuw design - Verbeterde pasvorm

CE

Beta EASY

LIGHT



Maat	€	Stuk	Artikelnummer
XS	61,00	1	078670800
S	61,00	1	078670801
M	61,00	1	078670802
L	61,00	1	078670803
XL	61,00	1	078670804
XXL	61,00	1	078670805
XXXL	61,00	1	078670806
XXXXL	61,00	1	078670807
5XL	61,00	1	078670808

7907G

Werkvest,
in T/C canvas, 260 g/m², met Oxford
inzetstukken, grijs
Nieuw design - Verbeterde pasvorm

CE

Beta EASY



	€		
XS	63,00	1	079070800
S	63,00	1	079070801
M	63,00	1	079070802
L	63,00	1	079070803
XL	63,00	1	079070804
XXL	63,00	1	079070805
XXXL	63,00	1	079070806
XXXXL	63,00	1	079070807

7937MG

bodywarmer, 97% katoen, 3% stretchstof,
220 g/m², grijs

CE

Cotton



	€		
XS	65,00	1	079370400
S	65,00	1	079370401
M	65,00	1	079370402
L	65,00	1	079370403
XL	65,00	1	079370404
XXL	65,00	1	079370405
XXXL	65,00	1	079370406

JACKETS



7658CM

Softshell jas, 94% polyester, 6% spandex, 290 g/m²,
camouflage grijs
Met waterafstotend, winddichte en ademend
TPU membraan
(weerstand tegen waterkolom tot 8,000 mm -
ademend 8,000 mvp)

TOP
line



	€		
S	144,00	1	076580101
M	144,00	1	076580102
L	144,00	1	076580103
XL	144,00	1	076580104
XXL	144,00	1	076580105
XXXL	144,00	1	076580106

7659N

Softshell jas, 94% polyester, 6% spandex, 290 g/m²,
met afneembare capuchon en mouwen, zwart
Met een waterafstotende, winddichte en ademend
TPU membraan (weerstand tegen waterkolom tot
8,000 mm - ademend 8,000 mvp)

TOP
line



	€		
S	196,50	1	076590001
M	196,50	1	076590002
L	196,50	1	076590003
XL	196,50	1	076590004
XXL	196,50	1	076590005
XXXL	196,50	1	076590006

7669N

Stretch werkjas, lichtgewicht, meerdere zakken
stijl, 86% nylon, 14% spandex, 140 g/m², black
Met afneembare mouwen en instelbare
capuchon.
Waterbestendig en winddicht

4-WAY
STRETCH

TOP
line



	€		
XS	134,00	1	076690000
S	134,00	1	076690001
M	134,00	1	076690002
L	134,00	1	076690003
XL	134,00	1	076690004
XXL	134,00	1	076690005
XXXL	134,00	1	076690006

7670G

Anorak jas vervaardigd uit Oxford polyester
300D,
waterafstotend, PU-coating, antraciet grijs
Met afneembare capuchon en versterkte
mouwen.

Waterafstotend, winddicht en ademend
(weerstand tegen water kolom tot 2,000 mm -
ademend 2,000 mvp)

Polyester 210T voering, polyester vulling, 120
g/m² body, 100 g/m² mouwen

CE

TOP
line



	€		
S	134,00	1	076700001
M	134,00	1	076700002
L	134,00	1	076700003
XL	134,00	1	076700004
XXL	134,00	1	076700005
XXXL	134,00	1	076700006

Beta

Beta



7674NG

Gewatteerde werkjas met GRAPHENE voering, 80 g/m², Borstzijde en voorzijde mouwen versterkt met softshell materiaal - 96% polyester, 4% spandex, rugzijde en mouwen vervaardigd uit 100% nylon 20D antraciet grijs (borst), zwart (rug) Elastische manchetten Antistatisch, antibacterieel, winddicht

CE

TOP line



	€		
S	144,00	1	076740001
M	144,00	1	076740002
L	144,00	1	076740003
XL	144,00	1	076740004
XXL	144,00	1	076740005
XXXL	144,00	1	076740006

7780QN

bomberjack, multipocket-stijl, gemaakt van dubbel materiaal. 100% waterdicht nylon 300D en softshell stof, 96% polyester, 4% spandex, polyester vulling, 160 g/m² met vaste capuchon zwart/antracietgrijs

CE



	€		
S	155,00	1	077800201
M	155,00	1	077800202
L	155,00	1	077800203
XL	155,00	1	077800204
XXL	155,00	1	077800205
XXXL	155,00	1	077800206

7750N

werkbomberjack, model met meerdere zakken, 100% polyester, 100% polyester wattering, 120 g/m², zwart

CE



	€		
XS	83,00	1	077500000
S	83,00	1	077500001
M	83,00	1	077500002
L	83,00	1	077500003
XL	83,00	1	077500004
XXL	83,00	1	077500005
XXXL	83,00	1	077500006

FLEECE



7636N

microfleece trui, korte ritssluiting, 180 g/m² zwart met reflecterende details



	€		
XS	29,00	1	076360500
S	29,00	1	076360501
M	29,00	1	076360502
L	29,00	1	076360503
XL	29,00	1	076360504
XXL	29,00	1	076360505
XXXL	29,00	1	076360506

7637G

Technisch fleece sweatshirt met inzetstukken van softshell-stof, om in elke situatie warm en comfortabel te blijven en tegelijkertijd modern uit te zien



	€		
XS	103,50	1	076370000
S	103,50	1	076370001
M	103,50	1	076370002
L	103,50	1	076370003
XL	103,50	1	076370004
XXL	103,50	1	076370005
XXXL	103,50	1	076370006

7642G

Sweater met ronde hals, 240 g/m², 60% katoen, 40% polyester, gemêleerd grijs, zwarte inzetstukken



	€		
XS	34,00	1	076420000
S	34,00	1	076420001
M	34,00	1	076420002
L	34,00	1	076420003
XL	34,00	1	076420004
XXL	34,00	1	076420005
XXXL	34,00	1	076420006

7654B

Stretch microfleece sweater, korte ritssluiting, 180 g/m², blauw 95% polyester, 5% spandex

4-WAY STRETCH

TOP line



	€		
XS	58,00	1	076540100
S	58,00	1	076540101
M	58,00	1	076540102
L	58,00	1	076540103
XL	58,00	1	076540104
XXL	58,00	1	076540105
XXXL	58,00	1	076540106

7654N

Stretch microfleece trui, korte ritssluiting, 180 g/m², zwart
95% polyester, 5% spandex



TOP
line



MAAT	€	ST	ART
XS	58,00	1	076540000
S	58,00	1	076540001
M	58,00	1	076540002
L	58,00	1	076540003
XL	58,00	1	076540004
XXL	58,00	1	076540005
XXXL	58,00	1	076540006

7657B

Stretch fleece sweater, lange ritssluiting, 280 g/m², blauw
95% polyester, 5% spandex



TOP
line



MAAT	€	ST	ART
XS	72,50	1	076570100
S	72,50	1	076570101
M	72,50	1	076570102
L	72,50	1	076570103
XL	72,50	1	076570104
XXL	72,50	1	076570105
XXXL	72,50	1	076570106

7657N

Stretch fleece trui, lange ritssluiting, 280 g/m², zwart
95% polyester, 5% spandex



TOP
line



MAAT	€	ST	ART
XS	72,50	1	076570000
S	72,50	1	076570001
M	72,50	1	076570002
L	72,50	1	076570003
XL	72,50	1	076570004
XXL	72,50	1	076570005
XXXL	72,50	1	076570006

7664G

Sweatshirt, lange ritssluiting, 280 g/m², grijs
60% katoen, 40% polyester

TOP
line



MAAT	€	ST	ART
XS	63,00	1	076640100
S	63,00	1	076640101
M	63,00	1	076640102
L	63,00	1	076640103
XL	63,00	1	076640104
XXL	63,00	1	076640105
XXXL	63,00	1	076640106

7664N

Sweatshirt, lange ritssluiting, 280 g/m², zwart
60% katoen, 40% polyester

TOP
line



MAAT	€	ST	ART
XS	63,00	1	076640000
S	63,00	1	076640001
M	63,00	1	076640002
L	63,00	1	076640003
XL	63,00	1	076640004
XXL	63,00	1	076640005
XXXL	63,00	1	076640006

7665G

Hoodie, lange ritssluiting, 280 g/m², grijs
60% katoen, 40% polyester

TOP
line



MAAT	€	ST	ART
XS	68,50	1	076650100
S	68,50	1	076650101
M	68,50	1	076650102
L	68,50	1	076650103
XL	68,50	1	076650104
XXL	68,50	1	076650105
XXXL	68,50	1	076650106

7665N

Hoodie, lange ritssluiting, 280 g/m², zwart
60% katoen, 40% polyester

TOP
line



MAAT	€	ST	ART
XS	68,50	1	076650000
S	68,50	1	076650001
M	68,50	1	076650002
L	68,50	1	076650003
XL	68,50	1	076650004
XXL	68,50	1	076650005
XXXL	68,50	1	076650006

SHIRT & T-SHIRT

7545F

Kariertes Arbeitshemd aus Flanell, 100 %
Baumwolle, 190 g/m²



MAAT	€	ST	ART
XS	48,50	1	075450200
S	48,50	1	075450201
M	48,50	1	075450202
L	48,50	1	075450203
XL	48,50	1	075450204
XXL	48,50	1	075450205
XXXL	48,50	1	075450206

7547AZ

Polo-shirt met drie knoppen,
100% katoen, 200 g/m², lichtblauw



MAAT	€	ST	ART
XS	36,00	2	075470500
S	36,00	2	075470501
M	36,00	2	075470502
L	36,00	2	075470503
XL	36,00	2	075470504
XXL	36,00	2	075470505
XXXL	36,00	2	075470506

7547BL

Polo shirt, 3 knoops
100% katoen, 200 g/m², blauw



	€		
XS	36,00	2	075470200
S	36,00	2	075470201
M	36,00	2	075470202
L	36,00	2	075470203
XL	36,00	2	075470204
XXL	36,00	2	075470205
XXXL	36,00	2	075470206

7547G

Polo shirt, 3 knoops
100% katoen, 200 g/m², grijs



	€		
XS	36,00	2	075470300
S	36,00	2	075470301
M	36,00	2	075470302
L	36,00	2	075470303
XL	36,00	2	075470304
XXL	36,00	2	075470305
XXXL	36,00	2	075470306

7547N

Polo shirt, 3 knoops
100% katoen, 200 g/m², zwart



	€		
XS	36,00	2	075470400
S	36,00	2	075470401
M	36,00	2	075470402
L	36,00	2	075470403
XL	36,00	2	075470404
XXL	36,00	2	075470405
XXXL	36,00	2	075470406

7547R

Polo-shirt met drie knoppen,
100% katoen, 200 g/m², rood



	€		
XS	36,00	2	075470600
S	36,00	2	075470601
M	36,00	2	075470602
L	36,00	2	075470603
XL	36,00	2	075470604
XXL	36,00	2	075470605
XXXL	36,00	2	075470606

7548M

modern bedrukt t-shirt, 100% katoen, 150 g/m²



	€		
XS	32,00	1	075480400
XL	32,00	1	075480404
S	32,00	1	075480401
M	32,00	1	075480402
L	32,00	1	075480403
XXL	32,00	1	075480405
XXXL	32,00	1	075480406

7548C

T-shirt met klassieke print, 100% katoen, 150 g/m²



	€		
XS	32,00	1	075480500
S	32,00	1	075480501
M	32,00	1	075480502
L	32,00	1	075480503
XL	32,00	1	075480504
XXL	32,00	1	075480505
XXXL	32,00	1	075480506

7549AZ

T-shirt, 100% katoen, 150 g/m², lichtblauw



	€		
XS	22,50	5	075490500
S	22,50	5	075490501
M	22,50	5	075490502
L	22,50	5	075490503
XL	22,50	5	075490504
XXL	22,50	5	075490505
XXXL	22,50	5	075490506

7549BL

T-shirt, 100% katoen, 150 g/m², blauw



	€		
XS	22,50	5	075490200
S	22,50	5	075490201
M	22,50	5	075490202
L	22,50	5	075490203
XL	22,50	5	075490204
XXL	22,50	5	075490205
XXXL	22,50	5	075490206

7549G

T-shirt, 100% katoen, 150 g/m², grijs



	€		
XS	22,50	5	075490300
S	22,50	5	075490301
M	22,50	5	075490302
L	22,50	5	075490303
XL	22,50	5	075490304
XXL	22,50	5	075490305
XXXL	22,50	5	075490306

7549NE

werk t-shirt, gemaakt van 100% katoen, 150 g/m², zwart



Maat	€	Stuks	Artikelnummer
XS	22,50	5	075490700
S	22,50	5	075490701
M	22,50	5	075490702
L	22,50	5	075490703
XL	22,50	5	075490704
XXL	22,50	5	075490705
XXXL	22,50	5	075490706

7549N

T-shirt, 100% katoen, 150 g/m², zwart



Maat	€	Stuks	Artikelnummer
XS	22,50	5	075490400
S	22,50	5	075490401
M	22,50	5	075490402
L	22,50	5	075490403
XL	22,50	5	075490404
XXL	22,50	5	075490405
XXXL	22,50	5	075490406

7549R

T-shirt, 100% katoen, 150 g/m², rood



Maat	€	Stuks	Artikelnummer
XS	22,50	5	075490600
S	22,50	5	075490601
M	22,50	5	075490602
L	22,50	5	075490603
XL	22,50	5	075490604
XXL	22,50	5	075490605
XXXL	22,50	5	075490606

7550G

technisch werk t-shirt, gemaakt van polyester, 120 g/m², met 37.5°-technologie, grijs met zwarte, oranje en reflecterende details



Maat	€	Stuks	Artikelnummer
XS	49,00	1	075500400
S	49,00	1	075500401
M	49,00	1	075500402
L	49,00	1	075500403
XL	49,00	1	075500404
XXL	49,00	1	075500405
XXXL	49,00	1	075500406

7550N

technisch werk t-shirt, gemaakt van polyester, 120 g/m² met 37.5°-technologie, zwart met grijze, oranje en reflecterende details



Maat	€	Stuks	Artikelnummer
XS	49,00	1	075500500
S	49,00	1	075500501
M	49,00	1	075500502
L	49,00	1	075500503
XL	49,00	1	075500504
XXL	49,00	1	075500505
XXXL	49,00	1	075500506

7557BL

Drieknoops polo shirt, lange mouwen, 100% katoen, 200 g/m², blauw



Maat	€	Stuks	Artikelnummer
XS	42,00	1	075570200
S	42,00	1	075570201
M	42,00	1	075570202
L	42,00	1	075570203
XL	42,00	1	075570204
XXL	42,00	1	075570205
XXXL	42,00	1	075570206

RAIN

7970

broek, waterdicht, gemaakt van PVC-tricot, blauw
ZOLANG DE VOORRAAD STREKT

CE



EN 343

Maat	€	Stuks	Artikelnummer
XS	51,00	1	079700000
S	51,00	1	079700001
M	51,00	1	079700002
L	51,00	1	079700003
XL	51,00	1	079700004
XXL	51,00	1	079700005
XXXL	51,00	1	079700006



7971L

Waterafstotende werkbreek, vervaardigd uit PVC gelaagd polyester, met thermisch gelaste naden, blauw. Met elastische heupband en met drukknopen verstelbare pijpuiteinden

CE



EN 343

	€	M	PC
XS	28,50	1	079710100
S	28,50	1	079710101
M	28,50	1	079710102
L	28,50	1	079710103
XL	28,50	1	079710104
XXL	28,50	1	079710105
XXXL	28,50	1	079710106

7978L

Waterafstotend lange jas, vervaardigd uit PVC-gelaagd polyester, met vaste capuchon en thermisch gelaste naden, blauw. Voorzien van drukknopen en te gebuiken als een 3/4 lengte jas

CE



EN 343

	€	M	PC
XS	39,50	1	079780100
S	39,50	1	079780101
M	39,50	1	079780102
L	39,50	1	079780103
XL	39,50	1	079780104
XXL	39,50	1	079780105
XXXL	39,50	1	079780106

7979

jas, waterdicht, gemaakt van PVC tricot, blauw
ZOLANG DE VOORRAAD STREKT

CE



EN 343

	€	M	PC
S	81,50	1	079790001
M	81,50	1	079790002
L	81,50	1	079790003
XL	81,50	1	079790004
XXL	81,50	1	079790005
XXXL	81,50	1	079790006

UNDERWEAR

7996N

Technisch ondergoed set - bestaande uit een onderhemd met lange mouwen + onderbroek, 92% polyester, 8% spandex, 160 g/m², zwart



	€	M	PC
XS-S	47,00	1	079960000
M-L	47,00	1	079960002
XL-XXL	47,00	1	079960004



ACCESSORIES

7800G

Knie stootstukken, per paar



7800G € 16,10 1 078000500

7980L

wintermuts met oplaadbaar LED-licht en 100% acryl manchet
LED-lamp met 3 helderheidsinstellingen, tot 60 lumen
één maat past allemaal
zwart

- Oplaadbaar via USB-poort
- Lichthelderheid: tot 60 lumen
- Oplaadtijd: 80 minuten
- Levensduur batterij: 85 ÷ 290 minuten



7980L € 15,00 10 079800200

7980NC

Fleece wintermuts, 100% polyester, omkeerbaar (dubbelzijdig), camouflage zwart



7980NC € 15,40 10 079800112

7980RN

wintermuts met boord, 100% acryl, gevoerd met 3M Thinsulate™, slechts één maat
zwart



7980RN € 12,60 10 079800120

7981N

Regenbestendige pet, 100% PU-gecoate nylon, met waterafstotende behandeling



L = Ø 58 cm	€ 22,10	1	079810158
XL = Ø 60 cm	€ 22,10	1	079810160

7982N

Pet, 100% polyester, riemsluiting, zwart



7982N € 9,50 10 079820000

7984EG

riem van stretchstof, metalen gesp met satijnen afwerking, one size fits all, 120cm, inkortbaar, breedte 37 mm, grijs



7984EG € 29,00 1 079840520

7984G

Broekriem, 100% TPE, met verchromde zinken gesp
"one size fits all"; lengte: 125 cm, kan ingekort worden; breedte: 35 mm, zwart



7984G € 20,20 1 079840525

7985N

microfleece nekw warmer met koordregelaar, ook als kap te gebruiken, zwart met grijze en reflecterende details



7985N € 12,60 10 079850000



7104 90

Kunststof afzetpalen met vulbare voeten



7104 90	H mm 90	€ 31,00	4	071040004
---------	---------	---------	---	-----------

7105 6

Kunststof afzet ketting



7105 6	Ø mm 6	L m 25	€ 71,50	1	071050006
--------	--------	--------	---------	---	-----------

7109A

Aluminium waarschuwingstekens



7109A 1	H mm 140	€ 13,10	1	071090001
7109A 2	140	13,10	1	071090002
7109A 3	140	13,10	1	071090003
7109A 4	140	13,10	1	071090004

7109D

waarschuwingstekens



7109D 1	H mm 115	€ 13,10	1	071090051
7109D 2	115	13,10	1	071090052
7109D 3	115	13,10	1	071090053



7061TC

Veiligheidsbril met helder glas uit polycarbonaat



EN166:2001
EN170
2C-1.2 1F

7061TC € 12,00 1 070610001

7076BC

Veiligheidsbril met helder glas uit polycarbonaat



EN166:2001
EN172
5-1.7 1F

7076BC € 22,70 1 070760009

7076BD

Veiligheidsbril met helder glas uit polycarbonaat



EN166:2001
EN172
5-3.1 1F

7076BD € 22,70 1 070760019

7076BP

Veiligheidsbril met gepolariseerd glas uit polycarbonaat



EN ISO 12312-1:2013+A1:2015
EN 1836
3P

7076BP € 38,00 1 070760029

7076BU

veiligheidsbril met oranje polycarbonaat lenzen



EN ISO 12311:2013
UV 500

7076BU € 19,90 1 070760039

7093BC

Veiligheidsbril met helder glas uit polycarbonaat



EN166:2001
EN170
2C-1.2 1F

7093BC € 35,50 1 070930009

7093BD

Veiligheidsbril met donker glas uit polycarbonaat



EN166:2001
EN172
5-3.1 1F

7093BD € 35,50 1 070930019



C62M/WW

paspop, realistisch formaat, metalen voet



185 cm

C62M/WW € 249,00 1 062000362

C64

wanddisplay voor kleding en schoenen, leeg



2400 mm

560 mm

L	€	1	064000021
1 m	1.575,00	1	064000021
2 m	2.840,00	1	064000022
3 m	4.110,00	1	064000023
4 m	5.380,00	1	064000024

C64G

Gondola display voor kleding en schoenen, leeg

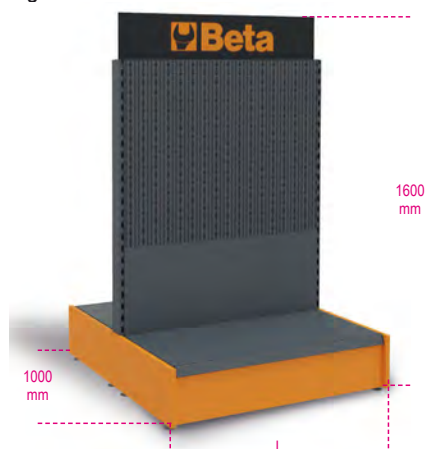

L	€	1	064000051
1 m	1.935,00	1	064000051
2 m	3.510,00	1	064000052

C64CW

Kleedcabine



C64CW	€	1	064000610
	642,00	1	064000610

6200AP/S10

Set van 10 kledingshangers



6200AP/S10	€	1	062000331
	44,50	1	062000331

6800BA



6800BA	€	1	068000130
	140,00	1	068000130

6800RS



6800RS	€	1	068000135
	139,00	1	068000135

6888GS

schoenenhaak voor display C64



6888GS	€	2	068880122
	30,00	2	068880122

170x120 mm

6888GW

haak voor display C64



6888GW	€	2	068880121
	9,10	2	068880121

400 mm

9562TB

Vloermat voor het passen van schoenen, met anti-slip, onderkant voorzien van rubber laag



9562TB	L mm	H mm	€	1	095620500
	800	600	60,00	1	095620500

9565S

Plaatstalen vat met krukjes voorzien van afneembare imitatie leren kussens



9565S	H cm	ø cm	€	1	095650300
	60	38		1	095650300

Beta



Robur

Sinds 1930 produceert Robur toebehoren voor kabels volgens de bekende Beta Utensili kwaliteit standards, waarvan de producten aanvullend zijn aan die van Robur.

Deskundigheid, organisatie en technologie zijn de hoofdingrediënten van een doorlopende groei, resulterend uit bekendheid met de gestelde markteisen.

Sinds 1984 is het hoofdkantoor van Robur gevestigd in een moderne productie faciliteit in Sulmona.



Speciale service verpakking

MAXIMALE WERKBELASTING

WLL: maximale constante belasting (voor hijsproducten)

WFL: Maximaal toegestane kracht (voor toebehoren ander dan hef en hijstoebereiden)

BF: maximale kracht bereikt tijdens statische tractie test

LC: sjorcapaciteit

nieuwe artikelen
2024

8134

Magnetische lifters

CE



EN13155

Technische data:
• Veiligheidsfactor: 3
• Identificatie bewijs

Beschikbare certificaten:
• Certificaat van de fabrikant
• Verklaring van conformiteit met machinerichtlijn 2006/42/EC
• Testrapport Uni EN10204 Type 2.2
• Handleiding voor bediening en onderhoud

afmeting

verpakkingseenheid

prijs per stuk

code nummer

WLL	A	B	C	€	code nummer
kg	mm	mm	mm		
100	70	64	92	473,00	1 081340010
300	96	88	165	830,00	1 081340030
600	120	118	230	1.545,00	1 081340060
1000	168	168	264	2.560,00	1 081340100

8105

Spanschroeven met twee ogen hoog rekbaar
staal gegalvaniseerd

CE



TECHNISCHE DATA

- Veiligheids factor: 5
- Hittebehandeling, behuizing: genormaliseerd
- Hittebehandeling, ogen: gehard en getemperd

LABORATORIUM TEST

- Chemische analyse
- Treksterkte test

VERKIRJGBARE CERTIFICATEN

- Technische product specificaties
- Test rapport UNI EN10204 type 2.2

ØxE	≈	WLL	€		
"	mm	kg			
3/8x6	M10x150	540	15,40	5	081050010
1/2x6	M12x150	1000	25,50	5	081050011
1/2x9	M12x230	1000	33,00	5	081050012
5/8x6	M16x150	1590	39,00	2	081050014
5/8x9	M16x230	1590	48,00	2	081050016
5/8X12	M16X300	1590	57,50	2	081050015
3/4x6	M20x150	2360	61,50	2	081050017
3/4x9	M20x230	2360	71,50	2	081050020
3/4x12	M20x300	2360	86,00	2	081050018
3/4x18	M20x460	2360	112,50	2	081050021
7/8x12	M22x300	3270	121,00	1	081050022
1x6	M24x150	4540	128,50	1	081050024
1x12	M24x300	4540	184,50	1	081050025
1x18	M24X460	4540	217,00	1	081050026
1.1/4x12	M33x300	6900	315,00	1	081050031
1.1/4x18	M33x460	6900	325,00	1	081050032
1.1/4x24	M33x610	6900	436,00	1	081050033
1.1/2x12	M39x300	9710	390,00	1	081050034
1.1/2x18	M39x460	9710	473,00	1	081050035
1.3/4x18	M45x460	12700	717,00	1	081050036

Speciale service verpakking



ØxE	€		
"			
3/8x6	1	16,70	081059010
1/2x9	1	34,50	081059012

Robur

8109

Spanschroeven met twee gaffels hoog rekbaar
staal gegalvaniseerd

CE



TECHNISCHE DATA

- Veiligheids factor: 5
- Hittebehandeling, behuizing: genormaliseerd
- Hittebehandeling, ogen: gehard en getemperd

LABORATORIUM TEST

- Chemische analyse
- Treksterkte test

VERKIRJGBARE CERTIFICATEN

- Technische product specificaties
- Test rapport UNI EN10204 type 2.2

ØxE	≈	WLL	€		
"	mm	kg			
3/8x6	M10x150	540	19,90	5	081090010
1/2x6	M12x150	1000	33,50	5	081090011
1/2x9	M12x230	1000	39,00	5	081090012
1/2x12	M12x300	1000	50,00	5	081090013
5/8x6	M16x150	1590	60,00	2	081090015
5/8x9	M16x230	1590	71,00	2	081090016
5/8X12	M16X300	1590	79,50	2	081090017
3/4x6	M20x150	2360	83,50	2	081090018
3/4x9	M20x230	2360	97,50	2	081090020
3/4x12	M20x300	2360	108,50	2	081090019
3/4x18	M20x460	2360	129,00	2	081090021
7/8x12	M22x300	3270	162,50	1	081090022
7/8x18	M22x460	3270	196,50	1	081090023
1x6	M24x150	4540	161,00	1	081090024
1x12	M24x300	4540	230,50	1	081090025
1x18	M24x460	4540	267,00	1	081090026
* 1.1/4x12	M33x300	6900	375,00	1	081090031
* 1.1/4x18	M33x460	6900	420,00	1	081090032
* 1.1/4x24	M33x610	6900	582,00	1	081090033
* 1.1/2x12	M39x300	9710	543,00	1	081090034
* 1.1/2x18	M39x460	9710	622,00	1	081090038
* 1.1/2x24	M39x610	9710	745,00	1	081090039
* 1.3/4X18	M45x460	12700	907,00	1	081090036

Speciale service verpakking



ØxE	€		
"			
3/8x6	1	21,30	081099010
1/2x9	1	40,00	081099012

8110

Spanschroef, oog en gaffel, staal met hoge
treksterkte, heet gegalvaniseerd

CE



TECHNISCHE DATA

- Veiligheidsfactor: 5
- Hittebehandeling behuizing: genormaliseerd
- Hittebehandeling oog: gehard en getemperd

LABORATORIUM TESTS

- Chemische analyse
- Treksterkte test

VERKIRJGBARE CERTIFICATEN

- Technische product specificaties
- Test rapport UNI EN10204 type 2.2
- Inspectie certificaat UNI EN10204 type 3.1
- CE Conformiteits verklaring

ØxE	≈	WLL	€		
"	mm	kg			
3/8x6	M10X150	540	15,00	5	081100004
1/2x6	M12x150	1000	28,50	5	081100006
1/2x9	M12x230	1000	36,00	5	081100010
5/8x6	M16x150	1590	50,00	2	081100014
5/8x9	M16X230	1590	58,50	2	081100015
5/8x12	M16x300	1590	68,00	2	081100016
3/4x6	M20x150	2360	73,50	2	081100019
3/4x9	M20x230	2360	85,50	2	081100020
3/4x12	M20x300	2360	97,00	2	081100021
7/8X12	M22x300	3270	141,50	1	081100022
1x6	M24x150	4540	145,00	1	081100027
1x12	M24x300	4540	207,50	1	081100029
*1.1/4x12	M33x300	6900	346,00	1	081100034
*1.1/4x18	M33X460	6900	411,00	1	081100035
*1.1/4x24	M33X610	6900	360,00	1	081100036
*1.1/2x12	M39x300	9710	486,00	1	081100038
*1.1/2x18	M39x460	9710	550,00	1	081100039
*1.3/4x18	M45x460	12700	838,00	1	081100044

* Gaffel met veiligheidsbout en splitpen

Robur

Robur

SPANSCHROEVEN



Het originele ontwerp van de gevestigde spanschroeven van **Robur** is enorm populair onder Italiaanse ontwerpers en constructeurs, gebaseerd op nauwkeurige maattoleranties, sterkte waarden hoger dan modellen DIN 1480 en traceerbaarheid gegarandeerd door zowel de fabrikant als de carrosserieën. Eersteklas elektrolytisch verzinken, met uniforme afzettingen vrij van zeswaardig chroom, resulteert in een goede weersbestendigheid en een nette uitstraling van blootliggende structurele elementen.



8005Z

Spanschroef met 2 ogen, gegalvaniseerd

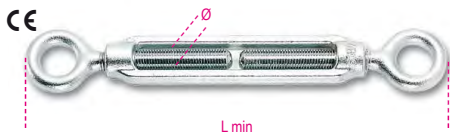

TECHNISCHE DATA

- Veiligheids factor: 4
- LABORATORIUM TEST
- Chemische analyse
- Treksterkte test
- VERKRIJGBARE CERTIFICATEN
- Technische product specificaties
- Test rapport UNI EN10204 type 2.2
- CE conformiteits verklaring

Ø mm	≈	L min mm	WFL kg	€	📦	🚚
M5	3/16	118	115	2,52	400	080050105
M6	1/4	130	160	2,93	300	080050106
M8	5/16	158	300	4,50	200	080050108
M10	3/8	192	470	6,45	100	080050110
M11	7/16	206	580	8,60	80	080050111
M12	1/2	226	690	9,60	60	080050112
M14	9/16	256	940	13,50	15	080050114
M16	5/8	290	1290	19,90	10	080050116
M18	11/16	358	1660	30,00	1	080050118
M20	3/4	358	2130	35,00	1	080050120
M22	7/8	400	2630	45,50	1	080050122
M24	1"	436	3060	57,00	1	080050124
M27	1 1/8	474	4000	81,00	1	080050125
M30	1 3/16	498	4860	98,00	1	080050130
M33	1 1/4	516	6040	112,50	1	080050126
M36	1 3/8	532	6500	141,50	1	080050136
M39	1 1/2	544	7900	168,00	1	080050139

Speciale verpakking



Ø mm	≈	📦	€	🚚
M5	3/16	30	85,00	1 080050705
M6	1/4	30	99,00	1 080050706
M8	5/16	20	101,00	1 080050708
M10	3/8	15	109,00	1 080050710
M11	7/16	15	145,00	1 080050711
M12	1/2	15	162,00	1 080050712

Speciale service verpakking



Ø mm	≈	€	📦	🚚
M5	2	6,00	1	080059305
M6	2	6,85	1	080059306
M8	1	5,70	1	080059108
M10	1	7,55	1	080059110
M11	1	9,75	1	080059111
M12	1	10,90	1	080059112
M14	1	14,00	1	080059114
M16	1	20,90	1	080059116

8005TZ

Spanschroef met twee ogen, gegalvaniseerd



TECHNISCHE DATA

- Veiligheids factor: 4
- LABORATORIUM TEST
- Chemische analyse
- Treksterkte test
- VERKRIJGBARE CERTIFICATEN
- Technische product specificaties
- Test rapport UNI EN10204 type 2.2
- CE conformiteits verklaring

Ø mm	≈	WFL kg	€	📦	🚚
M12	1/2	690	13,10	15	080050512
M16	5/8	1290	22,10	1	080050516
M20	3/4	2130	35,50	1	080050520
M24	1"	3060	59,50	1	080050524
M27	1 1/8	4000	80,00	1	080050527
M30	1 3/16	4860	93,50	1	080050530
M36	1 3/8	6500	152,50	1	080050536

Speciale service verpakking



Ø mm	≈	€	📦	🚚
M12	1	15,40	1	080059512



8006Z

Spanschroeven met oog en haak, gegalvaniseerd

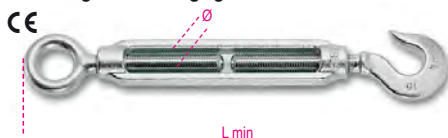

TECHNISCHE DATA

- Veiligheids factor: 4
- LABORATORIUM TEST
- Chemische analyse
- Treksterkte test
- VERKRIJGBARE CERTIFICATEN
- Technische product specificaties
- Test rapport UNI EN10204 type 2.2
- CE conformiteits verklaring

Ø mm	≈	L min mm	WFL kg	€	📦	🚚
M5	3/16	121	25	2,65	400	080060105
M6	1/4	132	45	2,93	250	080060106
M8	5/16	170	95	4,55	180	080060108
M10	3/8	204	140	6,60	100	080060110
M11	7/16	221	165	8,95	15	080060111
M12	1/2	244	300	10,30	15	080060112
M14	9/16	284	420	15,30	10	080060114
M16	5/8	322	570	22,80	1	080060116
M18	11/16	373	700	34,50	1	080060118
M20	3/4	391	900	40,00	1	080060120
M22	7/8	433	1100	52,00	1	080060122
M24	1"	470	1300	70,50	1	080060124
M27	1 1/8	503	2300	95,50	1	080060127

Speciale verpakking



Ø mm	≈	📦	€	🚚
M5	3/16	30	89,50	1 080060705
M6	1/4	30	99,00	1 080060706
M8	5/16	20	102,50	1 080060708
M10	3/8	15	111,50	1 080060710

Speciale service verpakking



Ø mm	≈	€	📦	🚚
M5	2	6,80	1	080069305
M6	2	7,65	1	080069306
M8	1	5,80	1	080069108
M10	1	7,95	1	080069110
M11	1	10,20	1	080069111
M12	1	11,50	1	080069112
M14	1	16,50	1	080069114

8007Z

Spanschroeven met 2 haken, gegalvaniseerd

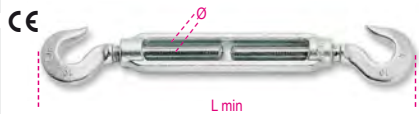

TECHNISCHE DATA

- Veiligheids factor: 4
- Identiteits code
- LABORATORIUM TEST
- Chemische analyse
- Treksterkte test
- VERKRIJGBARE CERTIFICATEN
- Technische product specificaties
- Test rapport UNI EN10204 type 2.2
- CE conformiteits verklaring

Ø mm	≈	L min mm	WFL kg	€		
M5	3/16	124	25	2,93	30	080070105
M6	1/4	134	45	3,30	30	080070106
M8	5/16	181	95	4,80	20	080070108
M10	3/8	211	140	7,00	15	080070110
M11	7/16	231	165	9,45	15	080070111
M12	1/2	262	300	11,30	15	080070112
M14	9/16	312	420	17,30	1	080070114
M16	5/8	354	570	26,00	1	080070116
M18	11/16	388	700	36,50	1	080070118
M20	3/4	424	900	46,00	1	080070120
M22	7/8	466	1100	58,00	1	080070122
M24	1"	504	1300	81,00	1	080070124
M27	1 1/8"	532	2300	106,00	1	080070127

Speciale service verpakking

Ø mm	≈	€		
M5	2	7,10	1	080079305
M6	2	7,65	1	080079306
M8	1	5,75	1	080079108
M10	1	7,80	1	080079110
M11	1	10,50	1	080079111
M12	1	12,40	1	080079112

8008N

Spanschroeven met dubbele aansluiting, zelfkleurend

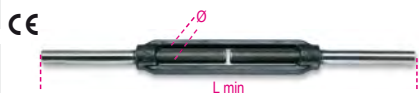

TECHNISCHE DATA

- Veiligheids coefficient: 4
- Identiteits code
- LABORATORIUM TEST
- Chemische analyse
- Treksterkte test
- VERKRIJGBARE CERTIFICATEN
- Technische product specificaties
- Test rapport UNI EN10204 type 2.2
- CE conformiteits verklaring

Ø mm	≈	L min mm	WFL kg	€		
M5	3/16	160	115	2,46	30	080080205
M6	1/4	180	160	2,52	30	080080206
M8	5/16	210	300	3,65	20	080080208
M10	3/8	250	470	5,15	15	080080210
M12	1/2	280	690	7,05	15	080080212
M14	9/16	340	940	10,20	5	080080214
M16	5/8	380	1290	14,00	5	080080216
M18	11/16	410	1660	21,30	3	080080218
M20	3/4	440	2130	24,80	3	080080220
M22	7/8	480	2630	34,50	2	080080222
M24	1"	520	3060	39,00	2	080080224
M27	1 1/8"	560	4000	63,00	1	080080227
M30	1 3/8"	560	4860	79,50	1	080080230
M33	1 1/4"	600	6040	85,50	1	080080233
M36	1 3/8"	600	6500	107,50	1	080080236
M39	1 1/2"	600	7900	124,00	1	080080239

Speciale service verpakking

Ø mm	≈	€		
M5	2	6,90	1	080089305
M6	2	7,00	1	080089306
M8	1	5,15	1	080089208
M10	1	6,80	1	080089210
M12	1	8,65	1	080089212
M14	1	12,00	1	080089214

8008TZN

Spanschroeven met dubbele aansluiting, pijp behuizing DIN 1478, zelfkleurende draad, gegalvaniseerde behuizing



TECHNISCHE DATA

- Veiligheids factor: 4
- LABORATORIUM TESTS
- Chemische analyse
- Treksterkte test
- VERKRIJGBARE CERTIFICATEN
- Product specificaties
- Test rapport type 2.2 UNI EN10204
- CE conformiteits verklaring

Ø mm	≈	WFL kg	€		
M12	1/2	690	9,60	10	080080512
M16	5/8	1290	17,30	1	080080516
M20	3/4	2130	26,00	1	080080520
M24	1	3060	43,00	1	080080524
M27	1.1/8	4000	65,50	1	080080527
M30	1.3/16	4860	75,00	1	080080530
M36	1.3/8	6500	122,00	1	080080536

8009Z

Spanschroeven met 2 gaffels, gegalvaniseerd

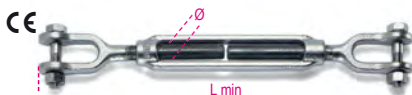

TECHNISCHE DATA

- Veiligheids coefficient: 4
- Identiteits code
- LABORATORIUM TEST
- Chemische analyse
- Treksterkte test
- VERKRIJGBARE CERTIFICATEN
- Technische product specificaties
- Test rapport UNI EN10204 type 2.2
- CE conformiteits verklaring

Ø mm	≈	L min mm	WFL kg	€		
M8	5/16	192	300	14,40	15	080090008
M10	3/8	234	470	17,20	15	080090010
M12	1/2	274	690	24,50	15	080090012
M14	9/16	342	940	35,00	1	080090014
M16	5/8	372	1290	40,50	1	080090016
M18	11/16	406	1660	58,00	1	080090018
M20	3/4	406	2130	61,50	1	080090020
M22	7/8	466	2630	83,50	1	080090022
M24	1"	486	3060	94,50	1	080090024
M27	1 1/8"	510	4000	146,50	1	080090027
M30	1 3/16"	566	4860	187,00	1	080090030

speciale pakken



Ø mm	≈	€		
M8	5/16	5	81,00	1 080090708
M10	3/8	5	96,50	1 080090710
M12	1/2	5	138,00	1 080090712

Speciale service verpakking

Ø mm	≈	€		
M8	1	16,00	1	080099008
M10	1	18,20	1	080099010
M12	1	24,50	1	080099012

8009TZ

Spanschroeven met dubbele gaffels, pijpbehuizing, DIN 1478 gegalvaniseerd



TECHNISCHE DATA

- Veiligheids coefficient: 4
- LABORATORIUM TESTEN
- Chemische analyse
- Treksterkte test
- VERKRIJGBARE CERTIFICATEN
- Technisch product specificaties
- Test rapport UNI EN10204 type 2.2
- CE conformiteits verklaring

Ø mm	≈	WFL kg	€		
M12	1/2	690	22,80	10	080090512
M16	5/8	1290	39,00	1	080090516
M20	3/4	2130	55,00	1	080090520
M24	1	3060	86,50	1	080090524
M27	1.1/8	4000	119,00	1	080090527
M30	1.3/16	4860	153,50	1	080090530

Speciale service verpakking

Ø mm	≈	€		
M12	1	25,50	1	080099512

Robur

8010Z

Spanschroeven met oog en gaffel, gegalvaniseerd



TECHNISCHE DATA

- Veiligheidscoëfficiënt: 4
- Identiteitscode
- LABORATORIUM TEST
- Chemische analyse
- Treksterkte test
- VERKRIJGBARE CERTIFICATEN
- Technische product specificaties
- Test rapport UNI EN10204 type 2.2
- CE conformiteitsverklaring

Ø mm	≈	L min mm	WFL kg	€		
M8	5/16	175	300	8,70	20	080100008
M10	3/8	215	470	11,00	15	080100010
M12	1/2	250	690	16,40	10	080100012
M14	9/16	299	940	22,50	10	080100014
M16	5/8	331	1290	29,50	1	080100016
M18	11/16	382	1660	45,00	1	080100018
M20	3/4	382	2130	49,00	1	080100020
M22	7/8	433	2630	66,00	1	080100022
M24	1"	461	3060	77,00	1	080100024
M27	1 1/8	492	4000	114,00	1	080100027
M30	1 3/16	529	4860	146,50	1	080100030

Speciale service verpakking



Ø mm		€		
M8	1	10,30	1	080109008
M10	1	12,80	1	080109010
M12	1	17,40	1	080109012
M14	1	24,50	1	080109014

8010TZ

Spanschroeven met oog en gaffel, pijp behuizing DIN 1478, gegalvaniseerd



TECHNISCHE DATA

- Veiligheids factor: 4
- LABORATORIUM TESTS
- Chemische analyse
- Treksterkte test
- VERKRIJGBARE CERTIFICATEN
- Product specificaties
- Test rapport type 2.2 UNI EN10204
- CE conformiteitsverklaring

Ø mm	≈	WFL kg	€		
M12	1/2	690	17,90	10	080100612
M16	5/8	1290	30,50	1	080100616
M20	3/4	2130	46,50	1	080100620
M24	1	3060	76,50	1	080100624
M27	1.1/8	4000	107,00	1	080100627
M30	1.3/16	4860	129,00	1	080100630

8011Z

haak- en kaakspanschroeven, verzinkt



TECHNISCHE DATA

- veiligheidsfactor: 4
- LABORATORIUM TESTEN
- chemische analyse
- trekproef
- BESCHIKBARE CERTIFICATEN
- Productspecificatie
- Testrapport UNI EN10204 type 2.2
- CE-conformiteitsverklaring

Ø mm	≈	L min mm	WFL kg	€		
M12	1/2	270	300	11,00	1	080110112
M16	5/8	360	570	21,50	1	080110116
M20	3/4	420	900	35,50	1	080110120
M24	1"	490	1300	60,00	1	080110124
M27	1 1/8	500	2300	83,00	1	080110127

8011TZ

haak- en kaakspanschroeven, pijplichamen DIN 1478, verzinkt



TECHNISCHE DATA

- veiligheidsfactor: 4
- LABORATORIUM TESTEN
- chemische analyse
- trekproef
- BESCHIKBARE CERTIFICATEN
- Productspecificatie
- Testrapport UNI EN10204 type 2.2
- CE-conformiteitsverklaring

Ø mm	≈	L min mm	WFL kg	€		
M12	1/2	260	300	12,50	1	080110612
M16	5/8	350	570	23,50	1	080110616
M20	3/4	400	900	35,00	1	080110620
M24	1"	490	1300	60,00	1	080110624
M27	1 1/8	500	2300	79,00	1	080110627

8001Z

Spanschroefhuizen gegalvaniseerd



TECHNISCHE DATA

- Veiligheids factor: 4
- Identiteitscode
- LABORATORIUM TEST
- Chemische analyse
- Treksterkte test
- VERKRIJGBARE CERTIFICATEN
- Technische product specificaties
- Test rapport UNI EN10204 type 2.2
- CE conformiteitsverklaring

Ø mm	≈	L mm	WFL kg	€		
M5	3/16	80	115	1,54	100	080010105
M6	1/4	80	160	1,61	100	080010106
M8	5/16	105	300	2,52	25	080010108
M10	3/8	125	470	3,30	20	080010110
M11	7/16	135	580	4,00	15	080010111
M12	1/2	140	690	4,35	20	080010112
M14	9/16	170	940	6,05	15	080010114
M16	5/8	190	1290	8,25	15	080010116
M18	11/16	205	1660	13,10	10	080010118

Ø mm	≈	L mm	WFL kg	€		
M20	3/4	220	2130	15,20	10	080010120
M22	7/8	240	2630	19,20	8	080010122
M24	1"	260	3060	23,40	5	080010124
M27	1 1/8	270	4000	37,00	1	080010127
M30	1 3/16	280	4860	46,50	1	080010130
M33	1 1/4	290	6040	51,00	1	080010133
M36	1 3/8	300	6500	65,50	1	080010136
M39	1 1/2	300	7900	78,00	1	080010139

Speciale service verpakking



Ø mm		€		
M5	2	4,65	1	080019305
M6	2	5,05	1	080019306
M8	1	4,00	1	080019108
M10	1	4,70	1	080019110
M11	1	5,65	1	080019111
M12	1	5,85	1	080019112
M14	1	7,80	1	080019114
M16	1	9,90	1	080019116
M18	1	14,60	1	080019118
M20	1	16,50	1	080019120
M22	1	20,80	1	080019122
M24	1	24,90	1	080019124

8001TZ

Spanschroefhuizen, gegalvaniseerd



DIN 1478

TECHNISCHE DATA

- Veiligheids factor: 4
- Identificatiecode
- LABORATORIUM TEST
- Chemische analyse
- Treksterkte test
- VERKRIJGBARE CERTIFICATEN
- Technische product specificaties
- Test rapport UNI EN10204 type 2.2
- CE conformiteitsverklaring

Ø mm	≈	L mm	WFL kg	€		
M12	1/2	125	690	7,10	10	080010512
M16	5/8	170	1290	10,90	5	080010516
M20	3/4	200	2130	14,30	5	080010520
M24	1	255	3060	25,50	3	080010524
M27	1.1/8	255	4000	34,50	1	080010527
M30	1.3/16	255	4860	38,50	1	080010530
M36	1.3/8	295	6500	69,00	1	080010536
M42	1.5/8	330	9700	97,50	1	080010542

Speciale service verpakking



Ø mm		€		
M12	1	8,60	1	080019512
M16	1	12,00	1	080019516
M20	1	15,70	1	080019520
M24	1	26,50	1	080019524

8002ZD

Ogen voor spanschroef rechtse draad, gegalvaniseerd

Op verzoek leverbaar met linkse draad



TECHNISCHE DATA

- Veiligheids factor: 4
- Identiteits code

LABORATORIUM TEST

- Chemische analyse
- Treksterkte test

VERKRIJGBARE CERTIFICATEN

- Technische product specificaties
- Test rapport UNI EN10204 type 2.2

Ø mm	≈ "	E mm	WFL kg	€	📦	🚚
M5	3/16	37	115	0,54	200	080020105
M6	1/4	40	160	0,66	150	080020106
M8	5/16	52	300	0,96	100	080020108
M10	3/8	60	470	1,54	100	080020110
M11	7/16	65	580	2,18	1	080020111
M12	1/2	72	690	2,71	50	080020112
M14	9/16	85	940	3,40	1	080020114
M16	5/8	95	1290	5,65	1	080020116
M18	11/16	103	1660	8,25	1	080020118
M20	3/4	110	2130	9,25	1	080020120
M22	7/8	120	2630	13,50	1	080020122
M24	1"	130	3060	17,20	1	080020124
M27	1 1/8	135	4000	23,60	1	080020127
M30	1 3/16	140	4860	27,50	1	080020130
M33	1 1/4	148	6040	34,00	1	080020133
M36	1 3/8	150	6500	40,50	1	080020198
M39	1 1/2	150	7900	47,50	1	080020199

Ø mm	≈ "	E mm	WFL kg	€	📦	🚚
M5	3/16	37	115	0,54	1	080020305
M6	1/4	40	160	0,66	1	080020306
M8	5/16	52	300	0,96	1	080020308
M10	3/8	60	470	1,54	1	080020310
M11	7/16	65	580	2,18	1	080020311
M12	1/2	72	690	2,71	1	080020312
M14	9/16	85	940	3,40	1	080020314
M16	5/8	95	1290	5,65	1	080020316
M18	11/16	103	1660	8,25	1	080020318
M20	3/4	110	2130	9,25	1	080020320
M22	7/8	120	2630	13,50	1	080020322
M24	1"	130	3060	17,20	1	080020324
M27	1 1/8	135	4000	23,60	1	080020327
M30	1 3/16	140	4860	27,50	1	080020330
M33	1 1/4	148	6040	34,00	1	080020333
M36	1 3/8	150	6500	40,50	1	080020398
M39	1 1/2	150	7900	47,50	1	080020399



Robur

8003ZD

Haken voor spanschroef rechtse draad, gegalvaniseerd

Op verzoek leverbaar met linkse draad



TECHNISCHE DATA

- Veiligheids factor: 4
- LABORATORIUM TEST

- Chemische analyse
- Treksterkte test

VERKRIJGBARE CERTIFICATEN

- Technische product specificaties
- Test rapport UNI EN10204 type 2.2

Ø mm	≈ "	E mm	WFL kg	€	📦	🚚
M5	3/16	40	25	0,71	150	080030105
M6	1/4	40	45	0,80	120	080030106
M8	5/16	52	95	1,19	100	080030108
M10	3/8	60	140	2,10	70	080030110
M11	7/16	65	165	2,87	1	080030111
M12	1/2	70	300	3,70	30	080030112
M14	9/16	85	420	5,65	1	080030114
M16	5/8	95	570	8,40	1	080030116
M18	11/16	103	700	11,30	1	080030118
M20	3/4	110	900	15,40	1	080030120
M22	7/8	120	1100	19,90	1	080030122
M24	1"	130	1300	30,00	1	080030124
M27	1 1/8	135	2300	36,50	1	080030127

Ø mm	≈ "	WFL kg	E mm	€	📦	🚚
M5	3/16	40	25	0,71	1	080030305
M6	1/4	40	45	0,80	1	080030306
M8	5/16	52	95	1,19	1	080030308
M10	3/8	60	140	2,10	1	080030310
M11	7/16	65	165	2,87	1	080030311
M12	1/2	70	300	3,70	1	080030312
M14	9/16	85	420	5,65	1	080030314
M16	5/8	95	570	8,40	1	080030316
M18	11/16	103	700	11,30	1	080030318
M20	3/4	110	900	15,40	1	080030320
M22	7/8	120	1100	19,90	1	080030322
M24	1"	130	1300	30,00	1	080030324
M27	1 1/8	135	2300	36,50	1	080030327

8004ND

Spanschroefhuis, rechtse draad, zelfkleurend

Linkse draad op verzoek leverbaar



TECHNISCHE DATA

- Veiligheids factor: 4
- LABORATORIUM TEST

- Chemische analyse
- Treksterkte test

VERKRIJGBARE CERTIFICATEN

- Technische product specificaties
- Test rapport UNI EN10204 type 2.2

Ø mm	≈ "	E mm	WFL kg	€	📦	🚚
M5	3/16	40	115	0,56	1	080040005
M6	1/4	44	160	0,66	1	080040006
M8	5/16	53	300	0,77	1	080040008
M10	3/8	63	470	1,14	1	080040010
M12	1/2	70	690	1,88	1	080040012
M14	9/16	85	940	2,59	1	080040014
M16	5/8	95	1290	3,60	1	080040016
M18	11/16	103	1660	4,85	1	080040018
M20	3/4	110	2130	6,05	1	080040020
M22	7/8	120	2630	7,55	1	080040022
M24	1"	130	3060	10,70	1	080040024
M27	1 1/8	135	4000	17,10	1	080040027
M30	1 3/16	140	4860	21,00	1	080040030
M33	1 1/4	150	6040	21,70	1	080040033
M36	1 3/8	150	6500	28,50	1	080040098
M39	1 1/2	150	7900	30,50	1	080040099

Ø mm	≈ "	E mm	WFL kg	€	📦	🚚
M5	3/16	40	115	0,56	1	080040105
M6	1/4	44	160	0,66	1	080040106
M8	5/16	53	300	0,77	1	080040108
M10	3/8	63	470	1,14	1	080040110
M12	1/2	70	690	1,88	1	080040112
M14	9/16	85	940	2,59	1	080040114
M16	5/8	95	1290	3,60	1	080040116
M18	11/16	103	1660	4,85	1	080040118
M20	3/4	110	2130	6,05	1	080040120
M22	7/8	120	2630	7,55	1	080040122
M24	1"	130	3060	10,70	1	080040124
M27	1 1/8	135	4000	17,10	1	080040127
M30	1 3/16	140	4860	21,00	1	080040130
M33	1 1/4	150	6040	21,70	1	080040133
M36	1 3/8	150	6500	28,50	1	080040198
M39	1 1/2	150	7900	30,50	1	080040199

Robur

Robur

8009FD

Gaffelseindstuk, rechtse draad, gegalvaniseerd

Linkse draad op verzoek leverbaar

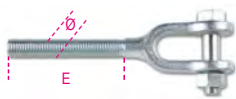

TECHNISCHE DATA

- Veiligheids factor: 4
- LABORATORIUM TEST
- Chemische analyse
- Treksterkte test

VERKRIJGBARE CERTIFICATEN

- Technische product specificaties
- Test rapport UNI EN10204 type 2.2

Ø mm	≈ mm	E mm	WFL kg	€		
M8	5/16	53	300	5,95	1	080090208
M10	3/8	63	470	7,00	1	080090210
M12	1/2	70	690	9,45	1	080090212
M14	9/16	85	940	13,10	1	080090214
M16	5/8	95	1290	14,90	1	080090216
M18	11/16	103	1660	21,00	1	080090218
M20	3/4	110	2130	21,70	1	080090220
M22	7/8	120	2630	30,50	1	080090222
M24	1"	130	3060	36,00	1	080090224
M27	1 1/8	135	4000	56,00	1	080090227
M30	1 3/16	140	4860	72,00	1	080090230

gaffels voor voor spanschroeven rechtshandig - gegalvaniseerd

Ø mm	≈ mm	WFL kg	G mm	€		
M8	5/16	53	300	5,95	1	080090408
M10	3/8	63	470	7,00	1	080090410
M12	1/2	70	690	9,45	1	080090412
M14	9/16	85	940	13,10	1	080090414
M16	5/8	95	1290	14,90	1	080090416
M18	11/16	103	1660	21,00	1	080090418
M20	3/4	110	2130	21,70	1	080090420
M22	7/8	120	2630	30,50	1	080090422
M24	1"	130	3060	36,00	1	080090424
M27	1 1/8	135	4000	56,00	1	080090427
M30	1 3/16	140	4860	72,00	1	080090430

8048

Oogstelschroeven rechtse draad zelfkleurend



UNI 6058

ØxL mm	WFL kg	F mm	E mm	€		
M8x50	430	6	39	3,75	20	080480108
M8x65	430	6	54	4,00	20	080480109
M10x80	690	8	66	6,20	10	080480110
M10x100	690	8	86	6,20	10	080480210
M10x130	690	8	116	7,00	10	080480111
M12x70	1020	10	53	6,45	8	080480212
M12x95	1020	10	78	6,60	8	080480112
M12x125	1020	10	108	8,10	8	080480113
M14x110	1420	12	91	9,10	6	080480114
M16x100	1980	14	79	7,55	6	080480115
M16x130	1980	14	109	7,80	6	080480116
M18x150	2390	16	126	17,60	2	080480118
M20x160	3100	18	134	21,70	2	080480120
M22x180	3890	18	152	34,50	1	080480122
M24x200	4460	20	168	39,00	1	080480124
M24x220	4460	20	188	41,50	1	080480125
M27x220	5900	22	185	50,50	1	080480127

8302Z

Oogstelschroeven rechtse draad gegalvaniseerd

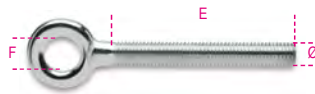

TECHNISCHE DATA

- Veiligheids factor: 4
- VERKRIJGBARE CERTIFICATEN
- Technische product specificaties
- Test rapport UNI EN10204 type 2.2

Ø mm	E mm	F mm	WFL kg	€		
M5	48	8	115	0,60	200	083020005
M6	55	10	160	0,73	150	083020006
M8	60	12	300	0,98	100	083020008
M10	73	14	470	1,67	100	083020010
M12	90	17	690	3,30	50	083020012

speciale pakken



Ø mm	E mm	WFL kg	€		
M5	48	100	67,50	1	083020705
M6	55	75	61,50	1	083020706
M8	60	50	55,00	1	083020708
M10	73	50	94,00	1	083020710
M12	90	25	93,00	1	083020712

8303Z

Haakstelschroeven rechtse draad, gegalvaniseerd



TECHNISCHE DATA

- Veiligheids factor: 4
- VERKRIJGBARE CERTIFICATEN
- Technische product specificaties
- Test rapport UNI EN10204 type 2.2

Ø mm	C mm	E mm	WFL kg	€		
M5	6,0	48	25	0,71	120	083030005
M6	8,0	55	45	0,77	100	083030006
M8	10,0	60	95	1,25	75	083030008
M10	12,5	73	140	2,10	50	083030010
M12	16,0	90	220	3,55	20	083030012

speciale pakken



Ø mm	C mm	WFL kg	€		
M5	6,0	60	48,00	1	083030705
M6	8,0	50	43,50	1	083030706
M8	10,0	30	42,00	1	083030708
M10	12,5	25	59,00	1	083030710
M12	16,0	10	40,00	1	083030712

8702N - 8702Z - 8702ZC

Anwalsoog van gesmeed staal

gesloten zwart



TECHNISCHE DATA

- Identificatie code
- LABORATORIUM TEST
- Chemische analyse
- Treksterkte test
- VERKRIJGBARE CERTIFICATEN
- Technische product specificaties
- Test rapport UNI EN10204 type 2.2
- Inspectie certificaat UNI EN10204 type 3.1

M	Ø B mm	Ø A mm	Ø D mm	€		
6	6,8	13	19	50,50	1	087020106
8	8,8	20	22	60,50	1	087020108
9	9,8	20	22	60,50	1	087020109
10	10,8	20	22	60,50	1	087020110
11	11,8	25	27	75,00	1	087020111
12	12,8	25	27	75,00	1	087020112
13	13,8	25	27	75,00	1	087020113
14	14,8	32	32	104,00	1	087020114
15	15,9	32	32	104,00	1	087020115
16	17,0	32	32	104,00	1	087020116
18	19,0	39	37	134,50	1	087020118
19	20,0	39	37	134,50	1	087020119
20	21,1	39	37	134,50	1	087020120
22	23,2	43	43	187,00	1	087020122
24	25,4	50	52	216,00	1	087020124
25	26,4	50	52	216,00	1	087020125
26	27,4	50	52	216,00	1	087020126

Het walsen van de terminals vereist geschikte personen en matrijzen en kan alleen worden uitgevoerd door geschoold personeel.

8702Z gegalvaniseerd

M	Ø B mm	Ø A mm	Ø D mm	€		
6	6,8	13	19	52,50	1	087020306
8	8,8	20	22	64,00	1	087020308
9	9,8	20	22	64,00	1	087020309
10	10,8	20	22	64,00	1	087020310
11	11,8	25	27	78,00	1	087020311
12	12,8	25	27	78,00	1	087020312
13	13,8	25	27	78,00	1	087020313
14	14,8	32	32	109,50	1	087020314
15	15,9	32	32	109,50	1	087020315
16	17,0	32	32	109,50	1	087020316
18	19,0	39	37	141,50	1	087020318
19	20,0	39	37	141,50	1	087020319
20	21,1	39	37	141,50	1	087020320
22	23,2	43	43	194,00	1	087020322
24	25,4	50	52	225,50	1	087020324
25	26,4	50	52	225,50	1	087020325
26	27,4	50	52	225,50	1	087020326

8702ZC thermisch verzinkt

M	Ø B mm	Ø A mm	Ø D mm	€		
6	6,8	13	19	56,00	1	087020206
8	8,8	20	22	69,00	1	087020208
9	9,8	20	22	69,00	1	087020209
10	10,8	20	22	69,00	1	087020210
11	11,8	25	27	86,00	1	087020211
12	12,8	25	27	86,00	1	087020212
13	13,8	25	27	86,00	1	087020213
14	14,8	32	32	126,00	1	087020214
15	15,9	32	32	126,00	1	087020215
16	17,0	32	32	126,00	1	087020216
18	19,0	39	37	163,00	1	087020218
19	20,0	39	37	163,00	1	087020219
20	21,1	39	37	163,00	1	087020220
22	23,2	43	43	221,50	1	087020222
24	25,4	50	52	259,00	1	087020224
25	26,4	50	52	259,00	1	087020225
26	27,4	50	52	259,00	1	087020226

8709N - 8709Z - 8709ZC

Aanwalsgaffel van gesmeed staal

open
zwart



TECHNISCHE DATA

• Identificatie code
LABORATORIUM TEST

• Chemische analyse
• Treksterkte test

VERKRIJGBARE CERTIFICATEN

• Technische product specificaties
• Test rapport UNI EN10204 type 2.2
• Inspectie certificaat UNI EN10204 type 3.1

M	ø B mm	ø A mm	ø C mm	€		
6	6,8	13	17	69,00	1	087090106
8	8,8	20	21	89,50	1	087090108
9	9,8	20	21	89,50	1	087090109
10	10,8	20	21	89,50	1	087090110
11	11,8	25	25	111,50	1	087090111
12	12,8	25	25	111,50	1	087090112
13	13,8	25	25	111,50	1	087090113
14	14,8	32	30	155,50	1	087090114
15	15,9	32	30	155,50	1	087090115
16	17,0	32	30	155,50	1	087090116
18	19,0	39	35	202,00	1	087090118
19	20,0	39	35	202,00	1	087090119
20	21,1	39	35	202,00	1	087090120
22	23,2	43	41	258,00	1	087090122
24	25,4	50	51	265,00	1	087090124
25	26,4	50	51	265,00	1	087090125
26	27,4	50	51	265,00	1	087090126

Het walsen van de terminals vereist geschikte persen en matrijzen en kan alleen worden uitgevoerd door geschoold personeel.

8709Z gegalvaniseerd

M	ø B mm	ø A mm	ø C mm	€		
6	6,8	13	17	71,00	1	087090306
8	8,8	20	21	93,50	1	087090308
9	9,8	20	21	93,50	1	087090309
10	10,8	20	21	93,50	1	087090310
11	11,8	25	25	116,50	1	087090311
12	12,8	25	25	116,50	1	087090312
13	13,8	25	25	116,50	1	087090313
14	14,8	32	30	163,00	1	087090314
15	15,9	32	30	163,00	1	087090315
16	17,0	32	30	163,00	1	087090316
18	19,0	39	35	211,50	1	087090318
19	20,0	39	35	211,50	1	087090319
20	21,0	39	35	211,50	1	087090320
22	23,2	43	41	278,00	1	087090322
24	25,4	50	51	278,00	1	087090324
25	26,4	50	51	278,00	1	087090325
26	27,4	50	51	278,00	1	087090326

8709ZC thermisch verzinkt

M	ø B mm	ø A mm	ø C mm	€		
6	6,8	13	17	73,50	1	087090206
8	8,8	20	21	98,50	1	087090208
9	9,8	20	21	98,50	1	087090209
10	10,8	20	21	98,50	1	087090210
11	11,8	25	25	127,00	1	087090211
12	12,8	25	25	127,00	1	087090212
13	13,8	25	25	127,00	1	087090213
14	14,8	32	30	184,00	1	087090214
15	15,9	32	30	184,00	1	087090215
16	17,0	32	30	184,00	1	087090216
18	19,0	39	35	234,50	1	087090218
19	20,0	39	35	234,50	1	087090219
20	21,1	39	35	234,50	1	087090220
22	23,2	43	41	300,00	1	087090222
24	25,4	50	51	329,00	1	087090224
25	26,4	50	51	329,00	1	087090225
26	27,4	50	51	329,00	1	087090226

STAALKABELKLEMMEN



Professionele staalkabelklemmen maken het mogelijk om sleuven te verkrijgen in staalkabels met stalen kernen, voor gebruik met sjor- en spansystemen. In tegenstelling tot veel in de handel verkrijgbare producten hebben onze staalkabelklemmen GEEN gietijzeren behuizing.

Om optimale mechanische prestaties bij zware klussen te garanderen, zijn de basissen warm gesmeed en zijn ze gemiddeld zwaarder dan vergelijkbare items.

Eersteklas elektrolytisch verzinken, vrij van zeswaardig chroom, zorgt voor een goede corrosieweerstand en verbetert het uiterlijk.

Gedurende de tientallen jaren van de geschiedenis van het bedrijf hebben al deze kenmerken artikel 8016 tot het icoon van het merk Robur gemaakt, waardoor staalkabelklemmen in 'Italiaanse stijl' wereldwijd opvallen.

8015

staalkabelklemmen, Amerikaans type, stalen lichaam, thermisch verzinkt

CE

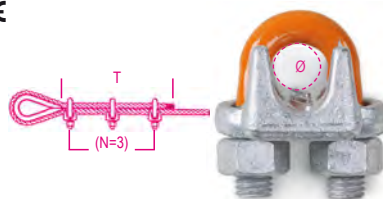

dimensioni EN 13411-5 tipo B

TECHNISCHE GEGEVENS

• traceerbaarheidscode
LABORATORIUM TESTS

• chemische analyse
• koppelttest

BESCHIKBARE CERTIFICATEN

• Technische productspecificaties
• Testrapport UNI EN10204 type 2.2
• Fabriekscertificaat UNI EN13411-5
• CE-Certificaat

ø mm	ø "	NxT	Nm	€		
8	5/16	3x133	40,7	2,52	12	080150808
10	3/8	3x165	61	3,55	12	080150810
13	1/2	3x292	88	5,45	6	080150813
16	5/8	3x305	129	7,70	6	080150816
20	3/4	4x460	176	10,50	6	080150820
22	7/8	4x480	305	16,70	6	080150822
26	1	5x660	305	18,20	5	080150826
30	1-1/8	6x860	305	19,50	2	080150830

8016

Staaldraadklemmen vervaardigd uit staal gegalvaniseerd

CE

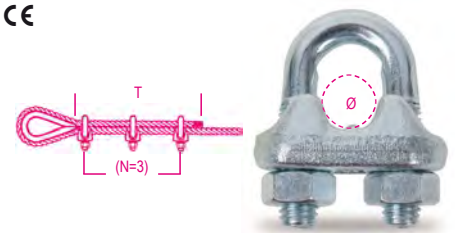

TECHNISCHE DATA

• Chemische analyse
• Treksterkte test

VERKRIJGBARE CERTIFICATEN

• Technische product specificaties
• Test rapport UNI EN10204 type 2.2
• CE conformiteits verklaring

ø mm	ø "	N x T	Nm	€		
3	1/8	3x80	1,53	0,69	500	080160003
5	3/16	3x110	3,02	0,87	300	080160005
6	1/4	3x120	5,19	0,96	200	080160006
8	5/16	5x210	5,19	1,19	150	080160008
10	3/8	5x240	12,54	1,78	70	080160010
11	7/16	5x260	12,54	1,92	70	080160011
12-13	1/2	5x300	24,76	2,57	40	080160013
14	9/16	5x295	24,76	2,79	35	080160014
16	5/8	5x335	24,76	3,35	30	080160016
18	11/16	5x380	42,42	4,50	30	080160018
20	3/4	5x540	42,42	4,85	30	080160020
22	7/8	7x595	42,42	5,65	25	080160022
24-26	1"	7x700	67,56	7,80	15	080160026
28	1"1/16	8x840	67,56	9,70	5	080160028
30-32	1"1/8	8x990	67,56	9,75	5	080160030
34-36	1"1/4	8x1155	105,80	12,90	4	080160034
38-40	1"1/2	8x1320	105,80	17,40	2	080160040
45-50	2"	8x1500	206	26,50	1	080160050

Speciale verpakking



ø mm	ø "	N x T	Nm	€		
3	1/8	100		77,50	1	080160703
5	3/16	50		49,00	1	080160705
6	1/4	50		54,00	1	080160706
8	5/16	30		40,00	1	080160708
10	3/8	30		60,00	1	080160710
11	7/16	25		54,00	1	080160711
12-13	1/2	15		43,50	1	080160713

Speciale service verpakking



ø mm		€		
3	6	5,10	1	080169403
5	4	4,55	1	080169405
6	4	5,05	1	080169406
8	4	5,85	1	080169408
10	2	4,70	1	080169410
11	1	3,45	1	080169011
12-13	1	4,00	1	080169013
14	1	4,20	1	080169014
16	1	4,70	1	080169016
18	1	5,95	1	080169018
20	1	6,05	1	080169020
22	1	7,10	1	080169022
24-26	1	9,35	1	080169026

8016FR

Staaldraadklemmen, vervaardigd uit gegalvaniseerd staal met doorgezet huis

CE

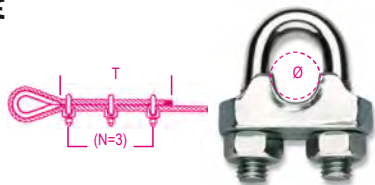

LABORATORIUM TEST

- chemische analyse
- VERKRIJGBARE CERTIFICATEN
- Technische product specificaties
- Test rapport UNI EN10204 type 2.2
- CE conformiteits verklaring

Ø mm	Ø mm	N x T	Nm	€		
3	1/8	3x80	1,25	0,63	500	080160253
5	3/16	3x110	2,46	0,75	300	080160255
6	1/4	3x120	4,24	0,91	200	080160256
8	5/16	5x210	4,24	1,05	150	080160258

8018E

Staaldraadklem gegalvaniseerd



LABORATORIUM TEST

- chemische analyse
- VERKRIJGBARE CERTIFICATEN
- Technische product specificaties
- Test rapport UNI EN10204 type 2.2

Ø mm	A mm	L mm	Nm	€		
4÷6	M6	34	4,24	1,38	100	080180001

Robur

8016U2

Staaldraadklemmen

CE

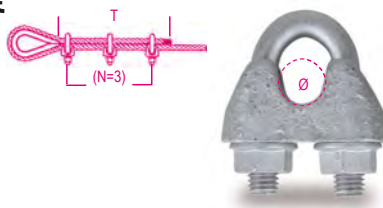

dimensioni EN 13411-5 tipo A

Ø mm	Ø mm	N x T	Nm	€		
5	3/16	3x156	2,0	0,37	300	080160855
6,5	1/4	3x192	3,5	0,50	150	080160856
8	5/16	4x320	6	1,02	70	080160858
10	3/8	4x320	9	1,07	60	080160860
12	1/2	4x384	20	2,02	25	080160862
14	9/16	4x448	33	3,15	15	080160864
16	5/8	4x512	49	4,70	10	080160866
19	3/4	4x512	68	5,45	10	080160869
22	7/8	5x680	107	7,80	10	080160872
26	1	5x760	147	14,00	5	080160876
30	1.1/8	6x984	212	18,00	5	080160880
34	1.1/4	6x1080	296	24,60	5	080160884
40	1.1/2	6x1176	363	30,00	5	080160890

Speciale service verpakking



Ø mm		€		
5	4	4,50	1	080169805
6	4	5,65	1	080169806
8	4	8,70	1	080169808
10	2	5,85	1	080169810
12	1	5,65	1	080169612
14	1	6,45	1	080169614
16	1	8,70	1	080169616
19	1	9,45	1	080169619
22	1	12,30	1	080169622
26	1	20,20	1	080169626

8016UGK

Staaldraadklemmen, vervaardigd uit smeedbaar gietijzer, HOT DIP GEGALVANISEERDE behuizing, GEOMET-GEOKOTE U-bouten en moeren

CE

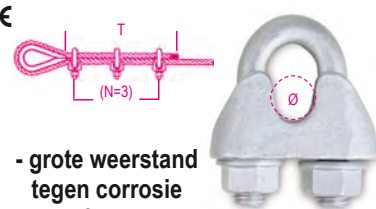

- grote weerstand tegen corrosie
- Identificatie code

dimensioni EN 13411-5 tipo A

TECHNISCHE DATA

- Identificatie code
- LABORATORIUM TEST
- Chemische analyse
- Torque test
- VERKRIJGBARE CERTIFICATEN
- Technische product specificaties
- Test rapport UNI EN10204 type 2.2
- Fabrikanten Certificaat UNI EN13411-5
- CE conformiteits verklaring

Ø mm	Ø mm	N x T	Nm	€		
8	5/16	4x320	6	2,02	70	080160758
10	3/8	4x320	9	2,24	60	080160760
12	1/2	4x448	33	4,00	25	080160762
14	9/16	4x384	20	5,85	15	080160764
16	5/8	4x512	49	8,70	10	080160766
19	3/4	4x512	68	9,75	10	080160769
22	7/8	5x680	107	14,00	10	080160772
26	1	5x760	147	22,90	5	080160776
30	1.1/8	6x984	212	27,50	1	080160780
34	1.1/4	6x1080	296	39,50	1	080160784
40	1.1/2	6x1176	363	49,00	1	080160790

8018T

Staaldraadklem gegalvaniseerd



RUM-MU-21:1980

LABORATORIUM TEST

- chemische analyse
- VERKRIJGBARE CERTIFICATEN
- Technische product specificaties
- Test rapport UNI EN10204 type 2.2

Ø mm	A mm	L mm	Nm	€		
8÷10	M8	42	10,20	1,41	200	080180003

Robur

Robur

8020A

Puntkousen, Italiaans, lichte uitvoering, gegalvaniseerd

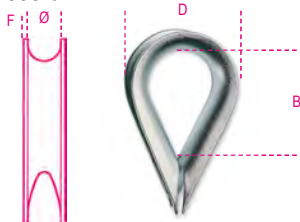

VERKRIJGBARE CERTIFICATEN

- Technische product specificaties
- Test rapport UNI EN10204 type 2.2

Ø mm	F mm	B mm	D mm	€	📦	🚚
2-3	1,0	20	18	0,26	150	080200503
4	1,2	23	19	0,27	150	080200504
5	1,2	24	23	0,31	100	080200505
6	1,2	27	28	0,32	100	080200506
8	1,4	33	32	0,50	50	080200508
10	1,8	41	38	0,74	30	080200510
12	2,2	44	45	0,97	30	080200512
14	2,2	52	49	1,25	50	080200514
16	3,0	58	58	1,75	50	080200516
18	3,7	64	68	2,46	50	080200518
20	3,7	73	74	3,15	35	080200520
22	3,7	83	79	3,60	30	080200522
24	3,7	93	88	4,70	20	080200525

Speciale verpakking



Ø mm	S mm	📦	€	📦	🚚
2-3	0,8	150	39,00	1	080200703
4	1,0	150	40,50	1	080200704
5	1,0	100	31,00	1	080200705
6	1,0	100	32,00	1	080200706
8	1,2	50	25,00	1	080200708
10	1,5	30	22,20	1	080200710

8021A

Puntkousen, zware uitvoering, gegalvaniseerd

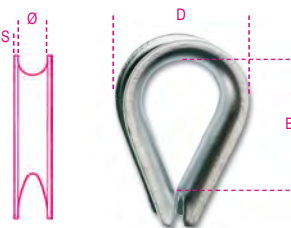

VERKRIJGBARE CERTIFICATEN

- Technische product specificaties
- Test rapport UNI EN10204 type 2.2

Ø mm	S mm	B mm	D mm	€	📦	🚚
2-3	0,6	15	16	0,41	150	080210103
5	1,7	29	28	0,60	120	080210105
6	1,8	33	30	0,67	100	080210106
8	2,5	36	37	0,90	100	080210108
10	2,5	42	43	1,10	80	080210110
12	2,5	48	50	1,41	100	080210112
14	2,7	58	57	1,88	70	080210114
16	3	61	62	2,30	50	080210116
18	3,5	71	71	3,00	70	080210118
20	4	79	79	4,50	30	080210120
22	4	87	84	5,15	25	080210122
24	4	93	92	6,05	25	080210124
26	4	103	103	7,55	20	080210126
28	5	107	116	17,60	1	080210128
30	5	118	121	17,60	1	080210130
32	5,5	138	135	21,00	1	080210132
35	6	140	147	29,00	1	080210135
40	6,0	174	170	41,50	1	080210140

BEUGELS



In tegenstelling tot vergelijkbare producten zijn de robuuste beugels van Robur volledig gemaakt van gehard en getemperd chroom-molybdeen gelegeerd staal en ontworpen om in laboratoriumtests meer dan 20.000 volledige belastingscycli te doorstaan. Daarom vallen ze op in hun categorie, als de beste optie voor zwaar werk, met een veiligheidsfactor die de eisen van de referentienormen overtreft (6:1 in plaats van 5:1) en uitstekende veerkracht bij lage temperaturen.

De zachtstalen beugels van Robur staan synoniem voor betrouwbaarheid en effectiviteit in de tijd, gebaseerd op grondstoffen van topkwaliteit, uitstekende mechanische afwerking en warmtebehandeling (normaliseren), waardoor een hoge werklast en veiligheidsfactor kan worden bereikt in vergelijking met die van vergelijkbare in de handel verkrijgbare producten.

Een duidelijke, onuitwisbare markering op elk stuk maakt het mogelijk om de oorsprong van de sluiting te identificeren, b.v. bij inspecties door auditbedrijven of bevoegde instanties.

8026R

Harpsluitingen voor hef werkzaamheden, staal met hoge treksterkte, veiligheidsbout. Gegloeid en gegalvaniseerd.

CE

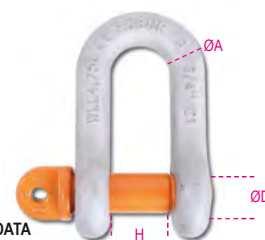

EN 13889

TECHNICAL DATA

- Minimale veiligheidsfactor: 6
 - Hittebehandeling; gehard en getemperd
 - Identificatiecode zowel op de pin en op de sluiting
- LABORATORIUM TESTEN
- Chemische analyse • Metaalgrafische analyse
 - Treksterkte test • Vermoeidheids test (min. 20,000 cycli)
 - Limiet belastings test (2 x WLL)

VERKRIJGBARE CERTIFICATEN

- Technische product specificaties
- Test rapport UNI EN10204 type 2.2
- Inspectie certificaat UNI EN10204 type 3.1

CE conformiteits verklaring

ØD mm	ØA mm	H mm	WLL kg	€	📦	🚚
11	10	17	1000	6,80	5	080260210
16	13	21	2000	12,60	5	080260212
19	16	27	3250	21,40	3	080260216
22	19	32	4750	30,50	2	080260219
25	22	37	6500	47,50	2	080260222

Speciale service verpakking



ØD mm	📦	€	📦	🚚
16	1	13,80	1	080269212
19	1	22,90	1	080269216

8029R

Harpsluitingen voor hef werkzaamheden, staal met hoge treksterkte, borstbout. Gegloeid en gegalvaniseerd.

CE



EN 13889

TECHNICAL DATA

- minimum safety factor: 6
- heat treatment: hardening and tempering
- traceability code on pin and body

LABORATORY TESTS

- chemical analysis
- metallographic analysis
- tensile test
- fatigue test (min. 20,000 cycles)
- proof load test (2 x WLL)

AVAILABLE CERTIFICATES

- Technical Product Specifications
- Test Report UNI EN10204 type 2.2
- Inspection Certificate UNI EN10204 type 3.1
- CE Declaration of Conformity

ØD mm	ØA mm	H mm	WLL kg	€	📦	🚚
8	6	13	500	4,15	20	080290106
10	8	13,5	750	5,05	15	080290108
11	10	17	1000	7,10	15	080290110
13	11	18,5	1500	9,45	10	080290111
16	13	20,5	2000	9,75	8	080290112
19	16	27	3250	16,70	8	080290116
22	19	32	4750	24,50	4	080290120
25	22	37	6500	37,00	4	080290122
28	26	43,5	8500	50,50	1	080290124

Robur

ØD mm	ØA mm	H mm	WLL kg	€		
32	29	48	9500	94,00	1	080290128
35	32	53	12000	125,50	1	080290132
38	35	59	13500	165,00	1	080290135
42	38	62	17000	216,00	1	080290138
50	45	75	25000	369,00	1	080290145
57	50	83	35000	646,00	1	080290150
65	57	95	42500	1.112,00	1	080290157
70	65	105	55000	1.275,00	1	080290165

Speciale service verpakking



ØD mm		€		
8	1	5,65	1	080299106
10	1	6,45	1	080299108
11	1	8,70	1	080299110
13	1	11,00	1	080299111
16	1	11,20	1	080299112
19	1	18,80	1	080299116

speciale pakken



ØD mm	ØA mm		€		
8	6	10	46,50	1	080290706
10	8	10	57,00	1	080290708
11	10	10	80,00	1	080290710
13	11	5	53,00	1	080290711
16	13	4	44,00	1	080290712
19	16	4	75,00	1	080290716
22	19	2	55,00	1	080290720
25	22	2	83,00	1	080290722

8031R

Harpssluitingen voor hef werkzaamheden, staal met hoge treksterkte, veiligheidsbout. Gegloeid en gegalvaniseerd.

CE



EN 13889

TECHNICAL DATA

- minimum safety factor: 6
- heat treatment: hardening and tempering
- traceability code on pin and body

LABORATORY TESTS

- chemical analysis
- metallographic analysis
- tensile test
- fatigue test (min. 20,000 cycles)
- proof load test (2 x WLL)

AVAILABLE CERTIFICATES

- Technical Product Specifications
- Test Report UNI EN10204 type 2.2
- Inspection Certificate UNI EN10204 type 3.1
- CE Declaration of Conformity

ØD mm	ØA mm	H mm	WLL kg	€		
11	10	17	1000	7,70	5	080310110
13	11	18	1500	11,80	5	080310111
16	13	21	2000	12,00	5	080310112
19	16	27	3250	20,60	3	080310116
22	19	32	4750	29,00	2	080310120
25	22	37	6500	40,50	2	080310122
28	26	43	8500	60,00	1	080310124

ØA mm	ØD mm	H mm	WLL kg	€		
29	32	48	9500	103,00	1	080310128
32	35	53	12000	133,00	1	080310132
35	38	59	13500	187,00	1	080310135
38	42	62	17000	228,50	1	080310138
45	50	75	25000	401,00	1	080310145
50	57	83	35000	703,00	1	080310150
65	70	105	55000	1.440,00	1	080310165
75	83	127	85000	2.180,00	1	080310183

Speciale service verpakking



ØD mm		€		
16	1	14,90	1	080319112
19	1	25,50	1	080319116

8032

Harpssluitingen voor hef werkzaamheden, staal met hoge treksterkte, verzonken vierkanten pin. Gegloeid en gegalvaniseerd.

CE



TECHNICAL DATA

- minimum safety factor: 6
- heat treatment: hardening and tempering
- traceability code on pin and body

LABORATORY TESTS

- chemical analysis
- metallographic analysis
- tensile test
- fatigue test (min. 20,000 cycles)
- proof load test (2 x WLL)

AVAILABLE CERTIFICATES

- Technical Product Specifications
- Test Report UNI EN10204 type 2.2
- Inspection Certificate UNI EN10204 type 3.1
- CE Declaration of Conformity

ØD mm	ØA mm	H mm	WLL kg	€		
11	10	17	1000	9,10	5	080320010
16	13	21	2000	11,50	5	080320012
19	16	27	3250	20,90	3	080320016
22	19	32	4750	36,50	2	080320020
25	22	37	6500	52,50	2	080320022

Speciale service verpakking



ØD mm		€		
16	1	13,80	1	080329012
19	1	22,90	1	080329016



8025

D-sluitingen voor het hefwerkzaamheden, heet gesmeed koolstof staal, groot model gegalvaniseerd

CE

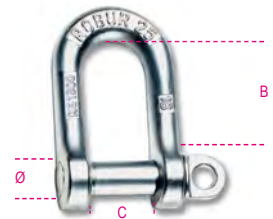

TECHNISCHE DATA

- Veiligheids factor: 5
- Hittebehandeling: genormaliseerd
- Identificatie code

LABORATORIUM TEST

- Chemische analyse
- Metalgrafische analyse
- Treksterkte test

VERKRIJGBARE CERTIFICATEN

- Technische product specificaties
- Test rapport UNI EN10204 type 2.2
- Inspectie certificaat UNI EN10204 type 3.1
- CE conformiteits verklaring

Ø mm	≈ "	B x C mm	WLL kg	€		
5	3/16	21x10	70	1,61	250	080250005
6	1/4	25x12	100	2,18	250	080250006
8	5/16	33x16	250	3,65	150	080250008
10	3/8	42x20	400	4,00	180	080250010
11	7/16	46x22	500	4,90	130	080250011
12	1/2	50x24	600	5,25	100	080250012
14	9/16	57x28	800	6,85	70	080250014
16	5/8	61x32	1000	8,95	10	080250016
18	11/16	65x36	1300	13,00	10	080250018
20	3/4	70x40	1600	15,30	10	080250020
22	7/8	74x44	2000	21,00	10	080250022
25	1"	80x48	2800	28,00	2	080250025

Speciale verpakking



Ø mm		€			
5	3/16	25	45,00	1	080250705
6	1/4	25	61,50	1	080250706
8	5/16	25	102,50	1	080250708
10	3/8	15	67,50	1	080250710
11	7/16	12	66,00	1	080250711
12	1/2	12	71,00	1	080250712
14	9/16	10	77,00	1	080250714

Speciale service verpakking



Ø mm		€		
5	4	8,10	1	080259205
6	4	10,30	1	080259206
8	2	8,65	1	080259208
10	2	9,25	1	080259210
11	1	6,05	1	080259011
12	1	6,60	1	080259012
14	1	8,10	1	080259014
16	1	10,20	1	080259016
18	1	15,30	1	080259018
20	1	17,20	1	080259020
22	1	22,30	1	080259022
25	1	29,00	1	080259025

8026A

D-sluitingen voor het hefwerkzaamheden, heet gesmeed koolstof staal, UNI 1947 type A, gegalvaniseerd

CE

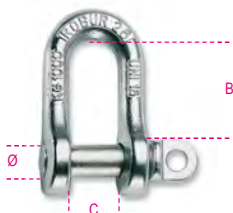

TECHNISCHE DATA

- Veiligheids factor: 5
- Hittebehandeling: normalisering
- Identificatie code
- LABORATORIUM TEST
- Chemische analyse
- Metalgrafische analyse
- Treksterkte test
- VERKRIJGBARE CERTIFICATEN
- Technische product specificaties
- Test rapport UNI EN10204 type 2.2
- Inspectie certificaat UNI EN10204 type 3.1
- CE conformiteits verklaring

Ø mm	"	B x C mm	WLL kg	€		
12	1/2	42x20	630	5,05	35	080260012
14	9/16	46x22	800	6,25	30	080260014
16	5/8	50x24	1000	8,10	20	080260016
18	11/16	54x26	1300	11,40	15	080260018
20	3/4	58x28	1600	14,30	10	080260020
22	7/8	69x32	2000	18,80	10	080260022
25	1"	79x36	2500	26,50	5	080260025
28	1.1/8	90x40	3150	37,00	2	080260028
32	1.1/4	100x45	4000	50,50	1	080260032
36	1.3/8	110x50	5000	72,00	1	080260036
40	1.9/16	120x55	6300	100,00	1	080260040
42	1.5/8	131x60	8000	136,00	1	080260042
45	1.3/4	143x65	10000	186,00	1	080260045
50	2"	155x70	12500	231,00	1	080260050

Speciale service verpakking



Ø mm	"	€		
12	1	6,50	1	080269012
14	1	7,80	1	080269014
16	1	9,10	1	080269016
18	1	13,80	1	080269018
20	1	16,50	1	080269020
22	1	21,00	1	080269022
25	1	29,00	1	080269025

Robur

8028

Harp sluitingen voor het hefwerkzaamheden, heet gesmeed koolstof staal, gegalvaniseerd

CE

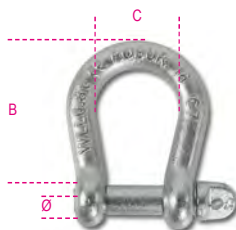

TECHNISCHE DATA

- Veiligheids factor: 5
- Hittebehandeling: normalisering
- Identificatie code
- LABORATORIUM TEST
- Chemische analyse
- Metalgrafische analyse
- Treksterkte test
- VERKRIJGBARE CERTIFICATEN
- Technische product specificaties
- Test rapport UNI EN10204 type 2.2
- Inspectie certificaat UNI EN10204 type 3.1
- CE conformiteits verklaring

Ø mm	"	B x C mm	WLL kg	€		
5	3/16	20x16	80	1,39	100	080280105
6	1/4	24x20	100	2,06	70	080280106
8	5/16	32x24	200	3,60	35	080280108
10	3/8	40x33	300	4,10	25	080280110
12	1/2	48x39	500	6,50	15	080280112
14	9/16	56x46	600	9,25	7	080280114
16	5/8	64x46	800	13,90	10	080280116
18	11/16	71x59	950	17,20	5	080280118
20	3/4	80x65	1100	24,50	5	080280120
22	7/8	88x72	1500	30,50	5	080280122
25	1"	100x81	2000	47,50	2	080280125
28	1.1/8	112x91	2600	73,00	1	080280128
32	1.1/4	128x104	3200	100,50	1	080280132
38	1.1/2	152x124	4500	199,50	1	080280138

Speciale service verpakking



Ø mm	"	€		
5	4	6,85	1	080289305
6	4	9,90	1	080289306
8	2	8,90	1	080289308
10	2	9,60	1	080289310
12	1	7,95	1	080289112
14	1	10,70	1	080289114
16	1	15,20	1	080289116
18	1	19,20	1	080289118
20	1	26,50	1	080289120
22	1	34,50	1	080289122

8049 WLL (t)

	A°	M8	M10	M12	M16	M20	M24	M30
	0°	0,3	0,6	1	1,6	2,5	4	6,3
	0°	0,6	1,2	2	3,2	5	8	12,6
	90°	0,3	0,6	1	1,6	2,5	4	6,3
	90°	0,6	1,2	2	3,2	5	8	12,6
	0°	0,4	0,8	1,4	2,2	3,5	5,6	8,8
	45°							
	60°	0,3	0,6	1	1,6	2,5	4	6,3
	0°	0,6	1,3	2,1	3,4	5,3	8,4	13,2
	45°							
	60°	0,3	0,6	1	1,6	2,3	4	6,3

8049

Lastring, dubbelverbonden, hoogwaardig staallegering

CE

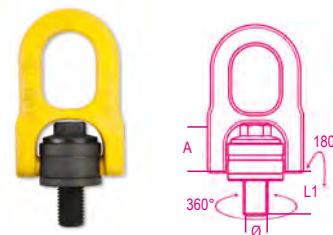

TECHNISCHE DATA









- Veiligheids factor: 5
- Hittebehandeling: gehard en getemperd
- LABORATORIUM TEST
- Chemische analyse
- Metalgrafische analyse
- Treksterkte test (min. 6 x WLL)
- Vermoeidheids test (min. 20.000 cycles)
- VERKRIJGBARE CERTIFICATEN
- Technische product specificaties
- Test rapport UNI EN10204 type 2.2
- Inspectie certificaat UNI EN10204 type 3.1
- CE conformiteits verklaring

Ø mm	A mm	L1 mm	WLL 90° kg	€		
M8	31,5	14	300	138,50	1	080490008
M10	31,5	17	600	144,00	1	080490010
M12	31,5	21	1000	148,00	1	080490012
M16	45	27	1600	170,00	1	080490016
M20	45	30	2500	174,00	1	080490020
M24	60,5	36	4000	299,00	1	080490024
M30	60,5	45	6300	311,00	1	080490030

Robur

Robur

8049A WLL (kg)

	B°	M6	M8	M10	M12	M16	M20	M24	M30	M36
	0°	400	600	900	1000	2000	4000	6300	10600	11800
	0°	800	1200	1800	2000	4000	8000	12600	21200	23600
	90°	200	300	450	500	1120	2000	3150	5300	8000
	90°	400	600	900	1000	2000	4000	6300	10600	16000
	0° 45°	250	400	600	700	1400	2800	4250	7100	10700
	45° 60°	200	300	450	500	1120	2000	3150	5300	8000
	0° 45°	400	600	900	1000	2100	4200	6300	11200	16000
	45° 60°	250	400	600	750	1500	3000	4750	8000	10700

8049A

Lastringen,
dubbele draaibare ring, draaibaar onder
belasting,
met gelaste ring,
hoogwaardige staallegering

CE



TECHNISCHE DATA

- Veiligheids factor: 4
 - Hittebehandeling: gehard
 - Identificatie code
- ### LABORATORIUM TESTS
- Chemische analyse
 - Metallografische analyse
 - Treksterkte test
 - Vermoeidheids test (20.000 cycli)
 - Laadbelastingstest (100% van de productie)
- ### VERKRIJGBARE CERTIFICATEN
- Technische product specificaties
 - Test rapport UNI EN10204 type 2.2
 - Inspectie certificaat UNI EN10204 type 3.1
 - CE conformiteits verklaring

Ø	E	A	WLL 90°	€		
mm	mm	mm	kg			
M6	13	30	200	46,00	1	080490106
M8	13	30	300	47,00	1	080490108
M10	19	30	450	49,00	1	080490110
M12	19	30	500	52,00	1	080490112
M16	20	30	1120	55,50	1	080490116
M20	30	40	2000	79,50	1	080490120
M24	30	40	3150	117,00	1	080490124
M30	35	50	5300	202,00	1	080490130
M36	54	50	8000	212,50	1	080490136

8049V

Hijsogen
met offset beugels,
gelegeerd staal met hoge treksterkte
360° draaibare oogbout en draaibeugel

CE



TECHNISCHE GEGEVENS

- veiligheidsfactor: 4
 - warmtebehandeling: harden en ontlaten
 - traceerbaarheidscode
- ### LABORATORIUM TESTS
- chemische analyse
 - metallografische analyse
 - trekproef
 - vermoeidheidstest (20.000 cycli)
 - testlading (alle units)
- ### BESCHIKBARE CERTIFICATEN
- Technische productspecificaties
 - Testrapport UNI EN10204 type 2.2
 - Keuringscertificaat UNI EN10204 type 3.1
 - CE-Certificaat

Ø	E	B	WLL	€		
mm	mm	mm	kg			
M10	13,5	37	630	76,50	1	080490310
M12	18	37,5	1000	93,50	1	080490312
M16	24	37,5	1500	100,00	1	080490316
M20	35,5	54	2500	145,00	1	080490320
M24	35,5	54	4000	149,50	1	080490324

8068S

aangelaste beugels voor het hijsen van lasten,
enkelvoudig, met positioneringsveren,
hoge treksterkte gelegeerd stalen behuizing

- Compacte afmetingen voor hijswerkzaamheden
- Getest om 20.000 werkcycli bij volledige belasting te doorstaan
- Testbelasting toegepast op 100% van de onderdelen vóór verkoop
- Veiligheidsfactor: 4, in alle richtingen

CE



TECHNISCHE DATA

- veiligheidsfactor: 4
 - warmtebehandeling: uitharding
 - traceerbaarheidscode
- ### LABORATORIUM TESTEN
- chemische analyse
 - metallografische analyse
 - trekproef
 - vermoeidheidstest (20.000 cycli)
 - laadtest (100% of batch)
- ### BESCHIKBARE CERTIFICATEN
- Technische productspecificaties
 - Testrapport UNI EN10204 type 2.2
 - Keuringscertificaat UNI EN10204 type 3.1
 - CE-verklaring van overeenstemming

WLL	B	M	A	€		
Kg	mm	mm	mm			
1500	78	37	41	11,30	1	080680115
2500	88	40	42	14,70	1	080680125
4000	94	42	45	21,20	1	080680140
6700	118	51	55	39,50	1	080680167

Voorzichtigheid:

- Koppellement moet zorgen voor een goede mechanische weerstand en geschikt zijn om te lassen.
- Lassen moet worden uitgevoerd door opgeleide personeel.

8041

Oogbouten,
Staallegering met hoge treksterkte

CE



TECHNISCHE DATA

- Veiligheidsfactor: 4
 - Hittebehandeling: gehard en getemperd
 - Identificatie code
- ### LABORATORIUM TESTS
- Chemische analyse
 - Metallografische analyse
 - Treksterkte test
 - Vermoeidheids test (20.000 cycles)
 - Laad belastingstest (100% van de productie)
- ### VERKRIJGBARE CERTIFICATEN
- Technische product specificaties
 - Test rapport UNI EN10204 type 2.2
 - Inspectie certificaat UNI EN10204 type 3.1
 - CE conformiteits verklaring

Ø	E	WLL	€		
mm	mm	kg			
M6	1	11	400	3,75	10 080410206
* M8	1,25	13	800	3,75	10 080410208
* M10	1,5	17	1000	5,75	6 080410210
* M12	1,75	20,5	1600	8,70	4 080410212
* M14	2	20,5	3000	14,30	2 080410214
M16	2,5	27	4000	21,70	2 080410217
M18	2,5	27	5000	21,70	2 080410218
M20	3,0	30	6000	40,50	2 080410221
M22	2,5	30	7000	40,50	2 080410222
M24	3	36	8000	49,00	2 080410225
M27	3	41	10000	74,50	1 080410227
* M30	3,5	45	12000	74,50	1 080410230

(*) Afmeting specifica-ties DIN 580:2010

WLL Verhoogt volgens de Robur Techni-sche Product Specifica-ties

Speciale service verpakking



Ø	€		
mm			
* M8	1	5,95	1 080419208
* M10	1	8,35	1 080419210
* M12	1	11,50	1 080419212

 **Robur**

 **Robur**

8043

Oogmoeren,
Staallegering met hoge treksterkte

CE

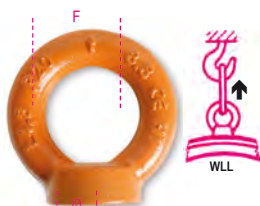

TECHNISCHE DATA

- Veiligheidsfactor: 4
- Hittebehandeling: gehard en getemperd
- Identificatie code

LABORATORIUM TESTS

- Chemische analyse
- Metalgrafische analyse
- Treksterkte test
- Vermoeidheids test (20,000 cycles)
- Laad belastings test (100% van de productie)

VERKRIJGBARE CERTIFICATEN

- Technische product specificaties
- Test rapport UNI EN10204 type 2.2
- Inspectie certificaat UNI EN10204 type 3.1
- CE conformiteits verklaring

Ø mm	F mm	WLL kg	€	1	10	60
M6	1 20	400	3,65	10	080430206	
* M8	1,25 20	800	3,65	10	080430208	
* M10	1,50 25	1000	5,65	6	080430210	
* M12	1,75 30	1600	8,60	4	080430212	
M14	2 35	3000	14,00	2	080430214	
M16	2 40	4000	20,30	2	080430217	
M18	2,5 40	5000	20,30	2	080430218	
M20	2,5 50	6000	39,50	2	080430221	
M22	2,5 50	7000	39,50	2	080430222	
M24	3 55	8000	46,00	2	080430225	
M27	3 60	10000	71,00	1	080430227	
* M30	3,5 60	12000	71,00	1	080430230	

(* Afmeting specificaties DIN 580:2010

WLL Verhoogt volgens de Robur Technische Product Specificaties

Speciale service verpakking



Ø mm	1	€	1	10
* M8	1	5,65	1	080439208
* M10	1	8,10	1	080439210
* M12	1	11,00	1	080439212

OOGMOEREN EN BOUTEN



De oogmoeren en bouten van Robur zijn gemaakt van zacht koolstofstaal, met toevoeging van een minimaal aluminiumgehalte, en moeten voldoen aan strenge parameters met betrekking tot de korrelgrootte van het materiaal, conform DIN580-582.

Uitstekend mechanisch vakmanschap speelt ook een rol bij het maken van een verschil: de reliëfgroef van de kragen aan de basis van de ogen/moeren resulteert in verbeterde grip en volledig contact met het oppervlak van het lichaam dat moet worden opgetild. Op basis van deze kenmerken zijn onze oogmoeren-/bouten ideaal voor complexe hijstaken en intensief gebruik, b.v. in omgevingen met continue cycluswerking of een temperatuurbereik van -20 °C ÷ +200 °C.

8040EZ

Oogbouten, gegalvaniseerd

CE



DIN 580:2018-04(**)

TECHNISCHE DATA

- veiligheidsfactor: 6
- warmtebehandeling: normaliseren
- traceerbaarheidscode

LABORATORIUM TESTEN

- chemische analyse
- metallografische analyse
- trekproef

BESCHIKBARE CERTIFICATEN

- Technische productspecificaties
- Testrapport UNI EN10204 type 2.2
- Keuringscertificaat UNI EN10204 type 3.1
- CE-verklaring van overeenstemming

Ø mm	F mm	E mm	WLL kg	€	1	60
* M6	1 11	90	2,02	60	080400406	
M8	1,25 13	140	2,02	60	080400408	
M10	1,5 17	230	2,71	40	080400410	
M12	1,75 20,5	340	3,65	20	080400412	
* M14	2 20,5	480	4,80	20	080400414	
M16	2 27	700	5,95	10	080400416	
* M18	2,5 27	930	7,20	10	080400418	
M20	2,5 30	1200	9,25	10	080400420	
* M22	2,5 30	1450	11,90	10	080400422	
M24	3 36	1800	17,60	5	080400424	
* M27	3 41	2400	21,70	5	080400427	
M30	3,5 45	3200	36,50	2	080400430	
* M33	3,5 54	3900	50,50	2	080400433	
* M33F	2 54	3900	50,50	2	080400434	
M36	4 54	4600	52,00	2	080400436	
* M36F	3 54	4600	52,00	2	080400437	
M42	4,5 63	6300	96,00	1	080400442	
* M42F	3 63	6300	96,00	1	080400443	
M48	5 68	8600	153,50	1	080400448	
* M48F	3 68	8600	153,50	1	080400449	
M56	5,5 78	11500	251,00	1	080400456	
* M56F	4 78	11500	251,00	1	080400457	
M64	6 90	16000	368,00	1	080400464	
* M64F	4 90	16000	368,00	1	080400465	

*Maten gedimensioneerd volgens Robur Technisch Dossier

speciale pakken



Ø mm	F mm	1	€	1	10
M6	1 20	45,50	1	080400906	
M8	1,25 20	45,50	1	080400908	
M10	1,5 20	61,00	1	080400910	
M12	1,75 15	61,50	1	080400912	

Speciale service verpakking



Ø mm	1	€	1	10
M6	4	10,10	1	080409606
M8	4	10,10	1	080409608
M10	2	7,55	1	080409610
M12	1	5,15	1	080409412
* M14	1	6,05	1	080409414
M16	1	7,55	1	080409416
* M18	1	8,85	1	080409418
M20	1	10,70	1	080409420

Ø mm	1	€	1	10
* M22	1	14,00	1	080409422
M24	1	18,90	1	080409424
* M27	1	23,70	1	080409427
M30	1	37,50	1	080409430

8040EN

Oogbouten, zelf-kleurend

CE



DIN 580:2018-04(**)

TECHNISCHE DATA

- veiligheidsfactor: 6
- warmtebehandeling: normaliseren
- traceerbaarheidscode

LABORATORIUM TESTEN

- chemische analyse
- metallografische analyse
- trekproef

BESCHIKBARE CERTIFICATEN

- Technische productspecificaties
- Testrapport UNI EN10204 type 2.2
- Keuringscertificaat UNI EN10204 type 3.1
- CE-verklaring van overeenstemming

Ø mm	F mm	E mm	WLL kg	€	1	60
* M6	1 11	90	1,95	60	080400306	
M8	1,25 13	140	1,95	60	080400308	
M10	1,5 17	230	2,65	40	080400310	
M12	1,75 20,5	340	3,65	20	080400312	
* M14	2 20,5	480	4,55	20	080400314	
M16	2 27	700	5,65	10	080400316	
* M18	2,5 27	930	7,00	10	080400318	
M20	2,5 30	1200	8,70	10	080400320	
* M22	2,5 30	1450	11,40	10	080400322	
M24	3 36	1800	16,10	5	080400324	
* M27	3 41	2400	20,20	5	080400327	
M30	3,5 45	3200	34,50	2	080400330	
* M33	3,5 54	3900	47,50	2	080400333	
* M33F	2 54	3900	47,50	2	080400334	
M36	4 54	4600	50,00	2	080400336	
* M36F	3 54	4600	50,00	2	080400337	
M42	4,5 63	6300	92,00	1	080400342	
* M42F	3 63	6300	92,00	1	080400343	
M48	5 68	8600	150,50	1	080400348	
* M48F	3 68	8600	150,50	1	080400349	
M56	5,5 78	11500	239,00	1	080400356	
* M56F	4 78	11500	239,00	1	080400357	
M64	6 90	16000	348,00	1	080400364	
* M64F	4 90	16000	348,00	1	080400365	

*Maten gedimensioneerd volgens Robur Technisch Dossier

Speciale service verpakking



Ø mm	1	€	1	10
M6	4	9,45	1	080409506
M8	4	9,45	1	080409508
M10	2	6,90	1	080409510
M12	1	4,90	1	080409312
* M14	1	5,85	1	080409314
M16	1	6,90	1	080409316
* M18	1	8,25	1	080409318
M20	1	9,60	1	080409320
* M22	1	13,10	1	080409322
M24	1	17,60	1	080409324
* M27	1	21,70	1	080409327
M30	1	35,50	1	080409330

8042EZ

Oogmoeren, gegalvaniseerd

CE



DIN582:2018-04(**)

TECHNISCHE DATA

- veiligheidsfactor: 6
- warmtebehandeling: normaliseren
- traceerbaarheidscode

LABORATORIUM TESTEN

- chemische analyse
- metalografische analyse
- trekproef

BESCHIKBARE CERTIFICATEN

- Technische productspecificaties
- Testrapport UNI EN10204 type 2.2
- Keuringscertificaat UNI EN10204 type 3.1
- CE-verklaring van overeenstemming

Ø mm	WLL mm	F mm	WLL kg	€	Hand	Truck
* M6	1	14	90	2,02	60	080420406
M8	1,25	20	140	2,02	60	080420408
M10	1,5	25	230	2,71	40	080420410
M12	1,75	30	340	3,75	30	080420412
* M14	2	30	480	4,80	30	080420414
M16	2	35	700	5,95	20	080420416
* M18	2,5	35	930	7,20	20	080420418
M20	2,5	40	1200	9,10	10	080420420
* M22	2,5	40	1450	11,80	10	080420422
M24	3	50	1800	17,60	5	080420424
* M27	3	55	2400	21,00	5	080420427
M30	3,5	60	3200	34,50	3	080420430
M36	4	70	4600	51,50	2	080420436
* M36F	3	70	4600	51,50	2	080420437
M42	4,5	80	6300	93,50	1	080420442
* M42F	3	80	6300	93,50	1	080420443
M48	5	90	8600	151,50	1	080420448
* M48F	3	90	8600	151,50	1	080420449

*Maten gedimensioneerd volgens Robur Technisch Dossier

speciale pakken



Ø mm	WLL mm	€	Hand	Truck
M6	1	20	44,00	1 080420906
M8	1,25	20	44,00	1 080420908
M10	1,5	20	59,50	1 080420910
M12	1,75	15	61,50	1 080420912

Speciale service verpakking



Ø mm	Hand	€	Truck
M6	4	9,75	1 080429606
M8	4	9,75	1 080429608
M10	2	7,00	1 080429610
M12	1	5,15	1 080429412
* M14	1	5,85	1 080429414
M16	1	7,20	1 080429416
* M18	1	8,35	1 080429418
M20	1	10,30	1 080429420
* M22	1	13,10	1 080429422
M24	1	20,20	1 080429424
* M27	1	22,30	1 080429427
M30	1	35,00	1 080429430



8042EN

Oogmoeren zelf-kleurend

CE



DIN582:2018-04(**)

TECHNISCHE DATA

- veiligheidsfactor: 6
- warmtebehandeling: normaliseren
- traceerbaarheidscode

LABORATORIUM TESTEN

- chemische analyse
- metalografische analyse
- trekproef

BESCHIKBARE CERTIFICATEN

- Technische productspecificaties
- Testrapport UNI EN10204 type 2.2
- Keuringscertificaat UNI EN10204 type 3.1
- CE-verklaring van overeenstemming

Ø mm	WLL mm	F mm	WLL kg	€	Hand	Truck
* M6	1	14	90	1,95	60	080420306
M8	1,25	20	140	1,95	60	080420308
M10	1,5	25	230	2,59	40	080420310
M12	1,75	30	340	3,65	30	080420312
* M14	2	30	480	4,65	30	080420314
M16	2	35	700	5,45	20	080420316
* M18	2,5	35	930	6,90	20	080420318
M20	2,5	40	1200	8,35	10	080420320
* M22	2,5	40	1450	11,20	10	080420322
M24	3	50	1800	16,10	5	080420324
* M27	3	55	2400	19,50	5	080420327
M30	3,5	60	3200	30,50	3	080420330
M36	4	70	4600	47,50	2	080420336
* M36F	3	70	4600	47,50	2	080420337
M42	4,5	80	6300	88,00	1	080420342
* M42F	3	80	6300	88,00	1	080420343
M48	5	90	8600	144,00	1	080420348
* M48F	3	90	8600	144,00	1	080420349

*Maten gedimensioneerd volgens Robur Technisch Dossier

Speciale service verpakking



Ø mm	Hand	€	Truck
M6	4	9,45	1 080429506
M8	4	9,45	1 080429508
M10	2	6,90	1 080429510
M12	1	4,80	1 080429312
* M14	1	5,65	1 080429314
M16	1	6,90	1 080429316
* M18	1	8,10	1 080429318
M20	1	9,75	1 080429320
* M22	1	12,60	1 080429322
M24	1	18,20	1 080429324
* M27	1	21,70	1 080429327
M30	1	33,50	1 080429330

8044

Oogmoeren zelfkleurend

CE



UNI 2948

TECHNISCHE DATA

- Veiligheids factor: 4
 - Hittebehandeling: genormaliseerd
 - Identificatie code
- ### LABORATORIUM TEST
- Chemische analyse
 - Metalgrafische analyse
 - Treksterkte test
- ### VERKRIJGBARE CERTIFICATEN
- Technische product specificaties
 - Test rapport UNI EN10204 type 2.2
 - Inspectie certificaat UNI EN10204 type 3.1
 - CE conformiteits verklaring

Ø mm	WLL mm	WLL kg	€	Hand	Truck
M8	1,25	80	2,59	4	080440008
M10	1,5	160	4,20	4	080440010
M12	1,75	250	7,35	4	080440012
M14	2	250	11,90	2	080440014
M16	2	400	12,00	2	080440016
M20	2,5	630	20,20	2	080440020
M24	3	1000	35,50	2	080440024

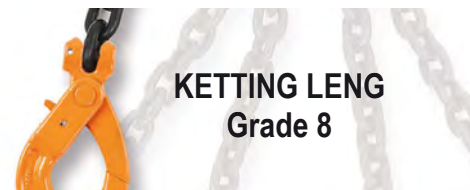

KETTING LENG Grade 8

WLL Ton		UNI EN 818	
Ø D mm	WLL 1	WLL 2	
		0° < β ≤ 45°	45° < β ≤ 60°
6	1,12	1,6	1,12
7	1,5	2,12	1,5
8	2	2,8	2
10	3,15	4,25	3,15
13	5,3	7,5	5,3
16	8	11,2	8

Ø D mm	WLL 3	WLL 3	
		0° < β ≤ 45°	45° < β ≤ 60°
6	2,36	1,7	
7	3,15	2,24	
8	4,25	3	
10	6,7	4,75	
13	11,2	8	
16	17	11,2	

8091

Ketting leng, 1 sprong. In kunststof koffer

Zelfsluitend en kettinghaken op verzoek leverbaar

CE

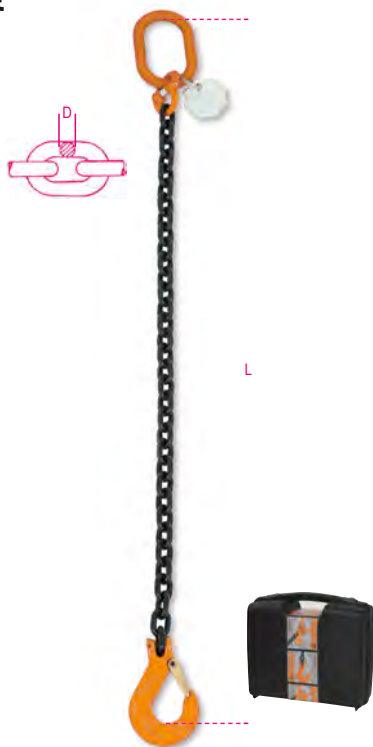

UNI EN 818-4

TECHNISCHE DATA

- Veiligheids factor: 4
- Kettingleng identificatie label MEEGELEVERDE CERTIFICATEN
- Fabricage Certificaat UNI EN818-4
- CE conformiteits verklaring VERKRIJGBARE CERTIFICATEN
- Technische product specificaties

D mm	L m	WLL ton	€		
6*	1	1,12	85,50	1	080910001
6*	2	1,12	105,00	1	080910002
6*	3	1,12	124,00	1	080910003
6*	4	1,12	143,00	1	080910004
7*	1	1,5	93,50	1	080910021
7*	2	1,5	118,00	1	080910022
7*	3	1,5	142,50	1	080910023
7*	4	1,5	167,00	1	080910024
8*	1	2	104,50	1	080910041
8*	2	2	133,50	1	080910042
8*	3	2	162,50	1	080910043
8*	4	2	204,50	1	080910044
10*	1	3,15	133,50	1	080910051
10*	2	3,15	176,50	1	080910052
10*	3	3,15	232,50	1	080910053
10*	4	3,15	276,00	1	080910054
13*	1	5,3	215,00	1	080910131
13*	2	5,3	289,00	1	080910132
13*	3	5,3	359,00	1	080910133
13*	4	5,3	433,00	1	080910134
16*	1	8	421,00	1	080910161
16*	2	8	530,00	1	080910162
16*	3	8	642,00	1	080910163
16*	4	8	754,00	1	080910164
20	1	12,5	830,00	1	080910171
20	2	12,5	1.044,00	1	080910172
20	3	12,5	1.260,00	1	080910173
20	4	12,5	1.470,00	1	080910174

* Houten kist geschikt aan het gewicht

8091SL

Ketting leng, 1 sprong, zelfsluitende haak, grade 8

CE

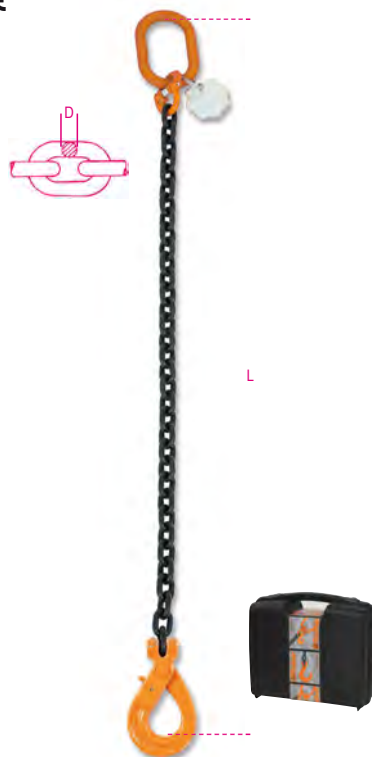

UNI EN 818-4

TECHNISCHE DATA

- Veiligheids factor: 4
- Ketting leng identificatie label MEEGELEVERDE CERTIFICATEN
- Fabricage Certificaat UNI EN818-4
- CE conformiteits verklaring VERKRIJGBARE CERTIFICATEN
- Technische product specificaties

D mm	L m	WLL ton	€		
6*	1	1,12	108,00	1	080910201
6*	2	1,12	127,00	1	080910202
6*	3	1,12	146,00	1	080910203
6*	4	1,12	165,00	1	080910204
7*	1	1,5	123,50	1	080910221
7*	2	1,5	148,00	1	080910222
7*	3	1,5	172,50	1	080910223
7*	4	1,5	197,00	1	080910224
8*	1	2	134,50	1	080910241
8*	2	2	157,50	1	080910242
8*	3	2	192,50	1	080910243
8*	4	2	234,50	1	080910244
10*	1	3,15	168,00	1	080910251
10*	2	3,15	211,00	1	080910252
10*	3	3,15	267,00	1	080910253
10*	4	3,15	323,00	1	080910254
13*	1	5,3	295,00	1	080910331
13*	2	5,3	391,00	1	080910332
13*	3	5,3	442,00	1	080910333
13*	4	5,3	535,00	1	080910334
16*	1	8	555,00	1	080910361
16*	2	8	698,00	1	080910362
16*	3	8	777,00	1	080910363
16*	4	8	922,00	1	080910364
20	1	12,5	1.310,00	1	080910401
20	2	12,5	1.525,00	1	080910402
20	3	12,5	1.740,00	1	080910403
20	4	12,5	1.955,00	1	080910404

* Geleverd in kunststof koffer

8092

Ketting leng, 2 sprong. In kunststof koffer

Zelfsluitend en kettinghaken op verzoek leverbaar

CE



EN 818-4

TECHNISCHE DATA

- Veiligheids factor: 4
- Kettingleng identificatie label MEEGELEVERDE CERTIFICATEN
- Fabricage Certificaat UNI EN818-4
- CE conformiteits verklaring VERKRIJGBARE CERTIFICATEN
- Technische product specificaties

D mm	L m	WLL ton	€		
6*	1	1,6	125,50	1	080920001
6*	2	1,6	164,00	1	080920002
6*	3	1,6	202,00	1	080920003
6*	4	1,6	253,00	1	080920004
7*	1	2,12	146,00	1	080920021
7*	2	2,12	195,00	1	080920022
7*	3	2,12	257,00	1	080920023
7*	4	2,12	306,00	1	080920024
8*	1	2,8	165,50	1	080920041
8*	2	2,8	223,50	1	080920042
8*	3	2,8	294,00	1	080920043
8*	4	2,8	352,00	1	080920044
10*	1	4,25	239,50	1	080920051
10*	2	4,25	325,00	1	080920052
10*	3	4,25	409,00	1	080920053
10*	4	4,25	495,00	1	080920054
13*	1	7,5	381,00	1	080920131
13*	2	7,5	526,00	1	080920132
13	3	7,5	652,00	1	080920133
13	4	7,5	850,00	1	080920134
16*	1	11,2	764,00	1	080920161
16	2	11,2	1.018,00	1	080920162
16	3	11,2	1.240,00	1	080920163
16	4	11,2	1.465,00	1	080920164
20	2	17,0	2.080,00	1	080920172
20	3	17,0	2.510,00	1	080920173
20	4	17,0	2.930,00	1	080920174

* Houten kist geschikt aan het gewicht



Robur

8092SL

Ketting leng, 2 sprong, zelfsluitende haak, grade 8

CE



EN 818-4

TECHNISCHE DATA

- Veiligheids factor: 4
- Ketting leng identificate label MEEGELEVERDE CERTIFICATEN
- Fabricage Certificaat UNI EN818-4
- CE conformiteits verklaring VERKRIJGBARE CERTIFICATEN
- Technische product specificaties

D mm	L m	WLL ton	€	1	080920201
6*	1	1,6	170,00	1	080920201
6*	2	1,6	200,50	1	080920202
6*	3	1,6	239,00	1	080920203
6*	4	1,6	298,00	1	080920204
7*	1	2,12	205,00	1	080920221
7*	2	2,12	244,50	1	080920222
7*	3	2,12	316,00	1	080920223
7*	4	2,12	365,00	1	080920224
8*	1	2,8	213,50	1	080920241
8*	2	2,8	284,00	1	080920242
8*	3	2,8	342,00	1	080920243
8*	4	2,8	412,00	1	080920244
10*	1	4,25	334,00	1	080920251
10*	2	4,25	394,00	1	080920252
10*	3	4,25	478,00	1	080920253
10*	4	4,25	589,00	1	080920254
13*	1	7,5	586,00	1	080920331
13*	2	7,5	691,00	1	080920332
13*	3	7,5	857,00	1	080920333
13*	4	7,5	1.054,00	1	080920334
16*	1	11,2	1.100,00	1	080920361
16*	2	11,2	1.355,00	1	080920362
16*	3	11,2	1.580,00	1	080920363
16*	4	11,2	1.800,00	1	080920364
20	2	17,0	3.360,00	1	080920402
20	3	17,0	3.790,00	1	080920403
20	4	17,0	4.220,00	1	080920404

* Geleverd in kunststof koffer

8094

Ketting leng, 4 sprong. In kunststof koffer

Zelfsluitend en kettinghaken op verzoek leverbaar

CE



EN 818-4

TECHNISCHE DATA

- Veiligheids factor: 4
- Kettingleng identificatie label MEEGELEVERDE CERTIFICATEN
- Fabricage Certificaat UNI EN818-4
- CE conformiteits verklaring VERKRIJGBARE CERTIFICATEN
- Technische product specificaties

D mm	L m	WLL ton	€	1	080940001
6*	1	2,36	261,00	1	080940001
6*	2	2,36	350,00	1	080940002
6*	3	2,36	427,00	1	080940003
6*	4	2,36	500,00	1	080940004
7*	1	3,15	306,00	1	080940021
7*	2	3,15	404,00	1	080940022
7*	3	3,15	499,00	1	080940023
7*	4	3,15	597,00	1	080940024
8*	1	4,25	369,00	1	080940041
8*	2	4,25	482,00	1	080940042
8*	3	4,25	598,00	1	080940043
8	4	4,25	744,00	1	080940044
10*	1	6,7	486,00	1	080940051
10	2	6,7	671,00	1	080940052
10	3	6,7	860,00	1	080940053
10	4	6,7	1.032,00	1	080940054
13	1	11,2	810,00	1	080940131
13	2	11,2	1.104,00	1	080940132
13	3	11,2	1.395,00	1	080940133
13	4	11,2	1.690,00	1	080940134
16	1	17	1.590,00	1	080940161
16	2	17	2.035,00	1	080940162
16	3	17	2.485,00	1	080940163
16	4	17	2.930,00	1	080940164
20	2	26,5	3.760,00	1	080940172
20	3	26,5	4.620,00	1	080940173
20	4	26,5	5.480,00	1	080940174

* Houten kist geschikt aan het gewicht

Robur

Robur

8094SL

Ketting leng, 4 sprong, zelfsluitende haken, grade 8

CE



EN 818-4

TECHNISCHE DATA

- Veiligheids factor: 4
- Ketting leng identificate label MEEGELEVERDE CERTIFICATEN
- Fabricage Certificaat UNI EN818-4
- CE conformiteits verklaring VERKRIJGBARE CERTIFICATEN
- Technische product specificaties

D mm	L m	WLL ton	€	1	080940201
6*	1	2,36	350,00	1	080940201
6*	2	2,36	439,00	1	080940202
6*	3	2,36	516,00	1	080940203
6*	4	2,36	589,00	1	080940204
7*	1	3,15	424,00	1	080940221
7*	2	3,15	522,00	1	080940222
7*	3	3,15	618,00	1	080940223
7*	4	3,15	716,00	1	080940224
8*	1	4,25	465,00	1	080940241
8*	2	4,25	578,00	1	080940242
8*	3	4,25	717,00	1	080940243
8	4	4,25	863,00	1	080940244
10*	1	6,7	633,00	1	080940251
10	2	6,7	809,00	1	080940252
10	3	6,7	1.007,00	1	080940253
10	4	6,7	1.179,00	1	080940254
13	1	11,2	1.145,00	1	080940331
13	2	11,2	1.440,00	1	080940332
13	3	11,2	1.730,00	1	080940333
13	4	11,2	2.025,00	1	080940334
16	1	17	2.150,00	1	080940361
16	2	17	2.600,00	1	080940362
16	3	17	3.050,00	1	080940363
16	4	17	3.490,00	1	080940364
20	2	26,5	5.690,00	1	080940402
20	3	26,5	6.550,00	1	080940403
20	4	26,5	7.400,00	1	080940404

* Geleverd in kunststof koffer

8096

Ketting leng, 1 sprong met grijphaak. In kunststof koffer

CE



EN 818-4

TECHNISCHE DATA

- Veiligheids factor: 4
- Kettingleng identificatie label
- MEEGELEVERDE CERTIFICATEN
- Fabricage Certificaat UNI EN818-4
- CE conformiteits verklaring
- VERKRIJGBARE CERTIFICATEN
- Technische product specificaties

D mm	L m	WLL ton	€		
6*	1	1,12	101,50	1	080960001
6*	2	1,12	120,50	1	080960002
6*	3	1,12	139,50	1	080960003
6*	4	1,12	155,00	1	080960004
7*	1	1,5	112,50	1	080960021
7*	2	1,5	137,00	1	080960022
7*	3	1,5	156,50	1	080960023
7*	4	1,5	181,00	1	080960024
8*	1	2	124,00	1	080960041
8*	2	2	153,00	1	080960042
8*	3	2	182,00	1	080960043
8*	4	2	224,00	1	080960044
10*	1	3,15	171,50	1	080960051
10*	2	3,15	227,50	1	080960052
10*	3	3,15	270,00	1	080960053
10*	4	3,15	313,00	1	080960054
13*	1	5,3	281,00	1	080960131
13*	2	5,3	333,00	1	080960132
13*	3	5,3	403,00	1	080960133
13*	4	5,3	499,00	1	080960134
16*	1	8	553,00	1	080960161
16*	2	8	629,00	1	080960162
16*	3	8	741,00	1	080960163
16	4	8	883,00	1	080960164
20	1	12,5	1.133,00	1	080960171
20	2	12,5	1.345,00	1	080960172
20	3	12,5	1.560,00	1	080960173
20	4	12,5	1.775,00	1	080960174

* Houten kist aangepast aan het gewicht

8096SL

Ketting leng, 1 sprong, met zelfsluitende haak en grijphaak, grade 8

CE



EN 818-4

TECHNISCHE DATA

- Veiligheids factor: 4
- Ketting leng identificate label
- MEEGELEVERDE CERTIFICATEN
- Fabricage Certificaat UNI EN818-4
- CE conformiteits verklaring
- VERKRIJGBARE CERTIFICATEN
- Technische product specificaties

D mm	L m	WLL ton	€		
6*	1	1,12	120,00	1	080960201
6*	2	1,12	139,00	1	080960202
6*	3	1,12	158,00	1	080960203
6*	4	1,12	177,00	1	080960204
7*	1	1,5	137,00	1	080960221
7*	2	1,5	161,50	1	080960222
7*	3	1,5	186,00	1	080960223
7*	4	1,5	210,50	1	080960224
8*	1	2	148,00	1	080960241
8*	2	2	177,00	1	080960242
8*	3	2	206,00	1	080960243
8*	4	2	248,00	1	080960244
10*	1	3,15	206,00	1	080960251
10*	2	3,15	262,00	1	080960252
10*	3	3,15	305,00	1	080960253
10*	4	3,15	348,00	1	080960254
13*	1	5,3	361,00	1	080960331
13*	2	5,3	435,00	1	080960332
13*	3	5,3	505,00	1	080960333
13*	4	5,3	579,00	1	080960334
16*	1	8	688,00	1	080960361
16*	2	8	797,00	1	080960362
16*	3	8	909,00	1	080960363
16	4	8	1.017,00	1	080960364
20	1	12,5	1.615,00	1	080960401
20	2	12,5	1.830,00	1	080960402
20	3	12,5	2.045,00	1	080960403
20	4	12,5	2.255,00	1	080960404

* Geleverd in kunststof koffer

8097

Ketting leng, 2 sprong met grijphaak. In kunststof koffer

CE



EN 818-4

TECHNISCHE DATA

- Veiligheids factor: 4
- Kettingleng identificatie label
- MEEGELEVERDE CERTIFICATEN
- Fabricage Certificaat UNI EN818-4
- CE conformiteits verklaring
- VERKRIJGBARE CERTIFICATEN
- Technische product specificaties

D mm	L m	WLL ton	€		
6*	1	1,6	157,50	1	080970001
6*	2	1,6	188,00	1	080970002
6*	3	1,6	233,50	1	080970003
6*	4	1,6	277,00	1	080970004
7*	1	2,12	183,00	1	080970021
7*	2	2,12	235,50	1	080970022
7*	3	2,12	284,00	1	080970023
7*	4	2,12	333,00	1	080970024
8*	1	2,8	204,50	1	080970041
8*	2	2,8	264,00	1	080970042
8*	3	2,8	333,00	1	080970043
8*	4	2,8	391,00	1	080970044
10*	1	4,25	315,00	1	080970051
10*	2	4,25	401,00	1	080970052
10*	3	4,25	484,00	1	080970053
10*	4	4,25	570,00	1	080970054
13*	1	7,5	511,00	1	080970131
13*	2	7,5	658,00	1	080970132
13	3	7,5	791,00	1	080970133
13	4	7,5	938,00	1	080970134
16	1	11,2	991,00	1	080970161
16	2	11,2	1.215,00	1	080970162
16	3	11,2	1.440,00	1	080970163
16	4	11,2	1.660,00	1	080970164
20	2	17,0	2.395,00	1	080970172
20	3	17,0	2.830,00	1	080970173
20	4	17,0	3.250,00	1	080970174

* Houten kist aangepast aan het gewicht



8097SL

Ketting leng, met zelfsluitende haken en grijphaken, grade 8

CE



EN 818-4

TECHNISCHE DATA

- Veiligheids factor: 4
- Ketting leng identificate label MEEGELEVERDE CERTIFICATEN
- Fabricage Certificaat UNI EN818-4
- CE conformiteits verklaring VERKRIJGBARE CERTIFICATEN
- Technische product specificaties

D mm	L m	WLL ton	€	📄	📦
6*	1	1,6	194,00	1	080970201
6*	2	1,6	224,50	1	080970202
6*	3	1,6	271,00	1	080970203
6*	4	1,6	322,00	1	080970204
7*	1	2,12	232,50	1	080970221
7*	2	2,12	285,00	1	080970222
7*	3	2,12	334,00	1	080970223
7*	4	2,12	383,00	1	080970224
8*	1	2,8	253,00	1	080970241
8*	2	2,8	312,00	1	080970242
8*	3	2,8	381,00	1	080970243
8*	4	2,8	439,00	1	080970244
10*	1	4,25	384,00	1	080970251
10*	2	4,25	470,00	1	080970252
10*	3	4,25	553,00	1	080970253
10*	4	4,25	639,00	1	080970254
13*	1	7,5	671,00	1	080970331
13*	2	7,5	818,00	1	080970332
13	3	7,5	995,00	1	080970333
13	4	7,5	1.098,00	1	080970334
16	1	11,2	1.325,00	1	080970361
16	2	11,2	1.550,00	1	080970362
16	3	11,2	1.775,00	1	080970363
16	4	11,2	1.930,00	1	080970364
20	2	17,0	3.360,00	1	080970402
20	3	17,0	3.790,00	1	080970403
20	4	17,0	4.220,00	1	080970404

* Geleverd in kunststof koffer

8098

Ketting leng, 4 sprong met grijphaak. In kunststof koffer

CE



EN 818-4

TECHNISCHE DATA

- Veiligheids factor: 4
- Kettingleng identificate label MEEGELEVERDE CERTIFICATEN
- Fabricage Certificaat UNI EN818-4
- CE conformiteits verklaring VERKRIJGBARE CERTIFICATEN
- Technische product specificaties

D mm	L m	WLL ton	€	📄	📦
6*	1	2,36	324,00	1	080980001
6*	2	2,36	398,00	1	080980002
6*	3	2,36	472,00	1	080980003
6*	4	2,36	548,00	1	080980004
7*	1	3,15	380,00	1	080980021
7*	2	3,15	459,00	1	080980022
7*	3	3,15	554,00	1	080980023
7*	4	3,15	652,00	1	080980024
8*	1	4,25	424,00	1	080980041
8*	2	4,25	537,00	1	080980042
8*	3	4,25	653,00	1	080980043
8	4	4,25	799,00	1	080980044
10*	1	6,7	586,00	1	080980051
10	2	6,7	788,00	1	080980052
10	3	6,7	960,00	1	080980053
10	4	6,7	1.132,00	1	080980054
13	1	11,2	986,00	1	080980131
13	2	11,2	1.280,00	1	080980132
13	3	11,2	1.590,00	1	080980133
13	4	11,2	1.865,00	1	080980134
16	1	17	1.985,00	1	080980161
16	2	17	2.430,00	1	080980162
16	3	17	2.880,00	1	080980163
16	4	17	3.330,00	1	080980164
20	2	26,5	4.770,00	1	080980172
20	3	26,5	5.630,00	1	080980173
20	4	26,5	6.480,00	1	080980174

* Houten kist aangepast aan het gewicht

8098SL

Ketting leng, 4 sprong, met zelfsluitende haken en grijphaken, grade 8

CE



EN 818-4

TECHNISCHE DATA

- Veiligheids factor: 4
- Ketting leng identificate label MEEGELEVERDE CERTIFICATEN
- Fabricage Certificaat UNI EN818-4
- CE conformiteits verklaring VERKRIJGBARE CERTIFICATEN
- Technische product specificaties

D mm	L m	WLL ton	€	📄	📦
6*	1	2,36	398,00	1	080980201
6*	2	2,36	487,00	1	080980202
6*	3	2,36	545,00	1	080980203
6*	4	2,36	637,00	1	080980204
7*	1	3,15	479,00	1	080980221
7*	2	3,15	558,00	1	080980222
7*	3	3,15	653,00	1	080980223
7*	4	3,15	751,00	1	080980224
8*	1	4,25	543,00	1	080980241
8*	2	4,25	633,00	1	080980242
8	3	4,25	749,00	1	080980243
8*	4	4,25	895,00	1	080980244
10*	1	6,7	724,00	1	080980251
10	2	6,7	926,00	1	080980252
10	3	6,7	1.098,00	1	080980253
10	4	6,7	1.270,00	1	080980254
13	1	11,2	1.305,00	1	080980331
13	2	11,2	1.600,00	1	080980332
13	3	11,2	1.910,00	1	080980333
13	4	11,2	2.185,00	1	080980334
16	1	17	2.540,00	1	080980361
16	2	17	2.990,00	1	080980362
16	3	17	3.440,00	1	080980363
16	4	17	3.870,00	1	080980364
20	2	26,5	6.700,00	1	080980402
20	3	26,5	7.550,00	1	080980403
20	4	26,5	8.410,00	1	080980404

* Geleverd in kunststof koffer

8100

Hijsketting,
Staallegering met hoge treksterkte

CE

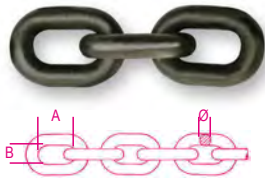

EN 818-2

TECHNISCHE DATA

- Veiligheidsfactor: 4
- Hittebehandeling: gehard en getemperd
- Identificatie code

LABORATORIUM TEST

- Chemische analyse
- Metallografische analyse
- Treksterkte test

VERKRIJGBARE CERTIFICATEN

- Technische Product Specificaties
- Test Rapport UNI EN10204 type 2.2
- Fabrikanten certificaat EN818-2
- CE conformiteits verklaring

WLL	Ø mm	A	B min	€/m	1	081000011
kg	mm	mm	mm			
1120	6	18	7,8	21,50	1	081000011
1500	7	21	11,0	27,50	1	081000016
2000	8	24	12,0	33,00	1	081000020
3150	10	30	14,5	48,50	1	081000032
5300	13	39	20,0	82,50	1	081000053
8000	16	48	20,8	125,50	1	081000080
12500	20	60	26,0	225,00	1	081000125

8085R

Topschalmen,
staallegering met hoge treksterkte

CE



EN 1677-4

TECHNISCHE DATA

- Veiligheidsfactor: 4
- Hittebehandeling: gehard en getemperd
- Identificatie code

LABORATORIUM TESTS

- Chemische analyse, metallografische analyse
- Limietbelasting test (WLL x 2.5)
- Treksterkte test
- Vermoeidheids test (min. 20,000 cycles)

VERKRIJGBARE CERTIFICATEN

- Technische product specificaties
- Test rapport UNI EN10204 type 2.2
- Inspectie certificaat UNI EN10204 type 3.1
- CE conformiteits verklaring

WLL	Ø mm	A	B	€	1	080850215
kg	mm	mm	mm			
1600	7	110	60	11,40	1	080850215
2120	8	110	60	16,20	1	080850220
3150	10	135	75	22,80	1	080850232
5300	13	160	90	40,00	1	080850253
8000	16	180	100	80,00	1	080850280
11200	19	200	110	130,00	1	080850311
16000	20	260	140	214,00	1	080850316
17000	22	300	160	304,00	1	080850317

De werklast is relatief voor gebruik met stroppen met 1 arm. (*) Gecombineerd met ø 6 ketting, WLL = 1120 kg.

8086

Topschalm voor meersprong, staallegering, gelakt.

CE



EN 1677-4

TECHNISCHE DATA

- Veiligheids factor: 4
- Hittebehandeling: gehard en getemperd
- Identificatie code

LABORATORIUM TEST

- Chemische analyse, metallografische analyse
- Limietbelasting test (WLL x 2.5)
- Treksterkte test
- Vermoeidheids test (min. 20,000 cycles)

VERKRIJGBARE CERTIFICATEN

- Technische product specificaties
- Test rapport UNI EN10204 type 2.2
- Inspectie certificaat UNI EN10204 type 3.1
- CE conformiteits verklaring

WLL	Ø mm	B	C	€	1	080860021
kg	mm	mm	mm			
3150	7	135	75	73,50	1	080860021
4250	8	160	90	113,50	1	080860042
6700	10	180	100	146,00	1	080860067
11200	13	200	110	236,50	1	080860100
17000	16	260	140	346,00	1	080860117
21200	18	340	180	619,00	1	080860121
26500	20	350	190	877,00	1	080860126

De werklast geldt voor 3 of 4 armen en een hoek β van minder dan 45°.

(*) In combinatie met ketting ø 6 mm, WLL = 2360 kg.

8090R

Verbindingsschalmen, staallegering, gelakt.

CE

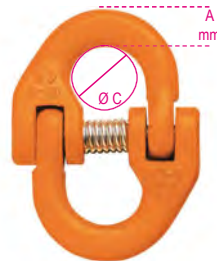

EN 1677-1

TECHNISCHE DATA

- Veiligheids factor: 4
- Hittebehandeling: gehard en getemperd
- Identificatie code

LABORATORIUM TEST

- Chemische analyse, metallografische analyse
- Limietbelasting test (WLL x 2.5)
- Treksterkte test
- Vermoeidheids test (min. 20,000 cycles)

VERKRIJGBARE CERTIFICATEN

- Technische product specificaties
- Test rapport UNI EN10204 type 2.2
- Inspectie certificaat UNI EN10204 type 3.1
- CE conformiteits verklaring

WLL	Ø mm	ØC	A	€	1	080900111
kg	mm	max	mm			
1120	6	13	7,5	9,70	1	080900111
1500	7	18	9	12,50	1	080900115
2000	8	18	11	15,40	1	080900120
3150	10	22	13,0	18,70	1	080900131
5300	13	30	16	34,50	1	080900153
8000	16	32	22	73,50	1	080900180
12500	20	40	25	169,00	1	080900312

8060R

Kettinghaken met gaffel, staallegering, gelakt.

CE



EN 1677-2

TECHNISCHE DATA

- Veiligheids coëfficiënt: 4
- Hittebehandeling: gehard en getemperd
- Identificatie code op de pin, veiligheidsklep en haak

LABORATORIUM TESTEN

- Chemische analyse, metaalgrafische analyse
- Limietbelasting test (WLL x 2.5)
- Treksterkte test
- Vermoeidheids test (min. 20,000 cycli)

VERKRIJGBARE CERTIFICATEN

- Technische product specificaties
- Test rapport UNI EN10204 type 2.2
- Inspectie certificaat UNI EN10204 type 3.1
- CE conformiteits verklaring

WLL	Ø mm	C	€	1	080600111
kg	mm	mm			
1120	6	19	18,20	1	080600111
1500	7	19	19,50	1	080600115
2000	8	21	20,30	1	080600120
3150	10	27	35,50	1	080600132
5300	13	35	56,00	1	080600153
8000	16	48	177,00	1	080600180
12500	20	54	315,00	1	080600225

8058R

Zelfklemmende lasthaken,
Clevis model,
staallegering met hoge treksterkte

CE



EN 1677-3

TECHNISCHE DATA

- Veiligheidsfactor: 4
- Hittebehandeling: gehard en getemperd
- Identificatie code

LABORATORIUM TESTS

- Chemische analyse
- Metallografische analyse
- Treksterkte test
- Vermoeidheids test (20,000 cycles)
- Laad belastings test (100% van de productie)

VERKRIJGBARE CERTIFICATEN

- Technische product specificaties
- Test rapport UNI EN10204 type 2.2
- Inspectie certificaat UNI EN10204 type 3.1
- CE conformiteits verklaring

WLL	Ø mm	J min	€	1	080580112
kg	mm	mm			
1120	6	28	39,00	1	080580112
2000	7-8	34	47,50	1	080580120
3150	10	44	73,50	1	080580132
5300	13	52	146,00	1	080580153
8000	16	67	329,00	1	080580180
12500	20	77	822,00	1	080580225

8061R

Clevis model inkorthaak met veiligheidspin, staallegering met hoge treksterkte

CE



EN 1677-1

TECHNISCHE DATA

- Veiligheidsfactor: 4
- Hittebehandeling: gehard en getemperd
- Identificatie code

LABORATORIUM TESTS

- Chemische analyse
- Metalgrafische analyse
- Treksterkte test
- Vermoeidheids test (20,000 cycles)
- Laad belastings test (100% van de productie)

VERKRIJGBARE CERTIFICATEN

- Technische product specificaties
- Test rapport UNI EN10204 type 2.2
- Inspectie certificaat UNI EN10204 type 3.1
- CE conformiteits verklaring

WLL	Ø mm	E mm	€	🚚	📄
1120	6	8	13,50	1	080610211
2000	7-8	11	15,50	1	080610220
3150	10	13	28,00	1	080610231
5300	13	17	49,50	1	080610253
8000	16	20	111,00	1	080610280
12500	20	24	264,00	1	080610312

8052

Lashaken met oog, Staallegering met hoge treksterkte

CE



EN 1677-2

TECHNISCHE DATA

- Veiligheids factor: 4
- Hittebehandeling: gehard en getemperd
- Identificatie code

LABORATORIUM TESTEN

- Chemische analyse, metalgrafische analyse
- Treksterkte test
- Vermoeidheids test (min. 20,000 cycles)
- Limietbelasting test (2 x WLL)

VERKRIJGBARE CERTIFICATEN

- Technische Product Specificaties
- Test Rapport UNI EN10204 type 2.2
- Inspectie Certificaat UNI EN10204 type 3.1
- CE conformiteits verklaring

WLL	C mm	€	🚚	📄
8052 0,8	800 18	6,90	1	080520008
8052 1,12	1120 22,5	9,25	1	080520011
8052 2	2000 30	19,60	1	080520020
8052 3,15	3150 36	29,50	1	080520031
8052 4	4000 39,5	39,00	1	080520040

8055S 5,4	5400 32	75,50	1	080550145
8055S 8,0	8000 43	131,50	1	080550170
8055S 11,5	11500 53	262,00	1	080550215
8055S 16,0	16000 58	352,00	1	080550260
8055S 22,0	22000 78	826,00	1	080550320

8057R

Zelfklemmende lasthaken, oog model, staallegering met hoge treksterkte

CE



EN 1677-3

TECHNISCHE DATA

- Veiligheidsfactor: 4
- Hittebehandeling: gehard en getemperd
- Identificatie code

LABORATORIUM TESTS

- Chemische analyse
- Metalgrafische analyse
- Treksterkte test
- Vermoeidheids test (20,000 cycles)
- Laad belastings test (100% van de productie)

VERKRIJGBARE CERTIFICATEN

- Technische product specificaties
- Test rapport UNI EN10204 type 2.2
- Inspectie certificaat UNI EN10204 type 3.1
- CE conformiteits verklaring

WLL	Ø mm	J min mm	ØB mm	€	🚚	📄
1120	6	28	22	31,50	1	080570112
2000	7-8	34	25	37,50	1	080570120
3150	10	44	32	67,00	1	080570132
5300	13	54	40	233,50	1	080570153

8063

Wartel haak (in onbelaste uitvoering) Staallegering met hoge treksterkte

CE



EN 1677-1

TECHNISCHE DATA

- Veiligheidsfactor: 4
- Hittebehandeling: gehard en getemperd
- Identificatie code

LABORATORIUM TESTS

- Chemische analyse • Metalgrafische analyse
- Treksterkte test
- Vermoeidheids test (20,000 cycles)
- Laad belastings test (100% van de productie)

VERKRIJGBARE CERTIFICATEN

- Technische product specificaties
- Test rapport UNI EN10204 type 2.2
- Inspectie certificaat UNI EN10204 type 3.1
- CE conformiteits verklaring

WLL	A mm	E mm	€	🚚	📄
800	32	20,5	15,50	1	080630008
1120	38	20,5	19,50	1	080630011
2000	44,5	22	23,70	1	080630020
3150	44,5	27	29,00	1	080630031

8063SL

zelfsluitende draaibare haken (niet onder belasting) gelegeerd staal met hoge treksterkte grade 8

CE

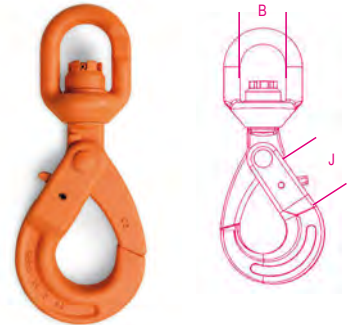

EN 1677-1

TECHNISCHE GEGEVENS

- veiligheidsfactor: 4
- warmtebehandeling: harden en ontlaten
- traceerbaarheidscode

LABORATORIUM TESTS

- chemische analyse, metallografische analyse
- trektest
- vermoeidheidstest (min. 20.000 cycli)
- laadtest (alle units)

BESCHIKBARE CERTIFICATEN

- Technische productspecificaties
- Testrapport UNI EN10204 type 2.2
- Keuringscertificaat UNI EN10204 type 3.1
- CE-verklaring van overeenstemming

WLL	Ø mm	B mm	J mm	€	🚚	📄
1120	6	32	45	40,50	1	080630311
2000	8	35	59	56,50	1	080630320
3150	10	42	54	98,00	1	080630331
5300	13	49	83	149,50	1	080630353

8064S

Wartelhaak, koolstofstaal, gelakt.

CE

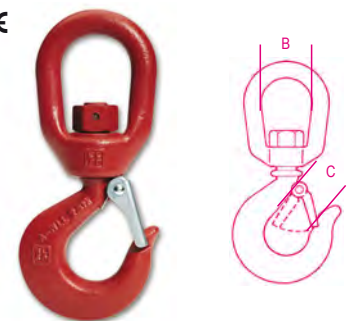

EN 1677-5

TECHNISCHE DATA

- Veiligheids factor: 45
- Hittebehandeling: gehard en getemperd
- Identificatie code

LABORATORIUM TEST

- Chemische analyse, metalgrafische analyse
- Limietbelasting test (WLL x 2.5)
- Treksterkte test

- Vermoeidheids test (min. 20,000 cycles)

VERKRIJGBARE CERTIFICATEN

- Technische product specificaties
- Test rapport UNI EN10204 type 2.2
- Inspectie certificaat UNI EN10204 type 3.1
- CE conformiteits verklaring

WLL	B mm	C mm	€	🚚	📄
800	31	20	38,00	1	080640107
1000	40	22	53,50	1	080640110
1600	47	23	69,50	1	080640115
2000	47	27	76,00	1	080640120
3200	64	35	132,50	1	080640130
5000	77	43	242,50	1	080640150
7500	90	53	353,00	1	080640175
10000	96	58	587,00	1	080640199

8065SC

Wartelhaken, koolstofstaal, gelakt

CE



EN 1677-5

TECHNISCHE DATA

- Veiligheids factor: 5
- Hittebehandeling: gehard en getemperd
- Identificatie code

LABORATORIUM TEST

- Chemische analyse, metalgrafische analyse
- Limietbelasting test (WLL x 2,5)
- Treksterkte test

VERKRIJGBARE CERTIFICATEN

- Technische product specificaties
- Test rapport UNI EN10204 type 2.2
- Inspectie certificaat UNI EN10204 type 3.1
- CE conformiteits verklaring

WLL kg	B mm	C mm	€	📦	🖨️
800	38	20	75,50	1	080650107
1000	38	22	82,00	1	080650110
1600	47	23	102,00	1	080650115
2000	47	27	116,50	1	080650120
3200	54	35	204,50	1	080650130
5000	72	43	303,00	1	080650150
7500	82	53	513,00	1	080650175

8062

Stalen Kettinghaken

CE

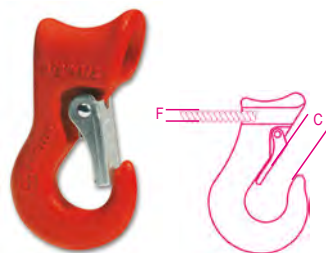

TECHNISCHE DATA

- Veiligheids factor: 5
- Hittebehandeling: gehard en getemperd
- Identificatie code

LABORATORIUM TEST

- Chemische analyse, metalgrafische analyse
- Limietbelasting test (WLL x 2,5)
- Treksterkte test

VERKRIJGBARE CERTIFICATEN

- Technische product specificaties
- Test rapport UNI EN10204 type 2.2
- Inspectie certificaat UNI EN10204 type 3.1
- CE conformiteits verklaring

WLL kg	C mm	F mm	€	📦	🖨️
1500	19	10-13	46,00	1	080620013
2000	21	16	64,50	1	080620016
3000	26	18	107,50	1	080620018

8051S

Lasthaken, koolstofstaal, gegalvaniseerd

CE



TECHNISCHE DATA

- Veiligheids factor: 4
- Hittebehandeling: genormaliseerd
- Identificatie code

LABORATORIUM TEST

- Chemische analyse
- Metalgrafische analyse
- Treksterkte test
- VERKRIJGBARE CERTIFICATEN
- Technische product specificaties
- Test rapport UNI EN10204 type 2.2
- Inspectie certificaat UNI EN10204 type 3.1
- CE conformiteits verklaring

WLL kg	C mm	F mm	€	📦	🖨️
250	14	12	3,40	10	080510202
500	18	16,5	7,35	5	080510205

Speciale service verpakking



WLL kg	📦	€	📦	🖨️
250	1	4,75	1	080519202
500	1	9,15	1	080519205

8134

Magnetische lifters

CE

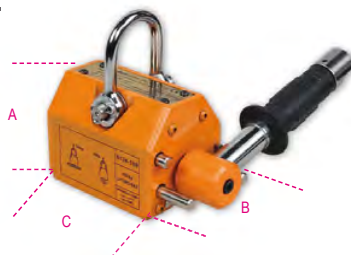

EN13155

Technische data:

- Veiligheidsfactor: 3
- Identificatie bewijs

Beschikbare certificaten:

- Certificaat van de fabrikant
- Verklaring van conformiteit met machinerichtlijn 2006/42/EC
- Testrapport Uni EN10204 Type 2.2
- Handleiding voor bediening en onderhoud

WLL kg	A mm	B mm	C mm	€	📦	🖨️
100	70	64	92	473,00	1	081340010
300	96	88	165	830,00	1	081340030
600	120	118	236	1.545,00	1	081340060
1000	168	168	264	2.560,00	1	081340100

8135

Platenklemmen met een maximale hardheid van 30HRC/300HB met scharnierende hijsogen

CE



EN13155

TECHNISCHE DATA

- Veiligheidsfactor: 3
- Typeplaat met serienummer
- VERKRIJGBARE CERTIFICATEN
- Certificaat van de fabrikant
- CE conformiteits verklaring
- Test rapport UNI EN10204 type 2.2
- Technische product specificaties

WLL t	A mm	E mm	📦	kg	€	📦	🖨️
0,75	0-15	2	2	136,50	1	081350005	
1,0	0-20	5	5	185,00	1	081350010	
2,0	0-25	8	8	276,00	1	081350020	
3,0	0-30	15	15	466,00	1	081350032	
5,0	0-50	23	23	656,00	1	081350050	

8143

Kettingtakel

CE



EN13157

Certificato TUV

WLL t	📦	storz / effort Lm	kg	€	📦	🖨️
0,5	3	27	221,50	1	081430005	
1	3	44	261,00	1	081430010	
1,5	3	44	260,00	1	081430015	
2	3	44	380,00	1	081430020	
3	3	45	489,00	1	081430030	
5	3	47	726,00	1	081430050	

0,5	6	27	331,00	1	081430105
1	6	44	373,00	1	081430110
1,5	6	44	360,00	1	081430115
2	6	44	525,00	1	081430120
3	6	45	750,00	1	081430130
5	6	47	1.064,00	1	081430150

8146

Kettingtakel

CE



EN13157
Certificato TUV

WLL t	L m	sforzo / effort kg	€		
0,75	1,5	21*	270,00	1	081460008
1,5	1,5	41*	385,00	1	081460015
3,0	1,5	41	514,00	1	081460030
6,0	1,5	46	834,00	1	081460060
0,75	3,0	21*	303,00	1	081460108
1,5	3,0	41*	427,00	1	081460115
3,0	3,0	41	590,00	1	081460130
6,0	3,0	46	1.000,00	1	081460160

8146C

Kettingtakel, compact model

CE

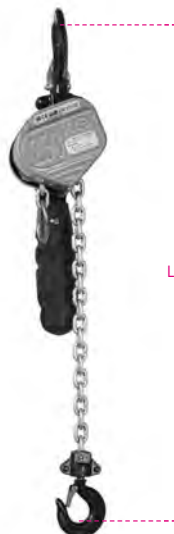

EN13157
Certificato TUV

WLL t	L m	sforzo / effort kg	€		
0,25	1,5	20,7	248,50	1	081460002

8147C

ankerpennen
voor handmatige lieren 8148

geschikt voor constructie balken (INP, IPB, IPE, HEA, HEB etc.)

CE



EN 13157

Technische data:
Veiligheidsfactor: 4
• Identificatie bewijs

Beschikbare certificaten:
• Certificaat van de fabrikant
• CE-verklaring van overeenstemming
• Testrapport UNI EN10204 type 2.2
Technische productspecificaties

WLL t	L min mm	L max mm	Lm	€		
1,0	58	220	3	277,00	1	081470510
2,0	66	220	3	353,00	1	081470520
3,0	74	220	3	540,00	1	081470530
5,0	90	220	3	745,00	1	081470550

Artikel gedemonteerd geleverd: het moet voor gebruik worden gemonteerd in overeenstemming met de gebruiksaanwijzing.

8147S

set van 2 handgreepkappen
voor handmatige lieren 8148

geschikt voor constructie balken (INP, IPB, IPE, HEA, HEB etc.)

CE



EN 13157

Technische data:
Veiligheidsfactor: 4
• Identificatie bewijs

Beschikbare certificaten:
• Certificaat van de fabrikant
• CE-verklaring van overeenstemming
• Testrapport UNI EN10204 type 2.2
Technische productspecificaties

WLL t	L min mm	L max mm	øF mm	€		
0,5	50	220	25	177,50	1	081470005
1,0	58	220	30	227,50	1	081470010
2,0	66	220	40	290,00	1	081470020

Artikel gedemonteerd geleverd: het moet voor gebruik worden gemonteerd in overeenstemming met de gebruiksaanwijzing.

8147P

set van 2 beschermhoezen
voor handmatige lieren 8148

geschikt voor constructie balken (INP, IPB, IPE, HEA, HEB etc.)

CE

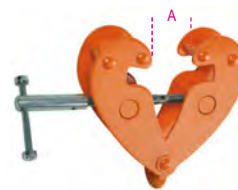

Technische data:
Veiligheidsfactor: 4
• Identificatie bewijs

Beschikbare certificaten:
• Certificaat van de fabrikant
• CE-verklaring van overeenstemming
• Testrapport UNI EN10204 type 2.2
Technische productspecificaties

WLL t	A min mm	A max mm	€		
1,0	90	180	117,50	1	081470210
2,0	90	190	142,00	1	081470220
3,0	85	280	239,00	1	081470230
5,0	85	280	349,00	1	081470250

 **Robur**

 **Robur**

8148

Handlier, behuizing van aluminium legering. Compleet met bedieningshendel, touw en haak

Lichtgewicht en draagbaar, de ROBUR-handlier voldoet aan EN 13157, is gemaakt van hoogwaardige materialen en is geschikt voor het heffen, trekken, spannen en bevestigen van belastingen in alle richtingen via de bedieningshendel. Over het algemeen verbonden met een vast punt, zorgt het voor zeer nauwkeurige laadpositionering en zorgt voor een veilige werking in alle richtingen - horizontaal, verticaal en gekanteld. Op basis van het compacte, handige ontwerp is het eenvoudig te installeren en te gebruiken. De Robur-handlier maakt het mogelijk om touwen in elke lengte te gebruiken, en de capaciteit ervan kan worden verhoogd met een factor van 2, 3, 4 of meer - op voorwaarde dat het frame wordt geïnspecteerd -, door gebruik te maken van geleidingsrollen en haken met blokken volgens de referentienorm.

CE



EN 13157

• Veiligheidsfactor: 4: 1

WLL t	L m	A mm	ø f mm	€		
0,8	20	426	8,3	398,00	1	081480008
1,6	20	545	11	622,00	1	081480016
3,2	20	660	16	1.023,00	1	081480032

0,8	30	426	8,3	443,00	1	081480108
1,6	30	545	11	690,00	1	081480116
3,2	30	660	16	1.150,00	1	081480132

0,8	50	426	8,3	479,00	1	081480308
1,6	50	545	11	747,00	1	081480316
3,2	50	660	16	1.250,00	1	081480332

8148F

kabel gemaakt van gegalvaniseerd staal gewonden op een geleidingsrol met hoge treksterkte-haak

CE



WLL t	L m	ØF mm	€		
0,8	20	8,3	108,00	1	081480520
1,6	20	11	170,50	1	081480521
3,2	20	16	331,00	1	081480523

0,8	30	8,3	153,00	1	081480530
1,6	30	11	238,50	1	081480531
3,2	30	16	458,00	1	081480533

0,8	50	8,3	189,00	1	081480550
1,6	50	11	295,00	1	081480551
3,2	50	16	560,00	1	081480553

8120

Genovese ketting voor statische verbindingen, gegalvaniseerd



TECHNISCHE DATA

- Veiligheids factor: 4
- VERKRIJGBARE CERTIFICATEN
- Technische product specificaties
- Test rapport UNI EN10204 type 2.2

Ø mm	nr	WFL kg	m	€		
1,5	10	8	150	209,00	1	081200015
1,6	12	15	150	217,50	1	081200016
2,2	14	25	75	127,50	1	081200022
2,7	16	40	75	157,50	1	081200027
3,0	17	55	75	174,00	1	081200030
3,4	18	100	60	177,00	1	081200034
3,8	19	110	50	171,50	1	081200038
4,4	20	200	40	159,00	1	081200044
4,8	21	250	30	151,50	1	081200048
5,5	22	300	25	151,50	1	081200055
5,8	23	310	25	171,50	1	081200058
6,5	24	400	25	194,50	1	081200065
7,0	25	450	25	236,50	1	081200070
7,5	26	550	20	211,50	1	081200075
* 8,0	27	600	25	306,00	1	081200080
* 9,0	28	800	25	385,00	1	081200090
* 10,0	30	1000	20	389,00	1	081200100
* 12,0	32	1400	15	412,00	1	081200120

Opgelet: product IS NIET geschikt voor hef toepassingen

(*) beschikbaar in rollen

8120B

Genovese ketting voor statische verbinding, gegalvaniseerd



TECHNISCHE DATA

- Veiligheids factor: 4
- VERKRIJGBARE CERTIFICATEN
- Product specificaties
- Test rapport type 2.2 UNI EN10204

Ø mm	nr	WFL kg	m	€		
1,5	10	8	200	260,00	1	081200315
1,6	12	15	200	276,00	1	081200316
2,2	14	25	100	162,50	1	081200322
2,7	16	40	100	208,00	1	081200327
3,0	17	55	75	173,50	1	081200330
3,4	18	100	100	277,00	1	081200334
3,8	19	110	75	245,00	1	081200338
4,4	20	200	50	189,00	1	081200344
4,8	21	250	50	245,00	1	081200348
5,5	22	300	40	234,50	1	081200355
5,8	23	310	30	201,00	1	081200358
6,5	24	400	30	228,50	1	081200365
7,0	25	450	25	230,50	1	081200370
7,5	26	550	25	255,00	1	081200375
8,0	27	600	15	196,50	1	081200380
9,0	28	800	15	232,00	1	081200390
10,0	30	1000	10	190,00	1	081200400
12,0	32	1400	8	219,50	1	081200420

Opgelet: NIET geschikt voor heffen

8121MZC

Genovese kettingen, voor statische verbindingen thermisch verzinkt



BESCHIKBARE CERTIFICATEN

- Productspecificatie
- Testrapport UNI EN10204 type 2.2

Ø mm	nr	WFL kg	m	€		
6,0	23	310	50	360,00	1	081210306
8,0	27	600	50	600,00	1	081210308
10,0	30	1000	50	950,00	1	081210310
12,0	32	1400	50	1.375,00	1	081210312
14,0	34	1800	50	1.950,00	1	081210314

8120D

gekalibreerde kettingen DIN766 elektrolytisch verzinkt op aanvraag in elke lengte leverbaar (>30m)



TECHNISCHE GEGEVENS

- veiligheidscoëfficiënt: 4
- BESCHIKBARE CERTIFICATEN
- Technische product specificaties
- Testrapport UNI EN10204 type 2.2

Ø mm	P mm	WFL kg	m	€		
4	16	200	30	130,50	1	081200640
5	18,5	320	30	184,00	1	081200650
6	18,5	400	30	280,00	1	081200660
7	22	630	30	335,00	1	081200670
8	24	800	30	444,00	1	081200680
10	28	1250	30	677,00	1	081200700

gekalibreerde kettingen DIN766 Thermisch verzinkt

Ø mm	P mm	WFL kg	m	€		
4	16	200	30	162,50	1	081200840
5	18,5	320	30	222,50	1	081200850
6	18,5	400	30	330,00	1	081200860
7	22	630	30	388,00	1	081200870
8	24	800	30	515,00	1	081200880
10	28	1250	30	779,00	1	081200900

8129

Afbaken ketting, vervaardigd uit gegalvaniseerd metaal, gelakt in rood en wit



Ø mm	m	€		
5	30	277,00	1	081290050

Waarschuwing: NIET voor heffen of vastzetten

8130

Anti diefstal ketting, vervaardigd uit staallegering, gehard en getemperd, gegalvaniseerd



Ø mm	L mm	€		
6	800	16,70	1	081300068
8	1000	36,50	1	081300081
8	1200	41,00	1	081300082
10	1500	62,50	1	081300105

8074

Karabijnhaken gegalvaniseerd



DIN 5299 tipo C

TECHNISCHE DATA

- Veiligheids factor: 4
- VERKRIJGBARE CERTIFICATEN
- Technische product specificaties
- Test rapport UNI EN10204 type 2.2

DxL mm	A mm	WFL kg	€		
* 4x40	6	20	0,69	100	080740040
5x50	7	30	0,70	100	080740050
6x60	8	40	0,77	100	080740060
7x70	9	60	0,98	50	080740070
8x80	11	75	1,19	50	080740080
9x90	12	100	1,61	25	080740090
10x100	13	120	2,18	25	080740100
11x120	16	140	2,93	20	080740101
12x140	22	140	4,10	15	080740102
13x160	24	200	5,65	10	080740103
* 14x180	32	250	11,80	5	080740104

speciale pakken



DxL mm	A mm	€		
6x60	8	50	43,50	1 080740760
7x70	9	25	27,50	1 080740770
8x80	11	25	33,50	1 080740780
9x90	12	15	27,00	1 080740790
10x100	13	15	36,50	1 080740800
11x120	16	10	33,00	1 080740801
12x140	22	10	46,00	1 080740802

8074A

Karabijnhaken gegalvaniseerd



DIN 5299 tipo A

TECHNISCHE DATA

- Veiligheids factor: 4
- VERKRIJGBARE CERTIFICATEN
- Technische product specificaties
- Test rapport UNI EN10204 type 2.2

øAxL mm	D mm	WFL kg	€		
5x50	7,4	30	0,94	50	080740405
6x60	8,7	40	1,09	50	080740406
8x80	10,5	75	1,47	25	080740408
10x100	13,3	120	2,59	10	080740410

8074G

Karabijn haken met borgring gegalvaniseerd

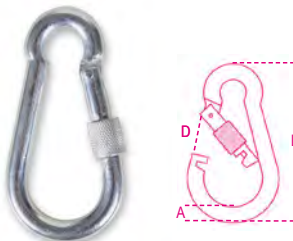

TECHNISCHE DATA

- Veiligheids factor: 4
- VERKRIJGBARE CERTIFICATEN
- Technische product specificaties
- Test rapport UNI EN10204 type 2.2

øAxL mm	D mm	WFL kg	€		
5x50	7,5	30	1,05	50	080740305
6x60	8,5	40	1,21	50	080740306
8x80	10,3	75	1,61	25	080740308
10x100	10,6	120	2,71	10	080740310

8080

Snelsluiters gegalvaniseerd



TECHNISCHE DATA

- Veiligheids factor: 4
- VERKRIJGBARE CERTIFICATEN
- Technische product specificaties
- Test rapport UNI EN10204 type 2.2

DxL mm	A mm	WFL kg	€		
3,5x36	5	20	0,56	100	080800003
4x40	6	30	0,60	100	080800004
5x49	6	50	0,73	100	080800005
6x57	8	60	0,91	100	080800006
7x66	8	100	1,19	50	080800007
8x74	11	140	1,41	50	080800008
9x80	11	160	2,02	25	080800009
10x89	11	220	2,38	25	080800010
12x105	15	300	4,10	20	080800012
14x122	16,5	400	8,85	3	080800014

8080FM

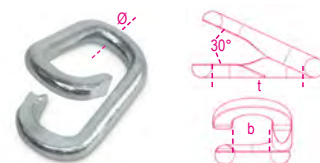

TECHNISCHE GEGEVENS

- veiligheidscoëfficiënt: 4
- BESCHIKBARE CERTIFICATEN
- Technische product specificaties
- Testrapport UNI EN10204 type 2.2

M	ød mm	b mm	t mm	€		
4	3,8	8,6	21,5	0,44	100	080800204
5	4,7	11,1	25,8	0,72	50	080800205
6	5,3	13,8	32,0	1,39	30	080800206
7	6,5	16,8	37,0	1,65	10	080800207
8	8,0	18,0	38,0	2,43	10	080800208

8082

Topshalm gegalvaniseerd staal

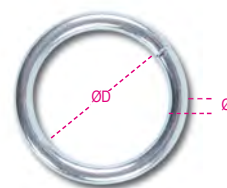

Ø mm	ØD mm	WFL kg	€		
4	20	75	0,42	50	080820004
5	30	125	0,56	20	080820005
6	40	185	0,91	10	080820006
7	50	265	1,41	5	080820007
8	60	350	1,88	5	080820008

8083

S-haken
gegalvaniseerd staal



Ø mm	L mm	WFL kg	€		
3	33	4	0,09	100	080830003
4	40	5	0,13	60	080830004
5	47	12	0,24	50	080830005
6	59	18	0,44	30	080830006
8	79	33	1,10	10	080830008

8114

Oogmoer met wartel
verzinkt

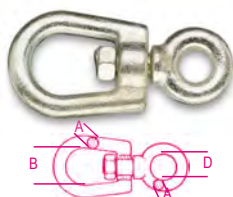

TECHNISCHE DATA

- veiligheidsfactor: 4
- traceerbaarheidscode

LABORATORIUM TESTEN

- trekproef

BESCHIKBARE CERTIFICATEN

- Technische product specificaties
- Testrapport UNI EN10204 type 2.2
- Keuringscertificaat UNI EN10204 type 3.1

A mm	B mm	D mm	WFL kg	€		
8	30	16	250	4,50	10	081140008
10	38	18	300	8,25	10	081140010
12	42	20	650	11,90	5	081140012
14	48	22	820	18,50	5	081140014
16	57	24	1000	25,50	3	081140016
18	64	26	1600	30,00	3	081140018
20	72	30	2000	43,00	1	081140020
22	80	34	2500	59,50	1	081140022

8116

Oogmoer met wartel
verzinkt

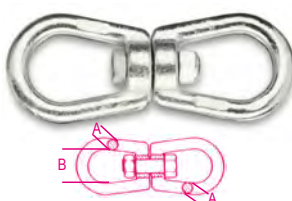

TECHNISCHE DATA

- veiligheidsfactor: 4
- traceerbaarheidscode

LABORATORIUM TESTEN

- trekproef

BESCHIKBARE CERTIFICATEN

- Technische product specificaties
- Testrapport UNI EN10204 type 2.2
- Keuringscertificaat UNI EN10204 type 3.1

A mm	B mm	WFL kg	€		
6	23	140	4,80	10	081160006
8	30	250	5,95	10	081160008
10	38	300	10,90	5	081160010
12	42	650	17,90	5	081160012
14	48	820	26,50	3	081160014
16	57	1000	34,00	3	081160016
18	64	1600	40,50	1	081160018
20	72	2000	57,50	1	081160020
22	80	2500	89,00	1	081160022

8317SZ

Duplex staalraadklemmen, gegalvaniseerd

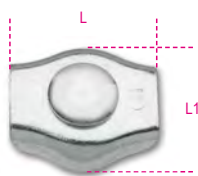

VERKRIJGBARE CERTIFICATEN

- Test rapport UNI EN10204 type 2.2

Ø mm	L mm	L1 mm	€		
2	15	14	0,27	100	083170102
3	18	16	0,28	100	083170103
4	20	19	0,39	100	083170104
5	24	23	0,45	50	083170105
6	30	27	0,54	30	083170106
8	36	34	1,02	20	083170108
10	42	37	1,54	10	083170110

8317DZ

Duplex staalraadklemmen, gegalvaniseerd



VERKRIJGBARE CERTIFICATEN

- Test rapport UNI EN10204 type 2.2

Ø mm	L mm	L1 mm	€		
2	30	14	0,35	50	083170002
3	35	15	0,48	50	083170003
4	40	18	0,56	50	083170004
5	50	21	0,71	25	083170005
6	60	25	0,94	20	083170006
8	76	33	2,02	10	083170008
10	95	37	3,05	10	083170010

8381SL

U-bouten voor buizen, lichte uitvoering,
gegalvaniseerd

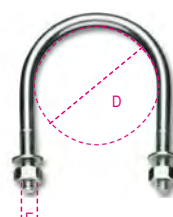

VERKRIJGBARE CERTIFICATEN

- Technische product specificaties
- Test rapport UNI EN10204 type 2.2

D mm	D gas	E mm	€		
11	1/8"	M6	0,56	100	083810201
14	1/4"	M6	0,60	100	083810202
18	3/8"	M6	0,60	100	083810203
22	1/2"	M6	0,69	100	083810204
27	3/4"	M6	0,69	100	083810205
34	1"	M6	0,75	100	083810206
43	1 1/4"	M6	0,75	100	083810207
49	1 1/2"	M8	1,34	50	083810208
61	2"	M8	1,41	50	083810209
77	2 1/2"	M8	1,67	25	083810210
89	3"	M8	1,79	25	083810211
102	3 1/2"	M8	2,02	25	083810212
115	4"	M8	2,24	25	083810213
140	5"	M8	4,90	25	083810215
168	6"	M10	5,35	25	083810218
220	8"	M10	10,90	10	083810220

8381SP

U-bouten voor buizen, zware uitvoering,
gegalvaniseerd

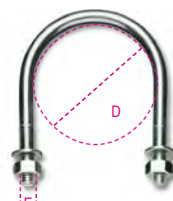

VERKRIJGBARE CERTIFICATEN

- Technische product specificaties
- Test rapport UNI EN10204 type 2.2

D mm	D gas	E mm	€		
22	1/2"	M8	0,98	100	083810301
27	3/4"	M8	1,07	100	083810302
34	1"	M8	1,16	100	083810303
43	1 1/4"	M8	1,25	100	083810304
49	1 1/2"	M10	2,10	25	083810305
61	2"	M10	2,30	25	083810306
77	2 1/2"	M10	2,65	25	083810307
89	3"	M10	2,79	25	083810308
102	3 1/2"	M12	4,50	25	083810309
115	4"	M12	4,90	15	083810310
140	5"	M12	7,65	15	083810312
168	6"	M16	12,80	15	083810315
220	8"	M16	22,50	10	083810320
274	10"	M16	23,70	1	083810374
274	10"	M20	34,50	1	083810375
324	12"	M20	72,00	1	083810386
408	16"	M24	106,50	1	083810508

Robur

Robur

8383C

Vierkante U bouten,
heet gegalvaniseerd
Verzonken moeren

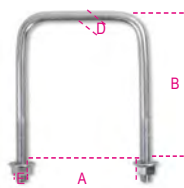

VERKRIJGBARE CERTIFICATEN
• Technische Product Specificaties
• Test Rapport UNI EN10204 type 2.2

A mm	E mm	B mm	D mm	€		
70	M10	110	8,55	2,24	130	083830070
80	M10	120	8,55	2,59	110	083830080
90	M10	130	8,55	2,79	100	083830090
100	M10	155	8,55	3,40	90	083830100
120	M10	175	8,55	3,90	70	083830120

8383P

Klempaten voor U bouten. Heet
gegalvaniseerd

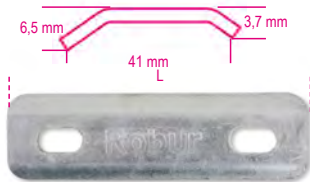

VERKRIJGBARE CERTIFICATEN
• Test rapport UNI EN10204 type 2.2

	L mm	€		
8383P 150 8383C/70-80 /90-100	150	2,79	150	083830214
8383P 170 8383C/100-120	170	3,40	120	083830217

8515Z

Draadtrekkers voor landbouw
gegalvaniseerd

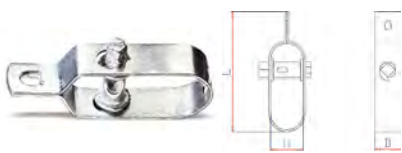

D mm	H mm	L mm	€		
20	25	93	1,47	50	085150002
24,5	30	100	2,02	50	085150003

8515V

Draadtrekkers voor landbouw
gegalvaniseerd en gelakt



D mm	H mm	L mm	€		
20	25	93	1,95	50	085150102
24,5	30	100	2,46	50	085150103

8515CH

Draadtrekker sleutel,
gegalvaniseerd



L mm	OA mm	OB mm	€		
90	8	7,5	0,71	20	085150901

8531

D-sluitingen type voor visserij gegalvaniseerd

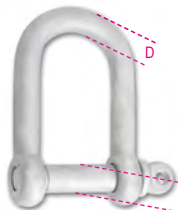

VERKRIJGBARE CERTIFICATEN
• Test rapport UNI EN10204 type 2.2

Ø mm	D mm	WFL kg	€		
20	18	1600	20,10	1	085310018
22	20	2500	29,00	1	085310020

8532

D-sluitingen type voor visserij zwart gelakt

pin met inw. vierkant



VERKRIJGBARE CERTIFICATEN
• Test rapport UNI EN10204 type 2.2

Ø mm	D mm	WFL kg	€		
20	20	1600	9,90	1	085320020
22	22	2500	15,20	1	085320022

8535

Haken type vishaak
gegalvaniseerd

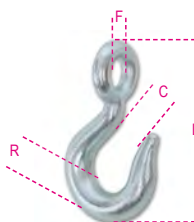

VERKRIJGBARE CERTIFICATEN
• Test rapport UNI EN10204 type 2.2

R mm	C mm	F mm	L mm	€		
26	27,5	34	156	22,50	1	085350006
30	36,5	40	185	30,50	1	085350007

8050 D1÷D45

safety locks and spare parts kit for eye hooks



	€		
8050D1 8064S-8065SC/800-8055S/1250	8,75	1	080500945
8050D2 8064S-8065SC/1000 8062/1500-8055S/1600	10,20	1	080500946
8050D3 8064S-8065SC/1600-2000 8055S/2500-3200	11,00	1	080500947
8050D4 8064S-8065SC/3200-8055S/5400	18,20	1	080500948
8050D5 8064S-8065SC/5000-8055S/8000	21,00	1	080500949
8050D6 8064S/7500-8055S/11500	34,00	1	080500950
8050D11 8062/2000	17,40	1	080500955
8050D12 8062/3000	19,20	1	080500956
8050D13 8062/5000	35,00	1	080500957
8050D22 8064S/10000 8055S/16000	46,00	1	080500966
8050D23 8055S/22000	63,00	1	080500967
8050D24 8051S/250	0,80	1	080500969
8050D25 8051S/500	0,95	1	080500970
8050D30 8061F/8000	25,50	1	080500975
8050D32 8060/8000	35,50	1	080500977
8050D 33 8052/800	3,55	1	080500978
8050D 34 8052/1120	3,95	1	080500979
8050D 35 8052/2000	4,85	1	080500980
8050D 36 8052/3150	5,25	1	080500981
8050D 37 8052/4000	6,20	1	080500982
8050D38 8060R/1120	2,29	1	080500983
8050D53 8060R/1500	3,10	1	080500994
8050D39 8060R/2000	3,10	1	080500984
8050D40 8060R/3150	5,45	1	080500985
8050D41 8060R/5300	8,35	1	080500986
8050D42 8063/800	0,80	1	080500987
8050D43 8063/1120	1,15	1	080500988
8050D44 8063/2000	1,49	1	080500989
8050D45 8063/3150	1,82	1	080500990



8050D46 8061R/1120	2,38	1	080500991
8050D47 8061R/2000	2,38	1	080500992
8050D48 8061R/3150	3,30	1	080500993
8050D54 8061R/5300	3,30	1	080500995



8050D49 8057R - 8058R - 8063SL /1120	6,55	1	080500849
8050D50 8057R - 8058R - 8063SL /2000	7,10	1	080500850
8050D51 8057R - 8058R - 8063SL /3150	7,80	1	080500851
8050D52 8057R - 8058R - 8063SL /5300	17,50	1	080500852

8058R/PS

Kit met pennen voor haken artikel
8058R-8061R



	Ø mm	€		
8058R/PS 1,12	6	7,65	1	080580512
8058R/PS 2,0	7-8	8,75	1	080580520
8058R/PS 3,15	10	17,50	1	080580532
8058R/PS 5,3	13	29,50	1	080580553

8060R/PS

Kit met pennen voor haken artikel 8060R



	Ø mm	€		
8060R/PS 1,12	6	7,65	1	080600511
8060R/PS 1,5	7	8,75	1	080600515
8060R/PS 2,0	8	8,75	1	080600520
8060R/PS 3,15	10	17,50	1	080600532
8060R/PS 5,3	13	29,50	1	080600553

8135/KLA1

bedieningshendel kit
voor hijsklemmen 8135



8135 t	€		
0,75	17,00	1	081350605
1,00	20,90	1	081350610
2,00	24,20	1	081350615
3,00	29,00	1	081350620
5,00	45,50	1	081350625

De verantwoordelijkheid voor reparaties ligt bij de
reparateur.

8135/KMO

veerset voor hijsklemmen 8135



8135 t	€		
0,75	7,55	1	081350655
1,00	10,90	1	081350660
2,00	14,20	1	081350665
3,00	18,30	1	081350670
5,00	27,00	1	081350675

De verantwoordelijkheid voor reparaties ligt bij de
reparateur.

8143/RKL

Set van bovenste en onderste haaksluitingen
voor handkettingtakels 8143



8143 WLL t	€		
0,5	1,53	1	081430500
1,0	1,76	1	081430501
2,0	2,64	1	081430502
3,0	3,10	1	081430503
5,0	3,65	1	081430504

8143/RPC

set haakketting blok pinnen
voor handkettingtakels 8143



8143 WLL t	€		
0,5	1,82	1	081430510
1,0	2,49	1	081430511
2,0	2,69	1	081430512
3,0	4,45	1	081430513
5,0	4,80	1	081430514

8143/RPF

Set stop-pennen
voor handkettingblokken 8143



8143 WLL t	€		
0,5	0,83	1	081430520
1,0	0,89	1	081430521
2,0	1,24	1	081430522
3,0	0,98	1	081430523
5,0	1,53	1	081430524

8143/RKCI

Set met onderste haken
voor handkettingtakels 8143



8143 WLL t	€		
0,5	11,70	1	081430560
1,0	15,50	1	081430561
2,0	28,50	1	081430562
3,0	94,00	1	081430563
5,0	129,50	1	081430564

8146/RK

Veiligheidsslot, pinnen en pallen
voor kettingtakels 8146C-8146



8146C WLL t	€		
0,25	5,85	1	081460902

8146/RKL

Set van bovenste en onderste haaksluitingen
voor hefboomtakels 8146



8146 WLL t	€		
0,75	1,76	1	081460500
1,5	2,01	1	081460501
3,0	3,10	1	081460502
6,0	3,55	1	081460503

8146/RPC

set haakketting blok pinnen
voor hefboomtakels 8146



8146 WLL t	€		
0,75	1,82	1	081460510
1,5	2,69	1	081460511
3,0	2,84	1	081460512
6,0	2,84	1	081460513

8146/RKFC

Stop-set
voor hefboomtakels 8146



8146 WLL t	€		
0,75	4,85	1	081460520
1,5	6,15	1	081460521
3,0	6,60	1	081460522
6,0	7,80	1	081460523

 Robur

 Robur

8146/RKCI

set met onderste haken voor hefboomtakels 8146



8146 WLL t	€		
0,75	13,40	1	081460560
1,5	28,50	1	081460561
3,0	94,00	1	081460562
6,0	177,50	1	081460563

8148/RA

dwaarsstuk voor staalkabels van handmatige touwlieren 8148



8148 t	€		
0,8	21,40	1	081480900
1,6	28,50	1	081480901
3,2	37,50	1	081480902

8148/RKS

set van 3 breekpennen voor overbelasting voor handmatige lieren 8148



8148 t	€		
0,8	3,95	1	081480903
1,6 - 3,2	4,95	1	081480904

8148/RKCM

set van 2 handgreepkappen voor handmatige lieren 8148



8148/RKCM	€		
	1,79	1	081480905

8148/RKCL

set van 2 hendeldoppen voor handmatige lieren 8148



8148/RKCL	€		
	1,91	1	081480906

8148/RP

ankerpennen voor handmatige lieren 8148



8148 t	€		
0,8	16,40	1	081480907
1,6	22,00	1	081480908
3,2	27,50	1	081480909

8148/RKG

set van 2 beschermhoezen voor handmatige lieren 8148



8148 t	€		
0,8	17,00	1	081480910
1,6	19,30	1	081480911
3,2	20,30	1	081480912

8149

kettingen voor kettingblokken

CE

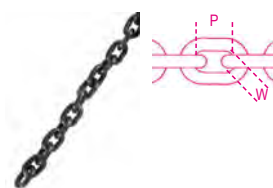

EN 818-7

TECHNISCHE DATA

- Veiligheidsfactor: 4
- Hittebehandeling: gehard en getemperd
- Identificatie code

LABORATORIUM TEST

- Chemische analyse
- Metallografische analyse
- Treksterkte test

VERKRIJGBARE CERTIFICATEN

- Technische Product Specificaties
- Test Rapport UNI EN10204 type 2.2
- CE conformiteits verklaring

Ø mm	WLL Kg	P mm	W min	€/m		
4	500	12	4,8	16,20	1	081490012
5	800	15	6,0	19,90	1	081490015
6	1100	18	7,2	22,30	1	081490018
6,3	1200	19	7,6	24,70	1	081490019
8	2000	24	9,6	34,00	1	081490024
10	3200	30	12	52,00	1	081490030

8149CM

handkettingen voor kettingblokken 8143



Ø mm	B mm	t mm	€/m		
4,8	8,2	22,2	5,15	1	081490901

* LET OP: Product wordt geleverd in één ketting-lengte, tenzij anders aangegeven in de bestelling!

8149CM/RA

reserve ring voor hand-kettingtakel 8143



L m	Ø mm	B mm	€		
3	4,8	8,2	65,50	1	081490903
6	4,8	8,2	99,00	1	081490906

*Gelaste gesloten ring. Lees de handleiding aandachtig door voordat u de ketting vervangt.



In tegenstelling tot staal voor algemeen gebruik (AISI 304), biedt staal AISI 316, zoals geselecteerd door Beta, een hoge weerstand tegen vertering, zoutcorrosie en zout- en organische zuurcorrosie. Roestvast staal AISI 316 heeft een hoog gehalte aan:

- **Chroom** (vormt een oppervlaktefilm die het onderliggende materiaal tegen oxidatie beschermt);
- **Molybdeen** (het verhoogt de corrosieweerstand van chloriden, bijvoorbeeld zeewater en ontdooiproducten);
- **Nikkel** (hierdoor kan het stalen frame in de tijd stabiel worden gehouden);

Bovendien maakt het lage koolstofgehalte dit staal beter bestand tegen interkristallijne corrosie (een bepaald type corrosie dat nauwelijks kan worden gedetecteerd op het oppervlak van het accessoire en plotselinge breuken kan veroorzaken in corrosieve omgevingen).

Staal AISI 316 kan bogen op enkele extra kenmerken: het is gemakkelijk schoon te maken, heeft een uitstekende hygiënische coëfficiënt, niet-magnetische eigenschappen en goede mechanische prestaties bij lage temperaturen.

Ongetwijfeld was en is uniforme, constante kwaliteit de belangrijkste betrouwbaarheidsfactor van de roestvrijstalen producten van Robur, omdat deze ervoor zorgt dat voor alle productiebatches dezelfde prestatieniveaus worden bereikt – zowel gisteren als vandaag en morgen.

8205

Spanschroeven met twee ogen
Roestvaststaal AISI 316

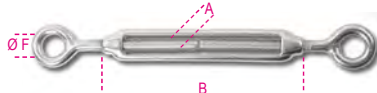

LABORATORIUM TEST

- Chemische analyse
 - Treksterkte test
- VERKRIJGBARE CERTIFICATEN
- Technische product specificaties
 - Test rapport UNI EN10204 type 2.2

A mm	B mm	ØF mm	WFL kg	€	📦	🚚
M4	62	8	75	6,55	10	082050204
M5	72	11	115	7,85	10	082050205
M6	92	12	160	10,40	8	082050206
M8	122	14	300	16,00	8	082050208
M10	150	16	470	24,00	4	082050210
M12	201	18	690	41,00	1	082050212
M14	225	22	940	102,00	1	082050214
M16	244	26	1290	104,00	1	082050216
M20	295	29	2130	150,50	1	082050220
M24	350	33	3000	344,00	1	082050224

speciale pakken



A mm	B mm	📦	€	🚚	🚚
M4	62	5	37,00	1	082050704
M5	72	5	44,00	1	082050705
M6	92	4	47,00	1	082050706
M8	122	4	72,00	1	082050708
M10	150	2	54,00	1	082050710

8206

Spanschroeven met oog en haak
Roestvaststaal AISI 316

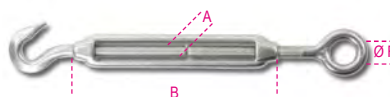

LABORATORIUM TEST

- Chemische analyse
 - Treksterkte test
- VERKRIJGBARE CERTIFICATEN
- Technische product specificaties
 - Test rapport UNI EN10204 type 2.2

A mm	B mm	ØF mm	WFL kg	€	📦	🚚
M5	72	11	25	7,95	10	082060205
M6	92	12	45	11,00	5	082060206
M8	122	14	95	16,70	5	082060208
M10	150	16	140	25,50	1	082060210
M12	201	18	300	43,00	1	082060212
M14	225	22	420	102,50	1	082060214
M16	244	26	570	104,50	1	082060216
M20	295	29	875	153,00	1	082060220

8207

Spanschroeven met haak en haak
Roestvaststaal AISI 316

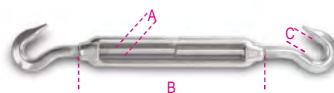

LABORATORIUM TEST

- Chemische analyse
 - Treksterkte test
- VERKRIJGBARE CERTIFICATEN
- Technische product specificaties
 - Test rapport UNI EN10204 type 2.2

A mm	B mm	C mm	WFL kg	€	📦	🚚
M5	72	9	25	8,40	10	082070205
M6	92	9	45	11,10	5	082070206
M8	122	10	95	17,10	5	082070208
M10	150	12	140	26,00	1	082070210
M12	201	14	300	43,50	1	082070212
M14	225	15	420	104,00	1	082070214
M16	244	16	570	108,00	1	082070216
M20	295	19	875	158,50	1	082070220

8209

Spanschroeven met twee gaffels
Roestvaststaal AISI 316

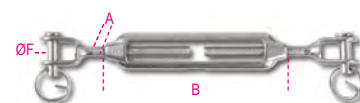

LABORATORIUM TEST

- Chemische analyse
 - Treksterkte test
- VERKRIJGBARE CERTIFICATEN
- Technische product specificaties
 - Test rapport UNI EN10204 type 2.2

A mm	B mm	ØF mm	WFL kg	€	📦	🚚
M5	72	5	115	14,00	5	082090205
M6	92	6	160	16,50	5	082090206
M8	122	8	300	23,70	5	082090208
M10	150	10	470	39,00	1	082090210
M12	201	12	690	62,50	1	082090212
M14	225	14	940	85,00	1	082090214
M16	244	16	1290	127,50	1	082090216
M20	295	20	2130	224,00	1	082090220
M24	350	24	3060	543,00	1	082090224

8210

Spanschroeven met twee gaffels
Roestvaststaal AISI 316

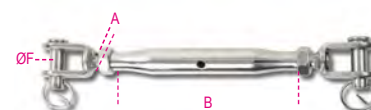

LABORATORIUM TEST

- Chemische analyse
 - Treksterkte test
- VERKRIJGBARE CERTIFICATEN
- Technische product specificaties
 - Test rapport UNI EN10204 type 2.2

A mm	B mm	ØF mm	WFL kg	€	📦	🚚
M5	81	5	115	17,70	3	082100205
M6	92	6	160	21,30	3	082100206
M8	112	8	300	30,50	1	082100208
M10	121	10	470	48,50	1	082100210
M12	150	12	690	80,00	1	082100212
M14	169	14	940	104,00	1	082100214
M16	190	16	1290	154,00	1	082100216
M20	220	20	2130	268,00	1	082100220

8210FTP

schroeven met vaste bek en persfitting
pijp spanschroef body
AISI 316 roestvrij staal"

Staal met nikkel, chroom en molybdeen voor verhoogde
corrosieweerstand.



LABORATORIUM TESTEN

- chemische analyse
 - trekproef
- BESCHIKBARE CERTIFICATEN**
- Technische productspecificaties
 - Testrapport UNI EN10204 type 2.2

Ø mm	A mm	ØD mm	WFL kg	€		
M5	159	2,70	150	19,70	2	082100605
M6	179	3,30	250	23,30	2	082100606
M8	216	4,30	350	32,50	1	082100608
M10	241	5,30	550	49,00	1	082100610
M12	300	6,30	1000	71,00	1	082100612
M14	345	7,30	1350	108,00	1	082100614
M16	383	8,30	1625	156,50	1	082100616
M20	484	10,50	2125	267,00	1	082100620

8201T

Spanschroefhuizen
AISI 316



LABORATORIUM TESTEN

- Chemische analyse
 - Treksterkte test
- VERKRIJGBARE CERTIFICATEN**
- Technische product specificaties
 - Test rapport UNI EN10204 type 2.2

Ø mm	Ø "	WFL kg	L mm	€		
M6	1/4	160	95	3,95	5	082010406
M8	5/16	300	105	5,80	5	082010408
M10	3/8	470	125	9,75	3	082010410
M12	1/2	690	150	17,10	3	082010412
M14	9/16	940	165	18,10	1	082010414
M16	5/8	1290	190	30,50	1	082010416
M20	3/4	2130	210	46,50	1	082010420

8210F

spanschroeven met 2 gaffels
roestvast staal AISI 316"

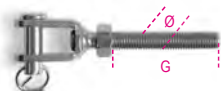

LABORATORIUM TESTS

- chemische analyse
 - trektest
- BESCHIKBARE CERTIFICATEN**
- Technische productspecificaties
 - Testrapport UNI EN10204 type 2.2

Ø mm	≈	G mm	WFL kg	€		
M5	3/16	38,5	115	5,85	4	082100305
M6	1/4	49	160	6,55	4	082100306
M8	5/16	56	300	9,55	4	082100308
M10	3/8	61	470	16,30	2	082100310
M12	1/2	81	690	26,00	2	082100312
M14	9/16	93	940	40,50	2	082100314

gaffels voor voor spanschroeven rechtshandig -galvaniseerd

Ø mm	≈	G mm	WFL kg	€		
M5	3/16	38,5	115	5,85	4	082100405
M6	1/4	49	160	6,55	4	082100406
M8	5/16	56	300	9,55	4	082100408
M10	3/8	61	470	16,30	2	082100410
M12	1/2	81	690	26,00	2	082100412
M14	9/16	93	940	40,50	2	082100414

8248

Oogbouten,
roestvast staal 316L,
rechtste draad



UNI 6058

VERKRIJGBARE CERTIFICATEN

- Technische product specificaties
- Test rapport UNI EN10204 type 2.2

ØxL mm	F mm	€		
8X120	6	7,65	1	082480008
10x80	8	10,30	1	082480010
10x130	8	13,70	1	082480012
12x95	10	15,60	1	082480016
12x125	10	18,50	1	082480018

8249

Oogbouten rechtse draad
Roestvaststaal AISI 316



LABORATORIUM TEST

- Chemische analyse
 - Treksterkte test
- VERKRIJGBARE CERTIFICATEN**
- Technische product specificaties
 - Test rapport UNI EN10204 type 2.2

A mm	WFL kg	D mm	€		
M5	100	50	2,84	10	082490205
M6	160	55	3,60	10	082490206
M8	300	60	5,75	5	082490208
M10	470	80	10,30	5	082490210
M12	690	120	17,90	2	082490212

8249G

Haak met schroefdraad
AISI 316



LABORATORIUM TESTEN

- Chemische analyse
 - Treksterkte test
- VERKRIJGBARE CERTIFICATEN**
- Technische product specificaties
 - Test rapport UNI EN10204 type 2.2

A mm	E mm	ØF mm	WFL kg	€		
M5	39	9	25	1,37	5	082490305
M6	43	10,5	45	1,63	5	082490306
M8	57	14,5	95	2,84	3	082490308

8216

Staaldraad klemmen
Roestvaststaal AISI 316

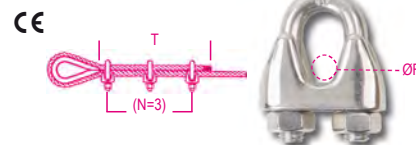

LABORATORIUM TEST

- Chemische analyse
 - Torque test
- VERKRIJGBARE CERTIFICATEN**
- Technische product specificaties
 - Test rapport UNI EN10204 type 2.2
 - CE conformiteits verklaring

Ø F mm	"	T	N	€		
2	5/64	80	3	3,35	20	082160202
3	1/8	80	3	3,40	20	082160203
4	5/32	80	3	3,80	20	082160204
5	3/16	110	3	4,30	20	082160205
6	1/4	120	5	4,80	10	082160206
8	5/16	210	5	6,30	10	082160208
10	3/8	240	5	8,85	8	082160210
12-13	1/2	300	5	12,20	5	082160213
16	5/8	335	5	18,10	5	082160216
20	3/4	540	5	22,80	5	082160220
22	7/8	595	7	37,00	3	082160222

speciale pakken



Ø F mm	"	€		
2	5/64	37,50	1	082160702
3	1/8	38,00	1	082160703
4	5/32	42,50	1	082160704
5	3/16	48,50	1	082160705
6	1/4	27,00	1	082160706
8	5/16	35,50	1	082160708
10	3/8	40,00	1	082160710

Speciale service verpakking



Ø F mm		€		
2	4	13,90	1	082169402
3	4	14,00	1	082169403
4	4	15,80	1	082169404
5	2	9,55	1	082169405
6	2	10,80	1	082169406
8	2	13,90	1	082169408
10	2	18,80	1	082169410



8220

Puntkousen
Roestvaststaal AISI 316

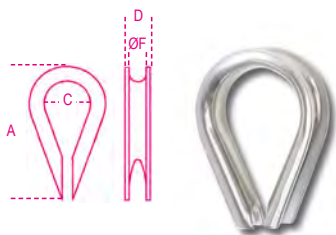

LABORATORIUM TEST

- Chemische analyse
- **VERKRIJGBARE CERTIFICATEN**
- Technische product specificaties
- Test rapport UNI EN10204 type 2.2

ø F mm	D mm	A mm	C mm	€		
2	4,5	21	7,5	1,09	15	082200202
3	6	24	10	1,19	15	082200203
4	6,6	28	11	1,37	10	082200204
5	8,5	30	13	1,63	10	082200205
6	10	37	15	1,85	10	082200206
8	12,5	51	23	2,91	5	082200208
10	14,6	56	27	3,60	5	082200210
12	18	68	32	4,90	5	082200212
14	19	69	34	6,30	5	082200214
16	22	83	37	7,10	5	082200216
18	23	81	38	8,40	1	082200218
20	27,8	105	45	9,90	1	082200220
22	29,6	112	45	12,90	1	082200222

8225

D-sluitingen
Roestvaststaal AISI 316



LABORATORIUM TEST

- Chemische analyse
- **Treksterkte test**
- **VERKRIJGBARE CERTIFICATEN**
- Technische product specificaties
- Test rapport UNI EN10204 type 2.2

ø D mm	A mm	WFL kg	€			
4	5/32	8	50	3,50	20	082250204
5	3/16	11	70	3,85	20	082250205
6	1/4	13	100	4,15	10	082250206
8	5/16	17	250	6,75	10	082250208
10	3/8	21	400	9,75	8	082250210
12	1/2	25	600	16,00	3	082250212
16	5/8	32	1000	35,50	1	082250216
19	3/4	38	1600	58,50	1	082250219
22	7/8	43	2000	91,00	1	082250222
25	1	46	2800	132,50	1	082250225

speciale pakken



ø D mm	A mm	WFL kg	€		
4	5/32	10	39,50	1	082250704
5	3/16	10	43,50	1	082250705
6	1/4	5	23,30	1	082250706
8	5/16	5	38,00	1	082250708
10	3/8	4	44,00	1	082250710

8227

D-sluitingen lang model
Roestvaststaal AISI 316



LABORATORIUM TEST

- Chemische analyse
- **Treksterkte test**
- **VERKRIJGBARE CERTIFICATEN**
- Technische product specificaties
- Test rapport UNI EN10204 type 2.2

ø D mm	A mm	WFL kg	€			
4	5/32	8	50	2,91	10	082270204
5	3/16	10	70	3,40	10	082270205
6	1/4	13,5	100	4,30	5	082270206
8	5/16	17	250	6,95	5	082270208
10	3/8	21	400	11,50	2	082270210
12	1/2	25	600	18,20	1	082270212

8228

Harp-sluitingen
Roestvaststaal AISI 316

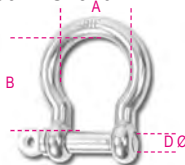

LABORATORIUM TEST

- Chemische analyse
- **Treksterkte test**
- **VERKRIJGBARE CERTIFICATEN**
- Technische product specificaties
- Test rapport UNI EN10204 type 2.2

ø D mm	A mm	B mm	WFL kg	€		
4	13	20	60	2,64	10	082280204
5	17	23	80	3,05	10	082280205
6	20	27	100	3,50	10	082280206
8	28	36	200	5,55	5	082280208
10	36	44	300	8,85	5	082280210
12	41	53	500	14,10	5	082280212
16	54	74	800	30,50	1	082280216
19	66	86	1100	56,50	1	082280219

8240F

Oogbouten, GESMEED, roestvaststaal A4

CE



TECHNISCHE DATA

- Veiligheids factor: 6
- Identificatie code
- **LABORATORIUM TEST**
- Chemische analyse
- Metalgrafische analyse
- **Treksterkte test**
- **VERKRIJGBARE CERTIFICATEN**
- Technische product specificaties
- Test rapport UNI EN10204 type 2.2
- Inspectie certificaat UNI EN10204 type 3.1
- CE conformiteits verklaring

ø mm	WFL mm	WLL kg	€		
M6	1,0	120	7,95	4	082400406
* M8	1,25	200	8,85	4	082400408
* M10	1,5	400	14,90	4	082400410
* M12	1,75	600	24,10	4	082400412
* M14	2	1000	39,00	2	082400414
* M16	2	1200	39,00	2	082400416
* M20	2,5	2000	62,50	2	082400420
* M24	3	2700	118,50	2	082400424
* M30	3,5	4000	262,00	1	082400430

8240

Oogbouten
Roestvaststaal AISI 316



LABORATORIUM TEST

- Chemische analyse
- **Treksterkte test**
- **VERKRIJGBARE CERTIFICATEN**
- Technische product specificaties
- Test rapport UNI EN10204 type 2.2

A mm	B mm	ø C mm	WFL kg	€		
M6	41	15	90	2,28	10	082400206
M8	50	20	140	3,45	10	082400208
M10	62	25	230	6,80	5	082400210
M12	74	30	340	11,50	5	082400212

8242F

Oogmoeren, GESMEED, roestvaststaal A4

CE



TECHNISCHE DATA

• Veiligheids factor: 6

• Identificatie code

LABORATORIUM TEST

• Chemische analyse

• Metalgrafische analyse

• Treksterkte test

VERKRIJGBARE CERTIFICATEN

• Technische product specificaties

• Test rapport UNI EN10204 type 2.2

• Inspectie certificaat UNI EN10204 type 3.1

• CE conformiteits verklaring

ø mm	WLL mm	WLL kg	€		
M6	1,0	120	7,95	4	082420406
* M8	1,25	200	8,85	4	082420408
* M10	1,5	400	14,90	4	082420410
* M12	1,75	600	24,10	4	082420412
* M14	2	1000	39,00	2	082420414
* M16	2	1200	39,00	2	082420416
* M20	2,5	2000	62,50	2	082420420
* M24	3	2700	118,50	2	082420424
* M30	3,5	4000	262,00	1	082420430

8242

Oogmoeren
Roestvaststaal AISI 316



A mm	B mm	øC mm	WFL kg	€		
M6	27	15	90	2,28	10	082420206
M8	36	20	140	3,45	10	082420208
M10	45	25	230	6,80	5	082420210
M12	55	30	340	11,50	5	082420212

8274

Karabijn haken
Roestvaststaal AISI 316

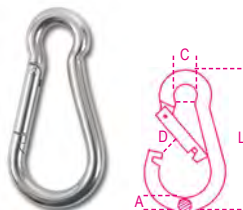

LABORATORIUM TEST

• Chemische analyse

• Treksterkte test

VERKRIJGBARE CERTIFICATEN

• Technische product specificaties

• Test rapport UNI EN10204 type 2.2

ø A x L mm	ø C mm	D mm	WFL kg	€		
4,5x40	6,5	6	20	3,10	20	082740204
5x50	7	6,5	30	3,10	20	082740205
6x60	8,5	7,5	40	3,35	10	082740206
7x70	10	9	60	3,95	10	082740207
8x80	12	10	75	5,25	10	082740208
9x90	12,5	10,5	100	7,20	10	082740209
10x100	15	13	120	9,00	8	082740210
11x120	19	18	140	12,90	1	082740211
12x140	22	21	140	17,60	1	082740212
13x160	22	26	200	22,00	1	082740213

speciale pakken



ø A x L mm	ø C mm	WFL kg	€		
4,5x40	6,5	10	35,00	1	082740704
5x50	7	10	35,00	1	082740705
6x60	8,5	5	18,80	1	082740706
7x70	10	5	22,20	1	082740707
8x80	12	5	29,50	1	082740708
9x90	12,5	5	40,50	1	082740709
10x100	15	4	40,50	1	082740710

8274A

Karabijnhaken AISI 316

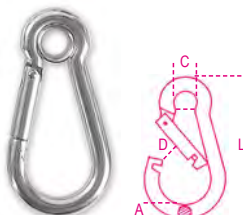

LABORATORIUM TESTEN

• Chemische analyse

• Treksterkte test

VERKRIJGBARE CERTIFICATEN

• Technische product specificaties

• Test rapport UNI EN10204 type 2.2

ø A x L mm	ø C mm	D mm	WFL kg	€		
5x50	6,5	7	30	3,05	10	082740405
6x60	7,5	7,5	40	3,70	5	082740406
8x80	9,5	10	75	6,05	5	082740408

8274G

Karabijn haken met borgring
Roestvaststaal AISI 316

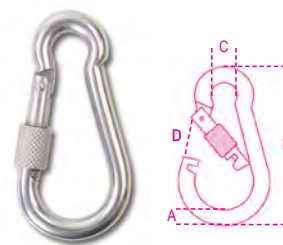

LABORATORIUM TEST

• Chemische analyse

• Treksterkte test

VERKRIJGBARE CERTIFICATEN

• Technische product specificaties

• Test rapport UNI EN10204 type 2.2

ø A x L mm	ø C mm	D mm	WFL kg	€		
6x60	8,5	6,5	40	4,05	5	082740306
8x80	12	8,5	75	7,25	5	082740308
10x100	15	12	120	13,90	3	082740310

8276

Asymmetrische karabijnhaken
Roestvaststaal AISI 316

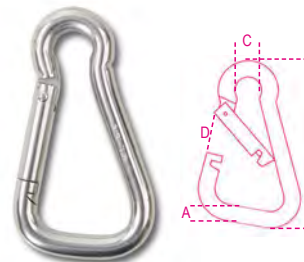

LABORATORIUM TEST

• Chemische analyse

• Treksterkte test

VERKRIJGBARE CERTIFICATEN

• Technische product specificaties

• Test rapport UNI EN10204 type 2.2

ø A x L mm	ø C mm	D mm	WFL kg	€		
6x60	8,5	10	40	3,70	5	082760206
8x80	12	14	75	6,30	5	082760208
10x100	15	18	120	11,20	3	082760210

 Robur

 Robur

82766

Asymmetrisch karabijnhaken met borgring
Roestvaststaal AISI 316

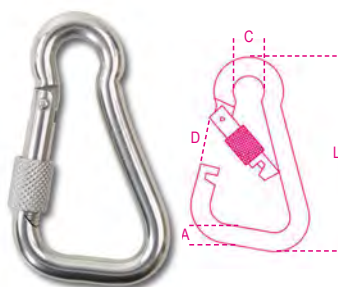

LABORATORIUM TEST

- Chemische analyse
 - Treksterkte test
- VERKRIJGBARE CERTIFICATEN
- Technische product specificaties
 - Test rapport UNI EN10204 type 2.2

ø A x L mm	ø C mm	D mm	WFL kg	€		
6x60	8,5	9	40	4,70	3	082760306
8x80	12	12,5	75	8,40	3	082760308
10x100	15	16	120	15,40	3	082760310

8278

Trapezium vormige karabijnhaken
Roestvaststaal AISI 316

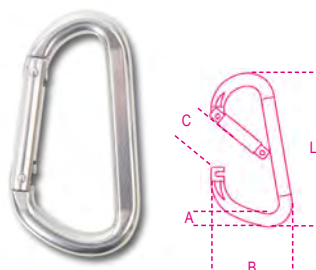

LABORATORIUM TEST

- Chemische analyse
 - Treksterkte test
- VERKRIJGBARE CERTIFICATEN
- Technische product specificaties
 - Test rapport UNI EN10204 type 2.2

ø A x L mm	B mm	C mm	WFL kg	€		
8x80	45	14	75	14,10	3	082780208
10x100	55	16	120	22,00	3	082780210

Robur

8280

Noodschalm met schroefsluiting
Roestvaststaal AISI 316

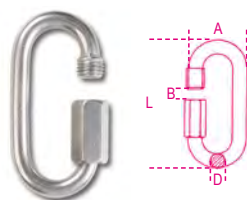

LABORATORIUM TEST

- Chemische analyse
 - Treksterkte test
- VERKRIJGBARE CERTIFICATEN
- Technische product specificaties
 - Test rapport UNI EN10204 type 2.2

ø D x L mm	A mm	B mm	WFL kg	€		
3,5x35	17	5	20	3,65	10	082800203
4x40	19	6	30	3,85	10	082800204
5x50	23	7	50	4,70	5	082800205
6x60	26	8	60	5,55	5	082800206
7x70	30	9	100	6,30	5	082800207
8x80	33	10	140	8,95	2	082800208
10x90	40	12	220	14,50	2	082800210
12x100	47	14	300	22,00	1	082800212

8250

Klepveerhaken
Roestvrijstaal AISI 316



LABORATORIUM TEST

- Chemische analyse
 - Treksterkte test
- VERKRIJGBARE CERTIFICATEN
- Technische product specificaties
 - Test rapport UNI EN10204 type 2.2

L mm	A mm	ø B mm	WFL kg	€		
50	25	8	40	4,55	5	082500205
70	31	12,5	90	6,90	5	082500207
100	47	20	190	11,20	2	082500210

8264

Wartels met musketon haak
Roestvaststaal AISI 316



LABORATORIUM TEST

- Chemische analyse
 - Treksterkte test
- VERKRIJGBARE CERTIFICATEN
- Technische product specificaties
 - Test rapport UNI EN10204 type 2.2

B mm	L mm	C mm	WFL kg	€		
12	88	12	60	12,10	5	082640212
16	90	12	60	12,50	5	082640216
19	93	12	60	12,60	2	082640219

8267

Wartels met klephaak
Roestvaststaal steel AISI 316



LABORATORIUM TEST

- Chemische analyse
 - Treksterkte test
- VERKRIJGBARE CERTIFICATEN
- Technische product specificaties
 - Test rapport UNI EN10204 type 2.2

A mm	L mm	B mm	WFL kg	€		
10	87	21	30	10,80	5	082670210
12	118	22	70	18,00	2	082670213

Robur

Robur

8272

Wartels met dubbel oog
Roestvaststaal AISI 316

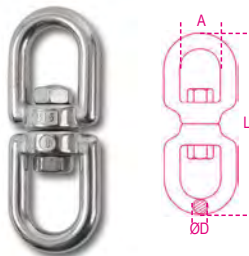

LABORATORIUM TEST

- Chemische analyse
- Treksterkte test

VERKRIJGBARE CERTIFICATEN

- Technische product specificaties
- Test rapport UNI EN10204 type 2.2

Ø D	A	L	WFL	€		
mm	mm	mm	kg			
4	11	50	90	6,05	5	082720204
5	13	60	115	7,95	5	082720205
6	15	66	140	9,80	5	082720206
8	19	90	250	15,80	3	082720208
10	23	112	300	24,20	1	082720210
13	33	148	650	49,00	1	082720213
16	38	184	1000	91,50	1	082720216
19	40	223	1600	163,00	1	082720219

8273

Karabijn haken
met draaibaar oog
AISI 316 roestvast staal



LABORATORIUM TEST

- Chemische analyse
- Treksterkte test

VERKRIJGBARE CERTIFICATEN

- Technische product specificaties
- Test rapport UNI EN10204 type 2.2

Ø C x L	B	WFL	BF	€		
mm x mm	mm	kg	kg			
12x70	12	230	1100	18,50	1	082730012
16x85	14,50	440	2000	26,00	1	082730016
22x120	20	700	3500	40,50	1	082730022

8282S

S-haken, symmetrisch
AISI 316 roestvast staal

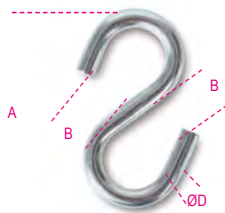

LABORATORIUM TESTS

- Chemische analyse
- Treksterkte test

VERKRIJGBARE CERTIFICATEN

- Product specificaties
- Test rapport type 2.2 UNI EN10204

Ø D	B	A	WFL	€		
mm	mm	mm	kg			
3	5,5	34	4	0,33	40	082820303
4	7,0	40	5	0,67	30	082820304
5	9,0	46	12	1,09	20	082820305
6	10	54	18	1,79	15	082820306

8284

Pelikaan haken
AISI 316 roestvast staal



LABORATORIUM TEST

- Chemische analyse
- Treksterkte test

VERKRIJGBARE CERTIFICATEN

- Technische product specificaties
- Test rapport UNI EN10204 type 2.2

Ø C	B	L	WFL	€		
mm	mm	mm	kg			
6	11	73	200	17,90	3	082840006
8	14	98	300	24,10	3	082840008
10	23	143	450	50,00	1	082840010

8285

Gaffel terminals
Roestvaststaal AISI 316

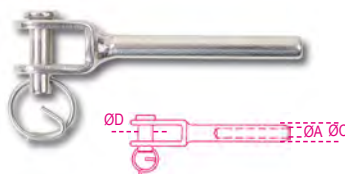

LABORATORIUM TEST

- Chemische analyse
- Treksterkte test

VERKRIJGBARE CERTIFICATEN

- Technische product specificaties
- Test rapport UNI EN10204 type 2.2

Ø A	Ø C	Ø D	WFL	€		
M	mm	mm	kg			
3	6,3	6	180	3,60	5	082850203
4	7,5	8	200	5,75	3	082850204
5	9	10	330	7,85	2	082850205
6	12,5	12	720	16,30	2	082850206
7	12,5	12	850	17,50	2	082850207
8	15,5	16	1120	23,40	2	082850208
10	18	16	1300	33,50	2	082850210
12	20	19	2400	39,50	2	082850212

8286

Oog terminals
Roestvaststaal AISI 316



LABORATORIUM TEST

- Chemische analyse
- Treksterkte test

VERKRIJGBARE CERTIFICATEN

- Technische product specificaties
- Test rapport UNI EN10204 type 2.2

Ø D	Ø A	Ø C	WFL	€		
M	mm	mm	kg			
3	6,5	6,3	180	3,70	5	082860203
4	8,5	7,5	200	4,30	3	082860204
5	10	9	330	5,75	2	082860205
6	12,5	12,6	720	9,40	2	082860206
7	12,5	14,2	850	10,20	2	082860207
8	14,5	16	1120	17,10	2	082860208
10	16,4	18	1300	29,50	2	082860210
12	19,3	20	2400	43,00	2	082860212

8287

Schroefdraad terminals
Roestvaststaal steel AISI 316

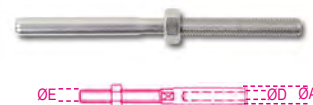

LABORATORIUM TEST

- Chemische analyse
- Treksterkte test

VERKRIJGBARE CERTIFICATEN

- Technische product specificaties
- Test rapport UNI EN10204 type 2.2

Ø D	Ø A	E	WFL	€		
M	mm	mm	kg			
3	6,2	M6	180	3,25	5	082870203
4	7,5	M8	200	4,55	3	082870204
5	8,7	M10	330	6,30	2	082870205
6	12,6	M12	720	11,60	2	082870206
7	12,6	M14	850	16,20	2	082870207
8	16	M16	1120	23,40	2	082870208
10	18	M16	1300	26,00	2	082870210
12	20	M20	2400	36,00	2	082870212

8290

Beugels
Roestvaststaal AISI 316



LABORATORIUM TEST

- Chemische analyse
- Treksterkte test

VERKRIJGBARE CERTIFICATEN

- Technische product specificaties
- Test rapport UNI EN10204 type 2.2

Ø A	B	Ø C	L	€		
mm	mm	mm	mm			
5	18	4,3	40	1,16	5	082900205
6	22	5,2	44	1,63	5	082900206
8	23	5,2	51	2,57	5	082900208



8381SX

U-bouten voor buizen

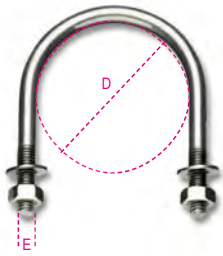

AISI 304

LABORATORIUM TEST

- chemische analyse
- VERKRIJGBARE CERTIFICATEN
- Test rapport UNI EN10204 type 2.2

D mm	D gas	E mm	€		
11	1/8"	M6	2,84	20	083810401
14	1/4"	M6	2,91	20	083810402
18	3/8"	M6	2,99	20	083810403
22	1/2"	M6	3,05	20	083810404
27	3/4"	M6	3,10	20	083810405
34	1"	M6	3,35	20	083810406
43	1 1/4"	M6	3,80	20	083810407
49	1 1/2"	M8	6,75	10	083810408
61	2"	M8	7,45	10	083810409
77	2 1/2"	M8	8,60	10	083810410
89	3"	M8	9,55	10	083810412
115	4"	M8	12,20	10	083810413
168	6"	M10	23,40	1	083810416
220	8"	M10	28,00	1	083810418

8279

Genovese ketting voor statische verbinding, AISI 304 roestvast staal



TECHNISCHE DATA

- Veiligheids factor: 4
- VERKRIJGBARE CERTIFICATEN
- Technische product specificaties
- Test rapport UNI EN10204 type 2.2

Ø mm	nr	WFL kg	m	€		
2	13	20	50	277,00	1	082790020
3	17	55	50	503,00	1	082790030
4	19	100	50	709,00	1	082790040
5	21	250	40	779,00	1	082790050
6	23	310	30	792,00	1	082790060
8	27	400	15	779,00	1	082790080
10	30	1000	10	1.220,00	1	082790400

Opgelet: product is NIET ontworpen voor heffen

Robur

8293

Ratelsjorband met haak AISI 304
Hoog treksterkte polyester band, LC 300 kg, met haken

Ophangbaar

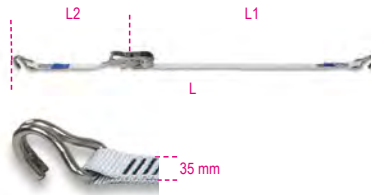

L m	L2 mm	L1 mm	STF daN	€		
6	5700	300	100	79,00	1	082930106

LC = 300 kg

8297C

Ratelspanband met mini ratels, AISI 304, hoog-treksterkte polyester band, LC 700 kg

Ophangbaar

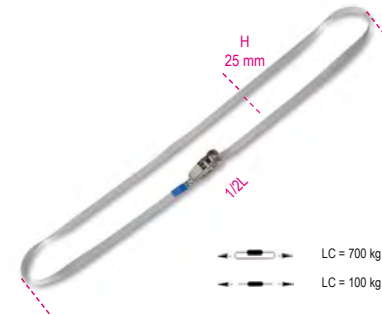

L m	H mm	€		
5	25	35,00	1	082970350

8297F

Ratelspanband met 2 gespen, AISI 304, hoog-treksterkte polyester band, LC 250 kg

Ophangbaar

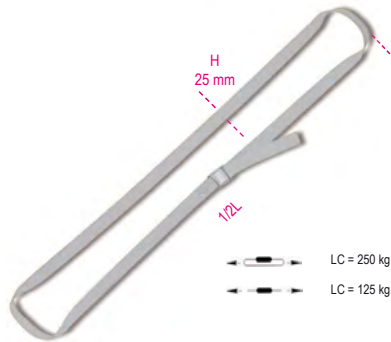

L m	H mm	€		
3	25	35,00	1	082970230

LC = 250 kg

TECHNISCHE DATA

- Veiligheids factor: 7

- Identificatie code

LABORATORIUM TEST

- Treksterkte test

VERKRIJGBARE CERTIFICATEN

- Technische product specificaties
- Test rapport UNI EN10204 type 2.2
- Fabrieks Certificaat UNI EN1492
- CE conformiteits verklaring

			$\beta = 0^\circ + 45^\circ$	$\beta = 45^\circ + 60^\circ$
1t	0,8t	2t	1,4t	1t
2t	1,6t	4t	2,8t	2t
3t	2,4t	6t	4,2t	3t
4t	3,2t	8t	5,6t	4t
5t	4t	10t	7t	5t
6t	4,8t	12t	8,4t	6t
8t	6,4t	16t	11,2t	8t
10t	8t	20t	14t	10t
12t	9,6t	24t	16,8t	12t
15t	12t	30t	21t	15t
20t	16t	40t	28t	20t
25t	20t	50t	35t	25t
30t	24t	60t	42t	30t
40t	32t	80t	56t	40t
50t	40t	100t	70t	50t

8150

Hijsbanden, paars 1 ton, twee laags met versterkte ogen. Groot trekbelastbaar polyester (PES) band.

CE



EN 1492-1

L m	H mm	WLL ton	€		
0,5	30	1	5,85	1	081500005
1	30	1	7,35	1	081500010
1,5	30	1	9,55	1	081500015
2	30	1	10,50	1	081500020
2,5	30	1	12,00	1	081500025
3	30	1	13,40	1	081500030
3,5	30	1	14,90	1	081500035
4	30	1	17,30	1	081500040
5	30	1	20,20	1	081500050
6	30	1	23,10	1	081500060
8	30	1	30,00	1	081500080

8153

Hijsbanden, groen 2 ton, twee laags met versterkte ogen. Groot trekbelastbaar polyester (PES) band.

CE

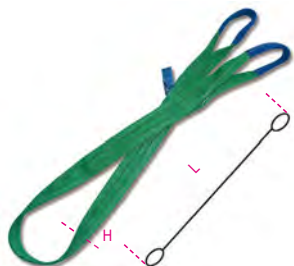

EN 1492-1

L m	H mm	WLL ton	€	📄	📦
1	60	2	11,70	1	081530010
1,5	60	2	15,80	1	081530015
2	60	2	18,10	1	081530020
2,5	60	2	21,30	1	081530025
3	60	2	24,50	1	081530030
3,5	60	2	28,50	1	081530035
4	60	2	30,00	1	081530040
5	60	2	37,50	1	081530050
6	60	2	44,00	1	081530060
8	60	2	56,00	1	081530080
10	60	2	67,50	1	081530100

8156

Hijsbanden, geel 3 ton, twee laags met versterkte ogen. Groot trekbelastbaar polyester (PES) band.

CE

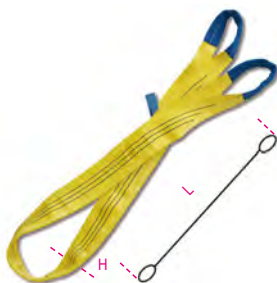

EN 1492-1

L m	H mm	WLL ton	€	📄	📦
1	90	3	16,60	1	081560010
1,5	90	3	21,90	1	081560015
2	90	3	27,00	1	081560020
2,5	90	3	32,50	1	081560025
3	90	3	38,00	1	081560030
3,5	90	3	42,00	1	081560035
4	90	3	46,50	1	081560040
5	90	3	56,50	1	081560050
6	90	3	65,50	1	081560060
8	90	3	86,00	1	081560080
10	90	3	104,50	1	081560100
12	90	3	131,00	1	081560120

8157

Hijsbanden, grijs 4 ton, twee laags met versterkte ogen. Groot trekbelastbaar polyester (PES) band.

CE



EN 1492-1

L m	H mm	WLL ton	€	📄	📦
2	120	4	37,50	1	081570020
3	120	4	49,50	1	081570030
4	120	4	64,00	1	081570040
5	120	4	77,00	1	081570050
6	120	4	89,50	1	081570060
8	120	4	116,50	1	081570080
10	120	4	142,50	1	081570100
12	120	4	179,50	1	081570120

8158

Hijsbanden, rood 5 ton, twee laags met versterkte ogen. Groot trekbelastbaar polyester (PES) band.

CE



EN 1492-1

L m	H mm	WLL ton	€	📄	📦
2	150	5	51,00	1	081580020
3	150	5	67,50	1	081580030
4	150	5	86,50	1	081580040
5	150	5	103,00	1	081580050
6	150	5	122,00	1	081580060
8	150	5	157,00	1	081580080
10	150	5	193,50	1	081580100
12	150	5	243,00	1	081580120

8159

Hijsbanden, bruin 6 ton, twee laags met versterkte ogen. Groot trekbelastbaar polyester (PES) band.

CE



EN 1492-1

L m	H mm	WLL ton	€	📄	📦
2	180	6	64,00	1	081590020
3	180	6	94,00	1	081590030
4	180	6	120,00	1	081590040
5	180	6	145,00	1	081590050
6	180	6	169,50	1	081590060
8	180	6	221,50	1	081590080
10	180	6	275,00	1	081590100

8160

Hijsbanden, blauw 8 ton, twee laags met versterkte ogen. Groot trekbelastbaar polyester (PES) band.

CE



EN 1492-1

L m	H mm	WLL ton	€	📄	📦
3	240	8	129,00	1	081600030
4	240	8	164,00	1	081600040
5	240	8	195,00	1	081600050
6	240	8	231,00	1	081600060
8	240	8	298,00	1	081600080
10	240	8	370,00	1	081600100

8161

hijsbanden, oranje,
10t tweelaagse platte slinger,
20t vierlaagse platte slinger,
versterkte ogen

CE



EN 1492-1

L m	H mm	WLL ton	€	U	L
3	300	10	177,00	1	081610030
4	300	10	261,00	1	081610040
5	300	10	313,00	1	081610050
6	300	10	364,00	1	081610060
8	300	10	481,00	1	081610080
10	300	10	586,00	1	081610100
12	300	10	704,00	1	081610120
3	300	20	540,00	1	081612030
4	300	20	675,00	1	081612040
5	300	20	815,00	1	081612050
6	300	20	955,00	1	081612060
8	300	20	1.225,00	1	081612080
10	300	20	1.500,00	1	081612100
12	300	20	1.785,00	1	081612120

8170

Ronde stropen, paars 1 ton. Groot
trekbelastbaar polyester (PES) band

CE



EN 1492-2

L m	WLL ton	H mm	€	U	L
0,5	1	45	6,30	1	081700010
1	1	45	8,30	1	081700020
1,5	1	45	11,70	1	081700030
2	1	45	15,30	1	081700040
2,5	1	45	18,80	1	081700050
3	1	45	22,10	1	081700060
4	1	45	29,00	1	081700080
5	1	45	37,00	1	081700100

8173

Ronde stropen, groen 2 ton. Groot
trekbelastbaar polyester (PES) band

CE

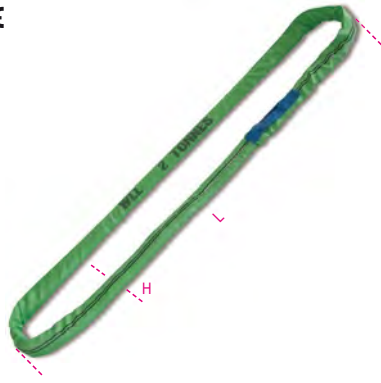

EN 1492-2

L m	H mm	WLL ton	€	U	L
0,5	50	2	8,30	1	081730010
1	50	2	12,60	1	081730020
1,5	50	2	18,40	1	081730030
2	50	2	24,10	1	081730040
2,5	50	2	29,50	1	081730050
3	50	2	35,50	1	081730060
4	50	2	47,50	1	081730080
5	50	2	59,00	1	081730100
6	50	2	71,00	1	081730120
8	50	2	93,00	1	081730160

8176

Ronde stropen, geel 3 ton. Groot
trekbelastbaar polyester (PES) band

CE



EN 1492-2

L m	H mm	WLL ton	€	U	L
0,5	60	3	9,15	1	081760010
1	60	3	16,70	1	081760020
1,5	60	3	24,10	1	081760030
2	60	3	31,50	1	081760040
2,5	60	3	39,00	1	081760050
3	60	3	47,00	1	081760060
4	60	3	62,00	1	081760080
5	60	3	78,00	1	081760100
6	60	3	94,00	1	081760120
8	60	3	123,50	1	081760160

8177

Ronde stropen, grijs 4 ton. Groot
trekbelastbaar polyester (PES) band

CE



EN 1492-2

L m	H mm	WLL ton	€	U	L
0,5	65	4	18,30	1	081770010
1	65	4	19,80	1	081770020
1,5	65	4	29,00	1	081770030
2	65	4	38,50	1	081770040
2,5	65	4	48,00	1	081770050
3	65	4	57,50	1	081770060
4	65	4	75,00	1	081770080
5	65	4	94,00	1	081770100
6	65	4	112,00	1	081770120
8	65	4	150,00	1	081770160

8178

Ronde stropen, rood 5 ton. Groot
trekbelastbaar polyester (PES) band

CE

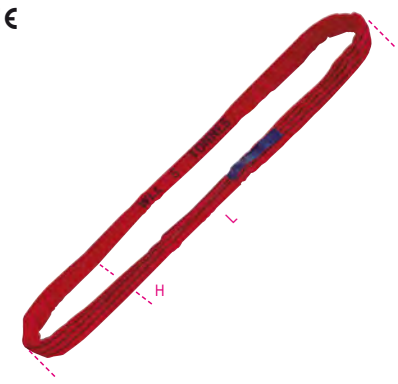

EN 1492-2

L m	H mm	WLL ton	€	U	L
0,5	70	5	28,50	1	081780010
1	70	5	24,50	1	081780020
1,5	70	5	37,00	1	081780030
2	70	5	48,00	1	081780040
2,5	70	5	58,50	1	081780050
3	70	5	69,50	1	081780060
4	70	5	93,00	1	081780080
5	70	5	116,50	1	081780100
6	70	5	139,00	1	081780120
8	70	5	185,00	1	081780160

8179M

Ronde stropen, bruin 6 ton. Groot trekbelastbaar polyester (PES) band

CE

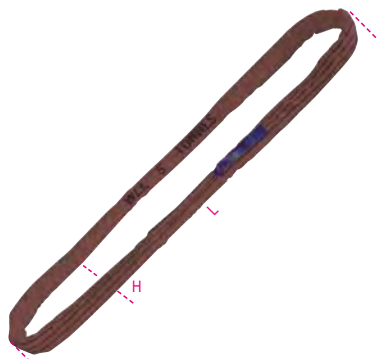

EN 1492-2

L m	H mm	WLL ton	€		
1	80	6	30,50	1	081790020
1,5	80	6	45,50	1	081790030
2	80	6	59,50	1	081790040
2,5	80	6	73,00	1	081790050
3	80	6	86,00	1	081790060
4	80	6	114,50	1	081790080
5	80	6	144,50	1	081790100
6	80	6	171,00	1	081790120
8	80	6	228,00	1	081790160

8179B

Ronde stropen, blauw 8 t, Groot trekbelastbaar polyester (PES) band

CE

EN 1492-2

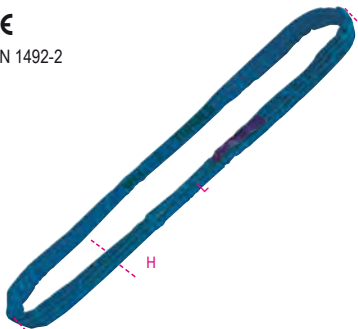

L m	H mm	WLL ton	€		
1	85	8	39,50	1	081790220
1,5	85	8	59,50	1	081790230
2	85	8	79,00	1	081790240
2,5	85	8	98,00	1	081790250
3	85	8	113,50	1	081790260
4	85	8	151,50	1	081790280
5	85	8	195,00	1	081790300
6	85	8	227,00	1	081790320
8	85	8	303,00	1	081790360

8179A

Ronde stropen, oranje, 10t+50t, Groot trekbelastbaar polyester (PES) band

CE

EN 1492-2

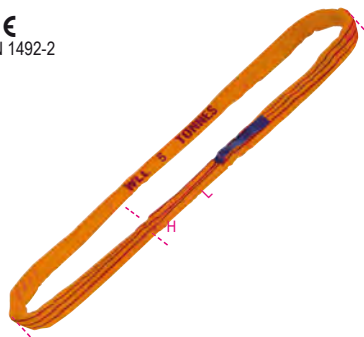

L m	H mm	WLL ton	€		
1	95	10	59,00	1	081790502
1,5	95	10	81,50	1	081790503
2	95	10	115,50	1	081790504
2,5	95	10	134,50	1	081790505
3	95	10	178,00	1	081790506
4	95	10	232,00	1	081790508
5	95	10	260,00	1	081790510
6	95	10	345,00	1	081790512
8	95	10	423,00	1	081790516
10	95	10	578,00	1	081790520
12	95	10	388,00	1	081790524
2	100	12	179,50	1	081791204
2,5	100	12	212,50	1	081791205
3	100	12	245,00	1	081791206
3,5	100	12	278,00	1	081791207
4	100	12	310,00	1	081791208
4,5	100	12	313,00	1	081791209
5	100	12	375,00	1	081791210
5,5	100	12	408,00	1	081791211
6	100	12	439,00	1	081791212
6,5	100	12	472,00	1	081791213
7	100	12	506,00	1	081791214
7,5	100	12	537,00	1	081791215
8	100	12	569,00	1	081791216
8,5	100	12	603,00	1	081791217
9	100	12	636,00	1	081791218
9,5	100	12	667,00	1	081791219
10	100	12	700,00	1	081791220
2	110	15	222,50	1	081791504
2,5	110	15	260,00	1	081791505
3	110	15	297,00	1	081791506
3,5	110	15	335,00	1	081791507
4	110	15	373,00	1	081791508
4,5	110	15	409,00	1	081791509
5	110	15	446,00	1	081791510
5,5	110	15	486,00	1	081791511
6	110	15	521,00	1	081791512
6,5	110	15	559,00	1	081791513
7	110	15	597,00	1	081791514
7,5	110	15	633,00	1	081791515
8	110	15	671,00	1	081791516
8,5	110	15	709,00	1	081791517
9	110	15	746,00	1	081791518
9,5	110	15	792,00	1	081791519
10	110	15	821,00	1	081791520
2	130	20	262,00	1	081792004
2,5	130	20	307,00	1	081792005
3	130	20	352,00	1	081792006
3,5	130	20	397,00	1	081792007
4	130	20	444,00	1	081792008
4,5	130	20	489,00	1	081792009
5	130	20	534,00	1	081792010
5,5	130	20	579,00	1	081792011
6	130	20	625,00	1	081792012
6,5	130	20	669,00	1	081792013
7	130	20	714,00	1	081792014
7,5	130	20	760,00	1	081792015
8	130	20	806,00	1	081792016
8,5	130	20	852,00	1	081792017
9	130	20	896,00	1	081792018
9,5	130	20	942,00	1	081792019
10	130	20	987,00	1	081792020

2	135	25	290,00	1	081792504
2,5	135	25	346,00	1	081792505
3	135	25	404,00	1	081792506
3,5	135	25	458,00	1	081792507
4	135	25	517,00	1	081792508
4,5	135	25	573,00	1	081792509
5	135	25	630,00	1	081792510
5,5	135	25	686,00	1	081792511
6	135	25	744,00	1	081792512
6,5	135	25	802,00	1	081792513
7	135	25	858,00	1	081792514
7,5	135	25	914,00	1	081792515
8	135	25	971,00	1	081792516
8,5	135	25	1.028,00	1	081792517
9	135	25	1.085,00	1	081792518
9,5	135	25	1.142,00	1	081792519
10	135	25	1.197,00	1	081792520
2	160	30	340,00	1	081793004
2,5	160	30	409,00	1	081793005
3	160	30	479,00	1	081793006
3,5	160	30	548,00	1	081793007
4	160	30	618,00	1	081793008
4,5	160	30	686,00	1	081793009
5	160	30	755,00	1	081793010
5,5	160	30	825,00	1	081793011
6	160	30	894,00	1	081793012
6,5	160	30	963,00	1	081793013
7	160	30	1.032,00	1	081793014
7,5	160	30	1.101,00	1	081793015
8	160	30	1.170,00	1	081793016
8,5	160	30	1.240,00	1	081793017
9	160	30	1.305,00	1	081793018
9,5	160	30	1.385,00	1	081793019
10	160	30	1.450,00	1	081793020
2	165	40	472,00	1	081794004
2,5	165	40	528,00	1	081794005
3	165	40	614,00	1	081794006
3,5	165	40	701,00	1	081794007
4	165	40	787,00	1	081794008
4,5	165	40	873,00	1	081794009
5	165	40	960,00	1	081794010
5,5	165	40	1.047,00	1	081794011
6	165	40	1.133,00	1	081794012
6,5	165	40	1.220,00	1	081794013
7	165	40	1.305,00	1	081794014
7,5	165	40	1.400,00	1	081794015
8	165	40	1.480,00	1	081794016
8,5	165	40	1.570,00	1	081794017
9	165	40	1.655,00	1	081794018
9,5	165	40	1.740,00	1	081794019
10	165	40	1.825,00	1	081794020
3	180	50	711,00	1	081795006
3,5	180	50	812,00	1	081795007
4	180	50	912,00	1	081795008
4,5	180	50	1.010,00	1	081795009
5	180	50	1.107,00	1	081795010
5,5	180	50	1.210,00	1	081795011
6	180	50	1.305,00	1	081795012
6,5	180	50	1.410,00	1	081795013
7	180	50	1.505,00	1	081795014
7,5	180	50	1.605,00	1	081795015
8	180	50	1.700,00	1	081795016
8,5	180	50	1.795,00	1	081795017
9	180	50	1.885,00	1	081795018
9,5	180	50	1.995,00	1	081795019
10	180	50	2.090,00	1	081795020

 Robur

 Robur

8166

Beschermhulzen voor hijsbanden, hoog en duurzaam polyester (PES), met een onderlaag uit elastomeer materiaal



H mm	ø mm	L m	€	1	081660073
70	45	3	25,50	1	081660073
80	52	3	29,50	1	081660083
110	70	3	36,50	1	081660103
155	100	3	76,00	1	081660153
170	110	3	83,50	1	081660170
235	150	4	228,50	1	081660235

H mm	Ø mm	L m	€	1	081660073
70	8150	8170-8173	081660073		
80	8153	8176	081660083		
110	8153-8156	8177-8178	081660103		
155	8157	8178-8179A 8179B-8179M	081660153		
170	8158	-	081660170		
235	8159	-	081660235		

8090F

Verbindingsschalm voor polyester hijsbanden, staallegering, gelakt

CE

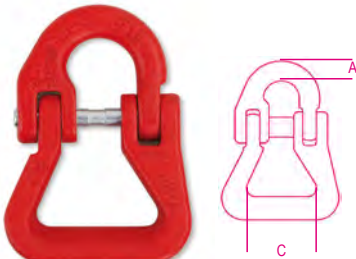

EN 1677-1

TECHNISCHE DATA

- Veiligheids factor: 4
- Hittebehandeling: gehard en getemperd
- Identificatie code

LABORATORIUM TEST

- chemische analyse, metalgrafische analyse
- Limietbelasting test (WLL x 2.5)
- Treksterkte test
- Vermoeidheid test (min. 20,000 cycles)

VERKRIJGBARE CERTIFICATEN

- Technische product specificaties
- Test rapport UNI EN10204 type 2.2
- Inspectie certificaat UNI EN10204 type 3.1
- CE conformiteits verklaring

WLL kg	Ø mm	A mm	C mm	€	1	080900220
2000	7-8	10,5	40	31,50	1	080900220
3150	10	12	50	39,50	1	080900232
5300	13	17	60	60,00	1	080900253
8000	16	21	75	92,00	1	080900280

RATEL SJORBAND

coefficient 2:1

Conform de norm UNI EN 12195

TECHNISCHE DATA

- Veiligheids factor: 2
- Identificatie code

LABORATORIUM TEST

- Voorspanning rateltest

- Vervorming van metalen delen test

- Complete configuratie treksterkte test

VERKRIJGBARE CERTIFICATEN

- Technische product specificaties
- Test rapport UNI EN10204 type 2.2

8180

Ratel-sjorband met haak

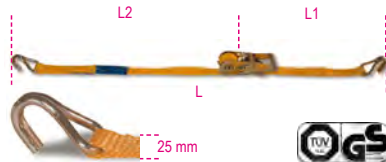

EN 12195-2

L m	L2 mm	L1 mm	STF daN	€	1	081800004
4	3750	250	200	15,40	1	081800004
6	5750	250	200	17,70	1	081800006
8	7750	250	200	19,90	1	081800008

LC = 750 kg

8181

Ratel-sjorband met haak



EN 12195-2

L m	L2 mm	L1 mm	STF daN	€	1	081810004
4	3600	400	180	18,70	1	081810004
6	5600	400	180	21,50	1	081810006
8	7600	400	180	23,50	1	081810008

LC = 1000 kg

81816/S4

set van 4 spanbanden, LC 1000 kg, met waterdichte polyester rugzak



EN 12195-2

L mm	L1 mm	L2 mm	STF daN	€	1	081810906
6	400	5600	180	95,00	1	081810906

8181S

Ratel sjorband met dubbele haak, LC 1000kg, Hoge treksterkte polyester (PES) band

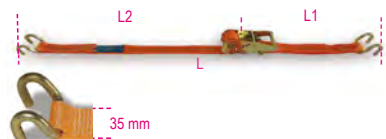

EN 12195-2

L m	L2 mm	L1 mm	STF daN	€	1	081810206
6	5600	400	180	20,80	1	081810206

LC = 1000 kg

8182E

Ratelspanbanden voor in de laadruimte van vracht en bedrijfsvoertuigen, LC 1000 kg, hoog trekbelastbaar polyester (PES) band



EN 12195-2

L m	L2 mm	L1 mm	STF daN	€	1	081820440
4	3500	500	220	21,50	1	081820440

LC = 1000 kg

	L2 mm	L1 mm	€	1	081820942
8182EL 2500	2500		6,60	1	081820942
8182EC 1500	1500		14,20	1	081820945

8182T

Ratelspanband met dubbele haak, LC 1500kg, hoge treksterkte polyester (PES) band

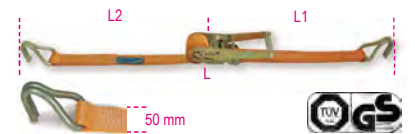

EN 12195-2

L m	L2 mm	L1 mm	STF daN	€	1	081821085
8,5	8100	400	300	33,50	1	081821085
10,5	10100	400	300	36,50	1	081821105

LC = 1500 kg

8182TS

Ratelspanband met enkele haak, LC 1500kg, hoge treksterkte polyester (PES) band

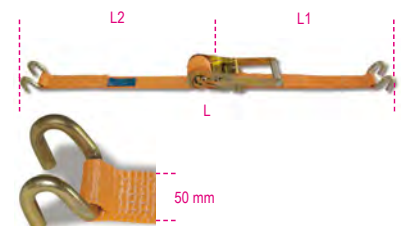

EN 12195-2

L m	L2 mm	L1 mm	STF daN	€	1	081821285
8,5	8100	400	300	34,50	1	081821285
10,5	10100	400	300	38,50	1	081821305

LC = 1500 kg

8182

Ratel-sjorband met haak

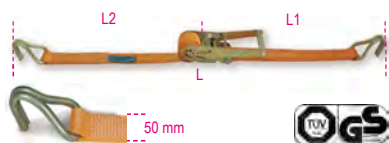

EN 12195-2

L m	L2 mm	L1 mm	STF daN	€	🚚	📄
4,5	4100	400	300	29,50	1	081820045
6,5	6100	400	300	35,50	1	081820065
8,5	8100	400	300	38,00	1	081820085
10,5	10100	400	300	43,50	1	081820105
14,5	14100	400	300	49,00	1	081820145
16,5	16100	400	300	56,00	1	081820165

LC = 2000 kg

	L2 mm	L1 mm	€	🚚	📄
8182LP 8100	8100		20,80	1	081820902
8182SP 400		400	21,50	1	081820905

8182 8,5/S2

set van 2 spanbanden, LC 2000 kg, met waterdichte polyester rugzak

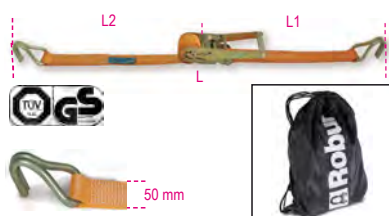

EN 12195-2

L mm	L1 mm	L2 mm	STF daN	€	🚚	📄
8,5	400	8100	300	85,00	1	081821985

8182S

Ratel-sjorband met dubbele haak

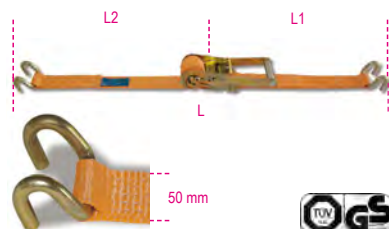

EN 12195-2

L m	L1 mm	L2 mm	STF daN	€	🚚	📄
6,5	400	6100	300	34,50	1	081820265
8,5	400	8100	300	39,50	1	081820285
10,5	400	10100	300	43,50	1	081820305

LC = 2000 kg

	L2 mm	L1 mm	€	🚚	📄
8182SLP 8100	8100	-	20,30	1	081820912
8182SSP 400		400	20,80	1	081820915

8182GD

ratel spanband met delthaak, LC 2000 kg, polyester riem met hoge sterktegraad (PES)



EN 12195-2

L m	L2 mm	L1 mm	STF daN	€	🚚	📄
8,5	8100	400	300	45,50	1	081820485

LC = 2000 kg

8182A

Ratelspanbanden met twee ogen, Hoge treksterkte polyester (PES) band, LC 2000 kg



EN 12195-2

L m	L2 mm	L1 mm	STF daN	€	🚚	📄
8,5	8100	400	300	39,50	1	081820585

LC = 2000 kg

8182H

Ratelspanband met enkele haak, LC 2500kg, hoge treksterkte polyester (PES) band

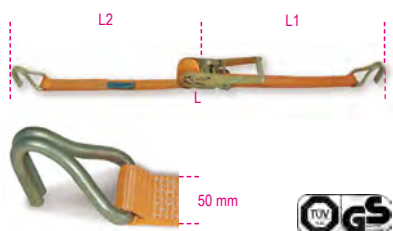

EN 12195-2

L m	L2 mm	L1 mm	STF daN	€	🚚	📄
6,5	6100	400	300	38,50	1	081820406
8,5	8100	400	300	41,50	1	081820408
10,5	10100	400	300	46,00	1	081820410
14,5	14100	400	300	58,00	1	081820414

LC = 2500 kg

8182H/2

Ratel spanband met dubbele haak, LC 2500 kg, polyester riem met hoge sterktegraad (PES)

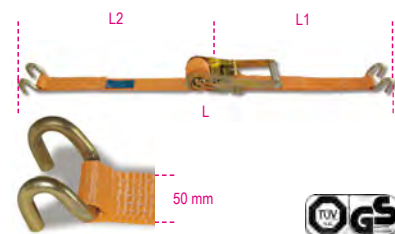

EN 12195-2

L m	L1 mm	L2 mm	STF daN	€	🚚	📄
8,5	8100	400	300	44,50	1	081820385

LC = 2500 kg

8184

Ratelsjorband, lange spangreep, met enkel haak, LC 2500 kg, Duurzaam polyester (PES) band



EN12195-2

L m	L2 mm	L1 mm	STF daN	€	🚚	📄
6,5	6100	400	500	43,00	1	081840065
8,5	8100	400	500	45,00	1	081840085
10,5	10100	400	500	48,00	1	081840105

LC = 2500 kg

8183

Ratelspanband met enkele haak, LC 5000 kg, hoge treksterkte polyester (PES) band



EN 12195-2

L m	L2 mm	L1 mm	STF daN	€	🚚	📄
8,5	8000	500	500	120,50	1	081830085
12,5	12000	500	500	144,00	1	081830125

LC = 5000 kg



8190

Kettingspanner met 2 haken
Grade 8



EN12195/3

TECHNISCHE DATA

- Veiligheids factor: 2
- Hittebehandeling: gehard en getemperd
- Identificatie code

VERKRIJGBARE CERTIFICATEN

- Technische product specificaties
- Test rapport UNI EN10204 type 2.2
- Inspectie certificaat UNI EN10204 type 3.1

Ø mm	LC daN	Ø mm	LC daN	€		
10	6300	8	4000	88,50	1	081900010
13	10000	-	-	135,00	1	081900013

* LET OP: het product kan worden gebruikt met een ketting van 8 mm, op voorwaarde dat de WLL wordt verlaagd (LC 4000 daN)

8190B

Kettingleng



EN12195/3

TECHNISCHE DATA

- Veiligheids factor: 2
- Hittebehandeling: gehard en getemperd
- Ketting leng identificate label

MEEGELEVERDE CERTIFICATEN

- Fabricage Certificaat
- Technische product specificaties

Ø mm	LC daN	L m	L1 m	€		
8	4000	3,5	3,30	192,50	1	081901308
10	6300	3,5	3,28	292,00	1	081901310
13	10000	3,5	3,23	426,00	1	081901313

Robur

8185

Ratel-sjorband met oog



EN 12195-2

L m	STF daN	€		
5	200	12,60	1	081850005
8	200	15,40	1	081850008

8186

Ratel-sjorband met oog



EN 12195-2

L m	STF daN	€		
5	180	15,40	1	081860005
8	180	19,50	1	081860008

8187

Ratel-sjorband met oog



EN 12195-2

L m	STF daN	€		
5	350	28,00	1	081870005
8	350	33,50	1	081870008

8188C

Ratel spanbanden met gesp.LC 750 kg.
Duurzaam polypropyleen (PP) band



EN 12195-2

L m	STF daN	€		
1,5	72	5,05	3	081880315
2,5	72	6,00	3	081880325
5	72	7,55	3	081880350

8188CG/25

Ratel spanbanden met 2 haken,
LC 400 kg
Hoge treksterkte polyester (PES) band



EN 12195-2

L m	L1 mm	L2 mm	STF daN	€		
3	480	170	120	11,30	1	081880430
5	480	170	120	12,10	1	081880450

Robur

8188CU/25

Spanbanden met enkele haken,
LC 400 kg,
Hoge treksterkte polyester band (PES)



EN 12195-2

L	L1	L2	€	U	U
5	300	4700	11,60	1	081880750

8188F

Spanbanden met gesp LC 200 kg. Duurzaam
polypropyleen (PP) band

- 1,5 m
- 2,0 m
- 2,5 m
- 3,0 m
- 5,0 m

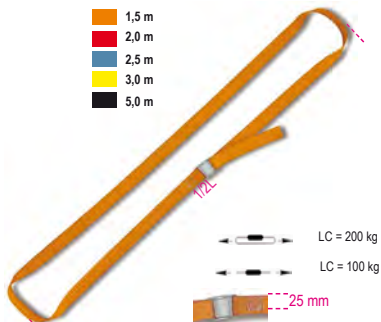

EN 12195-2

L	€	U	U
1,5	2,89	10	081880215
2,0	3,10	10	081880220
2,5	3,50	10	081880225
3,0	3,70	10	081880230
5,0	4,70	6	081880250

8188F35

Spanbanden met gesp, LC 500 kg,
duurzaam polypropyleen (PP) band



EN 12195-2

L	€	U	U
5	10,50	1	081880295

8188FG2

Spanbanden met 2 haken,
LC 250 kg
Duurzaam polypropyleen (PP) band



EN 12195-2

L	L1	L2	€	U	U
3	450	110	14,90	1	081881530

8188/K8

Spanbanden set met 8 accessoires



8188/K8	€	U	U
	44,50	1	081880801

8488K	0,65m - 7kg
8488K	0,80m - 7kg
8188CL	4m - 500kg
8188FP	2,5m - 250kg

8189

Polyester spanband (PES)
met ratel



H	L	LC	€	U	U
25	100	750	101,50	1	081890902
35	100	1000	128,50	1	081890903
50	100	2000	206,00	1	081890905

8189A

Anti-slip mat
voor het fixeren van lading



L	H	S	U	€	U	U
5	250	8	0,6	71,00	1	081890525

8189PA

2 hoekbescherming
voor polyester banden

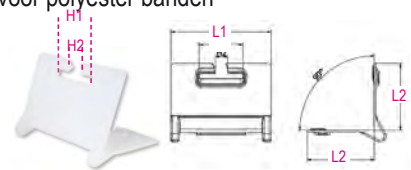

L1xL2	H1	H2	€	U	U
135x90	60	18	4,50	1	081890090

 **Robur**

Item	Test Rapport 2.2 (UNI EN 10204)	Test Certificaat 3.1(UNI EN 10204)	Certificaat fabrikant	CE Verklaring conformiteit
8001Z	✓	✓		✓
8001TZ	✓	✓		✓
8002ZD	✓			
8003ZD	✓			
8004ND	✓			
8005Z	✓			✓
8005TZ	✓			✓
8006Z	✓			✓
8007Z	✓			✓
8008N	✓			✓
8008TZN	✓			✓
8009FD	✓			
8009Z	✓			✓
8009TZ	✓			✓
8010Z	✓			✓
8010TZ	✓			✓
8011Z	✓			✓
8011TZ	✓			✓
8015	✓		✓	✓
8016	✓			✓
8016DA	✓			✓
8016FR	✓			
8016U2	✓		✓	✓
8016UGK	✓		✓	✓
8018E	✓			
8018T	✓			
8020A	✓			
8021A	✓			
8025	✓	✓		✓
8026A	✓	✓		✓
8026R	✓	✓		✓
8028	✓	✓		✓
8029R	✓	✓		✓
8031R	✓	✓		✓
8032	✓	✓		✓
8040EN	✓	✓		✓
8040EZ	✓	✓		✓
8042EN	✓	✓		✓
8042EZ	✓	✓		✓
8041	✓	✓		✓
8043	✓	✓		✓
8044	✓	✓		✓
8048	✓			
8049	✓	✓		✓
8049A	✓	✓		✓
8049V	✓	✓		✓
8051S	✓	✓		✓
8052	✓	✓		✓
8057R	✓	✓		✓
8058R	✓	✓		✓
8060R	✓	✓		✓
8061R	✓	✓		✓
8062	✓	✓		✓
8063	✓	✓		✓
8063SL	✓	✓		✓
8064S	✓	✓		✓
8065SC	✓	✓		✓
8068S	✓	✓		✓
8074	✓			
8074A	✓			
8074G	✓			
8080	✓			
8080FM	✓			
8085R	✓	✓		✓
8086	✓	✓		✓

Item	Test Rapport 2.2 (UNI EN 10204)	Test Certificaat 3.1(UNI EN 10204)	Certificaat fabrikant	CE Verklaring conformiteit
8090	✓	✓		✓
8090F	✓	✓		✓
8090R	✓	✓		✓
8091			✓	✓
8091SL			✓	✓
8092			✓	✓
8092SL			✓	✓
8094			✓	✓
8094SL			✓	✓
8096			✓	✓
8096SL			✓	✓
8097			✓	✓
8097SL			✓	✓
8098			✓	✓
8098SL			✓	✓
8100	✓	✓		✓
8105	✓	✓		✓
8109	✓	✓		✓
8110	✓			
8114	✓			
8116	✓			
8120 - 8120D	✓			
8120B	✓			
8121MZC	✓			
8134	✓		✓	✓
8135	✓		✓	✓
8143	✓		✓	✓
8146	✓		✓	✓
8146C	✓		✓	✓
8147C-S-P	✓		✓	✓
8148	✓		✓	✓
8149	✓		✓	✓
8150	✓		✓	✓
8153	✓		✓	✓
8156	✓		✓	✓
8157	✓		✓	✓
8158	✓		✓	✓
8159	✓		✓	✓
8160	✓		✓	✓
8161	✓		✓	✓
8166	✓			
8170	✓		✓	✓
8173	✓		✓	✓
8176	✓		✓	✓
8177	✓		✓	✓
8178	✓		✓	✓
8179M-B-A	✓		✓	✓
8180	✓			
8181	✓			
8181S	✓			
8182	✓			
8182A-GD	✓			
8182E	✓			
8182H-H2	✓			
8182M	✓			
8182S	✓			
8182T	✓			
8182T-TS	✓			
8182TS	✓			
8185	✓			
8186	✓			
8187	✓			
8188C	✓			
8188CG/25	✓			
8188CU	✓			

Item	Test Rapport 2.2 (UNI EN 10204)	Test Certificaat 3.1(UNI EN 10204)	Certificaat fabrikant	CE Verklaring conformiteit
8188F	✓			
8188VF/35	✓			
8188FG2	✓			
8190	✓	✓		
8190B	✓		✓	
8302Z	✓			
8303Z	✓			
8317DZ	✓			
8317SZ	✓			
8381SL	✓			
8381SP	✓			
8383C	✓			
8383P	✓			
8515V	✓			
8515Z	✓			
8531	✓			
8532	✓			
8535	✓			
8201T	✓			
8205	✓			
8206	✓			
8207	✓			
8209	✓			
8210	✓			
8210F	✓			
8210FTP	✓			
8216	✓			✓
8220	✓			
8225	✓			
8227	✓			
8228	✓			
8240	✓			
8240F	✓	✓		✓
8242	✓			
8242F	✓	✓		✓
8248	✓			
8249	✓			
8249G	✓			
8250	✓			
8264	✓			
8267	✓			
8272	✓			
8273	✓			
8274	✓			
8274A	✓			
8274G	✓			
8276	✓			
8276G	✓			
8278	✓			
8280	✓			
8282	✓			
8282S	✓			
8284	✓			
8285	✓			
8286	✓			
8287	✓			
8290	✓			
8293	✓			
8297C	✓			
8297F	✓			
8381SX	✓			
8702...	✓	✓		
8709...	✓	✓		



Beta Collection

Een verscheidenheid van exclusieve producten zijn ontwikkeld en ontworpen om het karakter van Beta te belichamen. Het bestaat uit meer dan 200 artikelen zoals: sport materiaal, technische kleding en een verscheidenheid van afgestemde producten. Een ideaal middel voor promotionele activiteiten en een must voor ontspannings momenten.



9500TL

Softshell jas, vervaardigd uit 100% polyester, 320 g/m², drielaags, microvezel buitenzijde, waterafstotend, ademend membraan, fleecе voering



Maat	Artikelnummer
S	1 095000051
M	1 095000052
L	1 095000053
XL	1 095000054
XXL	1 095000055

9501TL

Vrouwen sweatshirt, vervaardigd uit katoen (80%) en polyester (20%), 320 g/m²



Maat	Artikelnummer
S	1 095010061
M	1 095010062
L	1 095010063
XL	1 095010064

9501TL

Mannen sweatshirt, vervaardigd uit katoen (80%) en polyester (20%), 320 g/m²



Maat	Artikelnummer
S	1 095010051
M	1 095010052
L	1 095010053
XL	1 095010054
XXL	1 095010055

9502TL

Polo shirt, 100% pique katoen, 210 g/m²



S	1	095020051
M	1	095020052
L	1	095020053
XL	1	095020054
XXL	1	095020055

9505TL

Bodywarmer 100% polyester buitenmateriaal, waterafstotend behandel, gewatteerd 100 g/m², binnezak



S	1	095050051
M	1	095050052
L	1	095050053
XL	1	095050054
XXL	1	095050055

9534WO

poloshirt met twee knopen, gemaakt van jersey katoen, 200 g/m², wit met oranje inzetstukken



S	1	095340031
M	1	095340032
L	1	095340033
XL	1	095340034
XXL	1	095340035

9503TL

T-shirt, 100% jersey katoen, 160 g/m²



S	1	095030051
M	1	095030052
L	1	095030053
XL	1	095030054
XXL	1	095030055

9572LB

T-shirt Beta-March, 100% katoen, 200 g/m² oranje, met zwarte inzetstukken



S	1	095720801
M	1	095720802
L	1	095720803
XL	1	095720804
XXL	1	095720805

9534BO

poloshirt met twee knopen, gemaakt van jersey katoen, 200 g/m², blauw met grijze inzetstukken



S	1	095340071
M	1	095340072
L	1	095340073
XL	1	095340074
XXL	1	095340075

9504TL

Jas met 100% polyester buitenmateriaal, waterafstotend behandeld



S	1	095040051
M	1	095040052
L	1	095040053
XL	1	095040054
XXL	1	095040055

9510W

heren stretch overhemd, lange mouwen, 120 g/m², 97% katoen, 3% elastaan. Wit, met zwart logo. Achterpand met twee zijplooien, semi-Franse kraag. Witte knopen, twee manchetknopen. Slim fit



XS	1	095100100
S	1	095100101
M	1	095100102
L	1	095100103
XL	1	095100104
XXL	1	095100105

9537TL

Fleece pullover, 100% polyester



S	1	095370051
M	1	095370052
L	1	095370053
XL	1	095370054
XXL	1	095370055



9580S

Zonnebril

CE



EN ISO 12312-1:2013+A1:2015
UV400
FILTER CAT. III

9580S

1 095800100

9593S

Smartwatch, touchscreen, fitness tracker, silicone band



9593 S

1 095930200

9593SB

multifunctionele slimme armband, touchscreen, fitness tracker, hartslagmeter, stappenteller, slaapmonitoring, met siliconen band, zwart

Compatibiliteit: IOS 8.2 of hoger/Android 4.4 of hoger
Bluetooth 4.2
IP67

CE



IP67

9593SB

1 095930205

9593M

Automatische horloge, stalen kast, 5 ATM waterbestendig, stalen band



9593M

1 095930120

9593A

Chronograaf horloge, stalen kast, 5 ATM water bestendig, silicone band



9593A

1 095930050

9593W

Analoog horloge, zacht aanvoelend kunststof met metalen ring, 3 ATM waterbestendig, silicone band



9593W

1 095930150



9544C

Handbagage koffer met 4 dubbele wielen, TSA slot, USB port + 3.5-mm greep



9544C

L	S	H
cm	cm	cm
40	20	55

1 095440101

9557J 2.0

Tas, vervaardigd uit gecoate polyester/Oxford 600D polyester stof, afmetingen 47x28x25 cm



9557J 2.0

L	S	H
cm	cm	cm
47	25	28

1 095570020

9541F

Rugzak vervaardigd uit gecoate polyester/
Oxford 600D polyester stof, afmetingen
50x33x16 cm



	L	S	H	
	cm	cm	cm	
9541F	33	16	50	1 095410011

9541PC

werkruugzak, multipocket-stijl, met computervak
aan de binnenkant,
gemaakt van 100% polyester

- rugzak met 3 compartimenten, elk met waterdichte buitenrijs
- eerste compartiment met laptop-vak
- gewatteerde handgreep aan de bovenkant
- USB-poort
- zijvak van mesh voor fles/paraplu
- inzet voor bril op schouderband
- verstelbare borstband



	L	S	H	
	cm	cm	cm	
9541PC	34	18	52	1 095410041

9541S

Rugzak met versteviging, vervaardigd uit
waterafstotend 210D polyester, 33x45 cm



	L	H	
	cm	cm	
9541S	33	45	1 095410031

9541BIKE

Rugzak vervaardigd uit Oxford polyester,
afmetingen 41x24x16 cm



	L	S	H	
	cm	cm	cm	
9541BIKE	24	16	41	1 095410021

95740

Werkhandschoenen, met stretch elastische
manchet, versterkte duim en vingertoppen,
vervaardigd uit een voor touchscreen geschikt
synthetisch leer

CE



M	1	095740202
L	1	095740203
XL	1	095740204
XXL	1	095740205

9574B

Werkhandschoenen, met stretch elastische
manchet, versterkte duim en vingertoppen,
vervaardigd uit een voor touchscreen geschikt
synthetisch leer

CE



M	1	095740102
L	1	095740103
XL	1	095740104
XXL	1	095740105

9525CM

camouflage racepet, 100% polyester,
snapback-stijl



9525CM	1	095250098
--------	---	-----------

9525TR

truckercap met gebogen klep, 50% katoen,
50% polyester, mesh aan de achterkant,
snapback-stijl, zwart



9525TR	1	095250011
--------	---	-----------

9525WB

baseballpet met gebogen klep, 100%
polyester, gaten op de kroon, met
riemversteller, wit



9525WB	1	095251032
--------	---	-----------

9520P

paraplubak, van gegalvaniseerd metaal, met
lasergesneden logo en lekbak, zwart



9520P	1	095200100
-------	---	-----------

9521

Paraplu, vervaardigd uit nylon T210,
aluminium frame bestaande uit 3-secties,
zwart, automatisch open/sluit mechanisme



9521	1	095210000
------	---	-----------

95210B

Paraplu vervaardigd uit nylon 210T, diameter 100 cm



95210B \varnothing 100 cm 1 095210021

9599CB-N2

Atala® stadsfiets, Hi-Ten Tig TTK 700c frame, Shimano Tourney RD-TZ50 derailleur, 6-speed, V-Brakes®, 28" aluminium velgen, met bagagedrager, standaard en bel, mat zwart



9599CB-N2 1 095990031

9597TRIOWAY

TRIOWAY by ATALA® extra stuwkrachtsysteem, elektrisch, kan worden gehaakt aan REHA COMFORT rolstoel (meegeleverd), lithiumbatterij ingebouwd in frame, stuur met richtings- en snelheidsregelaar, met ingebouwd rolstoelaanhaaksysteem

CE



BESCHIKBAAR OP AANVRAAG



KADER

- Snel haak-/lossysteem voor rolstoel met hendel
- Opvouwbaar frame met dubbele scharnieren
- Verticaal verstelbaar stuur
- Schijfrem, 180 mm
- LED-licht vooraan
- Voorwiel met rubberen band

PRESTATIE

- Instelbare snelheid, tot 15 km/u
- Vooruit- en achteruitknop
- Bereik: 20 km
- Versnellingshendel op het stuur

ACCU

- 7Ah oplaadbare lithiumbatterij
- Batterij ingebouwd in frame, verwijderbaar
- 230V 50Hz oplaadkabel (meegeleverd)

ACCESSOIRES

- Multifunctioneel display, met batterijrestcapaciteit en laadniveau-indicator
- Bel
- Richtingaanwijzers
- Mobiele telefoonhouder (meegeleverd)
- Aan / uit knop
- Voorgeïnstalleerd SNELHAAKSYSTEEM ONDER ROLSTOEL

REHA COMFORT ROLSTOEL (inbegrepen)

- Opvouwbaar frame met dubbele scharnieren
- 24" wielen met massieve PU-banden
- Afneembare armlenningen
- Verstelbare, afneembare treeplanken
- Nylon zitting met achterzak

9597TRIOWAY

1 095970200

Beta

9599CB-WN

Atala® stadsfiets, aluminium frame, Shimano® Shifter met 6 versnellingen, V-Brake® remmen, 28" aluminium velgen, grijs

- Aluminium frame
- Hi-Ten Tig TTK 700c vork
- Shimano Tourney RD-TZ50 shifter met 6 versnellingen
- Aluminium V-brake remmen
- 28 aluminium velgen



9599CB-WN 1 095990024

TRIOWAY BY ATALA®

9598W-N

Whistle® mountainbike, aluminium frame, Suntour XCT30 vork, 29" 100 mm, Shimano RD-TX500 derailleur, 7-speed, hydraulische Shimano BR-M200 remmen en 29" aluminium velgen, fluorescerend oranje / mat antracietgrijs



9598W M-N 1 095980130
9598W L-N 1 095980132

9598WHP-N

Whistle® mountainbike, aluminium frame, Suntour XCM PL vork, 29" 100 mm, met remote lockout, Shimano XT RD-M8100 Shadow Plus derailleur, 12-speed, hydraulische Shimano BL-MT201/BR-MT200 remmen en 29" aluminium velgen, wit / mat rood



9598WHP M-N 1 095980140
9598WHP L-N 1 095980142

Beta

9539CB

Beschermende fiets en mountain bike helm met afneembare kin bescherming - maat instelbaar



S-M	1 095390010
L-XL	1 095390011

9542M

Fietsshirt, korte mouwen uit ademende microfiber stof, lang, bedekte rits, drie achterzakken, waarvan een met rits, silicone elastiek aan uiteinde



S	1 095420051
M	1 095420052
L	1 095420053
XL	1 095420054
XXL	1 095420055
XXXL	1 095420056

9542C

Lycra bib broek, silicone elastiek aan pijpuiteinde, antibacteriele zitinleg



S	1 095420061
M	1 095420062
L	1 095420063
XL	1 095420064
XXL	1 095420065
XXXL	1 095420066

9542GW

Winterjack, vervaardigd uit een sterk ventilerend, windstopper geweven stof; lange ritssluiting, silicone-vrije elastische heupband; aanpasbare sluiting van Lycra manchetten; reflecterende inzetstukken achter; 3 achterzakken, waarvan 1 met ritssluiting



S	1 095420101
M	1 095420102
L	1 095420103
XL	1 095420104
XXL	1 095420105
XXXL	1 095420106

9542G

Winterjack, ademende stof, naden binnenin, lange rits, drie achterzakken, silicone elastiek aan onderzijde



S	1 095420012
M	1 095420013
L	1 095420014
XL	1 095420015
XXL	1 095420016
XXXL	1 095420017

Beta

9542S

Winter onderbroek, rekbaar Lycra, antibacteriel, sterk ventilerend gevoerd zitinleg



S	1 095420022
M	1 095420023
L	1 095420024
XL	1 095420025
XXL	1 095420026
XXXL	1 095420027

9542AT

Windstopper bodywarmer, ademende gevoerde stof, lange ritssluiting



S	1 095420072
M	1 095420073
L	1 095420074
XL	1 095420075
XXL	1 095420076
XXXL	1 095420077

9542AL

Waterafstotende windvanger, lange mouwen, vervaardigd uit ademende stof



S	1	095420042
M	1	095420043
L	1	095420044
XL	1	095420045
XXL	1	095420046
XXXL	1	095420047

9543C

Ronde neksjaal, multifunctioneel, 100% polyester microfiber, naadloos



	L	H		
	cm	cm		
9543C	25	50	1	095430100

9523T

"thermische fles, gemaakt van roestvaststaal, 500 ml, dubbellaagse technologie, geen lucht tussen wanden, lekvrije dop, Oranje

- houdt koude dranken 24 uur koud
- houdt warme dranken 12 uur warm



EC1935/EC2023

	ml	L		
		mm		
9523T	500	255	1	095230050

9528B

polyethyleen fles, 500 ml



9528B	ml		1	095280005
	500			

9597P

Fietspomp met manometer

- Adapter voor alle type binnenband ventielen (Schrader, Presta/Sclaverand, Regina)
- Max. 12 bar/ 180 psi



9597P	1	095970100
-------	---	-----------

9524SC

Miniatuur Beta garage voor verzamelaars



1:18	1	095240018
------	---	-----------

9548KB

Loopfiets, staal frame, 12" wielen met binnenband; aanbevolen voor kinderen vanaf 3 jaar; maximale gewicht: 30 kg



9548KB	1	095480110
--------	---	-----------

9548KB 20

Atala® 20" kinder mountainbike, Hi-Ten Tig 20" stalen frame, 30 mm verende voorvork, RD-TY21SS 6V derailleur, aluminium V-brakes en 36-gaats aluminium velgen, fluorescerend geel / mat blauw"



9548KB 20	1	095480120
-----------	---	-----------

9548KB 24

"Atala® 24" kinder-mountainbike, Hi-Ten Tig 24" stalen frame, verende voorvork, Shimano Tourney RD-TYZ50 6V derailleur, aluminium V-brakes en 36-gaats aluminium velgen, mat fluorescerend oranje"



9548KB 24	1	095480122
-----------	---	-----------

9547WSK

"Kinder Werk Bank", werkbank met gereedschap, voor kinderen vanaf 3 jaar

CE



	H			
	cm			
9547WSK	74	1	095473801	

9547T

"Kinder trolley", gereedschapswagen speelgoed, voor kinderen vanaf 3 jaar, compleet met gereedschap

CE



9547T	1	095470100
-------	---	-----------



9548G

"Kinder Garage", 6-verdiepings, met auto wasserij, lift en opritten



9548 G H cm 69 1 095480100

9561V 2,5

Beach vlag 2.5x0.50 m met aluminium paal, kruisvoet met verzwaarde ring



9561V 2,5 L mt 0,50 H mt 2,5 1 095610200

9561VV 2,5

Beach vlag, 2x0.50 m, met paal



9561VV 2,5 L mt 0,50 H mt 2,5 1 095610201

9561VV

Beach vlag, 3.50x0.75 m, met paal



9561VV 4,0 L mt 0,75 H mt 3,50 1 095610101

9561V

Beach vlag, 4x0.75 m, met verchroomde metalen mast, betonnen voet, 50 cm



9561V L mt 0,75 H mt 4 1 095610001

9559

Banner, TNT; modules: 3x0.8 m



9559 L m 3 H m 0,8 1 095591001

9559/30MT

Vliesstof rol met 10 Beta logos



9559/30MT 1 095591031

9590B

Vlag, vervaardigd uit bedrukt nylon 140 x 215 cm



9590B L cm 215 H cm 140 1 095900000



9577R

werkoverall, race-stijl, gemaakt van 4-weg stretch stof, 260 g/m², zwart en oranje, met witte en reflecterende inzetstukken

CE



Maat	L	H	Artikelnummer
S	48		1 095770151
M	50		1 095770152
L	52		1 095770153
XL	54		1 095770154
XXL	56		1 095770155
XXXL	58		1 095770156

9579C

Werkjack, polyester/katoen



Maat	L	H	Artikelnummer
M			1 095791002
L			1 095791003
XL			1 095791004

9565T

Plaatstalen vat/tafel met een gevernist multiplex topblad.

Geleverd met een dubbel set van verhogingsbuizen (7 cm of 20 cm) voor hoogte verstelling.



9565T	H cm	Ø cm		
	95→108	70	1	095650200

9565S

Plaatstalen vat met krukjes voorzien van afneembare imitatie leren kussens



9565S	H cm	Ø cm		
	60	38	1	095650300

9565K

Vat tafel met twee krukjes



9565K	H cm	Ø cm		
	95	70	1	095650500

Beta

9563G

bureau stoel, voor gasten



9563G				
			1	095630050

9563U

Bureau stoel, ergonomisch



9563U				
			1	095630020

9549ABW

draadloze BT V5.0 oortjes, met ingebouwde microfoon, draadloos opladen, USB-C oplaadstation, zwart

CE



9549ABW	L mm	H mm	S mm		
	61	34,5	41	1	095490091

9549SBW

draadloze BT-speaker, draagbaar, 6 functies

"BT-versie 5.0"

FUNCTIES:

- BT afspelen
- TF-kaart spelen
- USB-afspelen
- audio-aansluiting 3,5 mm
- radio FM
- oproepfunctie

CE



9549SBW	L mm	S mm	H mm		
	73	73	124	1	095490072

9549BP

Powerbank, 10000mAh



9549BP					
				1	095490052

9549CR

4-in-1 multi-oplaadkabel, gemaakt van gevlochten nylon, snellaadoptie

• USB type A voedingsconnector

- Lightning-connector voor Apple-apparaten
- Micro-USB-oplaadconnector
- USB-C-oplaadconnector
- USB-C oplaad- en datatransmissieconnector



9549CR	L mm				
	120			1	095490042

9549MPC

oplaadstation met meerdere poorten, 6 USB-poorten, voor meerdere keren opladen tot een maximaal opgenomen vermogen van 65 W

CE



9549MPC	L mm	S mm	H mm		
	110	72	35	1	095490082

Beta

9549BRW

draadloos oplaadstation,
met snellaadfunctie en laadniveau-indicator

- Geleverd met USB-USB Type C-kabel, voor aansluiting op transformator, 1 m lang
- Compatibel met alle apparaten die draadloos opladen ondersteunen
- Ingang: DC 5V/2A, 9V/2A, 12V/1.5A
- Uitgang: 5W/ 7,5W/10W/ 15W

CE



9549BRW Ø mm 58 H mm 6 1 095490100

9549C

USB stick, 32 GB



9549C 1 095490062

9547

Bureau calculator

CE



9547 1 095470000

9594

Klok met thermometer en hygrometer, 26 cm
in diameter



9594 Ø cm 26 1 095940051

9526F

minikoelkast, energie-efficiëntieklasse F,
inhoud 63 l, zwart

CE



9526F 1 095260005

9526P

Espresso koffie apparaat voor capsules

Geschikt voor Lavazza™ en Espresso Point™ capsules
voor professioneel gebruik.



9526P 1 095260010

9527 6T

6-delig set koffierkopjes



9527 6T 1 095270001

9522A

Flesopener met ergonomische handgreep



9522A 1 095220010

9523A

Aluminium waterfles, 500 ml



9523A ml 500 1 095230005

9586K

Multifunctioneel stalen mes,
10 functies



9586K 1 095860100

9526RMN

Set van 2 van 55 rummy speelkaarten van
Modiano®



9526RMN 1 095260010

9592B/C50

Set van 50 pennen



9592B/C50 1 095920050

9592B/P

Pennen met opdruk



9592B/P 500 095920051

9592MB

Parker® balpen



9592MB 1 095920060

Beta
Quality Tools

9592M/50

Set van 50 pennen



9592M/50

1 095920100

9588M

Zacht foam inleg met 1 pen en 2 notitieblokken



9588M

1 095880011

9596

Sleutel/kaart houder, polyester met metalen klip en mobiele telefoonkoord



9596

10 095961001

9595C

Leren sleutelhanger



9595C

1 095950011



9595T

Metalen verchroomde sleutelhanger, in fluwelen etui



9595T

1 095950021

9569P

Draagtas, vervaardigd uit polyethyleen, opgevouwen zijkant



9569P

L cm 34 H cm 44 50 095691001

9569S

TNT shopper tas, uitklapbaar, 38x42 cm



9569S

L cm 38 H cm 42 50 095690051

9569MS-2

Shopper tas, vervaardigd uit slijtvast polypropyleen



9569MS-2

L cm 45 H cm 40 5 095690055

9569MS

Shopper tas, vervaardigd uit duurzaam polypropyleen, met dubbele hengsels



9569MS

L cm 60 H cm 40 5 095690052

9587 9x14

Notitieboek, 9x14 cm



9587 9X14

L cm 9 H cm 14 5 095870009

9587 13x21

Notitieboek, 13x21 cm



9587 13X21

L cm 13 H cm 21 5 095870013



9588S/10...

Set van 10 notitieblokken



9588S/10A 21x29 cm	1	095881001
9588S/10B 15x21 cm	1	095881002
9588S/10C 10x15 cm	1	095881003
9588S/10D 7,5x10,5 cm	1	095880054

9588/10PI

Set van 10 notitieblokken met plakstrip



9588S/10PI 7,5x7,5 cm	1	095880055
--------------------------	---	-----------

9589A/36

36 rollen of plakband met Beta logo. Bruin



9589A/36	1	095890035
----------	---	-----------

9589B/36

36 rollen of plakband met Beta logo. Wit



9589B/36	1	095890036
----------	---	-----------

9562TB

Vloermat voor het passen van schoenen, met anti-slip, onderkant voorzien van rubber laag



9562TB	L mm	H mm	1	095620500
	800	600		

9562T2

Werkplaats mat, 200x160 cm

- Beschermt de vloer tegen olie en benzine vlekken, milieu vriendelijk
- Eenvoudig te reinigen, anti slip, onderkant mat voorzien van rubberlaag.



9562T2	L cm	H cm	1	095620200
	200	160		

9562T1

werkplaats mat 100x80cm

bijzonder geschikt voor gebruik onder motor bandenlichters BETA 3071 en 3071B*

- gemakkelijk te reinigen, antislip rubber gecoate oppervlak



9562T1	L cm	H cm	1	095620150
	100	80		

9562T3

Werkplaats mat
Afmetingen: 300x160 cm

- Uitermate geschikt voor het gebruik onder motorfietsen
- Beschermt de vloer tegen olie en benzine vlekken, milieu vriendelijk
- Eenvoudig te reinigen, anti-slip, onderkant mat voorzien van rubber



9562T3	L cm	H cm	1	095620300
	300	160		

9562P2

Logo mat, 200x80 cm

- Zeer geschikt voor in de werkplaatsinrichting C55 of onder motorfietsen



9562P2	L cm	H cm	1	095620400
	200	80		

9562P12

Rol multilogo mat, 12 m x 80 cm

De gewenste mat lengte is zelf aan te passen



9562P12	L m	H cm	1	095620425
	12	80		



VERWIJDERD ARTIKEL - VERVANGEND/ AANBEVOLEN ARTIKEL

	VERWIJDERD ARTIKEL
	VERVANGEND ARTIKEL
	AANBEVOLEN ARTIKEL

96AS 5/8	000960736		
96AS 3/4	000960738		
97BTX 50	000970150		
97BTX 55	000970155		
98XZN 14	000980014		
98XZN 16	000980016		
310/1	003100001		
310/C4	003100104		
353N	003530201		
353NM 10	003530210		
353NM 12	003530212		
353NM 14	003530214		
353NM 16	003530216		
353NM 18	003530218		
353NM 22	003530222		
353N/C6	003530300		
386A/3	003860003	386A/1	003860001
386A/4	003860004	386A/2	003860002
386A3/RC	003860013	386A1/RC	003860011
386A4/RC	003860014	386A2/RC	003860012
412 C3,00	004120288		
412 C3,25	004120289		
412 C3,50	004120290		
412 C4,00	004120292		
412 C4,50	004120294		
412 C5,00	004120296		
412 C5,50	004120298		
412 C6,00	004120300		
412 C6,50	004120301		
412 C7,00	004120302		
412 C7,50	004120303		
412 C8,00	004120304		
415 C3,00	004150288		
415 C3,25	004150289		
415 C3,50	004150290		
415 C4,00	004150292		
415 C4,50	004150294		
415 C5,00	004150296		
415 C5,50	004150298		
415 C6,00	004150300		
415 C6,50	004150301		
415 C7,00	004150302		
415 C7,50	004150303		
415 C8,00	004150304		
420A M3	004200003		
420A M4	004200004		
420A M5	004200005		
420A M6	004200006		
420A M8	004200008		
420A M10	004200010		
420B M3	004200053		
420B M4	004200054		
420B M5	004200055		
420B M6	004200056		
420B M8	004200058		
420B M10	004200060		
437K/10	004370030		
666N/2	006660002	666/2	006660702
666N/2X	006660003	666/2X	006660703
666N/5	006660005	666/5	006660705
666N/10	006660010	666/10	006660710
666N/10X	006660011	666/10X	006660711
666N/20	006660020	666/20	006660720
666N/30	006660030	666/30	006660730
666N-LBF.IN/5	006660055		
666N-LBF.IN/10	006660070		

666N-LBF.IN/10X	006660071		
666N-LBF.IN/20	006660072		
666N-LBF.IN/30	006660073		
666HS/5	006664005	666ZR-HS/5	006664705
666HS/10	006664010	666ZR-HS/10	006664710
666HS/20LC	006664021	666ZR-HS/20LC	006664721
666HS/30LC	006664031	666ZR-HS/30LC	006664731
667N/20	006670020	667/20	006670720
667N/30	006670030	667/30	006670730
667N/40	006670040	667/40	006670740
956L 20,8	009560221		
960S 22	009600022		
960T/D	009600035		
960T/E	009600036		
960T/I	009600040		
960T/L	009600041		
960T/M	009600042		
960BT/B 29	009600128		
960AVL	009600210		
960CMB	009600250		
960CMB/R2	009600252		
960CMD	009600270		
960CMD/R1	009600271		
960BC 25	009600285		
960BC 27	009600287		
960BC/P 28	009600288		
960BC 29	009600289		
960BC 30	009600290		
960EPC	009600790		
960SN 11	009600837		
960SN 12	009600838		
1044F 250	010440015	1044N 250	010440025
1044 250	010440250	1044N 250	010440025
1044FK 250	010449015	1044NK 250	010449025
1044K 250	010449250	1044NK 250	010449025
1134A/RL	011340145		
1150MQ 160	011500096	1150MQ 160	011500496
1150MQ 180	011500098	1150MQ 180	011500498
1150MQ 200	011500100	1150MQ 200	011500500
1150MQ 220	011500102	1150MQ 220	011500502
1229LP 1,0	012290210		
1229LP 1,2	012290212	1257LP 1,2	012570012
1229LP 1,4	012290214		
1229LP 1,8	012290218	1257LP 1,8	012570018
1229LP 2,0	012290220	1257LP 2,0	012570020
1229LP 2,4	012290224		
1229LP 3,0	012290230	1257LP 3,0	012570030
1229PH 0	012290250	1257PH 0	012570063
1229PH 1	012290251	1257PH 1	012570066
1366S	013660000	1366SH	013660400
1366S-KIT	013660001		
1438DCT	014380300		
1461C5G	014610053		
1461/C6B	014610063		
1461/C6G	014610064		
1461/C7B	014610072		
1461/C8B	014610083		
1461/C9B	014610092		
1461/C11A	014610111		
1461/C12A	014610123		
1461/C13B	014610134		
1461/C18B	014610182		
1461/C29B	014610209		
1461/C20G	014610221		
1461/C21G	014610222		
1461/C23B	014610224		
1461/C24B	014610225		
1461/C25G	014610226		
1461/C27G	014610228		
1461/C28B	014610229		
1461/C30G	014610231		

1461/C32G	014610233		
1461/C33B	014610234		
1462/KD	014620060		
1462/KMRC	014620070		
1462PIM	014620502		
1468N/1	014680011		
1468N/2	014680012		
1468N/3	014680013		
1478/3P	014780151		
1486/10	014860110		
1486/20	014860120		
1486/30	014860130		
1486/40	014860140		
1486/50	014860150		
1486/60	014860160		
1486/70	014860170		
1486/80	014860180		
1486/90	014860190		
1493 68-L14	014930206		
1493 75/77-L15	014930212		
1493 76-L8	014930214		
1493 95-L15	014930244		
1493AL 94,5-L15	014930345		
1493AL/CF 27	014930427		
1498TC	014980450		
1696A 800	016960108		
1716Q	017160010		
1739B	017390151	1739C	017390152
1740A	017400101	1740AN	017400103
1742	017420001	1742N	017420002
1742/C4	017420005	1742N/C4	017420006
1742KR M3	017420043	1742N/KR M3	017420063
1742KR M4	017420044	1742N/KR M4	017420064
1742KR M5	017420045	1742N/KR M5	017420065
1742KR M6	017420046	1742N/KR M6	017420066
1742A	017420100	1742AN	017420101
1742A/C	017420105	1742AN/C	017420106
1742A/KR M5	017420143	1742AN/KR M5	017420155
1742A/KR M6	017420144	1742AN/KR M6	017420156
1742A/KR M8	017420145	1742AN/KR M8	017420158
1742A/KR M10	017420146	1742AN/KR M10	017420160
1751NR	017510110		
1752 700	017520007		
1752R	017520020		
1753 200	017530002		
1753 300	017530003		
1753 500	017530005		
1753 700	017530007		
1753R	017530020		
1755 30	017550003		
1755 80	017550008		
1755 150	017550015		
1834RR	018340520		
1840BM	018400101		
1882	018820010	1882N	018820110
1883	018830035	1883N	018830036
1889	018890200	1889N	018890220
1915B 11X16	019150013		
1915C 11X16	019150016		
1915D 11X16	019150018		
1927PAL	019270009		
1946T	019460021	1946	019460001
1949BC/RU	019490122	1949BC/RUL	019490123
1972/12	019720012	1972/K12V-10	019720112
1984/18QM	019840018	1984/K600	019840060
2009ID	020090103	2109MT ID/1	021091026
2032TEL/A	020321314		
2051N	020510215	2051N	020510225
2258-O	022580011	2258N-O	022580021
TV250	024000408		
TV290	024000455	TV294	024000491
TV255	024000467		

VERWIJDERD ARTIKEL - VERVANGEND/ AANBEVOLEN ARTIKEL

	VERWIJDERD ARTIKEL
	VERVANGEND ARTIKEL
	AANBEVOLEN ARTIKEL

TV79	024000490		
TV121	024000767	TV122	024000768
T13	024240013		
T53	024240053		
T57	024240057		
T79	024240079		
T121	024240121	T122	024240122
T250	024240250		
T256	024240256		
T285	024240285	T279	024240279
T289	024240289	T294	024240294
T289	024240289	M294	024500294
TV57	024249907		
TV13	024249913		
M285	024500285		
M289	024500289		
MV115	024510115	MV116	024510116
MV285	024510285		
MV289	024510289	MV294	024510294
MM61	024580061		
MM140	024580141		
MMV61	024590061		
MMV142	024590142		
3008	030080100	3008N	030080110
3025	030250001	3025N 1,0	030250110
3025/PF	030250011	3025N/PF	030250111
3025/RF	030250901		
3025/RG	030250902		
3027 10	030270010	3027N 10	030270101
3027 20	030270020	3027N 20	030270102
3027 30	030270030	3027N 30	030270103
3027 50	030270050	3027N 50	030270105
3027 100	030270100	3027N 100	030270110
3027/KP10	030270510	3027N/KP10-20	030270511
3027/KP20	030270520	3027N/KP10-20	030270511
3027/KP30	030270530	3027N/KP30	030270531
3027/KP50	030270550	3027N/KP50	030270541
3027/KP100	030270551	3027N/KP100	030270552
3027/KPP50	030270555	3027N/KPP50	030270565
C45LMP	054000320	5000 RSC50/PLED	050001714
C54S-G	054000302		
C54S-R	054000303		
C55C	055000400		
C58M/PA	058000350		
5910VG/3T	059101068		
5945VU/M	059451001	5945VUM	059451011
5980ID	059801085	5980ID/1	059801086
C62M/W	062000360	C62M/WW	062000362
6200M/B	062000361		
7195A	071950004		
7200BKK 35	072000235		
7200BKK 36	072000236		
7200BKK 37	072000237		
7200BKK 38	072000238		
7200BKK 39	072000239		
7200BKK 40	072000240		
7200BKK 41	072000241		
7200BKK 42	072000242		
7200BKK 43	072000243		
7200BKK 44	072000244		
7200BKK 45	072000245		
7200BKK 46	072000246		
7200BKK 47	072000247		
7200BKK 48	072000248		
7201BKK 35	072010435		
7201BKK 36	072010436		

7201BKK 37	072010437		
7201BKK 38	072010438		
7201BKK 39	072010439		
7201BKK 40	072010440		
7201BKK 41	072010441		
7201BKK 42	072010442		
7201BKK 43	072010443		
7201BKK 44	072010444		
7201BKK 45	072010445		
7201BKK 46	072010446		
7201BKK 47	072010447		
7201BKK 48	072010448		
7210BKK 35	072100335		
7210BKK 36	072100336		
7210BKK 37	072100337		
7210BKK 38	072100338		
7210BKK 39	072100339		
7210BKK 40	072100340		
7210BKK 41	072100341		
7210BKK 42	072100342		
7210BKK 43	072100343		
7210BKK 44	072100344		
7210BKK 45	072100345		
7210BKK 46	072100346		
7210BKK 47	072100347		
7210BKK 48	072100348		
7212LG 34	072120134		
7212LG 35	072120135		
7212LG 36	072120136		
7212LG 37	072120137		
7212LG 38	072120138		
7212LG 39	072120139		
7212LG 40	072120140		
7212LG 41	072120141		
7212LG 42	072120142		
7214LN 34	072140134		
7214LN 35	072140135		
7214LN 36	072140136		
7214LN 37	072140137		
7214LN 38	072140138		
7214LN 39	072140139		
7214LN 40	072140140		
7214LN 41	072140141		
7214LN 42	072140142		
7216BKK 35	072160335		
7216BKK 36	072160336		
7216BKK 37	072160337		
7216BKK 38	072160338		
7216BKK 39	072160339		
7216BKK 40	072160340		
7216BKK 41	072160341		
7216BKK 42	072160342		
7216BKK 43	072160343		
7216BKK 44	072160344		
7216BKK 45	072160345		
7216BKK 46	072160346		
7216BKK 47	072160347		
7216BKK 48	072160348		
7224PEK 35	072240235		
7224PEK 36	072240236		
7224PEK 37	072240237		
7224PEK 38	072240238		
7224PEK 39	072240239		
7224PEK 40	072240240		
7224PEK 41	072240241		
7224PEK 42	072240242		
7224PEK 43	072240243		
7224PEK 44	072240244		
7224PEK 45	072240245		
7224PEK 46	072240246		
7224PEK 47	072240247		

7224PEK 48	072240248		
7225PEK 35	072250135		
7225PEK 36	072250136		
7225PEK 37	072250137		
7225PEK 38	072250138		
7225PEK 39	072250139		
7225PEK 40	072250140		
7225PEK 41	072250141		
7225PEK 42	072250142		
7225PEK 43	072250143		
7225PEK 44	072250144		
7225PEK 45	072250145		
7225PEK 46	072250146		
7225PEK 47	072250147		
7225PEK 48	072250148		
7235BK 35	072350335		
7235BK 36	072350336		
7235BK 37	072350337		
7235BK 38	072350338		
7235BK 39	072350339		
7235BK 40	072350340		
7235BK 41	072350341		
7235BK 42	072350342		
7235BK 43	072350343		
7235BK 44	072350344		
7235BK 45	072350345		
7235BK 46	072350346		
7235BK 47	072350347		
7235BK 48	072350348		
7239B 39	072390339		
7239B 40	072390340		
7239B 41	072390341		
7239B 42	072390342		
7239B 43	072390343		
7239B 44	072390344		
7239B 45	072390345		
7239B 46	072390346		
7239B 47	072390347		
7239B 48	072390348		
7248GK 35	072480235		
7248GK 36	072480236		
7248GK 37	072480237		
7248GK 38	072480238		
7248GK 39	072480239		
7248GK 40	072480240		
7248GK 41	072480241		
7248GK 42	072480242		
7248GK 43	072480243		
7248GK 44	072480244		
7248GK 45	072480245		
7248GK 46	072480246		
7248GK 47	072480247		
7248GK 48	072480248		
7293HN 39	072930839		
7293HN 40	072930840		
7293HN 41	072930841		
7293HN 42	072930842		
7293HN 43	072930843		
7293HN 44	072930844		
7293HN 45	072930845		
7293HN 46	072930846		
7293HN 47	072930847		
7294HN 39	072940839		
7294HN 40	072940840		
7294HN 41	072940841		
7294HN 42	072940842		
7294HN 43	072940843		
7294HN 44	072940844		
7294HN 45	072940845		
7294HN 46	072940846		
7294HN 47	072940847		

VERWIJDERD ARTIKEL - VERVANGEND/ AANBEVOLEN ARTIKEL

	VERWIJDERD ARTIKEL
	VERVANGEND ARTIKEL
	AANBEVOLEN ARTIKEL

7310CRK 35	073100335		
7310CRK 36	073100336		
7310CRK 37	073100337		
7310CRK 38	073100338		
7310CRK 39	073100339		
7310CRK 40	073100340		
7310CRK 41	073100341		
7310CRK 42	073100342		
7310CRK 43	073100343		
7310CRK 44	073100344		
7310CRK 45	073100345		
7310CRK 46	073100346		
7310CRK 47	073100347		
7310CRK 48	073100348		
7340B 36	073400236		
7340B 37	073400237		
7340B 38	073400238		
7340B 39	073400239		
7340B 40	073400240		
7340B 41	073400241		
7340B 42	073400242		
7340B 43	073400243		
7340B 44	073400244		
7340B 45	073400245		
7340B 46	073400246		
7340B 47	073400247		
7341N 36	073410236		
7341N 37	073410237		
7341N 38	073410238		
7341N 39	073410239		
7341N 40	073410240		
7341N 41	073410241		
7341N 42	073410242		
7341N 43	073410243		
7341N 44	073410244		
7341N 45	073410245		
7341N 46	073410246		
7341N 47	073410247		
7349RP 38	073490138		
7349RP 39	073490139		
7349RP 40	073490140		
7349RP 41	073490141		
7349RP 42	073490142		
7349RP 43	073490143		
7349RP 44	073490144		
7349RP 45	073490145		
7349RP 46	073490146		
7349RP 47	073490147		
7350RP 38	073500138		
7350RP 39	073500139		
7350RP 40	073500140		
7350RP 41	073500141		
7350RP 42	073500142		
7350RP 43	073500143		
7350RP 44	073500144		
7350RP 45	073500145		
7350RP 46	073500146		
7350RP 47	073500147		
7423 39/42	074230002		
7423 43/46	074230004		
7429 39/42	074290002		
7429 43/46	074290004		
7635N XS	076350500	7636N XS	076360500
7635N S	076350501	7636N S	076360501
7635N M	076350502	7636N M	076360502
7635N L	076350503	7636N L	076360503

7635N XL	076350504	7636N XL	076360504
7635N XXL	076350505	7636N XXL	076360505
7635N XXXL	076350506	7636N XXXL	076360506
7658N S	076580001		
7658N M	076580002		
7658N L	076580003		
7658N XL	076580004		
7658N XXL	076580005		
7658N XXXL	076580006		
7904N XS	079040800	7750N XS	077500000
7904N S	079040801	7750N S	077500001
7904N M	079040802	7750N M	077500002
7904N L	079040803	7750N L	077500003
7904N XL	079040804	7750N XL	077500004
7904N XXL	079040805	7750N XXL	077500005
7904N XXXL	079040806	7750N XXXL	077500006
7904N XXXXL	079040807	7750N XXXXL	077500007
7907P XS	079070600		
7907P S	079070601		
7907P M	079070602		
7907P L	079070603		
7907P XL	079070604		
7907P XXL	079070605		
7907P XXXL	079070606		
7907P XXXXL	079070607		
7930G XS	079300300	7930MG XS	079300400
7930G S	079300301	7930MG S	079300401
7930G M	079300302	7930MG M	079300402
7930G L	079300303	7930MG L	079300403
7930G XL	079300304	7930MG XL	079300404
7930G XXL	079300305	7930MG XXL	079300405
7930G XXXL	079300306	7930MG XXXL	079300406
7931G XS	079310300	7931MG XS	079310400
7931G S	079310301	7931MG S	079310401
7931G M	079310302	7931MG M	079310402
7931G L	079310303	7931MG L	079310403
7931G XL	079310304	7931MG XL	079310404
7931G XXL	079310305	7931MG XXL	079310405
7931G XXXL	079310306	7931MG XXXL	079310406
7933G XS	079330300	7935MG XS	079350400
7933G S	079330301	7935MG S	079350401
7933G M	079330302	7935MG M	079350402
7933G L	079330303	7935MG L	079350403
7933G XL	079330304	7935MG XL	079350404
7933G XXL	079330305	7935MG XXL	079350405
7933G XXXL	079330306	7935MG XXXL	079350406
7935G XS	079350300		
7935G S	079350301		
7935G M	079350302		
7935G L	079350303		
7935G XL	079350304		
7935G XXL	079350305		
7935G XXXL	079350306		
7939G XS	079390300		
7939G S	079390301		
7939G M	079390302		
7939G L	079390303		
7939G XL	079390304		
7939G XXL	079390305		
7939G XXXL	079390306		
7980N 58	079800058	7981N 58	079810158
7980N 60	079800060	7981N 60	079810160
7980R	079800111	7980RN	079800120
7985	079850111	7985N	079850000
8016FR-6K 3	080169753		
8016FR-4K 5	080169755		
8016FR-4K 6	080169756		
8016FR-4K 8	080169758		
8062 22-25	080620025		
8130A 10X900	081300209		
8131Z-8 6X800	081310060		
8131DL 10X900	081310209		

8135/KCA 0,75	081350630		
8135/KCA 1,0	081350635		
8135/KCA 2,0	081350640		
8135/KCA 3,0	081350645		
8135/KCA 5,0	081350650		
8135/KGF 0,75	081350705		
8135/KGF 1,0	081350710		
8135/KGF 2,0	081350720		
8135/KGF 3,0	081350730		
8135/KGF 5,0	081350750		
8135/KGM	081350805		
8135/KGM 1,0	081350810		
8135/KGM 2,0	081350820		
8135/KGM 3,0	081350830		
8135/KGM 5,0	081350850		
8139Z 8	081390008		
8139DL 14	081390214		
8139ZCH	081390909		
8149S/A	081490510		
8149S/B	081490512		
8149S/C	081490515		
9508TL S	095080051		
9508TL M	095080052		
9508TL L	095080053		
9508TL XL	095080054		
9508TL XXL	095080055		
9515M S	095150051		
9515M M	095150052		
9515M L	095150053		
9515M XL	095150054		
9515M XXL	095150055		
9515M XXXL	095150056		
9516B S	095160051		
9516B M	095160052		
9516B L	095160053		
9516B XL	095160054		
9516B XXL	095160055		
9516B XXXL	095160056		
9525TL	095250010	9525TR	095250011
9525F	095250099	9525CM	095250098
9525B	095251031	9525WB	095251032
9527MUG	095270020	9599CB-WN	095990024
9557N	095570001		
9565BBQ	095650100		
9565ICE	095650400		
9595 C25	095950031		
9599CB-W	095990023		
9599 GARAGE-S	095999011		
9599 GARAGE-M	095999012		
9599 GARAGE-L	095999013		
9599 GARAGE-XL	095999014		
9599 GARAGE-XXL	095999015		
C99T	099000492		
C99M	099000494		
C99T-V3	099000497		
C99P-V3	099000498		
11204C 40	112040204		
11204C 60	112040206		
11210C 40	112100204		
11210C 60	112100206		
11216C 40	112160204		
11216C 60	112160206		
11220C 40	112200204		
11220C 60	112200206		
11234B 40	112340104		
11234B 60	112340106		
11435 M-80	114350008		
11435 M-120	114350012		
11435 F-150	114350015		
11435 F-180	114350018		



Accu gereedschap	313÷321
Aftekenkoord en kalkpoeder	218
Afzet palen met ketting	668
Allesknippers	136÷137, 241, 295, 312
Aluminium opstap	238
Amperemeter klemtang	234
Automatische haspels met inspectielampen	314÷318
Automatische slanghaspel voor perslucht of koud water	347
Automobiel gereedschappen	118÷125, 160÷166, 170÷208, 229÷238
Azijnzuur-uithardende siliconenkit	565
Bankschroeven parallel	209
Beitels, koud	10, 125, 218, 292, 300, 304, 312
Beitels, rits	10
Beitels, steen	217
Beschermhoezen voor gereedschapswagens	393
Beta BM	588÷594
Beta chemicaliën	562÷567
Beta Collection	715÷726
Beta schuur en slijpmateriaal	568÷584
Bindstrips Nylon	590÷593
Bindstriptang	594
Bit voor boren, tappen en verzinken	47
Bits en bithouders	78÷85, 155, 287
Blister verpakking	595÷609
Boren, puntlas	41
Boren, spiraal	36÷40
Borgdraadtangen	236
Borstel	225
Boutenscharen	134, 310
Brekmessen	238÷239
Centerpunten	9
C-klemmen	209
Contactlijm	565
Conusdoorslag	44
Digitale oliemeter	256
Doorslagen	9, 304
Dopschroevendraaiers	113÷114, 288
Dopsleutels, toebehoren en assortimenten, 1"	110÷111
Dopsleutels, toebehoren en assortimenten, 1/2"	99÷109, 288, 308
Dopsleutels, toebehoren en assortimenten, 1/4"	86÷93
Dopsleutels, toebehoren en assortimenten, 3/4"	109÷110, 308÷309
Dopsleutels, toebehoren en assortimenten, 3/8"	93÷99, 287÷288, 307
Draadherstel roestvast stalen	46÷47
Dubbele ringsleutels voor verzonken moeren	17, 306
Elektrische transportwagen	398
Elektrische producten	585÷594
Elektronische momentsleutel tester	69
Enkele en dubbele steeksleutels	13÷15, 282, 286, 293, 305
EVOX-E elektrische schroevendraaier	148
Extra platte beitel met zijlemmet	161
Felsapparaat	32
Fiets gereedschap	280÷284
Fietstakels	281÷282
Flexibele grijpers	219
Flexibele magneet	219
Gatzagen en toebehoren	51÷53
Geïsoleerde gereedschappen, 1000V	285÷291
Gereedschap met valbeveiliging	292÷298



Gereedschaphouder met riem	354÷355
Gereedschaps assortimenten	479÷532
Gereedschaps assortimenten in inlegbakken	533÷558
Gereedschaps rugzak	358
Gereedschaps toebehoren voor kasten, laden en panelen	559÷561
Gereedschapsborden	405, 430, 451, 470
Gereedschapskasten	402
Gereedschapskasten, plaatstaal	433÷435; 452; 473÷474
Gereedschapskisten	361, 363
Gereedschapskisten met laden	368÷370, 392
Gereedschapskoffers	351÷357, 364÷366
Gereedschapstassen	354÷361
Gereedschapswagen met laden	371÷380, 386÷394, 421÷422, 443÷444, 462÷465
Gereedschapswagen open	380÷382, 397÷400, 448, 469
Gradenboog	61
Haakse bithouder	85
Haakse stiftsleutels voor binnenzeskant en Torx® aansluiting	18÷23
Haakse stiftsleutels voor binnenzeskant en Torx® aansluiting met handgreep	21÷23, 293, 301
Haakse stiftsleutels met XZN® profiel	23
Haaksleutels	23÷24, 307
Hamers	162, 166÷169, 296÷297, 302, 310÷311
Hamers kunststof	169÷170, 297, 311
Handmatige lieren en accessoires	694, 699
Handschoenen isolerend	291
Handtappen en assortimenten	44÷47
Harpsluitingen	680÷682
Heteluchtpistool	325
Hijsbanden en hijskabels	706÷709
Hijskettingen	685÷689
Hoekmeter, precisie	213
Hoekmeters	213
Holpijpen	135÷136
Holpijptang	236
Houder voor slagmoersleutel	333
Houtzaag	224
Hydraulische pomp	163
Hydraulische vijzels	208
Inlegbakken, zacht foam	533÷558
Insulerende mat	291
Inspectie spiegels	219
inzetstukken 4mm	150
Isolatie mantels	594
Isolatie tape	594
Kabel en draadstriptangen	138÷139
Kabelbinders met klittenband	593
Kabelkniptang	138, 289
Kabelscharen , industrieel	135
Kabelschoentang	585÷587
Kantzettang	132
Ketting-Rateltakels	692÷693
Kisten	360÷363
Kitspuiten	227
Klapmessen	239÷240, 312
Knie beschermmat	263
Kniegewrichtsleutels	15
Koevoet vonkvrij	312
Koevoeten	123, 218, 309
Koffers, verrijdbaar	355÷356, 359÷361, 395÷396



Kogellagertrekkers	198÷204
Kraaienpoot sleutels 3/8"	96
Krachtvermeerderaars	54÷56
Kraspennen	215
Kroonklemmen	590
Kruipolie	565
Kunststof herstel apparaat	166
Ladenkast	384÷385
Lamellenslijpschijven	576÷580
Lamellenstiften	581÷583
Lampen	242÷247
Lasapparaat, inverter	252÷253
Laser afstandsmeter	215÷216
Lashelm, LCD automatisch	254
Lasmagneten	253
Lasspiegels voor recht en stoplassen van kunststof pijp	28
Lastangen	253
LED schijnwerper	244
Lijmpistolen elektrisch	325
Lijmtangen	209
Linialen	214, 297
Loodgieter gereedschappen	27÷35
Magnetische gereedschaphouder	238, 264
Magnetische lasklemmen	253
Magnetische schijven voor het optillen van metalen platen	253
Magnetiseer en demagnetiseer	144
Meetklokken	212
Micrometers	211
Milieu meters	236
Moerenspijter	219
Moflasapparaat	27÷28
Mokers	169, 311
Momentschroevendraaiers	60
Momentsleutels	62, 66÷68
Momentsleutels met ratel	57÷69
Moniertangen	134
Motorfiets gereedschap	274÷279
Multifunctioneel spuitvet	565÷566
Multimeters	232÷233, 297
Nylon kabeltrekker	587
Oliekannen	228÷229
Oliepistool	256
Oliepomp	256
Oliespuit	229
Ontdooi spray	567
Oogbouten	682÷685
Opblaasbare wiggen	241
Open ringsleutels	17
Opzetwagen voor kisten	369
Papierrolhouders	377÷378
Passers	214
Pendrijvers	9, 278, 304
Pijpenbuigers	34÷35
Pijpenklemmen	35
Pijpentangen	33÷34, 294, 301, 307
Pijpruimers	31
Pijpsleutels gebogen zeskant/twaalfkant	112÷113, 294, 309
Pijpsleutels recht gesmeed	112÷113, 118

Pijpsnijders met ratel voor PVC pijpen	30
Pijpsnijders.	28÷32, 307
Pincetten	126÷127, 289
platenklemmen	692
Pneumatisch gereedschap en toebehoren	327÷350
Pomblind klinktangen met nagels	225÷227
Ponstang	132
Powertools	313÷324
Powertools	322÷325
Priemen	220
Puntkousen	680, 702
Radiatorsleutel	31
Ratel sleutels	25÷27, 294
Reinigingsmiddelen	566÷567
Remmenreiniger	566÷567
Ringabelschoen	589
Ringsleutels	15÷17, 286, 293, 305÷306
Ringsteeksleutels	11÷13, 25÷26, 294, 300, 305
Robur kabel toebehoren	671÷714
Roestvast stalen gereedschappen	299÷303
Roestvaststaal kabel toebehoren	700÷706
Rolbandmaat	215÷216
Schuurvliesrol	584
Schakelkastleutels	210
Scharen	135÷136
Scharen elektricien	136÷137, 289, 295
Schraapmes	173, 184, 220, 239
Schroefdraadafdichting	563
Schroefdraadborgmiddel	563
Schroefdraadmeter	218
Schroevendraaiers klingen	155÷156
Schroevendraaiers BetaEVOX	145÷148
Schroevendraaiers BetaGrip	152÷156
Schroevendraaiers BetamaX	157÷159
Schroevendraaiers haaks	149
Schroevendraaiers klem	149
Schroevendraaiers micro	150÷151
Schroevendraaiers slag.	158÷159
Schroevendraaiers slagvast	149
Schuifmaten	210÷211
Siliconenspray	566
Slag steeksleutels	14÷15, 305÷306
Slagdoppen, toebehoren en assortimenten	70÷78
Slijpschijven	570÷572, 583
Slijpstiften	573÷576
Snijplaten en sets	47÷51
Soldeerbouten	250÷252
Spanbanden	706, 710÷713
Spanningszoeker	150
Spanschroeven	672÷677
Spatels	224, 312
Spuitbushouders	377÷378, 477
Staalkabel klemmen	678÷679
Stof en waterzuigers	325÷326
Straalkalibers	218
Tangen, borgveer	128÷129, 173, 294÷295, 309
Tangen, combinatie	139÷140, 289, 296, 310
Tangen, elektronica	142÷143



Tangen, grip	130÷132, 193, 295
Tangen, knip voor elektronica	143÷144
Tangen, telefoon lang en extra lang	127÷128, 140÷143, 289÷290, 296, 310
Tangen, zij en kopknip	133÷134, 289, 295, 301
Tap en taphouders	46, 49
Tapeinduithalers	171÷172
Thermometers	235
Timmersmans potlood	215
Tinzuigers	252
Toerenmeter, digitaal	235
Transportkoffers	364÷367
Transportwagen, inklapbaar	367, 398
Trapboren	41
Trekkers drie armig	200÷202, 208
Trekkers hydraulisch	208
Trekkers twee armig	198÷204, 208
T-sleutels met binnenzeskant en Torx® aansluiting	115÷117, 287, 309
T-sleutels voor zeskant en Torx® moeren	114, 116÷117
Ultrasonisch reinigingstank	260÷261
Veertrekker	224
Veiligheidsbril	669
Veiligheidsschoenen	624÷649
Verfspuiten	347
Verrijdbare werkbank	383
Verstelbare moersleutels	24, 286, 293, 301, 307
Vetafgiftepomp	228
Vetspuiten	227
Videoscoop elektronisch	122
Vijlen	161, 220÷224, 312
Vijlenborstel	224÷225, 312
Vlakafdichting	564
Vloeibare pakking	564
Vloeistof afzuigapparaat	256
Vloermat	263, 276, 291, 409, 726
Voelermaten	219
Voltage tester	193
Vonkvrij gereedschap	304÷312
Vonkvrije bijl	312
Vonkvrije schep	312
Vonkvrije veiligheidsklep sleutel	309
Voorhamers	169, 311
Waarschuwingstekens	668
Wanden voor verkoop	610÷623; 669÷670
Warenpassen	216÷217
Warmtebeeld camera	236
Waterdichtmakende spray	567
Waterpomptangen	129÷132, 289, 295, 310
Werkbanken	401, 403÷409, 415÷420, 462÷464
Werkkleding	650÷670
Werkplaatsinrichting	410÷478
Wielnaaftrekkers	202÷203
Winkelhaken	212÷213
Zaagbeugels en zaagbladen	224
Zaklampen	242÷243
Zinkspray	567
Zitkruk, verrijdbaar	262÷264
Zuignappen	237

Automotive



Accu en laadsysteem tester, digitaal	197÷198
Acculaders	195÷197
Accupool reiniger	225
Accuvuller	229
Accuzuur weger, glazen behuizing	231
Airbag gereedschappen	172
Aircondition service apparaat	257÷259
Antivries meter, glazen behuizing	231
Assteunen	266
Auto frontbeschermer	263
Auto-interieur/exterieur reinigingsgereedschap	255, 262, 346, 609
Autoradio demontageset	237
Autoruit demontage	237
Bandenhoezen	124
Bandenkanon	346
Bandenlepels	122÷123, 283
Bandenspanningsmeter	345÷346
Bekledingskrammen tang	236
Bekledingstang	182
Bekledingstangen	192÷193
Bougie sleutels en dopsleutels	118÷119
Bougiekaptang	181
Brandstofleidingtang	185
Carrosserie voelermaten	162
Carrosseriespatel, roestvast staal	161
Carrosserievijl, met vijlblad	161
Carterplug dopsleutel	191÷192
Compressietester voor benzinemotoren	122
Deukentrekker	162÷164
Diagnose werkplaats wagen	397
Diesilverstuiver dopsleutels	119
Diesilverstuivers tester met manometer	122
Digitale tester voor druk en compressie	175
Dopsleutels voor bladveren	206
Dopsleutels voor uitlaatgas sensor	120÷121
Elektronisch apparaat voor het vervangen van remvloeistof	177
Geleiderpennin voor wielen	124÷125
Gereedschap voor airco, brandstof leidingen	186
Gereedschap voor common rail injectoren	121
Gereedschap voor het verwijderen van contacten	193
Gereedschap voor het verwijderen van gloeispiralen	121



Gereedschap voor vullen van dieselfilters	184
Gerredschap voor het verwijderen van draagarm rubber	208
Handtassen	160÷161
Hefboom voor draagarmen en schokdempers	207
Hefboom voor DSG koppeling	172
Homokineet trekker	207
Ketting breek en klinkgereedschap	278
Klem voor slangen	184
Klepadichtring tang	174
Kleppenslijper, pneumatisch	173
Klepstel en poelieblokkeer set	175
Klepveerlichter	173
Koelsysteem testapparaat	231
Koppeling centreer apparaat	172
Krik en bandenplaatser	266
Kruissleutels	124
Lambda sonde dopsleutels	119
Ligmaat, verrijdbaar	263÷265
Lucht hydraulische krik	273
Matrijzen voor parkeersensoren	165÷166
Momentbegrenzer voor wielmoeren	77
Motorensteun	267
Naafmoer dopsleutels	123
Olie en dieselfilter doppen	190
Oliefiltersleutels	187÷191
Olieopvangentanken	255÷256
Olieservice apparaat voor automaat.	259÷260
Open dopsleutels voor brandstofleiding	174
Pakkingverwijderaar	203
Palletwagen	273
Pneumatische uitdeuktrekker	164
Potcricks, hydraulisch	266
Profielmeter voor banden	218
Reflectieplaat	163
Reinigingstank	261÷262
Remschijf schuifmaat	210
Remveertang	178
Remzuiger draaigereedschap	178
Ruimers voor injector zittingen	121
Seegerringtang	173
Signaal detector	234
Slagbus voor conische lagers	208
Slagdoppen voor wielen	72÷73
Slagdoppen, vierkant voor Isuzu wielen	76
Slangklemtang	179÷180

INDEX AUTOMOBIEL GEREEDSCHAPPEN



Sleutel voor turbo	182
Spannings stabilisator	198
Spotter apparaat	164
Standaards voor wegmotoren	274÷275
Startboosters	194÷195
Stethoscoop	198
Straalcabine	261
Stuurkogeltrekkers	207
Stuurstang verwijdersleutel	207
Systeemreinigingsmachine	262
Tankdopsleutels	185
Telescopische steun	238
Transmissiekrik, hydraulisch	267÷268
Trechter, kunststof	229÷230, 312
Trechter,aluminium vormbaar	230
Trekhaak	171
Trekkers voor VW bobines	181
Uitdeukhamers	162
Uitdeuklepel, gebogen	161
Uitlaat snijtang	182
Veerspanner, pneumatisch	205
Ventielgereedschap	124÷125
Verrijdbare werkbank voor versnellingsbak	400
Vloeistofopvangbak	255÷256
Voertuigverplaatser	266
Voertuigverplaatser	265
Voltage tester	193
Werkplaats krik	271÷272
Werkplaatskraan, opvouwbaar	267
Werkplaatspers, hydraulisch	269÷270
Wielbout afdekkap tang	124
Wielgewichttang	125
Zijruit trekker met handgreep	237
Zuigerveerklemmen	173

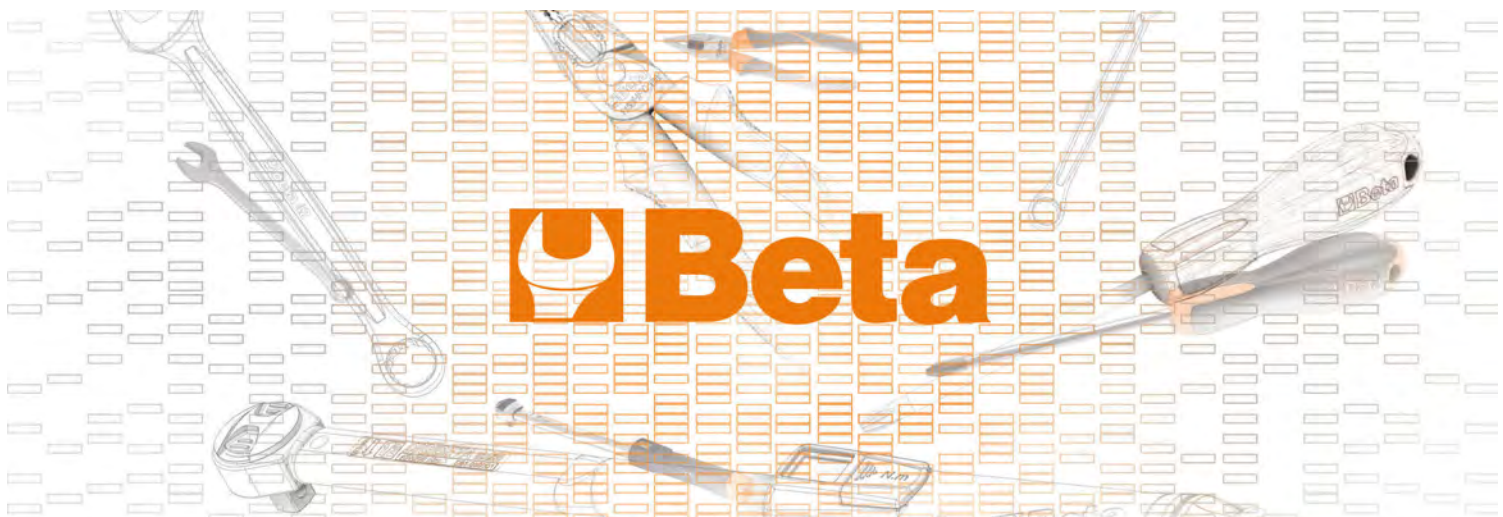

ALFANUMERISCHE INDEX

1

		1010	128 1078	132 1122K	601 1150GBMK	602
		1010BM	128 1080D	132 1123	136 1150GK	602
100	24	1010MQ	289 1081	133 1123K	601 1150HPC	140
100/KIT	24	1031/S4	128 1082	133 1124	136 1150K	602
110BA	307	1032	128 1082BA	310 1124K	601 1150MQ	289
110MQ	286	1032BA	309 1082BM	133 1125	136 1153	140
111CM	24	1032K	600 1082BMK	600 1126	136 1162	140
111E	24	1033	128 1082G	133 1127	136 1162BA	310
111EN	24	1033K	600 1082GBM	133 1128BAX	136 1162BM	141
111ER	24	1034	128 1082GBMK	600 1128BM	137 1162BMK	602
120	25	1034K	600 1082GK	600 1128BMX	136 1162G	141
120/B6N	25	1034L	129 1082K	600 1128BMX/F	136 1162GBM	141
123/K4	25	1036	129 1082MQ	289 1128BMX	601 1162GBMK	602
123/K4	597	1036BA	309 1084	133 1128BSX	137 1162GK	602
123E1/4	25	1036K	600 1084BM	133 1128BSX	601 1162K	602
123Q1/2	25	1037	129 1084BMK	601 1128FX	137 1162MQ	289
123Q1/4	25	1037K	600 1084G	133 1128FXS	137 1164	141
123Q3/8	25	1038	129 1084GBM	133 1128MQ	289 1164BM	141
141	25	1038K	600 1084GBMK	601 1129BM	137 1164BMK	602
141/B	25	1039	129 1084GK	601 1129BMK	601 1164K	602
141/S	25	1044N	129 1084K	600 1130BMX	137 1164MQ	289
142	25	1044NK	600 1084MQ	289 1130BMX	602 1166	141
142/B	26	1046BA	310 1088	133 1131CK	137 1166BA	310
142/S	26	1047	129 1088BM	133 1132	138 1166BM	141
142/SC9I-E	26	1047BM	129 1088BMK	601 1132BM	138 1166BMK	603
142AS	26	1048BM	130 1088K	601 1132BMK	602 1166G	141
142AS/S	26	1048MQ	289 1088MQ	289 1132K	602 1166GBM	141
142C	26	1048N	130 1092V	134 1132MQ	289 1166GBMK	603
142C/A	26	1048N/D3	130 1094V	134 1133	138 1166GK	603
142K	597	1048NK	600 1095N	134 1133RL	138 1166K	602
142MC	26	1048VN	130 1096	134 1134	138 1166MQ	289
142MC/SC9I-E	26	1048VNK	600 1096K	601 1134A	138 1168	141
142SN	26	1050	130 1098	134 1134RL	138 1168BM	142
142SN/S	26	1051	130 1098K	601 1137BA	310 1168BMK	603
142SN/SC9	26	1051GM	130 1098PL	134 1137BA/RC	310 1168G	141
186	27	1051L	130 1098PLK	601 1142BM	138 1168GBM	142
187	27	1051XL	130 1100BA 600	310 1142BMK	602 1168GBMK	603
187/B5	27	1052	130 1101	134 1142MQ	289 1168GK	603
188	27	1052BA	310 1101R	134 1143	138 1168K	603
192	27	1052K	600 1102	134 1143R	138 1168MQ	290
192/S2	27	1053	131 1103	134 1144D	138 1169/D3	142
192/S2	597	1054	131 1103R	134 1144D/RG	138 1169BM/D3	142
194	27	1055	131 1104	135 1144D/RL	138 1169G/D3	142
195	27	1055D	131 1104R	135 1144G	138 1169GBM/D3	142
195/B5	27	1056	131 1105	135 1144G/RL	139 1169MQ/D2	290
195AS	27	1057A	131 1105/C10T	135 1144L	139 1169N/D4	142
195AS/B	27	1058	131 1105/C16T	135 1144T	139 1171BM	142
195K	597	1059	131 1105/C32T	135 1148A	139 1172BM	142
195P	27	1060	131 1105AD-50	135 1148A/R	139 1172BM/P	143
195P/B5	27	1061	131 1105T20	135 1148B	139 1173BM	143
1002	127	1062	131 1105T30	135 1148B/R	139 1175BM	143
1008	127	1062AL	132 1105T50	135 1148P	139 1177BM	143
1008BM	127	1062GM	132 1112	135 1149F	139 1177BM/Z	143
1009	127	1063	132 1112K	601 1149F	602 1178BM	143
1009L/A	127	1064	132 1114	136 1150	139 1178BM/P	143
1009L/B	127	1065F	132 1118	136 1150BA	310 1182BM	143
1009L/C	127	1065P	132 1120A	136 1150BM	140 1183BM	144
1009L/D	128	1066	132 1120ARL - ARG	136 1150BMK	602 1184BM	144
1009L/DP	128	1067	132 1122	136 1150G	139 1185BM	144
1009L/DP-S2	128	1077	132 1122 - 1125MOL	136 1150GBM	140	

ALFANUMERISCHE INDEX

1186BM	144	1253A	150	1267TX/D7	155	1293BX/DA	614	1360G	162
1188BM	144	1254	150	1267TX/S13	155	1293BX/DD	614	1361/C12	162
1190BM	144	1254	604	1267TXK	604	1293BX/DE	614	1361/K9	162
1191BM	144	1256/20	150	1268RTX	155	1293BX/DF	614	1362B	163
1191BM/L	144	1256/30	150	1268RTX/S8	155	1293ES	158	1364SCP	163
1191R/5-M	144	1256/C36-2	150	1268RTXK	604	1293ES/S7	158	1364SE	163
1200MS	144	1256LP	150	1269N/PZ	155	1294	158	1364SP	163
1201E	145	1256PE	150	1269N/PZK	604	1294/S7	158	1364SR	163
1201E/DZ	146	1256PH	150	1269PZ	155	1294K	605	1364SV	163
1201E/K	603	1256PZ	150	1269PZ/S4	155	1294L	158	1365/K13	163
1201E/S6	145	1256RTX	150	1269PZK	604	1295	158	1365P10	163
1201EN	145	1256TX	150	1270BA	310	1295/C14	159	1366/K5	164
1201EN/K	603	1257BE	151	1272BA	310	1297TX	159	1366A	163
1202E	146	1257ES	151	1272MQ	290	1297TX/D6	159	1366B	164
1202E/K	603	1257ESB/S8	151	1272MQ/S	290	1297TX/L	159	1366KF	164
1202E/S4	146	1257LP	150	1272MQF	290	1297TX/L-S5	159	1366S/R1	164
1202EL	146	1257LP/S	151	1273MQ/D6	290	1297TX/S12	159	1366S/R10	165
1202EN	146	1257LPH/S8	151	1273MQ/E1	614	1298RTX	159	1366S/R11	165
1202EN/K	603	1257PH	151	1273MQ/E4	614	1298RTX/S8	159	1366S/R12	165
1203/E10P	612	1257TX	151	1273MQF/D6	290	1298RTXK	605	1366S/R13	165
1203/E1P	612	1257TX/S	151	1274MQ	290	1299N/PZ	159	1366S/R14	165
1203/E4P	612	1260	152	1274MQ/S	290	1299N/PZK	605	1366S/R2	164
1203/E5P	612	1260/S6	152	1274MQF	290	1299PZ	159	1366S/R21	165
1203E/D	146	1260E	153	1275MQ/C	290	1299PZ/S6	159	1366S/R22	165
1203E/S	146	1260EK	604	1276MQ/C	291	1299PZK	605	1366S/R24	165
1204E	146	1260K	604	1277BA	310	1302	160	1366S/R25	165
1204E/K	603	1260MC	153	1279MQ	291	1303	160	1366S/R26	165
1204E/S5	146	1260N	152	1279MQ/F	291	1304	160	1366S/R3	164
1204EL	147	1260NK	604	1279MQ/S	291	1305	160	1366S/R4	165
1205E/ES	147	1262	153	1281/B28A	156	1305Z	160	1366S/R5	165
1205E/ES-S8	147	1262/S4	153	1281BG	155	1306	160	1366S/R6	165
1206E/BP	147	1262E	153	1281BG/A9	156	1307	160	1366S/R7	165
1206E/BP-S7	147	1262EK	604	1281BG/B28NA	156	1308	160	1366S/R8	165
1207E TX/K	603	1262K	604	1281BG-TX/A8	156	1310	160	1366S/R9	165
1207E/TX	147	1262L	153	1281LP	155	1312	160	1366SH	164
1207E/TX-D	147	1262MC	153	1281LPH	156	1314	161	1366SH/C	164
1208E RTX/K	603	1262N	153	1281PB	155	1326	161	1366SL	164
1208E/RTX	147	1262NK	604	1281PE	156	1327	161	1366ST	164
1208E/RTX-D	147	1263/D...	153	1281PH	156	1328	161	1367/K10	166
1209E PZ/K	603	1263/E39	613	1281PM	155	1329	161	1367/K4	166
1209E/PZ	147	1263/E40	613	1281PZ	156	1330	161	1367/S4	165
1209E/PZ-S4	147	1263/E50	613	1281RTX	156	1331	161	1368	166
1209EN/PZ	147	1263/E62	613	1281TX	156	1335BM	161	1368G/C2U	166
1209EN-PZ/K	604	1263/E70	613	1290	157	1337/S5	161	1368G/CV	166
1210E/GE	148	1263/E74	612	1290/S	157	1338	161	1368G/K400	166
1211E/GE	148	1263/E78	612	1290K	605	1338A - 1338B	161	1368G/OD	166
1229LP/S	148	1263/E85	613	1290K/INOX	605	1338R9 - 1338R12	161	1368G/SD	166
1229LPH/A6	148	1263/S12	154	1290N	157	1342	161	1369/C11	167
1236B	149	1263MC/D8	154	1290NK	605	1342PM	161	1370	167
1238B	149	1264	154	1292	157	1342PMR	161	1370/MR...	167
1241	149	1264/S5	154	1292/S4	157	1343	161	1370BA	310
1242	149	1264K	604	1292K	605	1344	162	1370BA/MR	311
1243/D7	149	1264L	154	1292K/INOX	605	1344A/VW	162	1370BA/PL	311
1243/S11	149	1265ES	154	1292L	157	1345	162	1370F	167
1243LP/D6	149	1265ES/S8	154	1292N	157	1351	162	1370F/MR...	167
1250	149	1266BP	154	1292NK	605	1353	162	1370FT	167
1251	149	1266BP/S8	154	1293/D...	158	1357Z/45	162	1370T	167
1252/S5	149	1267MC/TX	155	1293/S...	158	1359T	162	1374F	167
1253	150	1267MC/TX-D7	155	1293BP	158	1360/K6	162	1374F/MR...	167
1253	604	1267TX	154	1293BP/S	158	1360/KP3	162	1375	168

ALFANUMERISCHE INDEX

1375/MR	168	1435/1	172	1467T/C6	178	1477D/S5	182	1488/1	187
1375A	168	1435/1R	172	1467TU	178	1477K/7	182	1488R...	187
1375B	168	1435R	172	1470	178	1478	182	1489/31T	187
1375BA/PL	311	1437/C12	172	1470FT	178	1478/K3	183	1489/33	187
1376X	168	1438	172	1470PF	178	1478NSS	183	1489/33P	188
1376X/MR	168	1438DCT/S	173	1471	178	1478SP	183	1489/C14	188
1376XT	168	1438DSG	172	1471A	178	1478T	183	1489/E	188
1376XT/MR	168	1438EVO	172	1471CF	179	1479	183	1489/Y	188
1377	168	1438K/DSG-2	172	1471CM	179	1479/B27	183	1489R	188
1377/MR...	168	1438K/PWR	172	1471CM/E11	179	1479L/K4	183	1490	188
1377BA	311	1438R	172	1471D2	179	1479L/S2	183	1490/R1 - 1490/R2	188
1377BA/PL	311	1439/K7	173	1471GF	178	1479LB/C5	183	1490F	188
1377T	168	1440/...	173	1471M/50	178	1479LV/S3	183	1491	188
1378	168	1445/1 - 1445/2	173	1471M/C22	178	1479ML/B17	183	1491A	188
1378/MR...	168	1452K	173	1471M/P	178	1479ML/S3	183	1491R	188
1379BA	311	1452PN/K	173	1471M/W50	179	1479N/S5	184	1491T	188
1379F	168	1454P	173	1471PN/B1	179	1479RB/1	184	1492/1 - 1492/2	189
1379F/MR...	169	1455SVP	173	1471PN/B2	179	1479RB/2	184	1492T	189
1380	169	1455SVP/R...	173	1471PN/B3	179	1479RB/3	184	1493	189
1380/MR...	169	1457/B4	173	1471PN/B4	179	1479U/13	184	1493/C19	190
1380BA	311	1458	173	1471PN/B5	179	1479U/32	184	1493/C30	189
1380BA/MR	311	1460F	174	1471PT/C5	179	1480	184	1493/C7	190
1380BA/PL	311	1462/EI	174	1471T/C5	179	1481/C12	184	1493/PF	189
1380S	169	1462/KI	174	1472	179	1481K/S4	184	1493/S-U	191
1380S/MR...	169	1462/KU	174	1472AU	179	1481PL	184	1493AL	189
1380T	169	1462/MB	174	1472AU/P	180	1481PL/S3	184	1493AL 4S	189
1381	169	1462AD/BSC	174	1472AU/RP	180	1481T/C12	185	1493AL CF	190
1381/MR...	169	1462AD/SMN	174	1472B/RNLT	180	1482	185	1493B	189
1381BA	311	1462CF	174	1472FC	180	1482/8 - 1482/10	185	1493B/S5	189
1381BA/MR	311	1462CF/C6	174	1472FC/GE	180	1482A/1	185	1493C/ADB	191
1381BA/PL	311	1462CF-SN	174	1472FC/L	180	1482A/3	185	1493DSG	190
1381T	169	1462CF-SN/C6	174	1472FCA	180	1482A/5	185	1493FF	190
1385	169	1463/KIT	175	1472FCL/RP	180	1482B	185	1493FT	190
1385/MR	169	1464ADB	176	1472H	180	1482C	185	1493H	190
1390	169	1464AP	175	1472MT/VW	180	1482D	185	1493HK	190
1390/MR...	169	1464AP T	175	1472R/AU	180	1482SN	185	1493J	190
1390BA	311	1464AP T16X12	175	1472TM	180	1483K/12	185	1493U/ADB	191
1390BA/R	311	1464APB	176	1472VW	180	1483K/22	186	1493VW	190
1390N	170	1464CBD	175	1473	181	1483KV-PT/S7	81	1493X	191
1390NR	170	1464FAP	176	1473A	181	1484	186	1493Y	191
1390R	170	1464FG	176	1473FN	181	1484PSA	186	1494	191
1391	170	1464FG/CP4	176	1473P	181	1485/KIT	186	1494/C14A	192
1391A	170	1464IC	175	1473T	181	1485BP	186	1494BMW	191
1392	170	1464IC/RK	175	1474/C4	181	1485BPM	186	1494E	191
1392R	170	1464PB	176	1474DL	181	1485FCA/K2	186	1494FPC	191
1393	170	1464PF	177	1474E/VW	181	1485FCA/T	186	1494M	192
1410/M	171	1464PT	176	1474E/VW2	181	1485FCA/TS	186	1494MAN	191
1428	171	1464T	175	1474G	181	1485FRD/T	186	1494MRC	191
1428/SB11	171	1464T/SP80	175	1474L	181	1485MJ	187	1494Q	192
1428L	171	1464TDI	176	1475U	181	1485MRC/T	186	1494T	192
1428L/B3	171	1464VD	176	1476	182	1485PMTJ	187	1494T/C5	191
1429	171	1465	177	1476/RC	182	1485R	187	1494VW	191
1429/SB7	171	1466/C5	177	1476A	182	1485R/P10	187	1494VW/K	192
1430/...	171	1466L 11	177	1476A/RC	182	1485R/P17	187	1494VW/KT	192
1430/S	171	1466TLF	177	1476C/1	182	1485TC	186	1494XZN	192
1431/...	171	1467	177	1476GT	182	1485VAG	187	1495/C6	192
1431/C5	171	1467/RK1	177	1476PSA	182	1485VAG/K2	187	1495M	192
1433	171	1467/RK2	177	1476T	182	1485VLV/T	186	1495T	192
1433/C11	172	1467LF/2	177	1477/C10	182	1487/K2	187	1496/C	192
1435	172	1467LF/RC	177	1477D	182	1488 - 1488L	187	1497/C23	193

ALFANUMERISCHE INDEX

1497/C94	193	1516/1 - 2 - 3	200	1565/1 - 2 - 3	207	1670	213	1703BA/A	312
1497/S3	193	1517	200	1566/GO1	207	1670A	213	1703BA/P	312
1497BS	193	1517C/...	201	1566N	207	1672	213	1703BA/PL	312
1497D	192	1518/...	201	1566P	207	1672A	213	1704	218
1497KB/S3	193	1518U/...	201	1566R	207	1674A	213	1704A	218
1497P	193	1519/...	201	1567	207	1674C	213	1704C	218
1497RC	193	1520/1 - 1520/2	202	1568	208	1676	213	1705	218
1497SS	193	1521/1 - 1521/2	202	1569/F	208	1678/C3	213	1705PT	218
1497TE	193	1528	202	1569/SB	208	1679	213	1706DGT	218
1498	193	1529	202	1569CP	208	1679/PR	213	1707	218
1498/12	195	1529/C7	202	1570/3	208	1680	214	1707A/1 - 2 - 3	218
1498/120A	197	1529/PG	202	1580/8I	208	1680A	214	1708/8 - 13 - 20	219
1498/12-24 R20	195	1529PI	202	1580GL	208	1680B	214	1709/10 - 1709/18	219
1498/16A	196	1530/C16	202	1585/5I - 6I - 7I	208	1680C	214	1710	219
1498/24	195	1530/C5	202	1585GI/5 - 6 - 7	208	1682	214	1712E/1 - 2 - 3	219
1498/25A	196	1531/C7	203	1589PI/50 - 100 - 150	208	1683	214	1712TF	219
1498/2A	195	1532	203	1589VI	208	1685/C7	214	1713M	219
1498/2A-8A-PR	196	1533/...	203	1590	209	1687/S4	214	1713M/K7	219
1498/40A	197	1533PR/1 - 2 - 3	203	1591	209	1687A	214	1714	219
1498/4A	195	1534/...	203	1593	209	1687AC	214	1715	219
1498/4A-8A CO	196	1535/C...	203	1594	209	1687D	214	1715B/R5L	219
1498/4A-8A CP	196	1539	203	1595	209	1687U	214	1715FL/A	219
1498/8A	196	1540	203	1599B	209	1688	215	1715FL/B	219
1498B12/R02	195	1542/1 - 1542/2	204	1599F	209	1688A	215	1715I	219
1498BC/12	194	1544/...	204	1599G	210	1688M	215	1715L	219
1498LT/12	194	1545/C5M	204	1599GI	209	1688PC	215	1715R/FL	219
1498LT/12-24	195	1547/C6	204	1599GR	209	1688PC/R	215	1716A	219
1498LT/12-R7	194	1547KP	204	1599P	209	1690F	215	1716P	220
1498LT/12-SF	194	1547P	204	1599T	209	1690L	215	1716R	220
1498MN/12-C	194	1547PC/2	204	1600Q 10	210	1691BM	215	1716U	220
1498MN/12-P	194	1547PL/2	204	1600Q 10	606	1691MG	215	1717A	220
1498MN/12-R	194	1549	204	1600Q 8	210	1692	215	1717B	220
1498MN/12-U	194	1550U	205	1600Q 8	606	1693	215	1717BA	312
1498PC	198	1550U/CGS-R	205	1602BA	312	1693	606	1717BA/1	312
1498SA/2A-4A	195	1550U/M	205	1603BK	606	1693L	215	1717C	220
1498SM	197	1550U/MRC-ABE	205	1603K	606	1693M	216	1717D	220
1498SM-A	197	1550U/MRC-C	205	1650	210	1694/L	216	1717T	220
1498SM-C	197	1550U/S...	205	1650FD	210	1694A/L	216	1717T RS	220
1498SM-CP	197	1550U/SS187	205	1650FT	210	1694B/L	216	1717T RT	220
1498ST/TB	198	1551/C20	205	1651DGTB	210	1695XS	216	1717V	220
1498ST/TB ROT	198	1552/C9	205	1651DGTB/IP	211	1696	216	1717V R	220
1498TB/12-24	198	1555/Q	206	1652	211	1696A	216	1718A...M	221
1498TB/6-12	197	1555/QS	206	1654	211	1696B	216	1718A...P	221
1499	198	1555C	206	1654DGT	211	1696D	217	1718A...Q	220
1500/...	198	1555S/BMW-RNT	206	1656	211	1696S	217	1718A...R	221
1500/SP	198	1556/1A	206	1657DGT/2	211	1697	217	1718A...S5	221
1500G/...	198	1556/2A	206	1658/...	211	1699L	217	1718A...T	221
1500N/...	198	1557	206	1658/C4	211	1699L/1	217	1718D...M	221
1500N/G...	199	1557/S3	206	1658DGTB	211	1699Q	217	1718D...P	221
1500N/SP	199	1557V	206	1658SP/1	212	1700N	217	1718D...Q	220
1501/1 - 2 - 3	199	1558/C13	206	1659	212	1700N/PM	217	1718D...R	221
1501G/1 - 2 - 3	199	1558/C4	129	1662/1 - 1662/2	212	1701_WARN	218	1718D...S5	221
1501Z/S - P - R	199	1558P	206	1662AN	212	1701BA	312	1718D...T	221
1502/...	199	1559	207	1662DGT/A	212	1701N	217	1719BA12	312
1505/C5	200	1559V/8T	207	1662SP0	212	1701N/PM	217	1719BA8	312
1505V	199	1560/2	207	1662SP2	212	1701NE/...	218	1719BM/RG	223
1506	200	1560A	207	1666	212	1701PMR	218	1719BM/RL	223
1508/1 - 1508/2	200	1561/...	207	1666A	212	1702N	218	1719BM/RP	223
1511/1 - 2 - 3	200	1562D	207	1668	212	1702N/PM	218	1719BM/RR	223
1515/1 - 2 - 3	200	1563/C4	207	1668A	213	1702PMR	218	1719BMA...B5	222

ALFANUMERISCHE INDEX

1719BMA...M	222	1741U	226	1759HD/RR	231	1772M	238	1833M	243
1719BMA...P	222	1742AN	226	1759HD/TRUCK	232	1772R	239	1833MW	243
1719BMA...Q	221	1742AN/C	227	1759LR	232	1772R	607	1833RB-L/USB	242
1719BMA...R	222	1742AN/KR	227	1759TT	232	1772RL/2	239	1833S	243
1719BMA...S5	222	1742N	226	1760/IR1000	235	1773A	239	1833XL	243
1719BMA...T	221	1742N/C4	226	1760/IR1600	235	1773RL	239	1833XS/1	242
1719BMB/P	223	1742N/KR	226	1760/IR500	235	1773S	239	1833XS/2	242
1719BMC	223	1742R-A/M...	226	1760/OHM	233	1773S/RL	239	1833XSW	243
1719BMD...B5	222	1742R-AL/M...	226	1760/RMS	233	1774	239	1834RR	608
1719BMD...M	222	1749	227	1760/RSE	234	1774A	239	1836AW	243
1719BMD...P	222	1749A	227	1760/TC2	235	1774A/RL	239	1836B	243
1719BMD...Q	221	1749A/RB	227	1760B	233	1774S	239	1837C	244
1719BMD...R	222	1749A/RT	227	1760DGT	232	1776BA	312	1837F	243
1719BMD...S5	222	1749AC	227	1760DGT/2	233	1777BM	239	1837F/USB	244
1719BMD...T	221	1750	227	1760DGT-R3	234	1777BMT	239	1837M	244
1719BMR	223	1750CG	227	1760K	235	1777BMT	607	1837RB-F/USB	244
1719BMR/B3	223	1750KG10	228	1760LX	236	1777MQ/C	291	1837S	244
1719BMX...M	222	1750M	228	1760PA/80	234	1777MQ/U	291	1838/11LED	245
1719BMX...P	222	1750M3	228	1760PA/AC	234	1777RL/U	291	1838AM	245
1719BMX...Q	221	1750R/1 - 1750R/2	227	1760PA/AC-DC	234	1777T	239	1838COB	245
1719BMX...R	222	1750RC	227	1760PA/AC-DC2000	234	1777T	607	1838E	246
1719BMX...S5	222	1750RP/1 - 1750RP/2	227	1760PT	235	1778AN	239	1838E-BT	246
1719BMX...T	221	1750RT	227	1760R/TC2	235	1778AX	240	1838FLASH	244
1719R/...	223	1750TA	228	1760S	233	1778BS	240	1838P	245
1720/...	223	1750TLA	228	1760TMC	236	1778CM	240	1838POCKET	244
1720/B	223	1751CR	228	1760WMM	236	1778M7	240	1838RA/10-11LED	245
1720/S	223	1751N	228	1761	236	1778MT	241	1838RB/10LED	245
1720D/...	223	1752	228	1761RS/1	236	1778P	240	1838RB/FLASH	244
1720D/B	224	1754	228	1762	236	1778SCL	240	1838RR/11LED	245
1721/B6	224	1755C	229	1762K	607	1778SOS	240	1838RV/11LED	245
1723	224	1756	229	1763	236	1778V18	240	1838SLIM	245
1725	224	1756B	229	1763G/S500	236	1778X	240	1838SW	246
1725CR	224	1756C	229	1764/K5	236	1781	241	1838UV	246
1725MQ	291	1756C-2OR	229	1764/K5-R	236	1783	241	1839/R1	246
1726	224	1756D	229	1765/C24	237	1783	607	1839/R2	246
1726BM	224	1756D-2OR	229	1766	237	1784	241	1839/R4	246
1727	224	1756E	229	1766/8	237	1784BA	312	1839/R5	246
1727BA	312	1756G	229	1766A	237	1800/100	241	1839/R6	246
1727BM	224	1757	229	1766ER	237	1808	251	1839BRW	246
1728...	224	1757A	229	1766ER/VW	237	1812 150	251	1842	248
1728BA	312	1758	229	1766G	237	1814M	251	1842LED/ABM	247
1729CG	224	1758A	230	1766I	237	1820	251	1842LED/BM	247
1729DM 450	224	1758ADB-45°	230	1766L	237	1820 60	251	1843	248
1730	224	1758ADB-D	229	1766LI	237	1820 80	251	1844	248
1730M	224	1758B	230	1766T	237	1822	251	1844SCK	248
1730V 38	224	1758B/K5	230	1767A	238	1822 180	251	1845	248
1736A	224	1758B-1,6	230	1767B	238	1822 320	251	1846	248
1737	225	1758BA	312	1767PMC	238	1823 60	251	1846R-LED/BM	248
1737AC	225	1758B-RNT	230	1767PMR	238	1823R/60	251	1847	249
1737B	225	1758LG	230	1768	238	1824R	251	1848	249
1737BA	312	1758M	230	1770	238	1825B	251	1850D	325
1737NX	225	1758R	231	1770A	238	1827	251	1850E	325
1738	225	1758RD	230	1770BM	238	1827/K	252	1851VK	325
1739C	225	1758S	230	1770BM	607	1827F	252	1851VK-12C	325
1740AN	225	1758VT	231	1770RL	238	1827PC	251	1851VK-12V	325
1740B	225	1758VT/L	231	1771	238	1827PCL	251	1852 S-PIATTE	249
1741B	225	1759	231	1771BM	238	1827PFL	252	1852R1750	249
1741B/C5	225	1759A	231	1771HD	238	1830T	252	1852S-CC	249
1741BP	226	1759B	231	1771RL	238	1833L	243	1852S-CNT	249
1741RV...K	226	1759HD/3	231	1772H	239	1833L/USB	242	1852S-F	249

ALFANUMERISCHE INDEX

1852S-FLESS	249	1885/C1-R3	258	1916G	348	1930CD	334	1945C/G...	342
1852S-KR/CNT	249	1885/C1-R4	258	1916GF	348	1930HLA	335	1945C/GP...	342
1852S-L	249	1885/C1-R5	258	1916GFE	348	1930LA	335	1945P	342
1860BH R/CM	252	1885/C1-R6	258	1916I	348	1930LH	334	1945P/S...	342
1860BH R/CS	252	1885/C1-R7	258	1916JF	348	1930PA	334	1945S	342
1860BH/120A	252	1885/C1-R8	258	1916JM	348	1930ZL	335	1945S/G...	342
1860BH/160A	252	1885/C2	258	1916P	348	1931AN10	336	1946	343
1860BH/200A	252	1885/C2-R1	258	1916S	348	1931CD10	335	1946C/T...	343
1860BHT R/CM	253	1885/C2-R2	258	1917F	348	1931CD13	336	1946C4,8	343
1860BHT R/CS	253	1885/C2-R3	258	1917JF	348	1931CD6	335	1946C7,8	343
1860BHT/160A	253	1885/C2-R4	258	1917JM	348	1932B10	336	1946KF	343
1860BHT/T	253	1885/C2-R5	258	1917M	348	1932B13	336	1946KF/M...	343
1860DM	253	1885/C2-R6	258	1917RG	348	1932RS13	336	1947	343
1860EI	253	1885/C2-R7	259	1917SP	349	1933	337	1947G	344
1860M	253	1885/C3	259	1917ST	349	1933AN90	337	1947G2	344
1860PMIG	253	1885/C3-R1	259	1918	349	1933AN90-H	337	1947H	343
1860RG	253	1885/C3-R10	259	1918N	349	1933I	337	1948	344
1860SQ	253	1885/C3-R2	259	1918R	349	1933IH	336	1948PR	344
1870	325	1885/C3-R3	259	1919F1/2	350	1933IL	337	1949BC	345
1870-20/5S	326	1885/C3-R4	259	1919F1/4	349	1933ILH	337	1949BC/RUL	345
1870-72 /FC	326	1885/C3-R5	259	1919F3/8	350	1933L	337	1949DGT/2	346
1870-72/FL	326	1885/C3-R6	259	1919FE1/4	349	1934BV	337	1949F2	345
1870I	325	1885/C3-R7	259	1919L	350	1934MAV	338	1949GPA	345
1872L	326	1885/C3-R8	259	1919ML	350	1934MAV70	338	1949GPN	346
1872L 35/5S	326	1885/C3-R9	259	1919RB-F	350	1935F	338	1949M	346
1872L 35/FC	326	1885/XC60	259	1919RB-FE1/4	349	1936/4A	338	1949P	345
1873	326	1889CF	257	1919RF-F	350	1936/5A	338	1949R	346
1873-30/5S	326	1889N	257	1919RF-FE1/4	349	1936/7A	338	1949T	345
1874	326	1893/1234YF	260	1919RM-F	350	1937	339	1949U5	344
1874-50/5S	326	1893/134A	259	1919RM-FE1/4	349	1937C...	339	1949U5/A	344
1874-50/FC	326	1893TR/1234YF	260	1919SC	350	1937K...	339	1949U5/B	344
1875LT	255	1893TR/134A	260	1921B1	330	1937KC	339	1949U5/C	344
1875SP/K3	255	1893TR/CI	260	1921M1	330	1937KL	339	1949U5/D	344
1877	255	1895 13	260	1921M2	330	1937KL-D	339	1949U5/E	345
1877A	255	1895 27	261	1921N3	330	1937M	339	1949U5/F	345
1877F	255	1895 6	260	1922P1	330	1937M-01÷11	339	1949U5/G	345
1877P	255	1895/RC	261	1922P2	330	1937N10	340	1949XS	344
1878 11	256	1895/S	260	1922P3	330	1937N10-GR	340	1950BZK	346
1878 2	255	1895G	260	1924B	331	1937N20	340	1951	346
1878 3	255	1897	261	1924CD	331	1937N20-GR	340	1951A	346
1878 30	256	1897/CRB	261	1924F	330	1937R/P	339	1952	347
1878 4	255	1897/G	261	1924XM	331	1938	340	1956 115-750W	322
1878 8	256	1897/MV	261	1927AN	333	1938R/L	340	1956 125-1400W	323
1879	256	1898/B	261	1927B	331	1938R/S5	340	1956 230-2400W	323
1879 6	256	1898/D	262	1927B/K5	331	1940	340	1966/910W	324
1879/FUEL	256	1898/K40	261	1927CD	332	1940/C6	340	1967/800W	324
1879R/K4	256	1898/M	262	1927CD/K3	332	1940/S5	341	1972/12V-10	315
1880	256	1898/S	262	1927G	333	1940E10	341	1972/20V-13BMC	316
1880ADB	256	1899A	262	1927P	332	1940E10/MT	341	1972/K12V-10	314
1881	256	1899SI	262	1927P/K3	332	1940E10/S...	341	1972/K12V-COMBO	314
1882N	256	1900M 8X15 - 1900M	347	1927SP-AM	333	1940E10/S5	341	1972/K20V-13BMC	316
1883N	256	10X15		1927XM	332	1940MT	341	1982/12V	315
1883NC	257	1900S 8x10	347	1927XM/K5	332	1940S...	341	1982/K12V	314
1884	257	1914	347	1928CD	334	1942A	341	1984 20V/1200BMC	318
1884/C12	257	1915B	347	1928DA	333	1942LR	341	1984 20V/600BMC	317
1884N/C8	257	1915C	347	1928DAL	333	1944A	341	1984/K1200	318
1885	257	1915C/L	347	1928K4	333	1944AR 2	341	1984/K600	317
1885/C1	258	1915D	347	1928P	334	1944N	341	1986/20V-125BMC	319
1885/C1-R1	258	1915E	347	1928XM	333	1944PA	342	1986/K20V-125	319
1885/C1-R2	258	1915E/XL	348	1930A	335	1945C	342	1989RCB	321

ALFANUMERISCHE INDEX

1994B 20V-2AH	320	11204B	577	11491	584	2254T	263	330R/A	28
1994B 20V-4AH	320	11208A	577	11493	584	2258N-O	263	330R/I	28
1994B 20V-6AH	320	11208B	577	11495	584	2258RR	263	331C	28
1994BL 12V-2AH	315	11210A	577	11498	584	2300ST/KIT	370	332	29
1994C 20V	320	11210B	577			2400 RSC24/MP	378	334	29
1994CB 12V	315	11212A	577			2400 RSC24/PC	377	334R	29
1995MQ/G1 - G2	291	11212B	577			2400 RSC24/PD	377	334R/I	29
1995MQ/T	291	11214A	578	2001/B26	352	2400 RSC24/PF	377	336	29
1996MQ/GM	291	11214B	578	2001/BV	352	2400 RSC24/PF-	377	338	29
1996MQ/T	291	11214C	578	2001/BZ24 MQ	353	2400 RSC24/PL	377	338R	29
1996SVG	291	11216A	578	2001/BZ27 VU	353	2400 RSC24/SPC	378	338R/I	29
11001	570	11216B	578	2001/BZV	352	2400 RSC24AXLP/CPR	376	338RP	29
11001H	570	11218A	578	2002/BV12	353	2400 RSC24AXLP/PF	376	339A	29
11003	570	11218B	578	2002/BV13	354	2400 RSC24AXLP/VL	377	339A/R	29
11011	570	11220A	578	2002/BV42	354	2400-COVER RSC24	393	340	29
11011H	570	11220B	578	2002/BV6	9	2400-COVER	393	340C	30
11018	570	11222	579	2002/BV7-ZIP	353	RSC24AXL		340C/KRL	30
11019	571	11230A	579	2002/BV8	353	2499PC	378	340RL	29
11021	571	11230B	579	2002/BV9	353	2499PF	378	341	30
11023	571	11232A	579	2002/BVL6	353	2499PF/M	378	341B	30
11024	571	11234A	579	2005MPU	354			341B/RL	30
11031÷11038	571	11240A	580	2005MPU/E	354			341B/RM	30
11032	571	11240B	580	2005PA/D	354	30	9	341RL	30
11034	571	11242A	580	2005PA/E	354	30BA	304	342	30
11035	571	11242B	580	2005PA/ET	354	31	9	342A	30
11037	571	11246A	580	2005PA/S	354	31/B6N	9	342A/MOL	30
11038	571	11248A	580	2005PA/U	355	31/B6N-LSE	9	342A/RL	30
11040	572	11248B	580	2009N/BV	354	31_serie	9	342MOL	30
11045	572	11259	580	2028/VV	355	31BA	304	342P	30
11046	572	11260	581	2028E	355	31BA/C	304	342P/RL	30
11048	572	11263	581	2029/VV	355	31BM	9	342RL	30
11049	572	11264	581	2029E	355	31BM/D6	9	345	31
11050	572	11265	581	2029EM	355	31L	9	345C	31
11069	572	11266	581	2032/TE	356	31SE	9	345SB	31
11100	573	11268	581	2032/TV	355	32	9	345SB/R	31
11101	573	11271A	581	2033L	356	32AU	9	345SB2	31
11102	573	11271B	581	2033L/VV	356	32AUR	10	345SC	31
11105	573	11271C	581	2036/TV	356	32BA	304	345SI	31
11106	573	11276A	581	2036E	356	33LT	10	345SI/R	31
11107	574	11276B	581	2037/TV	356	33NR	10	345U	31
11110	574	11276C	581	2038/TV	356	34	10	345U/A	31
11111	574	11300A	582	2041UC	357	34BA	304	349	31
11115	574	11300B	582	2051N	357	35	10	349/SMAS	31
11116	574	11300C	582	2055HB	357	35PM	10	349/SMM	31
11120	574	11300D	582	2080/D10	357	35PMR	10	350	32
11121	575	11300E	582	2080/V12	357	36	10	351C	32
11125	575	11300F	582	2080/V12-...	357	37	10	351P	32
11130	575	11300G	582	2080/V6	357	37PM	10	352C/U	32
11131	575	11320	582	2080/V6-U	357	37PMR	10	352U	32
11132	575	11411	582	2080/VG	262	38/DS1	611	355	32
11135	575	11415B	582	2109MT ID/1	360	38/DS2	611	357F3	32
11140	576	11420B	583	2115P L-MQ32	362	38_serie	10	357R/F3	32
11141	576	11431	583	2115PI/BIKE-HOME	361	39BA	305	358	32
11145	576	11440A	583	2250-O	262	310	27	358RL	32
11200A	576	11440B	583	2252	262	310/C8	28	359	32
11200B	576	11440C	583	2252KR4	262	310B	27	359CH	33
11202A	576	11450A	583	2254A	263	311	28	360	33
11202B	576	11450B	583	2254C	263	330	28	360R/...	33
11202C	576	11450C	583	2254F	263	330BA	307	361N	33
11204A	577	11488PF	584	2254K	263	330BA/2R	307	362	33
				2254SM	263				

362R/...	33	3010/T...	266	3040C/S2	274	3500/P-M	385	4		
363	33	3010H	266	3041C	274	3700/PC	388			
363BA	307	3010V	266	3041C/12	274	3700/PF	388		42	11
363R/...	33	3011/T	266	3041C/16	275	3700/PFL	388		42/B	10
365	33	3012	267	3042C	275	3700/PLA	388		42/B9N	11
365R/...	33	3012C	267	3043C	275	3700/PLL	388		42/S	12
366	33	3012I	267	3043C/ 41÷47	275	3700-COVER C37	393		42/SC9I-E	12
374	33	3014	267	3047C	275	3910	281		42/SP_plastica	12
374K	597	3014 SAR	267	3048C	275	3912PP	281		42/SP25	12
374R/...	34	3014R/GR5	267	3050/600	275	3912TP	281		42AS	12
375	33	3014SAR/1	267	3050/CC	275	3912TP/A	281	42AS/B9N	12	
376	33	3014SAR/2	267	3050/KA	275	3912TP/C	281	42AS/S	12	
378	34	3014SAR/RR	267	3050/LA	276	3912TP/FOX	281	42BA	305	
378BA	307	3023	267	3050/MS	275	3912TP/QRE	281	42BA-AS	305	
383	34	3025N	267	3050/MV	276	3912TP/ROAD	281	42LMP	13	
383R	34	3025N/PF	268	3054	276	3912TP/RS	281	42LMP/S	13	
384	34	3026 0,3	268	3055M	276	3912TP/ST	281	42MP	12	
384RC	34	3026 0,5	268	3057	276	3916MMP	282	42MP/B9N	12	
386A	34	3026 1,0	268	3061/2T	272	3918MML	282	42MP/S	12	
386A/RC	34	3026/R 1,0	268	3061/2T-P100	272	3921	282	42NEWK	596	
386BA	307	3026/R0,3	268	3061/2T-P50	272	3923	282	42SLIM	13	
387	34	3026/R0,5	268	3065/20-10T	273	3927	282	42SLIM/B8NI-E	13	
387R	34	3026/S	268	3065/40-20T	273	3932U	282	42SLIM/S11	13	
388	34	3026/SA	268	3067/60-15T	273	3935	282	45	13	
388A	34	3026/SAM	268	3067/70-13T	273	3937	282	410	36	
388C/C8	35	3026/SP	268	3068	273	3948	282	410/SEL	37	
389/K4	35	3027/PR	270	3069	273	3952	282	410/SP	36	
392C	35	3027N 10	269	3070B	276	3952/S	282	410A	37	
392RG/C	35	3027N 100	269	3070B/10	276	3953	282	410AS	37	
393	35	3027N 20	269	3070BE/B	277	3955	282	410AS/SEL	37	
395	35	3027N 30	269	3070BE/F	277	3961 3,2	282	410AS/SP	37	
395T	35	3027N 50	269	3070BE/K	276	3961 3,3	283	410MIX/SEL19	37	
398	35	3027N/KP	269	3070BE/S	276	3961 3,5	283	412	37	
399	35	3027N/KPP	269	3071A	277	3961U	283	412/C150	38	
399R/...	35	3028 15	270	3071B	277	3962MV	283	412/SP	37	
3000L	263	3028 20	270	3071RS	277	3962SH	283	412/SP91	38	
3000L/RLS	263	3028 30	270	3072N	277	3963P	283	412A	38	
3000M/PLM	383	3028 50	270	3073	277	3964	283	412L	38	
3002	264	3028/KP	270	30740	277	3965	283	412XL	38	
3002/RLS	264	3028SP/15	270	30740/2	278	3965C	283	414	38	
3003	264	3028SP/20	270	30740/M	278	3967	283	414/C116	39	
3003/RLS	264	3028SP/30	270	30740/S	278	3969	283	414/SP	38	
3003C	264	3028SP/50	270	3075/CM	278	3969K3	283	415	39	
3003C/RLS	264	3029/2T	271	3075/K10	278	3971	283	415/C116	39	
3003PRO	264	3029/2T-L/R5	271	3075A	278	3972	283	415/SP	39	
3003PRO/PM	264	3029/2T-L/R6	271	3075B 55	278	3973/1	283	415/SP91	39	
3003PRO/RRCR	264	3029/2T-L/RP	271	3075MV	278	3973/2	284	415CO	39	
3003PRO/RRG	265	3029L/2T	271	3079/21	278	3973/3	284	415CO/SP	39	
3003PRO/RT	265	3030/2T	271	3080/C15	278	3973/4	284	415CO-A	39	
3003PRO/SP	264	3030/2T-R5	271	3080R/CS3	278	3973PF	283	415L	40	
3004	265	3030/2T-R6	271	3081	278	3975	284	416	40	
3006	265	3030/2TRP	271	3085	278	3984/1	284	416/SP19	40	
3006 R/RG	265	3030H/2T	271	3091	279	3984/2	284	416P/SP19	40	
3006 R/RGF	265	3033/3T	271	3092	279	3984/3	284	417	40	
3007	265	3033E/3T	272	3093/E	279	3984/4	284	417/SP	40	
3007 R/RG	266	3033S 3T/R2	272	3093/U	279	3984/5	284	419	40	
3007 R/RGF	266	3035	272	3094PA	279	3984/6	284	419/SP	40	
3008N	266	3036	272	3095	279	3991	284	419T	41	
3009	266	3040C	274	3099E	279	3992	284	421	41	
3009R/GR4	266	3040C/S1	274	3099T	279					

ALFANUMERISCHE INDEX

421/SP6	41	437K/12	47	53	13	5904VI/2T	482	605E	62	
422	41	437K/16	47	55	13	5904VI/3T	483	606_RIC	63	
423	41	437K/33	47	55/B12N	14	5904VU/1M	490	606MQ/50	287	
423A	41	437K/8	46	55/B8N	14	5904VU/2M	491	610/5	62	
424	41	437K/9	46	55/S	14	5904VU/2T	492	610L/5	62	
424/SP	41	437P	46	55/SP	14	5904VU/3T	493	610L/5L	62	
425	41	437U/09	47	55AS	14	5904VU/4T	494	611	62	
425/SP	41	437U/E-M...	47	55AS/S	14	5905VG/1	525	612 ÷ 614	62	
426	42	437U/PM	47	55BA	305	5905VG/2	526	614/50	63	
426/SP	42	438...	47	55BA-AS	305	5908VG/2T	527	615	63	
426A/SP6	42	438A	47	55K	596	5908VI/2T	484	616 - 617 - 619	63	
426MD/CP	43	440	47	55MP	14	5908VU/2T	495	621	63	
426MD/CT	43	440A	47	55MP/S	14	5910VI/3	485	622	63	
426MD/F	43	440ASC	48	58	14	5910VI/3T	486	641	63	
426MD/FA	43	440ASF	48	58BA	305	5914VU/M	496	642	63	
426MD/OG	43	440ASG	48	58BA-AS	305	5915VU/0	498	643	63	
426MD/OV	43	440ASW	48	560/C12	55	5915VU/1	498	644	63	
426MD/S	43	440B	48	560/C2	55	5915VU/2	499	650A	64	
426MD/SP10	43	441	48	560/C3	55	5915VU/3	499	650H	64	
426MD/T	43	441A	48	560/C3PLUS	55	5915VU/4	500	652	64	
426MD/TA	43	441B	48	560/C4+	55	5915VU/5	500	653	64	
426MD-3/A9	43	442	49	560/C6	55	5915VU/AS	501	654	64	
426MD-3/CP3	42	443	49	561/1	55	5927VU/M	501	659/15	64	
426MD-3/CT3	42	444	49	562-1/VA - 562-2/VA	56	5935ET/1MB	511	659/16	64	
426MD-3/F3	42	444G	49	562VV-A	56	5935VG/1MB	528	665	64	
426MD-3/FA3	42	446/C110	50	564-3R/V - 564-4R/V	56	5935VI/2MB	487	665LB	65	
426MD-3/OG3	42	446/C30	49	565-1R/VA - 565-2R/ VA - 565-3R/VA	56	5938U/2T	502	665SW	65	
426MD-3/OV3	43	446/C48	49	565-4R/VB	56	5940SBK	528	666	66	
426MD-3/S3	43	446ASC/C37	50	565-5R/VB	56	5941VU/M	529	666 LBF.FT	66	
426MD-3/T3	43	446ASF/C29	50	565VV-B	56	5945VUM_2024	530	667	66	
426MD-3/TA3	43	446ASG/C23	50	567-4R/VB	56	5954VG	531	668N	66	
426SB	42	446ASW/C36	50	567-5R/VB	56	5954VI	489	668RG	67	
426SB/SP	42	447/C37	51	581	60	5957U-P	503	668RGC	67	
426T	42	447/C53	51	583	60	5957VG	532	669N	67	
426T/SP	42	447/C70	51	583/C31	60	5957VI	488	671B/C10	67	
427	44	450	51	590 - 592	60	5958U	504	671B/C5	67	
428/C14	44	450/C13	52	594	60	5980/MQ	513	671N/C10	67	
428FC	44	450/C15	52	596 - 598	60	5980EL/A	514	671N/C20	68	
428FP	44	450/C21	52	599DGT	61	5980EL/B	515	671N/C30	68	
429/C14	44	450/C9	52	599DGT-AN	61	5980ET/A	512	674/C	68	
429FC	44	450AD	51	5000 RSC50/ASL	475	5980ET/B	513	677	68	
429FP	44	450AL	51	5000 RSC50/CAL	453	5980ID/1	516	677/C	68	
430	44	450PA/1	52	5000 RSC50/CLL	453	5980U/BIKE	506	677/CP2000	68	
430/SP	44	450PA/2	52	5000 RSC50/CTR	476	5980U/BIKE-M	507	677/CV - 678/CV	69	
430ASC	45	450PR	52	5000 RSC50/KFC	453	5988 VHB-MQ	514	678/C	69	
430ASW	45	451	52	5000 RSC50/MP	453	5988H/7M	508	680	69	
431	45	451/C	53	5000 RSC50/MPA140	453	5988L/4M	509	682	69	
431/SP	45	451GA	53	5000 RSC50/PLED	475	5988U/7M	497	6200AP/S10	670	
433	45	451PA	53	5000 RSC50/PLED-ST	475	5988U6/M	510	6600 M/112	618	
433ASF	45	451PR	53	5700LAMP	405	5989 VEM	517	6600 M/116	618	
433ASG	45	452	53	5902MT	518	5990V1	505	6600 M/120	618	
434	45	452GA	53	5902MT/AS	519	5990V3	505	6600 M/125	618	
435	46	460	53	5902VI	481	6				
435G	46	460G	53	5904VG/2M	520					
436	46	460PP	53	5904VG/2T	521	600	61	6600 M/14	616	
436L	46	4900-COVER C49	397	5904VG/3	522	601C	61	6600 M/174	618	
436R	46	5			5904VG/3T	523	601CA	61	6600 M/175	618
437C	46				5904VG/5T	524	603	62	6600 M/217	618
437C/...	46	52	13	5904VI/1T	481	604B	62	6600 M/218	618	
437C/RM14	46	52MQ	286			605DGT/2	62	6600 M/22	616	

ALFANUMERISCHE INDEX

6600 M/222	618	6600 M/881	622	720RNG	72	7042LCD/RV	254	7352B	642
6600 M/223	618	6800 VE	616	720S	71	7042LCD/RV-INT	254	7352G	642
6600 M/230	619	6800BA	670	720S/SB6	71	7043	254	7352LG	643
6600 M/236	619	6800RS	670	720TC	72	7061TC	669	7353Y	643
6600 M/241	619	6888	616	720TC/S5	73	7076BC	669	7354N	643
6600 M/242	619	6888B1/2	609	720TX	73	7076BD	669	7355V	643
6600 M/253	619	6888B1/4	609	720TX/C6	73	7076BP	669	7356G	644
6600 M/27	616	6888B3/8	609	720XZN	73	7076BU	669	7356LN	644
6600 M/29	616	6888GS	670	720XZN/C6	73	7093BC	669	7356V	644
6600 M/311	619	6888GW	670	727/C16	75	7093BD	669	7357G	644
6600 M/315	619	7		727/ES16	74	7104 90	668	7357V	645
6600 M/320	619	7		727/ES16TX	74	7105 6	668	7362B	645
6600 M/326	619	73	15	727/ES16XZN	74	7109A	668	7363N	645
6600 M/327	619	73/B13N	15	727/ES22	75	7109D	668	7371V	645
6600 M/33	616	73/S	15	727/ES22TX	75	7201BKK	637	7372B	646
6600 M/330	619	78	15	727/ES32	75	7210BKK	637	7376A	646
6600 M/371	619	78AS	15	727PI/16	74	7212B	634	7381N	646
6600 M/380	620	78BA	305	727PI/16 1/2	74	7212G	635	7382N	646
6600 M/40	617	78BA-AS	306	727PI/22	75	7213G	635	7398 0/G	648
6600 M/406	620	710	70	727PI/32	75	7214FN	635	7398EF	649
6600 M/417	620	710/16	70	728	75	7214G	636	7398ESD	648
6600 M/42	617	710/20	70	728/15	76	7215FN	636	7398GEL	648
6600 M/423	620	710/21	70	728/16	76	7216BKK	637	7398T	648
6600 M/424	620	710/22	70	728/21	76	7218FN	636	7398U	648
6600 M/427	620	710/25	70	728/22	76	7218G	636	7398UP	648
6600 M/430	620	710/C10	70	728/22L	76	7220PEK	633	7399 A/N...	649
6600 M/44	617	710/OR... - 710/SP...	70	728/25	77	7221PEK	633	7421	649
6600 M/440	620	720	70	728/C10	75	7222PEK	633	7422P	649
6600 M/456	620	720/15	73	728/OR - 728/SP	77	7223PEK	634	7425	649
6600 M/465	620	720/16	73	728AS	76	7236BK	638	7426P	649
6600 M/47	617	720/20	74	728B	75	7238WR	638	7427	649
6600 M/480	620	720/21	74	728B/C10	75	7241BK	630	7430T	649
6600 M/485	620	720/22	74	728FTX	76	7241CK	630	7431P	649
6600 M/51	617	720/25	74	728L	76	7241EN	629	7527	652
6600 M/510	621	720/C12	70	728L/S	76	7243BK	630	7528	652
6600 M/52	617	720/C24	71	728LQ	76	7243CK	631	7529	657
6600 M/532	621	720/C6	70	728LS	76	7243CR	631	7530	652
6600 M/534	621	720/OR... - 720/SP...	74	728ME	76	7243EN	629	7545F	664
6600 M/542	621	720/SN	73	728ME/C6	76	7243FT	631	7547AZ	664
6600 M/548	621	720AS	71	729	77	7245BK	631	7547BL	665
6600 M/561	621	720B	71	729/15	64	7246BK	632	7547G	665
6600 M/58	617	720B/C12	71	729/16	77	7246E	629	7547N	665
6600 M/583	621	720FRD	72	729/21	77	7247BK	632	7547R	665
6600 M/59	617	720FTX	73	729/21L	77	7249GK	638	7548C	665
6600 M/61	617	720FTX/SB	73	729/22	77	7293HM	647	7548M	665
6600 M/62	617	720IC	72	729/25	77	7294HM	647	7549AZ	665
6600 M/63	617	720L	71	729/OR... - 729/SP...	77	7294HMC	647	7549BL	665
6600 M/643	621	720L/S3	71	729L	77	7314AF	639	7549G	665
6600 M/650	621	720LC	72	729LS	77	7315AN	639	7549N	666
6600 M/657	621	720LC/C3	72	729T	77	7316NB	639	7549NE	666
6600 M/658	621	720LC/PM5	72	730	78	7316NG	640	7549R	666
6600 M/716	622	720LC/S5	72	730/15	78	7317NA	640	7550G	666
6600 M/73	617	720LCL	72	730/21	78	7318AN	640	7550N	666
6600 M/813	622	720LCL/C3	72	730/25	78	7320NA	640	7557BL	666
6600 M/842	622	720LS	72	730L	78	7321NA	641	7575N	661
6600 M/852	622	720MC	71	733/15	78	7322SA	641	7579QN	661
6600 M/856	622	720MC/C13	71	7041LCD/4S	254	7323SA	641	7600G	652
6600 M/857	622	720ME	73	7041LCD/4S-VE	254	7328A	632	7600N	652
6600 M/871	622	720ME/C8	73	7041LCD/4S-VI	254	7328N	632	7610G	653
6600 M/878	622	720MRC	72	7042LCD	254	7352A	642	7610N	653

ALFANUMERISCHE INDEX

7611G	657	7907G	662	861PE	81	8002ZS	676	8040EN-K	684
7636N	663	7909B	660	861PH	80	8003ZD	676	8040EZ	684
7637G	663	7909G	660	861PH/C	80	8003ZS	676	8040EZ	684
7642G	663	7909P	660	861PZ	80	8004ND	676	8040EZ-K	684
7650	653	7909V	660	861PZ/C	81	8004NS	676	8041	683
7650B	653	7930MG	656	861RIBE	81	8005TZ	673	8041-K	683
7653G	660	7931MG	658	861RTX	81	8005TZ-K	673	8042EN	685
7654B	663	7935MG	659	861SP	81	8005Z	673	8042EN-K	685
7654N	664	7937MG	662	861TQS	81	8005Z	673	8042EZ	685
7657B	664	7940	656	861TRW	81	8005Z-K	673	8042EZ	685
7657N	664	7949	661	861TX	81	8006Z	673	8042EZ-K	685
7658CM	662	7970	666	861TX/C	81	8006Z	673	8043	684
7659N	662	7971L	667	861XZN	81	8006Z-K	673	8043-K	684
7660B	653	7978L	667	862F	83	8007Z	674	8044	685
7660G	653	7979	667	862F/A7	83	8007Z-K	674	8048	677
7661B	657	7980L	668	862LP	82	8008N	674	8049	682
7661G	657	7980NC	668	862PE	82	8008N-K	674	8049A	683
7664G	664	7980RN	668	862PH	82	8008TZN	674	8049V	683
7664N	664	7981N	668	862PH/L	82	8009FD	677	8050 D	697
7665G	664	7982N	668	862PH-XL	82	8009FS	677	8051S	692
7665N	664	7984EG	668	862PZ	82	8009TZ	674	8051S-K	692
7669N	662	7984G	668	862TX	82	8009TZ-K	674	8052 - 8055S	691
7670G	662	7985N	668	862TX/L	82	8009Z	674	8057R - 8057	691
7673NG	661	7996N	667	862TX-XL	82	8009Z	674	8058R - 8058	690
7674NG	663			862XP/A16	83	8009Z-K	674	8058R/PS	698
7750N	663	8		866LP	83	8010TZ	675	8060R - 8060	690
7780QN	663	80	15	866PE	83	8010Z	675	8060R/PS	698
7800G	668	80/S	15	866PH	83	8010Z-K	675	8061R - 8061F	691
7815CM	657	83	15	866PZ	83	8011TZ	675	8062	692
7818BL	654	83/S	15	866RTX	83	8011Z	675	8063	691
7818CM	654	83AS	16	866TX	83	8015	678	8063SL	691
7818G	654	83AS/S	16	867/...	84	8016	678	8064S	691
7818LN	654	88	16	867/C20	84	8016	678	8065SC	692
7819G	654	88/S7	16	867/C38	84	8016FR	679	8068S	683
7830SN	654	89BA	306	867/C52	85	8016-K	678	8074	695
7830ST	655	89MQ	286	867PE	83	8016U2	679	8074	695
7831SN	657	850MQ	287	867PE/L	83	8016UGK	679	8074A	695
7831ST	657	851	78	867RIBE	84	8016U-K	679	8074G	695
7840BL	655	851SR	78	867RIBE/L	84	8018E	679	8080	695
7849BL	660	852	79	867RTX	84	8018T	679	8080FM	695
7850G	655	855P	79	867RTX/L	84	8020	680	8082	695
7860B	655	855P	598	867TX	84	8020A	680	8083	696
7860G	655	860/55	79	867TX/L	84	8021A	680	8085R	690
7861B	658	860/58	79	867XZN	84	8025	681	8086	690
7861G	658	860/58K	598	867XZN/L	84	8025	681	8090F	710
7863G	658	860/C27	79	882	85	8025-K	681	8090R - 8090	690
7865B	659	860/C38P	80	882AN	85	8026A	682	8091	686
7865G	659	860LP	79	882M	85	8026A-K	682	8091SL	686
7867B	661	860MIX/A10	80	882M1	85	8026R	680	8092	686
7867G	661	860MIX/A31	80	882MSR	85	8026R-K	680	8092SL	687
7869G	660	860PE	79	882P	85	8028	682	8094	687
7880SC	655	860PE/A10	80	892	85	8028-K	682	8094SL	687
7900B	656	860PH	79	895	85	8029R	680	8096	688
7900G	656	860PHZ/A10	79	897	85	8029R	681	8096SL	688
7900P	656	860PZ	79	897L	85	8029R-K	681	8097	688
7900V	656	860RTX	79	8001TZ	675	8031R	681	8097SL	689
7901G	658	860TX	79	8001TZ-K	675	8031R-K	681	8098	689
7903G	659	860TX/A10	80	8001Z	675	8032	681	8098SL	689
7903P	659	861/C61P	82	8001Z-K	675	8032-K	681	8100	690
7905G	659	861LP	80	8002ZD	676	8040EN	684	8105	672

ALFANUMERISCHE INDEX

8105-K	672	8180	710	8274	703	8889P3	559	96C/AS	19
8109	672	8181	710	8274	703	8889P4	559	96C/AS	596
8109-K	672	8181 6/S4	710	8274A	703	8889PD	560	96C-AS/SC9	19
8110	672	8181S	710	8274G	703	8889PS	560	96L	20
8114	696	8182	711	8276	703	9		96L/SC12	20
8116	696	8182 8,5/S2	711	8276G	704				96L/SP8
8120	694	8182A	711	8278	704	90	16	96LBP	20
8120B	694	8182E	710	8279	706	90/B8N	16	96LBP/SC9	20
8120D	694	8182GD	711	8280	704	90/S	16	96LBP/SC9	597
8120DZC	694	8182H	711	8282S	705	90/SP	16	96LC	19
8121MZC	694	8182H/2	711	8284	705	90AS	16	96LC/SC12	20
8129	695	8182S	711	8285	705	90AS/S	16	96LC/SC8	20
8130	695	8182T	710	8286	705	90BA	306	96N	18
8134	692	8182TS	710	8287	705	90K	596	96N/B	19
8135	692	8183	711	8290	705	91	17	96N/G	19
8135/KLA1	698	8184	711	8293	706	91BA	306	96N/SC12	19
8135/KMO	698	8185	712	8297C	706	92	17	96N/SC9	19
8143	692	8186	712	8297F	706	92BA	306	96N/ST	19
8143/RKCI	698	8187	712	8302Z	677	93	17	96N/ST6K	596
8143/RKL	698	8188/K8	713	8302Z	677	93BA	306	96T	21
8143/RPC	698	8188C	712	8303Z	677	93C	17	96T/AS	21
8143/RPF	698	8188CG/25	712	8303Z	677	93K	596	96T/S11	21
8146	693	8188CU/25	713	8317DZ	696	94	17	96T/S6	21
8146/RK	698	8188F	713	8317SZ	696	94/S	17	96T/SP	21
8146/RKCI	699	8188F35	713	8381SL	696	94K	596	96T/SPV	561
8146/RKFC	698	8188VFG2	713	8381SP	696	95	17	96TAS/S	21
8146/RKL	698	8189	713	8381SX	706	95/S	17	96TBP	22
8146/RPC	698	8189A	713	8383C	697	95BA	306	96TBP/S6	22
8146C	693	8189PA	713	8383P	697	95FTX	17	96TK	597
8147C	693	8190	712	8515CH	697	95FTX/S	17	97BRTL/SC8	23
8147P	693	8190B	712	8515V	697	96	18	97BTX	22
8147S	693	8201T	701	8515Z	697	96/B	18	97BTX/B	22
8148	694	8205	700	8531	697	96/BG7	18	97BTX/SC8	22
8148/RA	699	8205	700	8532	697	96/BGS7	18	97BTX-C	22
8148/RKCL	699	8206	700	8535	697	96/SC12	18	97BTX-C/SC8	22
8148/RKCM	699	8207	700	8600 R/11	622	96/SC9	18	97BTL	23
8148/RKG	699	8209	700	8600 R/113	623	96/ST	18	97BTL/SC8	23
8148/RKS	699	8210	700	8600 R/114	623	96/ST6K	596	97RTX	23
8148/RP	699	8210F	701	8600 R/12	622	96AS	19	97RTX/B	23
8148F	694	8210FTP	701	8600 R/13	623	96AS/B	19	97RTX/SC8	23
8149	699	8216	701	8600 R/225	623	96AS/BG7	19	97TTX	23
8149CM	699	8216	701	8600 R/412	623	96AS/SC9	19	97TTX/S	23
8149CM/RA	699	8216-K	701	8600 R/511	623	96AS/T	19	97TTX/SP	23
8150	706	8220	702	8600 R/601	623	96BA	306	97TX	22
8153	707	8225	702	8600 R/611	623	96BA/BP	306	97TX/B	22
8156	707	8225	702	8702N	677	96BAF-AS	307	97TX/BG8	22
8157	707	8227	702	8702Z	677	96BP	20	97TX/G	22
8158	707	8228	702	8702ZC	677	96BP/AS	21	97TX/SC8	22
8159	707	8240	702	8709N	678	96BP/ASB	21	97TX/ST	22
8160	707	8240F	702	8709Z	678	96BP/AS-SC9	21	98XZN	23
8161	708	8242	703	8709ZC	678	96BP/SC9	20	98XZN/B	23
8166	710	8242F	703	8889C1	559	96BPA	21	99	23
8170	708	8248	701	8889C2	559	96BPA/SC9	21	99 VN/...	24
8173	708	8249	701	8889C3	559	96BPA/SC9	596	99BA	307
8176	708	8249G	701	8889C6	560	96BPC	20	99SQ	24
8177	708	8250	704	8889CD	560	96BPC/SC9	20	99ST	24
8178	708	8264	704	8889CS	560	96BPC/SC9	596	900	86
8179A	709	8267	704	8889I4	559	96BP-CL	20	900/...	89
8179B	709	8272	705	8889P1	559	96BP-CL/SC9	20	900/16	88
8179M	709	8273	705	8889P2	559	96BP-CL/SC9	596	900/20LK	598

ALFANUMERISCHE INDEX

900/25	89	900PE/AS	88	910BL/SB	94	920/55	104	920ES/SB	103
900/25K	599	900PH	88	910BP	96	920/55K	599	920ES/XL-SB	103
900/32	89	900PH/SB4	88	910BP/SB6L	96	920/55LC	105	920FTX	101
900/35A	89	900PT	88	910CF	96	920/55Q	104	920FTX/C	101
900/40	89	900PZ	88	910CF/SB	96	920/55X	105	920FTX/L	101
900/42	89	900T/44	89	910FTX	95	920/56A	105	920FTX/LSB	101
900/55	89	900TX	88	910FTX/L	95	920/58	105	920FTX/SB	101
900/55K	599	900TX/SB	88	910FTX/LSB	95	920/58K	599	920LH/SB7	101
900/55Z	90	900U	87	910FTX/SB	95	920/C37	107	920LP	101
900/55ZK	599	900U/C12M	92	910FTX/XL	95	920/R50	111	920M/35	104
900/58	90	900U/SB	87	910FTX-XL/C10	95	920/R55	111	920M/35L	104
900/58K	599	902A/C22	93	910LP	95	920/R55LC	112	920M/55	105
900/C11	90	902R/C6	93	910M/35	97	920/R55Q	111	920M/56	105
900/C11HR	93	910/15	96	910M/35L_WARN	104	920/R55X	112	920M/R55	111
900/C11Z	91	910/16	97	910M/55	97	920A	99	920MC	100
900/C12MR	91	910/20 - 910/21 - 910/22	97	910M/56	98	920A/AS	100	920MC/C14	106
900/C12MZ	91	910/21K	599	910M/R55	111	920A/C11	105	920ME	102
900/C13-5	91	910/25	97	910ME	96	920A/C12	105	920ME/C	102
900/C13-8	91	910/25K	599	910ME/SB	96	920A/C12X	105	920ME/SB	102
900/C24	92	910/36A	97	910MQ/21	287	920A/C17HR	108	920MQ/21	288
900/C39N	90	910/40	97	910MQ/22	287	920A/C17M	107	920MQ/22	288
900/C39U	90	910/42	97	910MQ/55	287	920A/C17MR	107	920MQ/55A	288
900/R55	111	910/46	97	910MQ/B	287	920A/C20	106	920MQ/A	288
900/R55-Z	111	910/55	97	910MQ/C16	287	920A/C20Q	106	920MQ/C16	288
900/SB	86	910/55K	599	910MQ/PE	287	920A/C20X	106	920MQ/PE	288
900AN	89	910/55Q	97	910MQ/PT	287	920A/C21	106	920MQ/T	288
900AS	87	910/58	98	910MQ/T	287	920A/C21X	106	920PE	102
900AS/C10	93	910/58K	599	910MQ/TX	287	920A/C33	107	920PE/AS	102
900AS/C17-MBM	93	910/R55	111	910MQ/XZN	287	920A/SB13	99	920PE/C	102
900AS/L	87	910/R55Q	111	910PE	96	920A/SB8	99	920PE/SB	102
900AS/MB	87	910/R55X	111	910PE/AS	96	920A-AS/SB11	100	920PE-AS/SB6	102
900AS/MB-C17	93	910A	93	910PE/SB	96	920AK	599	920PH	101
900AS/MBL	87	910A/AS	94	910PH	95	920AL	100	920PH/SB4	101
900AS/SB11	87	910A/C10	98	910PH/SB4	95	920AL/SB11	100	920RTX	103
900BG/30	89	910A/C16	98	910PT	96	920AN	103	920RTX/SB	103
900BG/30C	89	910A/C16HR	99	910PT/SB	96	920AS	100	920TX	102
900BG/30K	599	910A/C16Q	98	910TX	96	920AS/C10	108	920TX/C	102
900FL	89	910A/C17	98	910TX/SB	96	920AS/C15	108	920TX/C17	108
900FTX	87	910A/C29	99	910XZN	96	920AS/C17X	108	920TX/L-SB4	102
900FTX/SB9	87	910A/SB	93	911BA	307	920AS/L	101	920TX/SB	102
900K	598	910A-AS/SB13	94	911BA/16	307	920AS/MBM-C21	108	920U	101
900L	86	910AK	599	911BA/20	307	920AS/SB11	100	920U/C17M	109
900L/SB	86	910AL	94	911BA/55	307	920ASL/SB11	101	920U/SB13	101
900LP	87	910AL/SB14	94	914MQ/A	288	920B	100	920U/SB4	101
900M/35	89	910AN	97	914MQ-A/S4	288	920B/C11	105	920XZN	103
900M/55	90	910AS	94	920/15	103	920B/C12	106	920XZN/LS	103
900M/R55	111	910AS/C13	99	920/16	103	920B/C12X	106	920XZN/SB12	103
900MB	86	910AS/L	95	920/20÷920/23	103	920B/C20	106	920XZN/SB7	103
900MB/C19	91	910AS/MBM-C18	99	920/21K	599	920B/C20X	106	921BA	308
900MB/C28	92	910AS/SB13	94	920/25	104	920B/C21	106	921BA/15	308
900MB/L	87	910AS/SB13	94	920/25K	599	920B/C21X	107	921BA/16	308
900MB/SB	86	910AS/SN	95	920/35A	104	920B/C30Q	107	921BA/21 - 921BA/22	308
900MC	86	910ASL/SB12	95	920/36A	104	920B/C33	107	921BA/25	308
900MC/C24	92	910B	94	920/38	104	920B/SB13	100	921BA/42	308
900MC/C32	92	910B/C10	98	920/40	104	920B/SB8	100	921BA/50	308
900MC/LP	87	910B/C16	98	920/42	104	920BL	100	921BA/R50	308
900MC/PH	88	910B/C16Q	98	920/44	104	920BL/SB11	100	921BA-AS	308
900MC/TX	88	910B/C29	99	920/46	104	920BP	102	926BA	308
900ME	88	910B/SB	94	920/50	104	920BP/SB	102	926BA/15	308
900ME/SB8	88	910B/SN	94	920/50F	104	920ES	103	926BA/22	308
		910BL	94						

ALFANUMERISCHE INDEX

926BA/42	308	944BX/S	114	960RPI	122	993G	126	9548KB	721
926BA/50	309	949	114	960SL	119	993MQ	289	9548KB 20	721
926BA/R50	309	949/S6	114	960SN	119	993PL	126	9548KB 24	721
928.../C12	110	950	114	960T/A	120	994	126	9549ABW	723
928/15	109	950/S	114	960T/B	120	994MQ	289	9549BP	723
928/16	109	951	115	960T/C	120	994PL	126	9549BRW	724
928/20 - 928/21 - 928/22	109	951/S	115	960T/C11	120	994TF	126	9549C	724
		951/SP	115	960T/F	120	996	126	9549CR	723
928/25	109	951AS	115	960T/G	120	998	126	9549MPC	723
928/36A	110	951AS/S	115	960T/H	120	999	126	9549SBW	723
928/42	110	951BA	309	960UC	121	999/B6N	127	9557J 2.0	717
928/55	110	951GP	115	960VTC	122	999A	126	9557N	717
928/R55	112	951GP/S6	115	960YP	121	999B	126	9559	722
928/R55X	112	951K	600	961BA	309	999C	126	9559/30MT	722
928A	109	951MQ	288	961P6	122	999D	127	9561V	722
928AS	109	951TX	116	961P6/S	122	999E	127	9561V 2,5	722
928AS/C12	110	951TX/S	116	962	122	999G	127	9561VV	722
928B	109	952	116	962C	122	9500TL	715	9561VV 2,5	722
928B/C12	110	952/D7	116	962M	123	9501TL	715	9562P12	726
928ME	109	952/S	116	962P	123	9501TLD	715	9562P2	726
929	110	952AS	117	963	123	9502TL	716	9562T1	276
929/15	110	952FTX	117	963BA	309	9503TL	716	9562T2	409
929/21 - 929/22	110	952FTX/S	117	964	123	9504TL	716	9562T3	276
929/42	110	952L	117	964BA	309	9505TL	716	9562TB	670
929/55	110	953	117	964BA/L	309	9510W	716	9563G	723
929/55PR	111	953/S	117	965	123	9520P	718	9563U	723
929/C8	111	953TX	117	965/S	123	9521	718	9565K	723
929/R55	112	953TX/S	117	965BA	309	9521OB	719	9565S	670
930	112	955	118	966/C3	123	9522A	724	9565T	723
930/C	112	956C	118	966BA	309	9523A	724	9569MS	725
930/S	112	956E	118	966BA/V	309	9523T	721	9569MS-2	725
932	112	956F	118	969/C5	123	9524SC	721	9569P	725
932/S	112	956L	118	969B	123	9525CM	718	9569S	725
933	112	957	118	970B	123	9525TR	718	9572LB	716
933/S	112	959	119	970IVECO	123	9525WB	718	9574B	718
935	113	959R	119	971/C8	124	9526F	719	9574O	718
935/S	113	960	119	972/C10	124	9526P	724	9577R	722
935K	599	960/22EP	120	972/C4BMW	124	9526RMN	724	9579C	722
937	113	960/C6	120	973	124	9527 6T	724	9580S	717
937/S	113	960/D	120	978 - 979	124	9528B	721	9586K	724
937BA	309	960A	119	982	124	9534BO	716	9587 13x21	725
937K	599	960AD/TP2	175	983 PM/R-DA	124	9534WO	716	9587 9x14	725
940	113	960AVE	121	983PM	124	9537TL	716	9588/10PI	725
941	113	960BC/C5	119	984	124	9539CB	720	9588M	725
941/S	113	960EPC/L	121	985/B7	124	9541BIKE	718	9588S/10...	725
942BX	113	960E-PI/P	121	985F	125	9541F	718	9589A/36	726
942BX/DG	611	960ER	119	985M	125	9541PC	718	9589B/36	726
942BX/S	113	960F	119	986 48	125	9541S	718	9590B	722
943BX	114	960G	119	986 78	125	9542AL	721	9592B/C50	724
943BX/D	114	960H/C4	119	986PT	125	9542AT	720	9592B/P	724
943BX/DG	611	960KC-M8/M9/M10	121	987	125	9542C	720	9592M/50	724
943BX/S	114	960KPC	121	987AR	125	9542G	720	9592MB	724
943BXK	600	960L	119	987P	125	9542GW	720	9593A	717
943FL	114	960M	119	988/K4	125	9542M	720	9593M	717
943FL/S	114	960P	121	989	125	9542S	720	9593S	717
943MQ	288	960PI	121	989A	125	9543C	721	9593SB	717
943MQ/BG	611	960PI/C19	122	989B	125	9544C	717	9593W	717
943MQ/S	288	960PI/K36	122	990	126	9547	724	9594	724
944BX	114	960PI/S	122	991	126	9547T	721	9595C	725
944BX/D	114	960PMC	122	992	126	9547WSK	721	9595T	725
944BX/DG	611			993	126	9548G	722		

ALFANUMERISCHE INDEX

9596	725	C39/7	391	C45PRO PM	472	C55P/2MDX-SX	427	CB/2	561
9597P	721	C39/8	392	C45PRO PML	473	C55P/MCD	427	CB52	400
9597TRIOWAY	719	C39MD	394	C45PRO RD/X	467	C55PB/3	413	CD23S	369
9598WHP-N	719	C39SM	394	C45PRO SL	470	C55PB-PRO/7	414	CP	477
9598W-N	719	C39T	392	C45PRO SS	470	C55PB-PRO/8	414	CP15 - 2115	361
9599CB-N2	719	C41H	395	C45PRO T3	469	C55PFA-0,8	429	CP15L - 2115	361
9599CB-WN	719	C41H/CE	395	C45PRO TC	469	C55PFA-1,0	427	CP17 - CP17L - 2117	362
9881U	261	C41S	395	C45PRO W	457	C55PM	427	CP51	400
9882R	261	C42H	396	C45PRO X	456	C55PM/M0,8	429	CPMB/3C	476
9899 CV/A	111	C45PRO A1/R600	473	C45PW/1-0,7MT	463	C55PRO B/2	415	CPMB/5C	477
9899 CV/B	111	C45PRO A1/RB600	474	C45PW/2-1,3MT	464	C55PRO B/2,8	416	CX49-G	397
9899 CV/C	111	C45PRO A2/R915	474	C45PW/3-2,0MT	464	C55PRO B-D4	417		
		C45PRO ACT	469	C45PX/1-0,7MT	463	C55PS	430		
		C45PRO AS1	473	C45PX/2-1,3MT	464	C55PSE	430		
		C45PRO AS2	474	C45PX/3-2,0MT	464	C55PT0,8x0,6	429		
C04TSS-7	380	C45PRO AW	458	C45STR	474	C55PT1,0x0,6	428		
C3	358	C45PRO AX	458	C48M	398	C55PTE-0,8	429		
C4 - 2104	358	C45PRO BPW-1,3	461	C48P	398	C55PTE-1,0	428		
C5 - 2105	358	C45PRO BPW-2,0	461	C51	399	C55RB	420		
C5S	358	C45PRO BPX-1,3	461	C54S	402	C55STR	435		
C6T - 2106	358	C45PRO BPX-2,0	460	C55	412	C55T3	426		
C7 - 2107	358	C45PRO BW	459	C55 A1/RB42	433	C56	406		
C7AT	359	C45PRO BX	458	C55/1PF	429	C56B	406		
C8 - 2108	359	C45PRO C5	464	C55/2PM	428	C56M	407		
C8B	359	C45PRO C7	465	C55/PF	427	C56P O	401		
C9 - 2109	359	C45PRO CAI/W	472	C55/PL-1,024	420	C56PL O	401		
C9/RT	359	C45PRO CAI/X	472	C55A1	433	C56W	406		
C9DA	359	C45PRO CORNER/W	472	C55A1/R42	433	C57SA	403		
C9MT	360	C45PRO CORNER/X	471	C55A2	434	C57SB	404		
C9PT	321	C45PRO CPF	463	C55A2/R70	434	C57SC	404		
C10 - 2110	360	C45PRO CW	460	C55AB	413	C57SD	403		
C10S - 2110S	360	C45PRO CX	460	C55AC	431	C57SP	405		
C11 - 2111	360	C45PRO DX	455	C55AE	430	C58B	407		
C12 - 2112	361	C45PRO DW	454	C55AT1	435	C58M	407		
C13	361	C45PRO EW	459	C55AT2	435	C58P	405		
C14	361	C45PRO EX	459	C55B PT/2	420	C59A	408		
C16 - 2116	362	C45PRO FW	455	C55B PT/2,8	420	C59B	408		
C18 - 2118	362	C45PRO FX	455	C55B/1	432	C59C	409		
C19-2119-C19L-2119L	362	C45PRO GW	456	C55B/2	415	C62M/WW	669		
C20 - C20L - 2120	362	C45PRO GX	456	C55B/2,8	416	C64/1	669		
C20TSS	363	C45PRO HW	457	C55B/G	418	C64CW	670		
C22B	363	C45PRO HX	457	C55B/GAA	418	C64G/1	670		
C22P	363	C45PRO M3A	468	C55B/GAE	419	C68	615		
C22W	363	C45PRO M4	465	C55B/GDP	418	C68 G	615		
C25	380	C45PRO M5	465	C55B/GDS	418	C68N	615		
C27S	381	C45PRO M7	466	C55B/GE	419	C88 R/1	615		
C30M	383	C45PRO M7A/W	462	C55B/VS	420	C88NR/1	615		
C35/6GM	384	C45PRO M7A/X	462	C55B-D4	417	C88SE	615		
C35/7GM	385	C45PRO M8	466	C55C7	421	C88VE	615		
C35/8GM	385	C45PRO MA	467	C55C8	422	C99	364		
C35/9GM	385	C45PRO MAL	467	C55CS	424	C99C-V3	367		
C37/6	387	C45PRO MAT	468	C55KAI	431	C99P	367		
C37/7	386	C45PRO ML	468	C55KAS	431	C99P12-V0	365		
C37/8	387	C45PRO MP	471	C55M2	422	C99PC	367		
C37A/7	387	C45PRO MS	466	C55M4	423	C99PP	367		
C38	389	C45PRO MWS/W	463	C55M7	423	C99V0	364		
C38C	390	C45PRO MWS/X	462	C55M8	424	C99V0-P12	365		
C38L	389	C45PRO PAS	470	C55MA	425	C99V1	365		
C38L A	389	C45PRO PF	470	C55MDO	425	C99V2	366		
C38T	390	C45PRO PFE	471	C55MP	431	C99V3/2C	366		
C39/6	392			C55MS	426	CA49-G	397		
								G,K	
								GM	560
								KIT 6VC/3C	476
								KIT 10VC/5C	477
								KIT/GPS	560
								M	
								M01	533
								M02	533
								M05	533
								M06	533
								M13	533
								M25	533
								M30	533
								M31	534
								M33	534
								M38	534
								M39	534
								M40	534
								M44	534
								M45	534
								M46	534
								M49	534
								M50	534
								M52	535
								M53	535
								M55	535
								M60	535
								M62	535
								M63	535
								M65	535
								M67	535
								M69	535
								M75	535
								M78	536
								M79	536
								M82	536
								M83	536
								M85	536
								M86	536
								M91	536
								M92	536
								M94	536
								M96	536
								M100	537
								M105	537
								M108	537
								M110	537
								M112	537

ALFANUMERISCHE INDEX

M115	537	MB58	545	RSC50 CS	447	T34	550	T177	555
M120	538	MB59	545	RSC50 D	440	T40	550	T180	555
M121	538	MB63	546	RSC50 E	440	T41	550	T183	555
M125	538	MB64	546	RSC50 F	440	T45	550	T198	555
M126	538	MB65	545	RSC50 G	439	T46	550	T199	555
M127	538	MC10	543	RSC50 H	439	T48	550	T201	555
M128	538	MC12	543	RSC50 I	438	T50	550	T202	555
M129	538	MC20	543	RSC50 KAI	451	T52	550	T204	555
M133	538	MC21	543	RSC50 KPF	449	T55	550	T205	556
M134	538	MM11	546	RSC50 L	438	T59	550	T206	556
M135	539	MM26	546	RSC50 M10	445	T63	550	T207	556
M136	539	MM30	546	RSC50 M4	444	T64	551	T208	556
M137	539	MM60	546	RSC50 M5	444	T65	551	T209	556
M145	539	MM63	546	RSC50 M7	445	T68	551	T211	556
M153	539	MM100	547	RSC50 M8	445	T73	551	T213	556
M161	539	MM105	547	RSC50 MA	447	T75	551	T216	556
M162	539	MM129	547	RSC50 MDO	448	T76	551	T221	556
M166	539	MM210	547	RSC50 ML	447	T77	551	T226	556
M170	539	MM230	548	RSC50 MS-2AVV	446	T80	551	T227	556
M172	539	MM400	548	RSC50 MS-2C	446	T81	551	T228	556
M174	540	MM401	548	RSC50 MS-AVV	446	T82	551	T231	557
M180	540	P		RSC50 MTP	450	T83	551	T233	557
M195	540			RSC50 P/1-0,7MT	442	T85	552	T234	557
M201	540	PM 1/2-Q5	72	RSC50 P/2-1,5MT	442	T91	552	T236	557
M204	540	PM/5C	477	RSC50 P/2MDX-SX	450	T92	552	T239	557
M208	540	PM/6C	477	RSC50 P/3-2,2MT	442	T99	552	T241	557
M209	540	PV	405	RSC50 PFI	449	T100	552	T259	557
M213	540	R		RSC50 PFS	449	T101	552	T264	557
M214	540			RSC50 PM	450	T102	552	T270	557
M216	540		RSC50 PS	451	T103	552	T273	557	
M217	540	RSC22	368	RSC50 RB	443	T105	552	T279	558
M218	541	RSC23	369	RSC50 T3	448	T106	552	T281	557
M219	541	RSC23C	369	RSC51	399	T111	552	T284	558
M222	541	RSC23T	370	S		T112	553	T291	558
M226	541	RSC24/5	372				T113	553	T294
M227	541	RSC24/6	372	S42/17	561	T122	553	T297	558
M230	541	RSC24/7	371	S55/12	560	T123	553	TSPP	560
M231	541	RSC24/8	372	S55/8	560	T124	553	V	
M234	541	RSC24A/6	373	S951/6	561	T135	553		
M236	541	RSC24A/7	373	S952/10	560	T136	553	VE1	560
M237	542	RSC24A/8	373	S96T/8	561	T137	553	VP-3SC	559
M240	542	RSC24AXL/7	374	S1719BM	561	T138	553	VP-LD	559
M264	542	RSC24AXL/8	375	SB	560	T140	553	VP-LS	559
M284	542	RSC24AXL/9	375	SGN	561	T144	553	VP1 - VP2	559
M292	542	RSC24AXLP/7	376	SP5S	478	T145	553	VP3 - VP4	559
M294	542	RSC24L/7	379	SPC	478	T146	554	VP5	559
M295	542	RSC24L-CAB	379	SPG11 - S1203/8	561	T151	554	VP6	559
M305	542	RSC28	382	SSPE	473	T153	554	VPM0	548
M310	542	RSC50	439	ST2P	560	T156	554	VPM3	548
M400	543	RSC50 A	441	T		T157	554	VPM7	548
M401	543	RSC50 A1	452				T160	554	VPM7-C
MB	560	RSC50 A1/R59	452	T01	549	T161	554	VPM8	548
MB12	544	RSC50 A1/RB59	452	T05	549	T164	554	VPM9	548
MB37	544	RSC50 A2	452	T06	549	T167	554		
MB38	544	RSC50 A2/R91	453	T18	549	T168	554		
MB39	544	RSC50 AC	451	T19	549	T170	554		
MB44	544	RSC50 B	441	T22	549	T171	554		
MB45	545	RSC50 C	441	T23	549	T172	555		
MB46	545	RSC50 C5	443	T31	549	T173	555		
MB47	545	RSC50 C7	443	T33	550	T175	555		
MB56	545	RSC50 C8	444			T176	555		

BETA-GROEP

BELANGRIJKSTE FEITEN



www.gruppo-beta.com



10 productie-eenheden in Italië



Ongeveer **1.000** medewerkers

11 vestigingen wereldwijd

Actief in meer dan **100 landen** wereldwijd, met meer dan **250 importeurs**



BETA UTENSILI S.p.A. - 20845 Sovico (MB)
Via A.Volta, 18 - Tel. 039.2077.1 - Fax 039.2010742
www.beta-tools.com

Robur Wire rope accessories:
67039 Sulmona (AQ) Zona industriale - C.da S. Nicola
Tel. 0864.2504.1 - Fax 0864.253132
www.roburitaly.com - info@roburitaly.com

DE GESCHIEDENIS VAN ITALIAANSE GEREEDSCHAPPEN

- 1923** ● Alessandro Ciceri richtte "Alessandro Ciceri & Figli" op in Erba (in de provincie Como) om gietijzeren en stalen gietstukken te vervaardigen.
- 1939** ● Het handelsmerk Beta werd geregistreerd en het bedrijf hield zich voornamelijk bezig met de productie van professioneel gereedschap in de fabriek in Sovico (in de provincie Monza e Brianza). Het bedrijf is nog steeds gevestigd in Sovico.
- 1960** ● Beta Utensili had maar liefst tweehonderd mensen in dienst, vestigde zich als een opkomende fabrikant van professioneel handgereedschap en exporteerde hun producten.
- 1969** ● De revolutionaire oranje plaatstalen "Tank"-trolley werd gelanceerd; vanaf dat moment zou oranje resulteren in een unieke stijl voor het handelsmerk Beta.
- 1971** ● Beta Utensili betrad de autosportwereld – eerst in de Formule 1 en daarna in de rallysport en de autosport in het algemeen.
- 1973** ● De fabriek in Castiglione d'Adda (in de provincie Lodi) werd geopend en sloot zich daarmee aan bij de gevestigde fabriek in Sovico (in de provincie Monza e Brianza).
- 1975** ● Het bedrijf behaalde hun eerste Formule 1-overwinning met de oranje March-Beta Utensili, bestuurd door Vittorio Brambilla, die in de stormende regen de Grand Prix van Oostenrijk in Zeltweg won.
- 1980** ● Beta Utensili drong verder door op de belangrijkste Europese markten en vestigde vestigingen in Frankrijk, Groot-Brittannië, Nederland, Spanje, Polen en Hongarije.
- 1984** ● Het bedrijf opende hun derde fabriek in Sulmona (in de provincie L'Aquila). In de smederij begonnen ze met de productie van de iconische combinatiesleutels, artikel 42. De productie en het testen van hijsaccessoires begon onder de merknaam Robur.
- 2000** ● De lancering van de nieuwe Beta Utensili-catalogus getuigde van aanhoudende groei. Het assortiment beschikbare producten werd verdubbeld en de ruim 10.000 gecodeerde artikelen werden onderverdeeld in 22 productfamilies
- 2002** ● Het assortiment van Beta Utensili werd verder uitgebreid en aangevuld met veiligheidsschoenen en met de werk- en vrijetijdskledingcollectie "Beta Work".
- 2009** ● Beta begon zich in het buitenland uit te breiden en richtte Beta China op en drie jaar later Beta Brazilië
- 2016** ● Beta introduceerde de nieuwe modulaire werkplaatsinrichting, RSC55.
- 2018** ● De Beta Group heeft zich verder gevestigd door de overname van BM S.p.A., een toonaangevende fabrikant van kabelschoenen en elektrische verbindingssystemen, 3D Beta S.r.l., een bedrijf gespecialiseerd in het ontwerp en de productie van op maat gemaakte werkplaatsinrichtingen, en VGF S.r.l., een bedrijf gespecialiseerd in bij het poedercoaten van metalen meubelen.
- 2019** ● De groei strategie van de Beta Group werd versneld met de overname van de toonaangevende producenten van schuurmiddelen, Abra Beta S.p.A. en Elpa Abrasivi S.r.l.
- 2020** ● Beta Tools USA werd opgericht als een belangrijke stap in de richting van expansie op de Noord-Amerikaanse markt.
- 2023** ● Het bedrijf nam Helvi S.p.A. over, een belangrijke speler in de metaallasindustrie. Daarom kan de Beta Group nu meer dan 1.000 medewerkers wereldwijd, 40 productfamilies en meer dan 30.000 gecodeerde artikelen tellen, ontwikkeld om aan de eisen van professionals te voldoen en op lange termijn kwaliteit en prestaties te leveren, volgens het principe 'Beta Well Done', omdat wij bij Beta alleen dingen goed willen doen.



1923 Alessandro Ciceri & Figli



1939 Smederij



1955 Metaalbewerkings afdeling

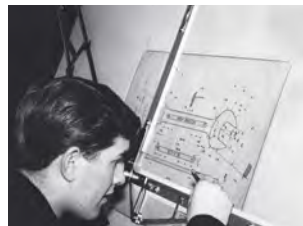

1960 Design afdeling

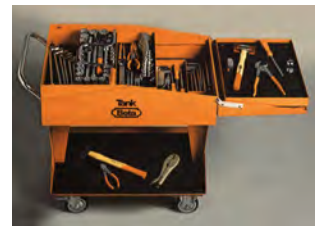

1969 Tank gereedschapswagen



1974 Advertentie voor gereedschap assortimenten



1975 Vittorio Brambilla



2002 "BetaWork"

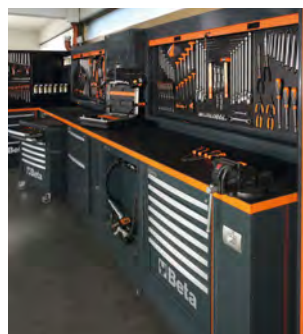

2016 Werkplaatsinrichting RC55



2023 Fabio Quartararo, Beta ambassadeur

CERTIFIED QUALITY

Beta liet haar kwaliteitssysteem al in 1995 certificeren volgens de ISO 9001-normen; in 2018 behaalde het bedrijf de **TÜV**-certificering door strenge tests te ondergaan volgens het EK5/TA5-testprotocol.

Protocol EK5/TA5 bevat 31 duidelijk omschreven constructie kenmerken, strenge statische testen en dynamische gedragstesten. Andere testen bepalen de weerstand tegen hoge en lage temperaturen, de duurzaamheid van de markering na verloop van tijd en de corrosiebestendigheid.

Een belangrijk deel voor het behalen van deze prestatie is het deskundig ontwerp, een nauwkeurige fabricatie en ons vertrouwen in het strenge testen van de gereedschap wagens, waardoor de kwaliteit zijn erkenning krijgt bij de eindgebruiker.



CONTROLE EN KWALITEIT

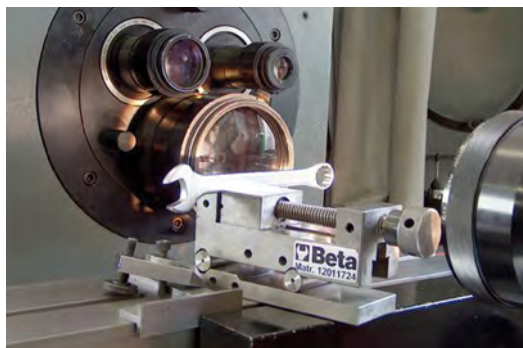

Bij Beta, kwaliteit heeft een eenvoudig concrete betekenis: "is datgene wat volledig voldoet aan de eisen en verwachtingen van de professionele gebruiker, welke afhankelijk zijn aan onze producten als een onvervangbaar werkinstrument".

Gereedschappen zijn niet uitsluitend ontworpen en correct gefabriceerd om aan een vraag te voldoen, maar moeten eveneens een langdurige consistente werking garanderen. Bij Beta, waar kwaliteit verder gaat dan alleen een attente industriële en verkooppolitiek, is elke bedrijfsafdeling ervan doordrongen, elke keer weer de ambitieuze doelstelling te halen op het gebied van klant tevredenheid. Beta heeft haar geschiedenis opgebouwd op dit concept.

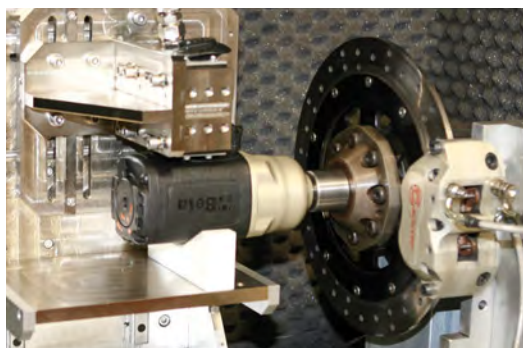

**Beta kwaliteit,
ons meest
concrete
bewijs**

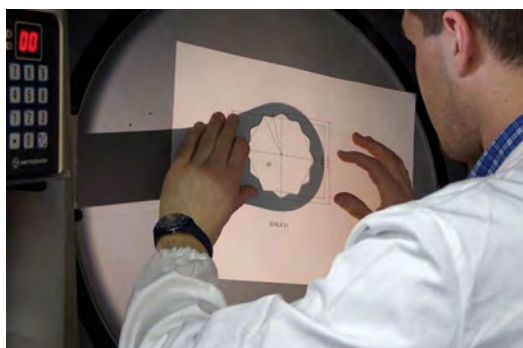

**De kwaliteit van Beta
gereedschappen
is de synergie van oude
ambachtelijke
technieken en nieuwe
technologie.**



Sinds 1995 zijn onze productie processen conform de normen volgens ISO 9001 Kwaliteit Systeem standaards



LOGISTICS



**30.000 m²
oppervlakte**



40.000
gecodeerde artikelen
en meer dan **27.000**
Laadeenheden



**Snel, nauwkeurig
en complete
leveringen**



WERKPLAATS INRICHTING

5S is een werkplaats organisatie methode van Japanse oorsprong. De naam is het gevolg van de westerse vertaling van de 5 Japanse woorden: **seiri, seiton, seiso, seiketsu en shitsuke**.

Het volgen van de 5 stappen aan de hand van deze woorden maakt het mogelijk een systematische herhaalbare methode te implementeren om beter inzicht te krijgen voor het optimaliseren arbeidsprocessen en het verhogen productiviteit.



SEIRI

SORTEREN

Verwijder alle onnodige delen van uit de werkplaats; sorteer alleen de delen die men nodig heeft.



SEITON

SCHIKKEN

Plaats alles op de juiste plek: een geschikte plek voor alles en alles op zijn geschikte plek.



SEISO

SCHOONMAKEN

Hou de werkplaats schoon en opgeruimd.



SEIKETSU

STANDAARDISEREN

Leg vast een consistente werkprocedure, voor het rationaliseren van bronnen en ruimten, om een standaard te implementeren.



SHITSUKE

STANDHOUDEN

Ondersteun en deel deze denkwijze en gedrag binnen de gehele organisatie.



BENEFITS



Tijdsbesparing en verbeterde productiviteit



Betere kwaliteit en productiviteit



Minder arbeidsongelukken



Grotere efficiëntie



NA



VOOR

EFFECTIEVE AANWEZIGHEID

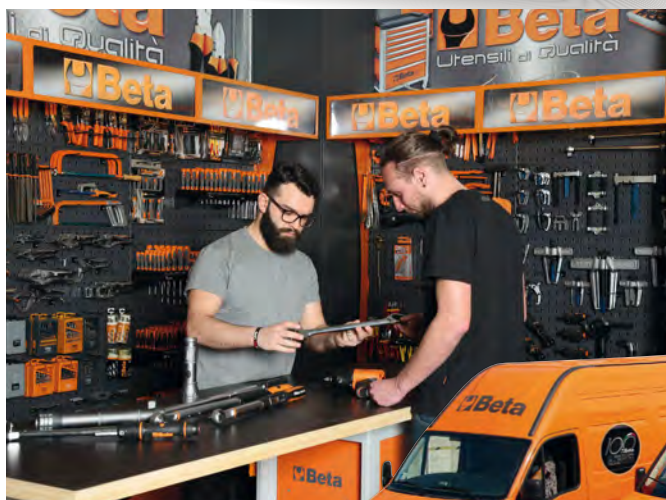

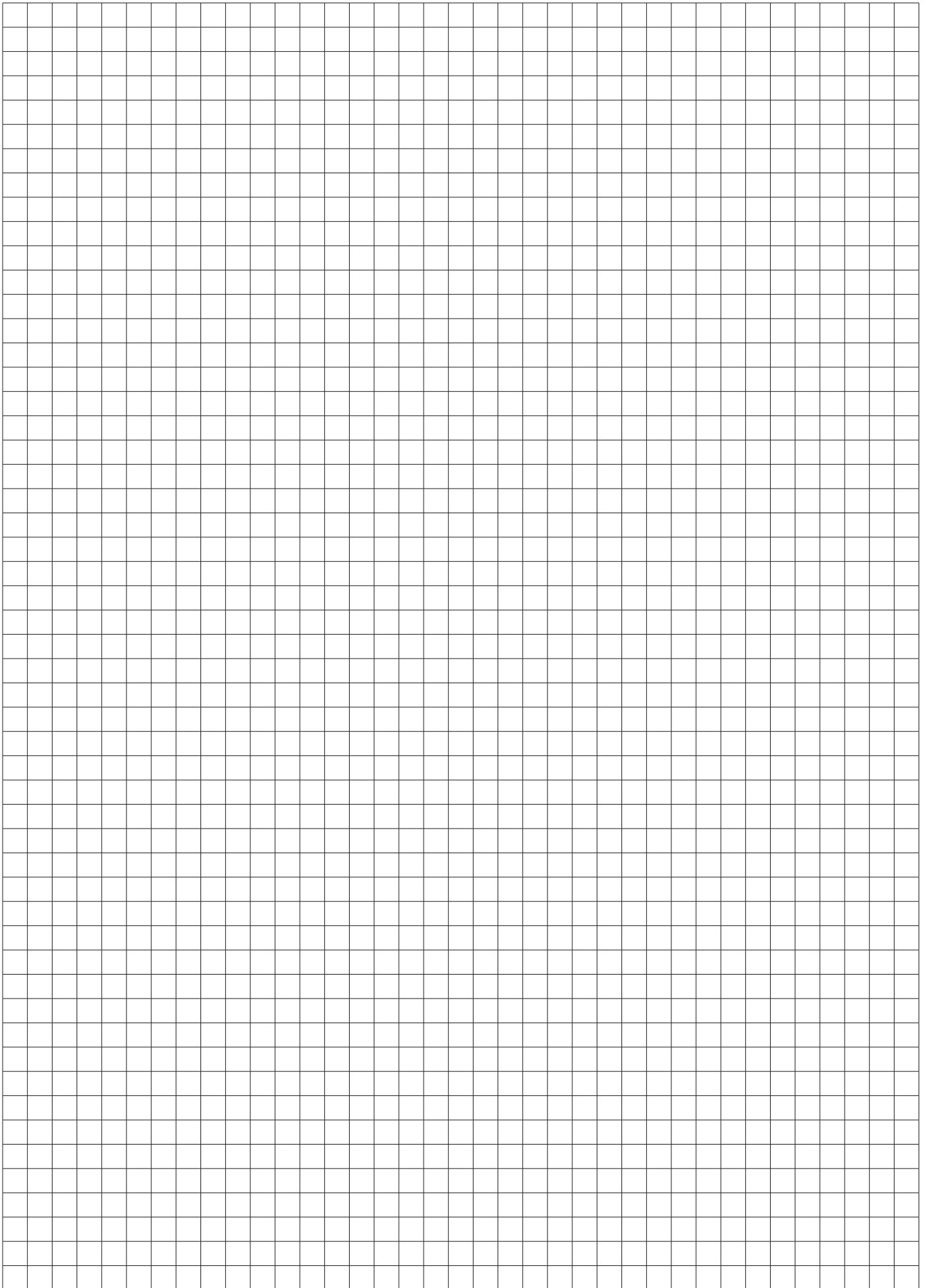

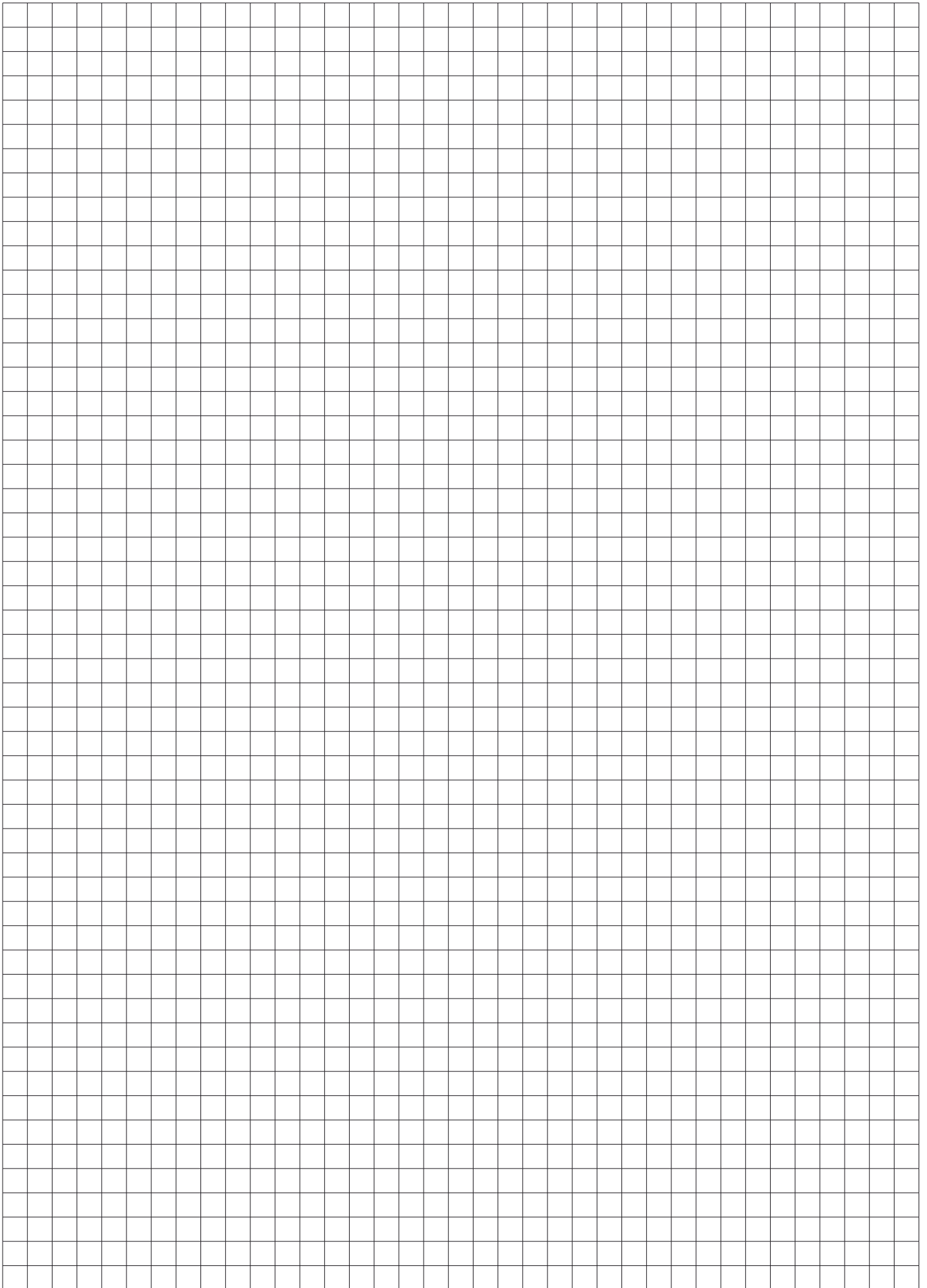

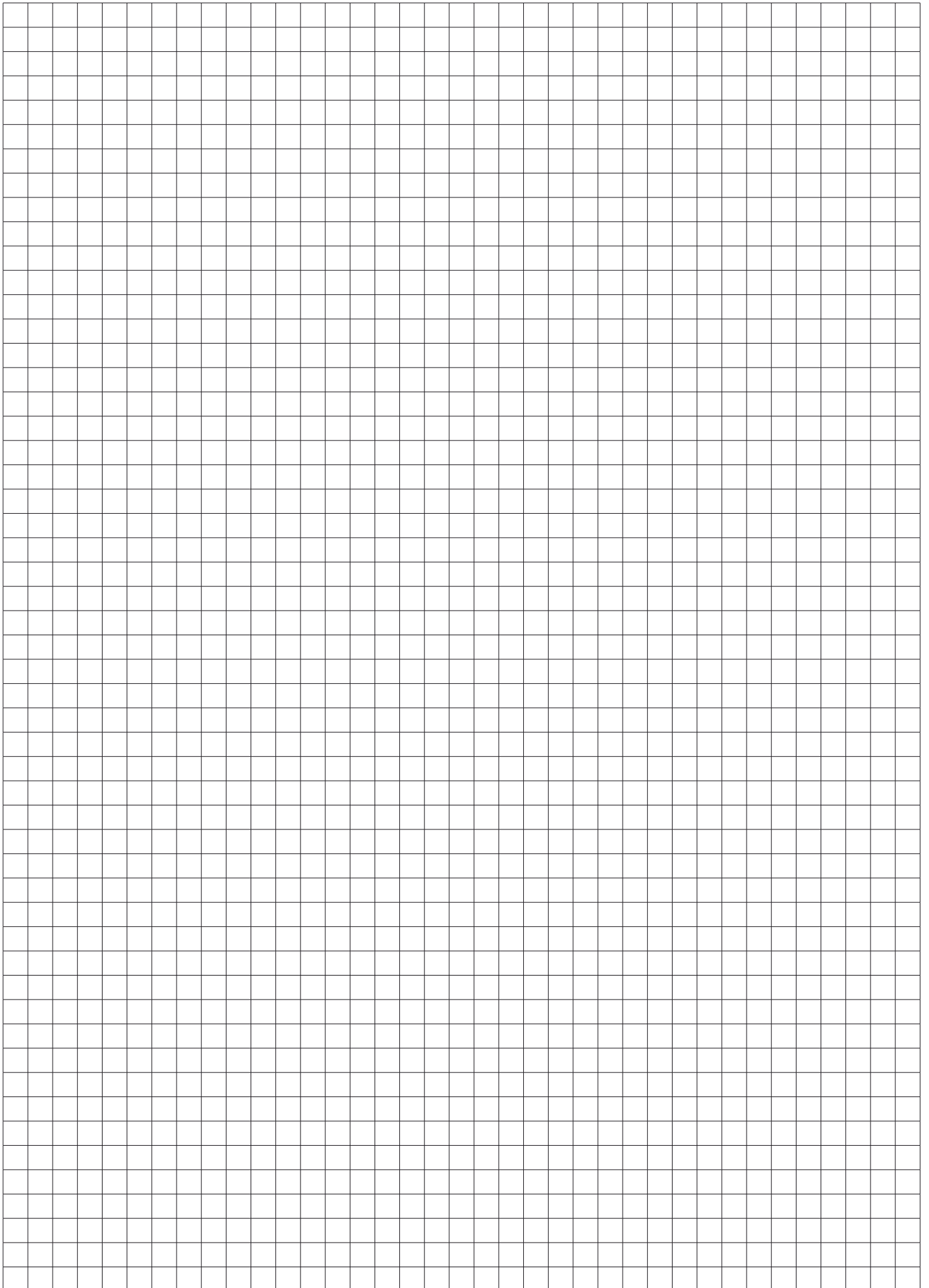

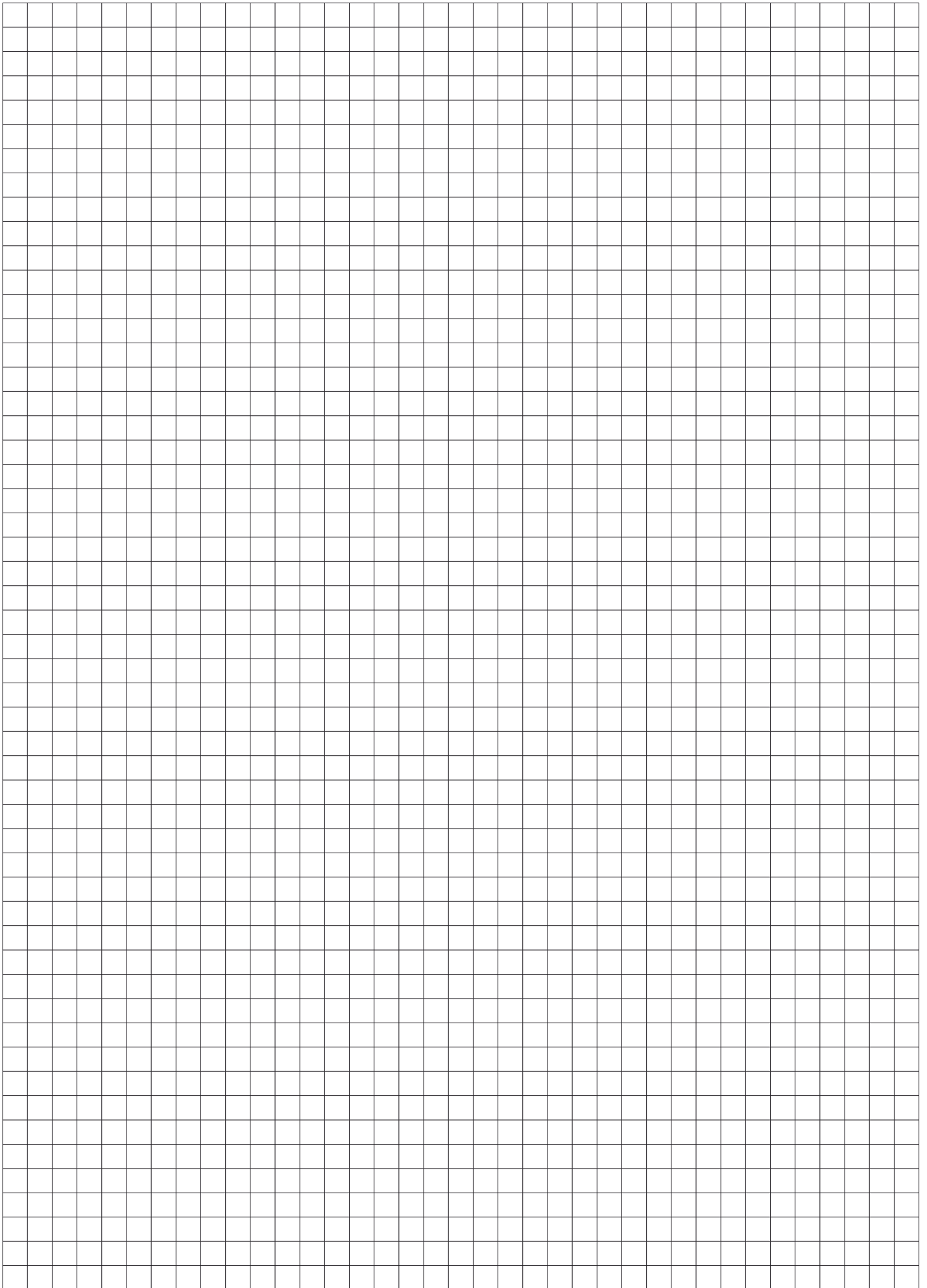

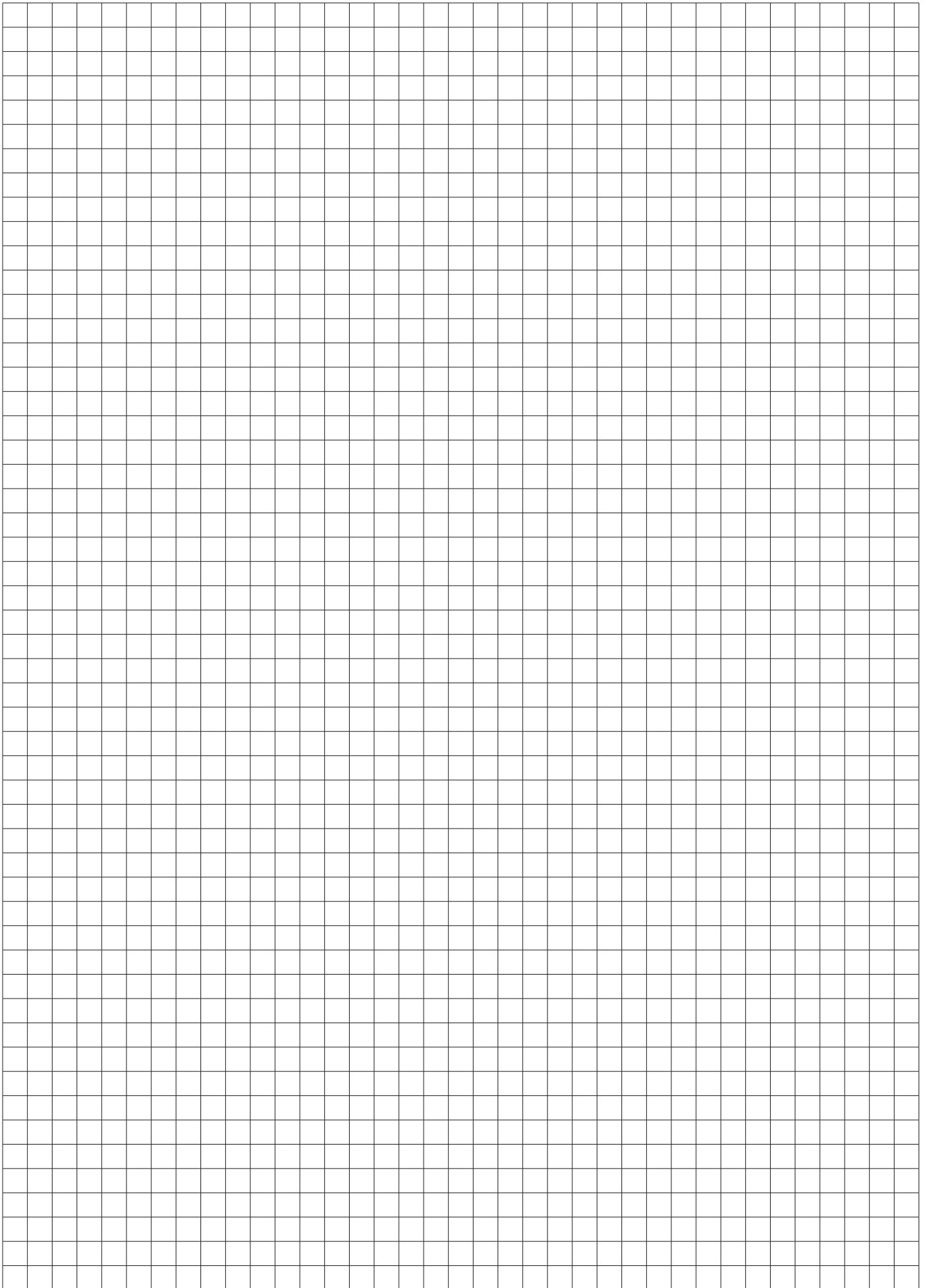

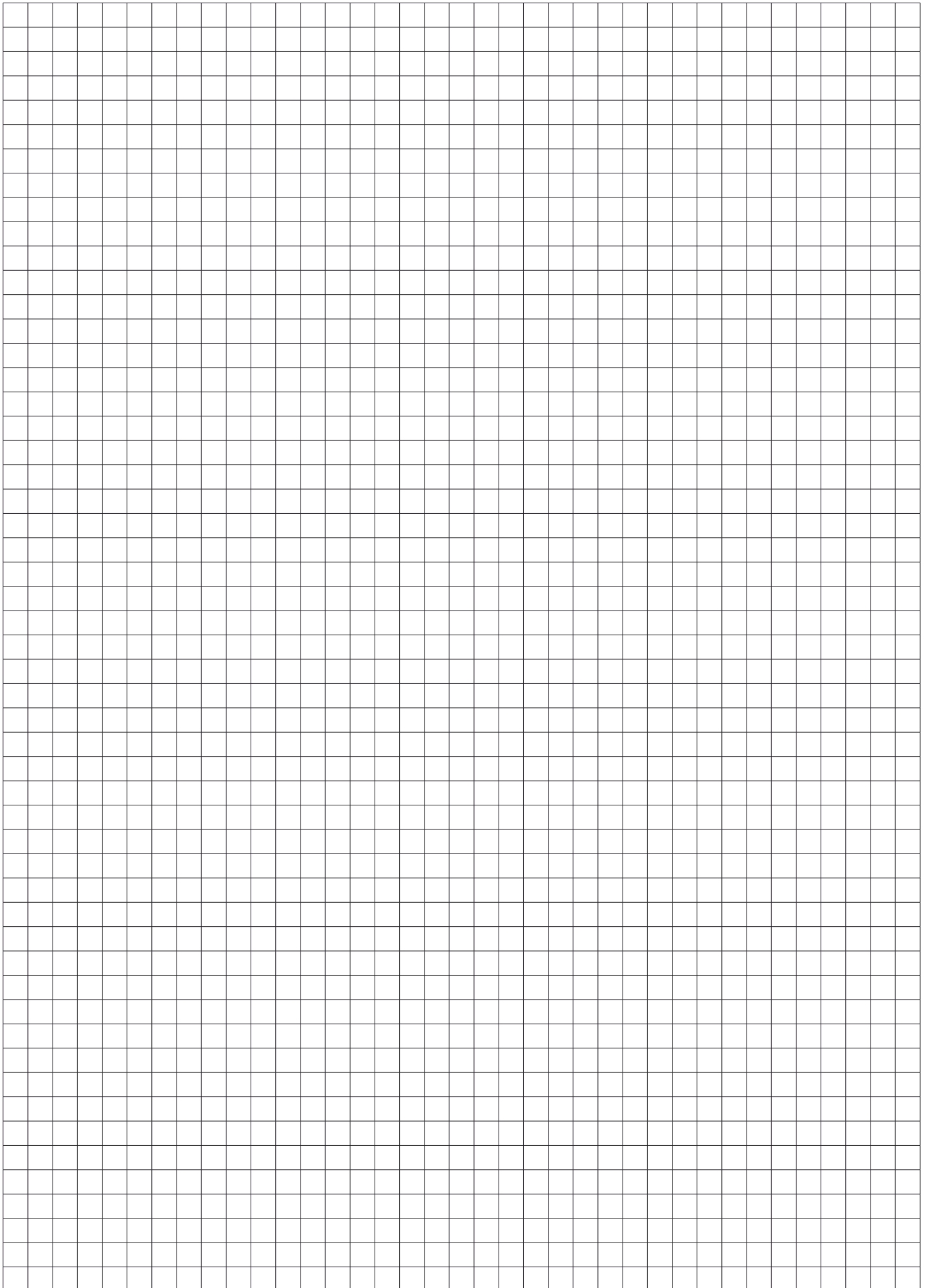

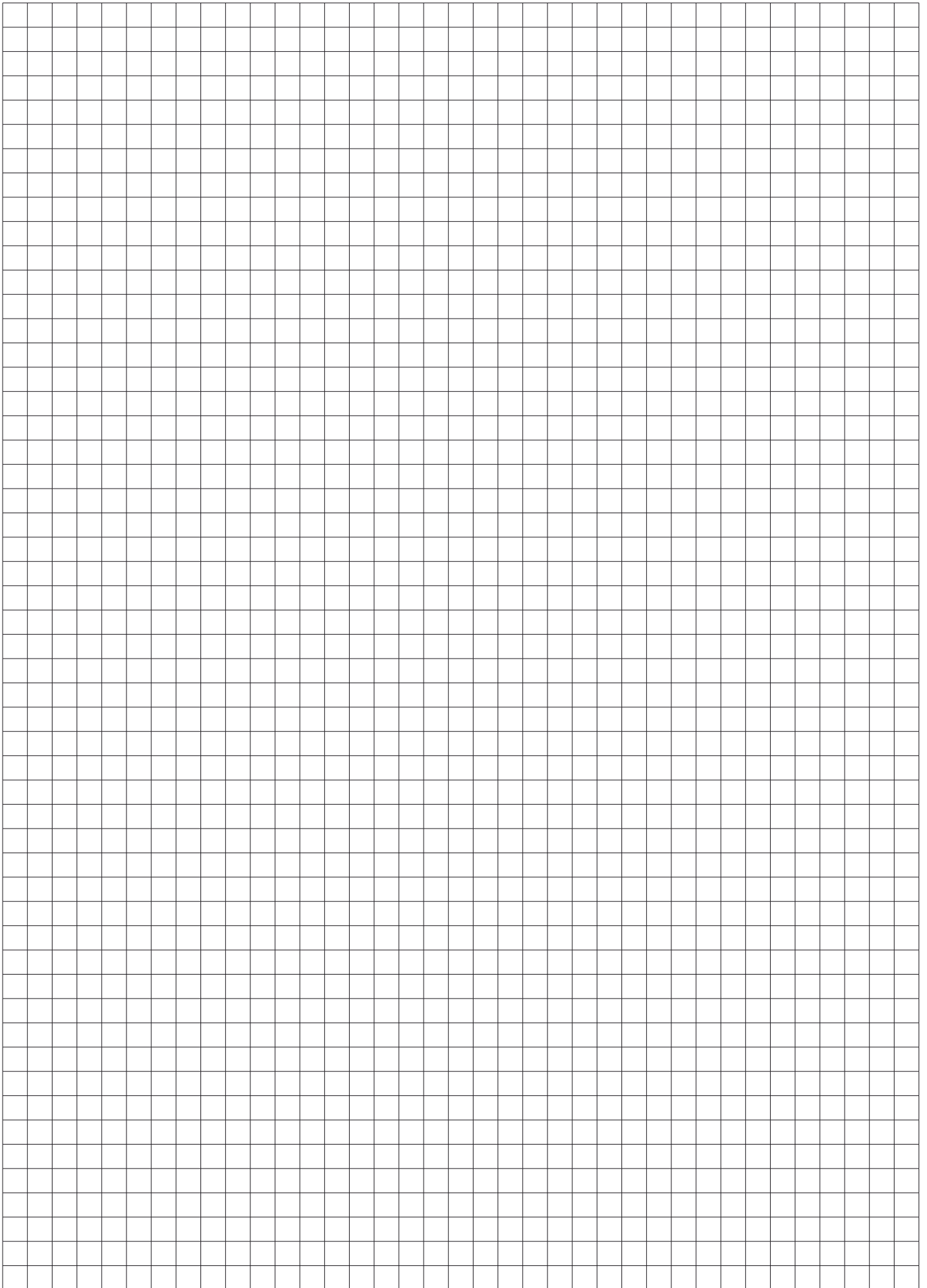

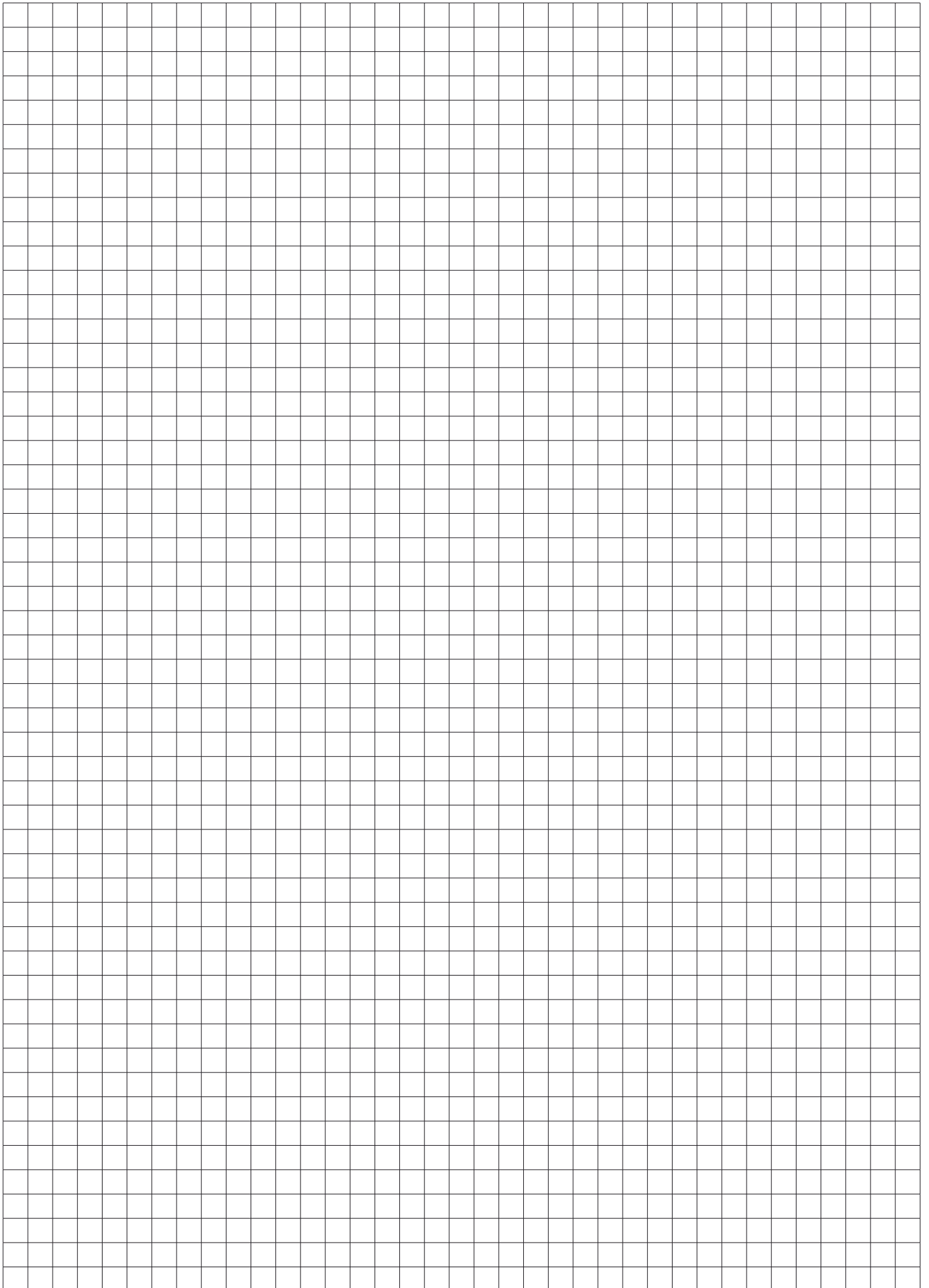

2023 Moto2
World Championship



FERMÍN
ALDEGUER

 **Beta**

50 Years in Motorsports

2023

PARTNERSHIP



 **Beta**
AMBASSADOR

FABIO QUARTARARO
2023 MotoGP
World Championship



Technical
Partner

